



**THE DATASHEET OF  
AS13985H18-T**



# AS13985

## Micropower 150mA Low-Noise LDO

### 1 General Description

The AS13985 is a high-performance low-dropout 150mA voltage regulator designed for use with very-low ESR output capacitors. The device can deliver superior performance in all specifications critical to battery-powered designs, and is perfectly suited for mobile phones, PDAs, MP3 players, and other battery powered devices.

Stability is guaranteed with a ceramic output capacitor from 1 to 22 $\mu$ F. The low equivalent series resistance of these capacitors ensures low output impedance at high frequencies.

Automatic sleep mode requires less than 1 $\mu$ A quiescent current when pin EN is pulled low.

Regulation performance is excellent even under low dropout conditions, when the power transistor has to operate in linear mode.

A 10nF bypass capacitor can be added to reduce output noise to 30 $\mu$ V. The low-noise performance allows direct connection of noise sensitive circuits without additional filtering networks.

Multiple output voltage options are available as standard products. Contact austriamicrosystems AG for details.

The AS13985 is available in a 5-bump WLP package and a 5-pin SOT23 package.

### 2 Key Features

- Ultra-Low Dropout Voltage (typically 45mV @ 150mA, 0.3mV @ 1mA)
- Supply Range: 2.5V to 5.5V
- Output Voltage Range: 1.2V to 5.0V (in 25mV Steps)
- Output Current: 150mA (Guaranteed)
- Stable with Low-ESR Output Capacitor
- Integrated Over-Temperature/Over-Current Protection
- Low GND Pin Current (only 95 $\mu$ A)
- Output Voltage Accuracy: 1%
- Minimal External Components Required
- High Peak-Current Capability
- Low Shutdown Current:  $\leq$ 1 $\mu$ A
- Operating Temperature Junction Range: -40 to +125 $^{\circ}$ C
- Smallest Available Packages:
  - 5-bump WLP
  - 5-pin SOT23

### 3 Applications

The AS13985 is ideal for powering cordless and mobile phones, MP3 players, CD and DVD players, PDAs, hand-held computers, digital cameras, and any other hand-held battery-powered device.

Figure 1. AS13985 - Block Diagram

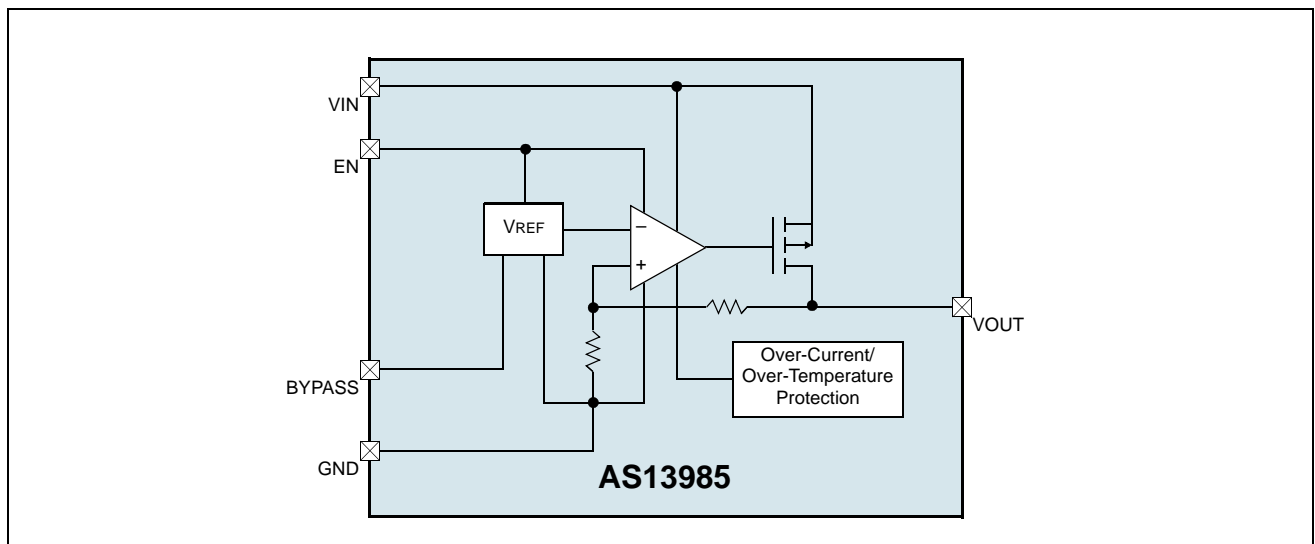

## 4 Pinout

### 4.1 Pin Assignments

Figure 2. Pin Assignments (Top View)

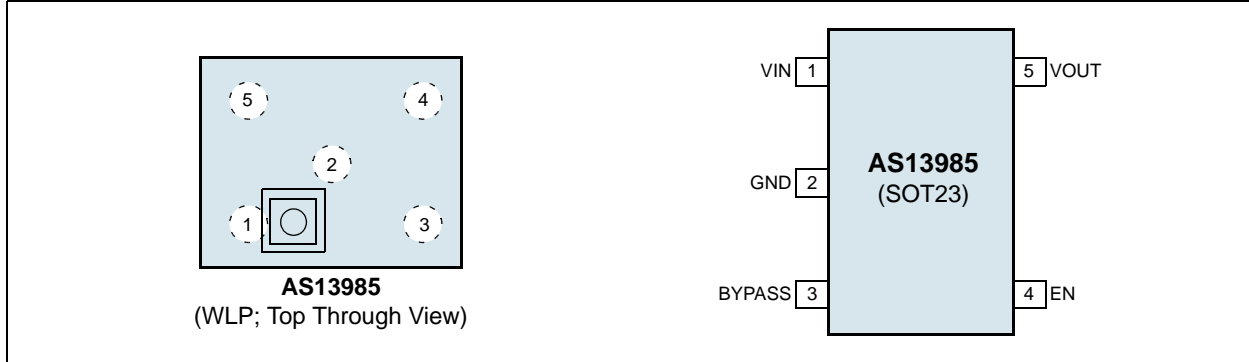

### 4.2 Pin Descriptions

Table 1. Pin Descriptions

Name	WLP	SOT23	Description
VIN	4	1	<b>Input Voltage</b>
GND	2	2	<b>Ground</b>
BYPASS	5	3	<b>Low-Noise Operation Bypass Capacitor</b>
EN	1	4	<b>Logic-High Enable Input.</b> $V_{EN} \geq 1.2V$ : VOUT is enabled. $V_{EN} \leq 0.4V$ : VOUT is disabled.
VOUT	3	5	<b>Regulated Output Voltage</b>

## 5 Absolute Maximum Ratings

Stresses beyond those listed in Table 2 may cause permanent damage to the device. These are stress ratings only, and functional operation of the device at these or any other conditions beyond those indicated in Section 6 Electrical Characteristics on page 4 is not implied. Exposure to absolute maximum rating conditions for extended periods may affect device reliability.

Table 2. Absolute Maximum Ratings

Parameter	Min	Max	Units	Comments
Input Supply Voltage (Survival)	-0.3	+7	V	
Input Supply Voltage (Operating)	+2.5	+5.5	V	
Shutdown Input Voltage (Survival)	-0.3	+7	V	
Output Voltage (Survival)	-0.3	+7	V	
I <sub>OUT</sub> (Survival)				Short-circuit protected.
Input/Output Voltage (Survival) <sup>1</sup>	-0.3	+7	V	
Power Dissipation <sup>2</sup>				Internally limited.
Operating Junction Temperature	-40	+125	°C	
Storage Temperature Range	-65	+150	°C	
Package Body Temperature		+260	°C	The reflow peak soldering temperature (body temperature) specified is in accordance with IPC/JEDEC J-STD-020D "Moisture/Reflow Sensitivity Classification for Non-Hermetic Solid State Surface Mount Devices". The lead finish for Pb-free leaded packages is matte tin (100% Sn).

1. The output PNP structure contains a diode between pins V<sub>IN</sub> and V<sub>OUT</sub> that is normally reverse-biased. reversing the polarity of pins V<sub>IN</sub> and V<sub>OUT</sub> will activate this diode.
2. The maximum allowable power dissipation is a function of the maximum junction temperature (T<sub>J(MAX)</sub>), the junction-to-ambient thermal resistance (Θ<sub>JA</sub>), and the ambient temperature (T<sub>AMB</sub>). The maximum allowable power dissipation at any ambient temperature is calculated as:

$$P_{(MAX)} = (T_{J(MAX)} - T_{AMB}) / \Theta_{JA} \quad (EQ 1)$$

**Where:**

The value of Θ<sub>JA</sub> for the SOT23 package is 220°C/W in a typical PC-board mounting.

The value of Θ<sub>JA</sub> for the WLP package is 225°C/W.

**Note:** Exceeding the maximum allowable dissipation will cause excessive device temperature and the regulator will go into thermal shutdown.

## 6 Electrical Characteristics

$T_{AMB} = 25^{\circ}\text{C}$ ,  $V_{IN} = V_{OUT(NOM)} + 0.5\text{V}$ ,  $C_{OUT} = C_{IN} = 1\mu\text{F}$ ,  $C_{BYPASS} = 10\text{nF}$ ,  $I_{OUT} = 1\text{mA}$ ,  $V_{EN} = 1.4\text{V}$  (unless otherwise specified)

**Caution:** Exposing the WLP package to direct light could cause device malfunction.

Table 3. Electrical Characteristics

Symbol	Parameter	Conditions	Min	Typ	Max	Unit	
$V_{IN}$	Operating Input Voltage		2.5		5.5	V	
$V_{OUT(NOM)} - V_{OUT}$	Output Voltage Accuracy < 2.5V $V_{OUT}$	$I_{OUT} = 1\text{mA}$	-50		50	mV	
		$T_{AMB} = -40$ to $125^{\circ}\text{C}$	-75		75		
	Output Voltage Accuracy $\geq 2.5\text{V } V_{OUT}$	$I_{OUT} = 1\text{mA}$	-1		1	% of $V_{OUT(NOM)}$	
		$T_{AMB} = -40$ to $125^{\circ}\text{C}$	-2		2		
$\Delta V_{OUT}$	Line Regulation <sup>1</sup>	$V_{IN} = (V_{OUT(NOM)} + 0.5\text{V})$ to $4.5\text{V}$ , $V_{OUT} < 3\text{V}$	-0.15		0.15	% / V	
		$V_{IN} = (V_{OUT(NOM)} + 0.5\text{V})$ to $5.5\text{V}$ , $V_{OUT} < 3\text{V}$	-0.3		0.3		
	Load Regulation	$I_{OUT} = 1$ to $150\text{mA}$ , $V_{OUT} < 2.5\text{V}$ , $T_{AMB} = -40$ to $125^{\circ}\text{C}$			0.002	0.008	% / mA
		$I_{OUT} = 1$ to $150\text{mA}$ , $V_{OUT} \geq 2.5\text{V}$ , $T_{AMB} = -40$ to $125^{\circ}\text{C}$ (for WLP)			0.0004	0.002	
		$I_{OUT} = 1$ to $150\text{mA}$ , $T_{AMB} = -40$ to $125^{\circ}\text{C}$ (for SOT23-5), $V_{OUT} \geq 2.5\text{V}$			0.0025	0.005	
Output AC Line Regulation	$V_{IN} = V_{OUT(NOM)} + 1\text{V}$ , $I_{OUT} = 150\text{mA}$ , $t_r = t_f = 30\mu\text{s}$			1		mV <sub>PP</sub>	
$I_Q$	Quiescent Current	On Mode: $V_{EN} = 1.2\text{V}$ , $I_{OUT} = 0\text{mA}$		95		$\mu\text{A}$	
		On Mode: $V_{EN} = 1.2\text{V}$ , $I_{OUT} = 0\text{mA}$ , $T_{AMB} = -40$ to $125^{\circ}\text{C}$			130		
		On Mode: $V_{EN} = 1.2\text{V}$ , $I_{OUT} = 0$ to $150\text{mA}$		160			
		On Mode: $V_{EN} = 1.2\text{V}$ , $I_{OUT} = 0$ to $150\text{mA}$ , $T_{AMB} = -40$ to $125^{\circ}\text{C}$			250 <sup>2</sup>		
		Off Mode: $V_{EN} = 0.4\text{V}$ , $I_{OUT} = 0\text{mA}$		0.003 <sup>2</sup>			
		Off Mode: $V_{EN} = 0.4\text{V}$ , $T_{AMB} = -40$ to $125^{\circ}\text{C}$ , $I_{OUT} = 0\text{mA}$			1		
$V_{DROP}$	Dropout Voltage <sup>3</sup>	$I_{OUT} = 1\text{mA}$		0.3		mV	
		$I_{OUT} = 1\text{mA}$ , $T_{AMB} = -40$ to $125^{\circ}\text{C}$			2 <sup>2</sup>		
		$I_{OUT} = 50\text{mA}$		15			
		$I_{OUT} = 50\text{mA}$ , $T_{AMB} = -40$ to $125^{\circ}\text{C}$			35		
		$I_{OUT} = 100\text{mA}$		30			
		$I_{OUT} = 100\text{mA}$ , $T_{AMB} = -40$ to $125^{\circ}\text{C}$			70		
		$I_{OUT} = 150\text{mA}$		45			
$I_{OUT} = 150\text{mA}$ , $T_{AMB} = -40$ to $125^{\circ}\text{C}$			100				
$I_{SC}$	Short Circuit Current	$R_{LOAD} = 0\Omega$		500		mA	
$SVR$	Supply Voltage Rejection	$V_{IN} = V_{OUT(NOM)} + 1\text{V}$ , $V_{RIPPLE} = 50\text{mV}$ , $I_{OUT} = 50\text{mA}$ , $f = 1\text{kHz}$		60		dB	
		$V_{IN} = V_{OUT(NOM)} + 1\text{V}$ , $V_{RIPPLE} = 50\text{mV}$ , $I_{OUT} = 50\text{mA}$ , $f = 10\text{kHz}$		55			
$I_{OUT(PK)}$	Peak Output Current	$V_{OUT} \geq V_{OUT(NOM)} - 5\%$	300	500		mA	
$V_{EN}$	Enable Input Logic Low	$V_{IN} = 2.5$ to $5.5\text{V}$ , $T_{AMB} = -40$ to $125^{\circ}\text{C}$ <sup>4</sup>			0.4	V	
	Enable Input Logic High		1.2				

Table 3. Electrical Characteristics

Symbol	Parameter	Conditions	Min	Typ	Max	Unit
I <sub>EN</sub>	Enable Input Current	V <sub>EN</sub> = 0.4V, V <sub>IN</sub> = 5.5V		±1 <sup>2</sup>		nA
e <sub>N</sub>	Output Noise Voltage	BW = 10Hz to 100kHz, C <sub>OUT</sub> = 1μF, I <sub>OUT</sub> = 0mA		30		μVRMS
t <sub>ON</sub>	Turn On Time <sup>5</sup>	C <sub>BYPASS</sub> = 10nF		150	250	μs
T <sub>SHDN</sub>	Thermal Shutdown Threshold <sup>4, 6</sup>			160		°C
<b>Recommended Output Capacitor</b>						
C <sub>OUT</sub>	Output Capacitor	Capacitance	1		22 <sup>2</sup>	μF
		ESR	5		5000	mΩ

1. Temperature variations are included within the output voltage accuracy.
2. Guaranteed by design.
3. Dropout voltage is the input-to-output voltage difference at which the output voltage is 100mV below its nominal value (does not apply to input voltages below 2.5V).
4. EN must be driven with a  $t_R = t_F < 10\text{ms}$ .
5. Turn on time is time measured between the enable input just exceeding the V<sub>EN</sub> high value and the output voltage just reaching 95% of its nominal value.
6. Typical thermal protection hysteresis is 20°C.

**Note:** All limits are guaranteed. The parameters with min and max values are guaranteed with production tests or SQC (Statistical Quality Control) methods.

Figure 3. AC Line Regulation Input Voltage Test Signal

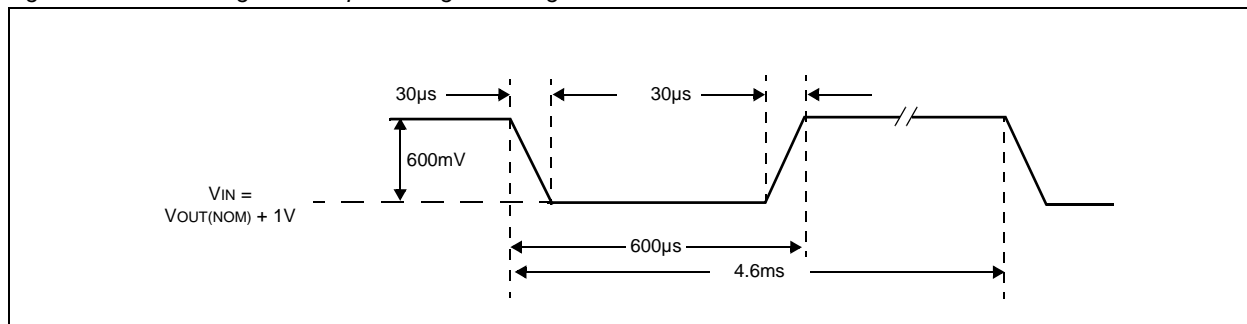
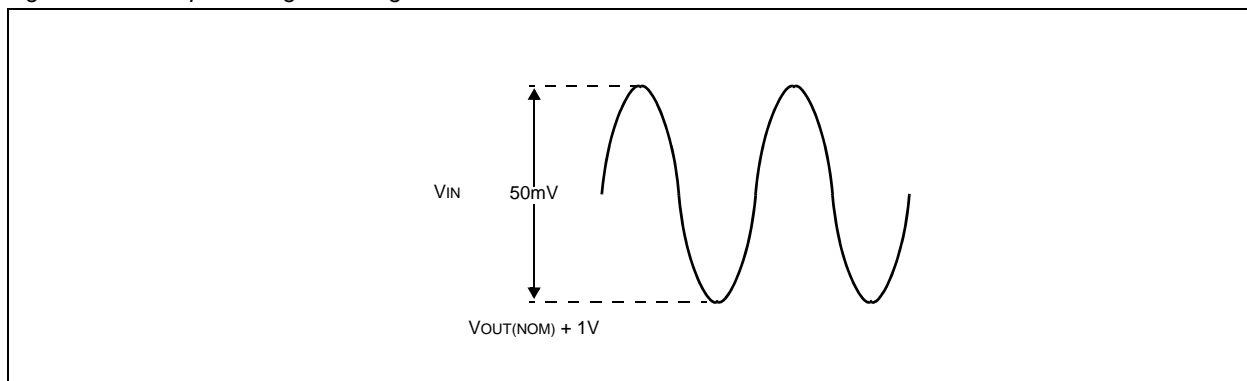

Figure 4. SVR Input Voltage Test Signal



## 7 Typical Operating Characteristics

$T_{AMB} = +25^{\circ}\text{C}$  (unless otherwise specified)

Figure 5. Output Voltage vs. Temperature;  
 $V_{IN} = 3.4\text{V}$ ,  $V_{SHDN} = 1.4\text{V}$ ,  $I_{OUT} = 1\text{mA}$

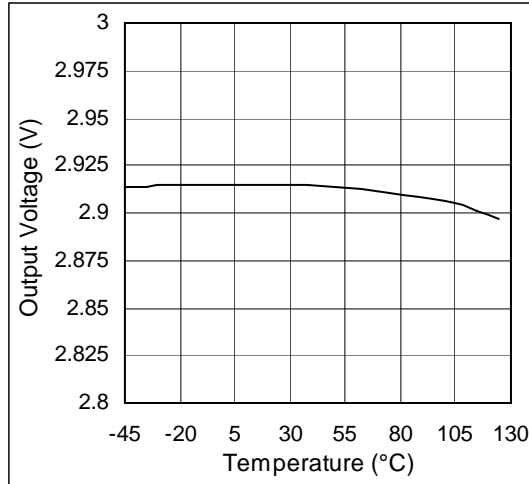

Figure 7. Load Regulation vs. Temperature;  
 $V_{IN} = 3.4\text{V}$ ,  $V_{SHDN} = 1.4\text{V}$ ,  $I_{OUT} = 1$  to  $150\text{mA}$

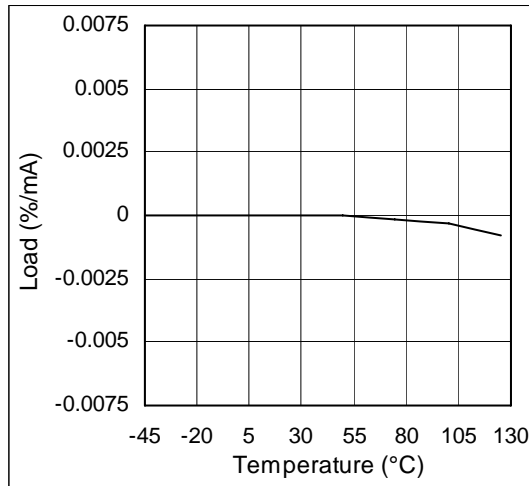

Figure 9. SVR vs. Frequency;  $V_{IN} = 3.9$  to  $3.95\text{V}$ ,  
 $V_{OUT} = 2.9\text{V}$ ,  $I_{OUT} = 50\text{mA}$ ,  $V_{SHDN} = 1.4\text{V}$

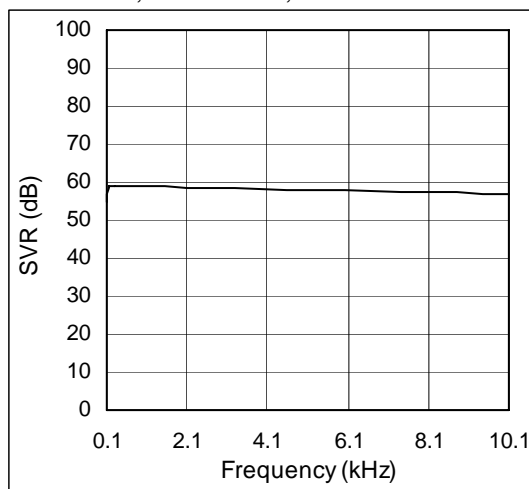

Figure 6. Shutdown Voltage vs. Temperature;  
 $V_{OUT} = 2.9\text{V}$ ,  $I_{OUT} = 10\text{mA}$

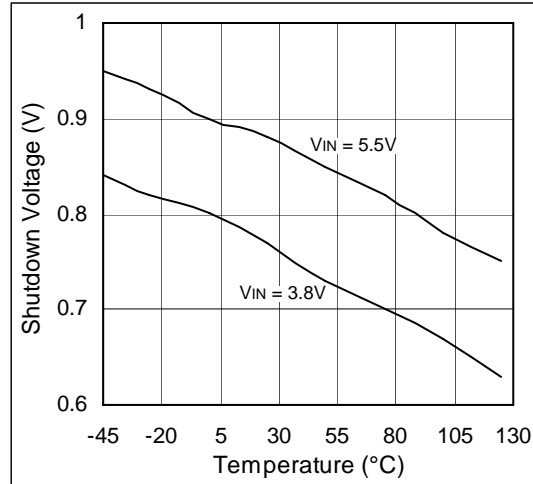

Figure 8. Line Regulation vs. Temperature;  
 $V_{IN} = 3.4$  to  $5.0\text{V}$ ,  $V_{SHDN} = 1.4\text{V}$ ,  $I_{OUT} = 1\text{mA}$

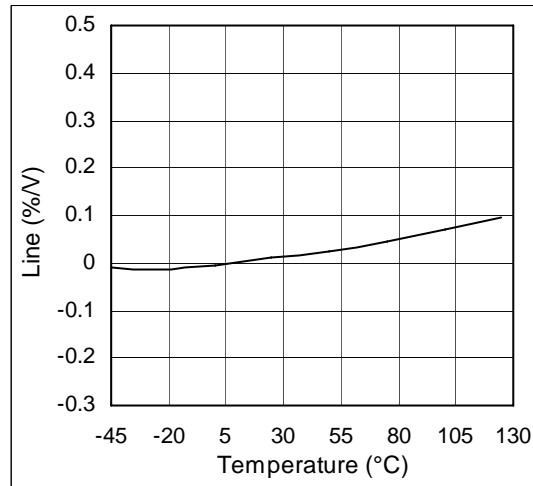

Figure 10. Quiescent Current vs. Temperature;  
 $V_{OUT} = 2.9\text{V}$ ,  $V_{SHDN} = 1.4\text{V}$

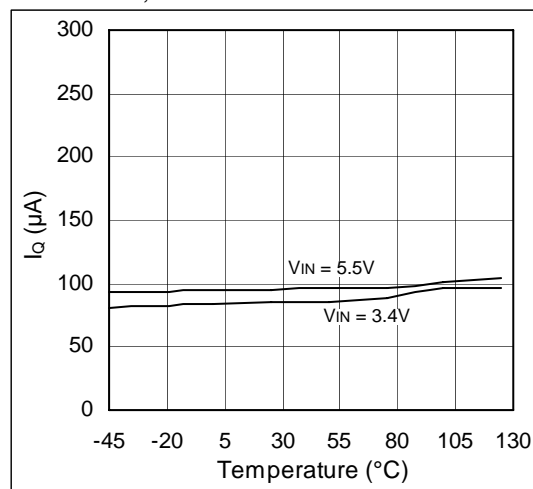

Figure 11. Line Transient Response;  $V_{IN} = 3.8$  to  $4.4V$ ,  $T_J = 25^\circ C$ ,  $I_{OUT} = 150mA$ ,  $C_{IN} = C_{OUT} = 1\mu F$ ,  $V_{OUT} = 2.7V$ ,  $C_{BYPASS} = 10nF$ , Rise Time/Fall Time =  $1\mu s$

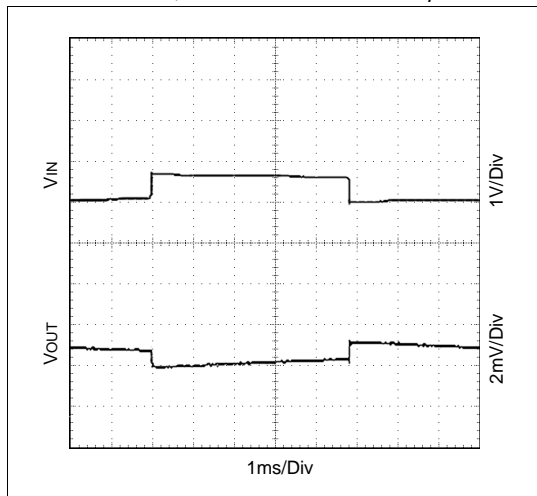
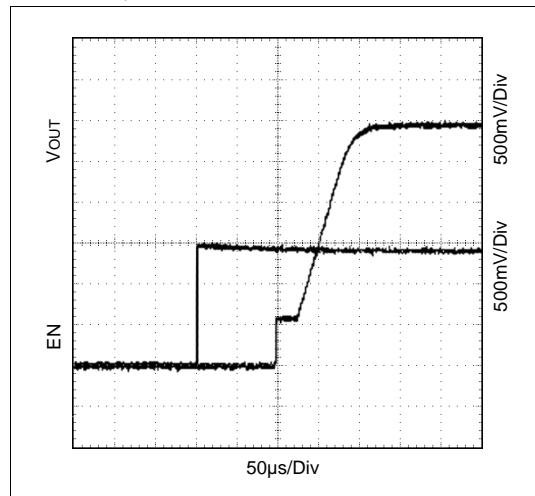
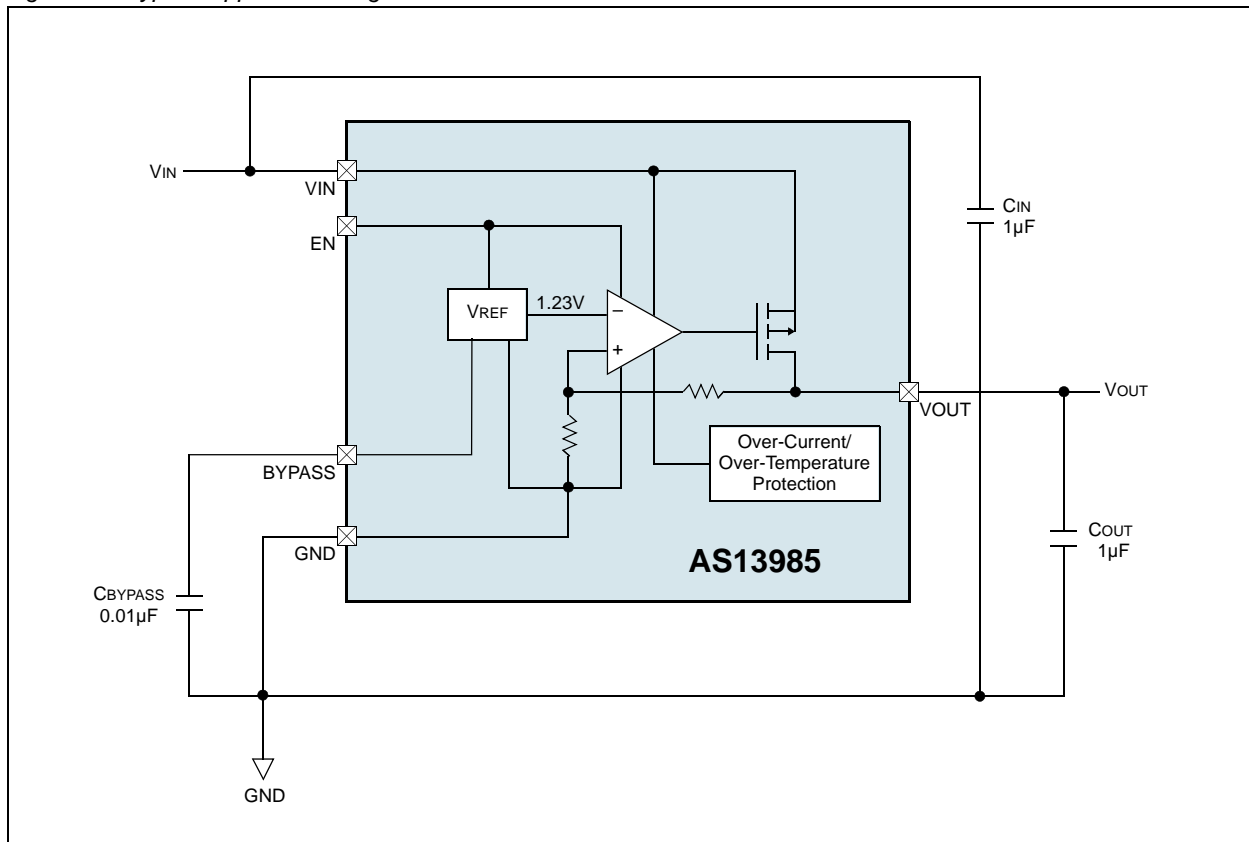

Figure 12. Turn On Time;  $V_{IN} = 3.3V$ ,  $C_{BYPASS} = 10nF$ ,  $C_{IN} = C_{OUT} = 1\mu F$  (Ceramic),  $t_R = 20ns$ ,  $I_{OUT} = 1mA$ ,  $V_{OUT} = 2.8V$



## 8 Typical Application

Figure 13. Typical Application Diagram



## 9 Package Drawings and Markings

The AS13985 is available in a 5-bump WLP package and a 5-pin SOT23 package.

Figure 14. 5-bump WLP Package

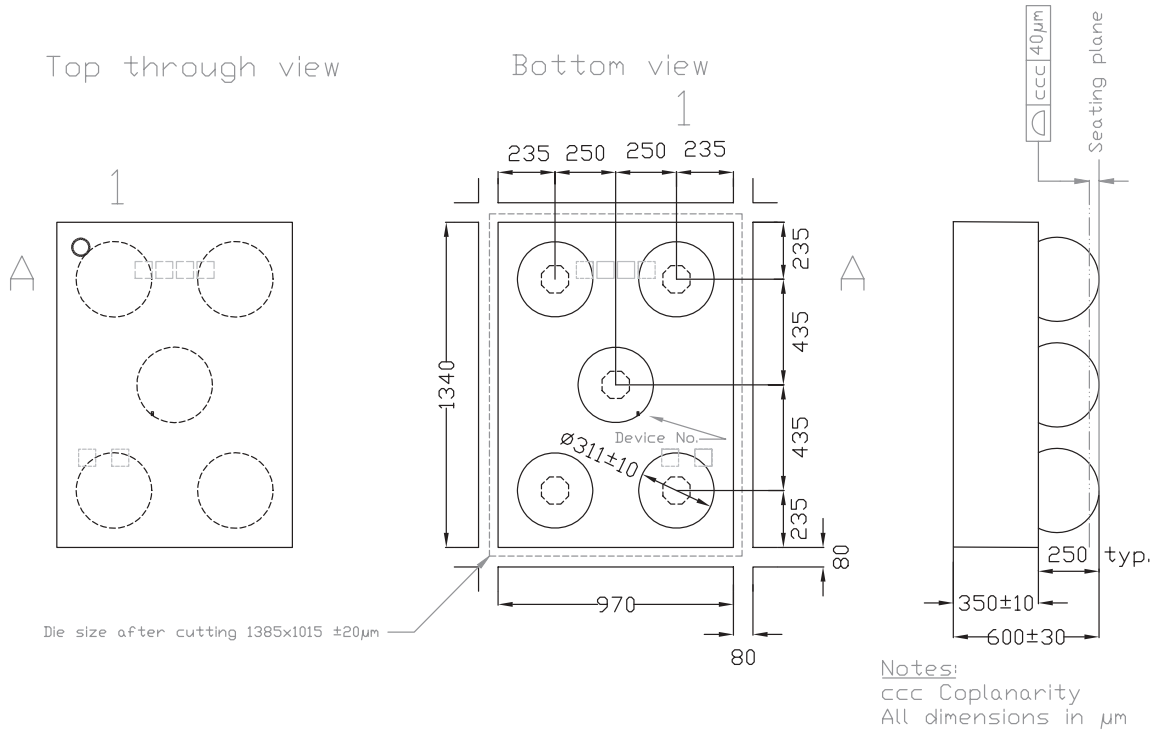
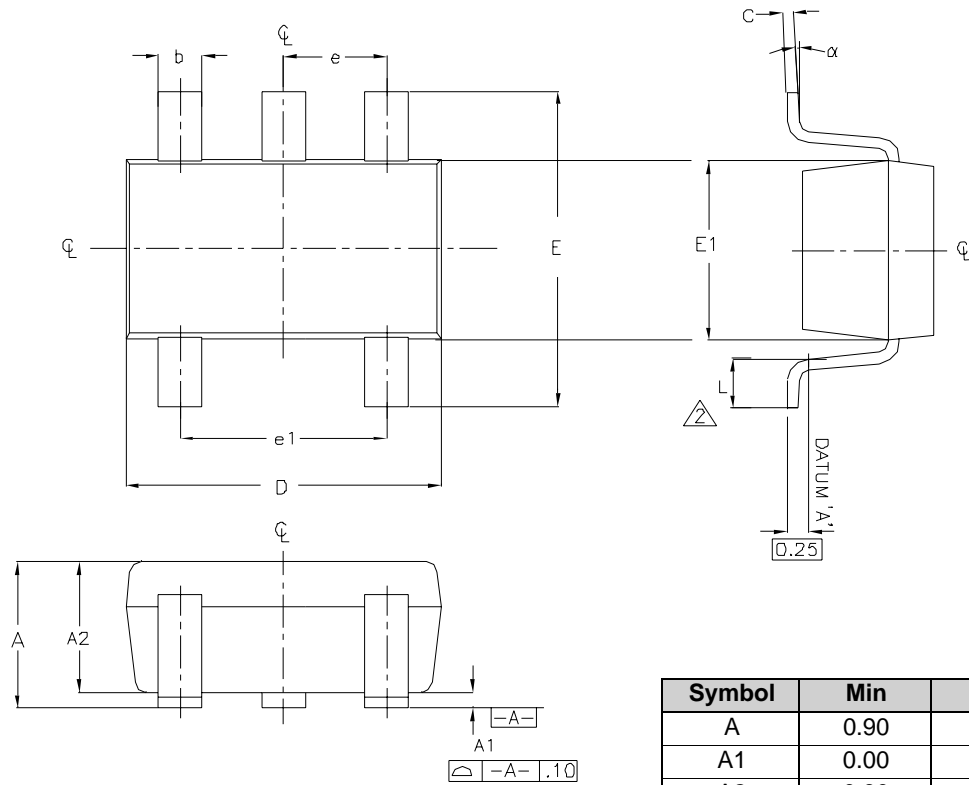

Figure 15. 5-pin SOT23 Package

**Notes:**

1. All dimensions are in millimeters.
2. Foot length is measured at the intercept point between datum A and lead surface.
3. Package outline exclusive of mold flash and metal burr.
4. Package outline inclusive of solder plating.
5. Complies with EIAJ SC74.

Symbol	Min	Max
A	0.90	1.45
A1	0.00	0.15
A2	0.90	1.30
b	0.30	0.50
C	0.09	0.20
D	2.80	3.05
E	2.60	3.00
E1	1.50	1.75
L	0.30	0.55
e	0.95 Ref	
e1	1.90 Ref	
$\alpha$	0°	8°

## 10 Ordering Information

The AS13985 is available as the standard versions listed in Table 4. Other versions are available upon request. For more information and inquiries contact <http://www.austriamicrosystems.com/contact>

Table 4. Ordering Information

Ordering Code	Marking	Description	Delivery Form	Package
AS13985F33-T	ASKK	3.3V LDO, 150mA	Tape and Reel	5-bump WLP
AS13985F30-T	ASKJ	3.0V LDO, 150mA	Tape and Reel	5-bump WLP
AS13985F29-T	ASKI	2.9V LDO, 150mA	Tape and Reel	5-bump WLP
AS13985F28-T	ASLE	2.8V LDO, 150mA	Tape and Reel	5-bump WLP
AS13985F27-T	ASKL	2.7V LDO, 150mA	Tape and Reel	5-bump WLP
AS13985F18-T	ASKM	1.8V LDO, 150mA	Tape and Reel	5-bump WLP
AS13985F12-T	ASKN	1.2V LDO, 150mA	Tape and Reel	5-bump WLP
AS13985H33-T	ASK0	3.3V LDO, 150mA	Tape and Reel	5-pin SOT23
AS13985H30-T	ASK1	3.0V LDO, 150mA	Tape and Reel	5-pin SOT23
AS13985H29-T	ASK2	2.9V LDO, 150mA	Tape and Reel	5-pin SOT23
AS13985H28-T	ASLF	2.8V LDO, 150mA	Tape and Reel	5-pin SOT23
AS13985H27-T	ASK3	2.7V LDO, 150mA	Tape and Reel	5-pin SOT23
AS13985H18-T	ASK4	1.8V LDO, 150mA	Tape and Reel	5-pin SOT23
AS13985H12-T	ASK5	1.2V LDO, 150mA	Tape and Reel	5-pin SOT23

**Note:** All products are RoHS compliant and Pb-free.

Buy our products or get free samples online at ICdirect: <http://www.austriamicrosystems.com/ICdirect>

For further information and requests, please contact us <mailto:sales@austriamicrosystems.com> or find your local distributor at <http://www.austriamicrosystems.com/distributor>

## Copyrights

Copyright © 1997-2009, austriamicrosystems AG, Tobelbaderstrasse 30, 8141 Unterpremstaetten, Austria-Europe. Trademarks Registered ®. All rights reserved. The material herein may not be reproduced, adapted, merged, translated, stored, or used without the prior written consent of the copyright owner.

All products and companies mentioned are trademarks or registered trademarks of their respective companies.

## Disclaimer

Devices sold by austriamicrosystems AG are covered by the warranty and patent indemnification provisions appearing in its Term of Sale. austriamicrosystems AG makes no warranty, express, statutory, implied, or by description regarding the information set forth herein or regarding the freedom of the described devices from patent infringement. austriamicrosystems AG reserves the right to change specifications and prices at any time and without notice. Therefore, prior to designing this product into a system, it is necessary to check with austriamicrosystems AG for current information. This product is intended for use in normal commercial applications. Applications requiring extended temperature range, unusual environmental requirements, or high reliability applications, such as military, medical life-support or life-sustaining equipment are specifically not recommended without additional processing by austriamicrosystems AG for each application. For shipments of less than 100 parts the manufacturing flow might show deviations from the standard production flow, such as test flow or test location.

The information furnished here by austriamicrosystems AG is believed to be correct and accurate. However, austriamicrosystems AG shall not be liable to recipient or any third party for any damages, including but not limited to personal injury, property damage, loss of profits, loss of use, interruption of business or indirect, special, incidental or consequential damages, of any kind, in connection with or arising out of the furnishing, performance or use of the technical data herein. No obligation or liability to recipient or any third party shall arise or flow out of austriamicrosystems AG rendering of technical or other services.



## Contact Information

### Headquarters

austriamicrosystems AG  
Tobelbaderstrasse 30  
A-8141 Unterpremstaetten, Austria

Tel: +43 (0) 3136 500 0  
Fax: +43 (0) 3136 525 01

For Sales Offices, Distributors and Representatives, please visit:

<http://www.austriamicrosystems.com/contact>

## Looking for pricing, stock, or lifecycle information?

Click below to explore more details on WIN SOURCE:

 [View AS13985H18-T on WIN SOURCE](#)

 [ams Information](#)

## Optimize Your Supply Chain with WIN SOURCE Solutions

-  Global Sourcing Solution
-  Obsolete Management
-  Cost Control Management
-  Shortage Management
-  Alternative Solution
-  Excess Inventory Management