



**THE DATASHEET OF
SBC846BLT3G**



BC846ALT1G Series

General Purpose Transistors

NPN Silicon

Features

- Moisture Sensitivity Level: 1
- ESD Rating – Human Body Model: > 4000 V
– Machine Model: > 400 V
- S and NSV Prefix for Automotive and Other Applications Requiring Unique Site and Control Change Requirements; AEC-Q101 Qualified and PPAP Capable
- These Devices are Pb-Free, Halogen Free/BFR Free and are RoHS Compliant

MAXIMUM RATINGS

| Rating | Symbol | Value | Unit |
|--|-----------|-------------------|------|
| Collector-Emitter Voltage BC846 BC847, BC850 BC848, BC849 | V_{CEO} | 65 45 30 | Vdc |
| Collector-Base Voltage BC846 BC847, BC850 BC848, BC849 | V_{CBO} | 80 50 30 | Vdc |
| Emitter-Base Voltage BC846 BC847, BC850 BC848, BC849 | V_{EBO} | 6.0 6.0 5.0 | Vdc |
| Collector Current – Continuous | I_C | 100 | mAdc |

Stresses exceeding those listed in the Maximum Ratings table may damage the device. If any of these limits are exceeded, device functionality should not be assumed, damage may occur and reliability may be affected.

THERMAL CHARACTERISTICS

| Characteristic | Symbol | Max | Unit |
|---|-----------------|----------------|-------------|
| Total Device Dissipation FR-5 Board, (Note 1) $T_A = 25^\circ\text{C}$ Derate above 25°C | P_D | 225 1.8 | mW mW/°C |
| Thermal Resistance, Junction-to-Ambient (Note 1) | $R_{\theta JA}$ | 556 | °C/W |
| Total Device Dissipation Alumina Substrate (Note 2) $T_A = 25^\circ\text{C}$ Derate above 25°C | P_D | 300 2.4 | mW mW/°C |
| Thermal Resistance, Junction-to-Ambient (Note 2) | $R_{\theta JA}$ | 417 | °C/W |
| Junction and Storage Temperature Range | T_J, T_{stg} | -55 to +150 | °C |

1. FR-5 = $1.0 \times 0.75 \times 0.062$ in.
2. Alumina = $0.4 \times 0.3 \times 0.024$ in 99.5% alumina.



ON Semiconductor®

www.onsemi.com

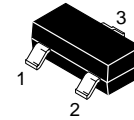
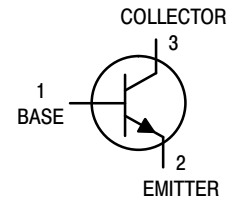

SOT-23
CASE 318
STYLE 6

MARKING DIAGRAM

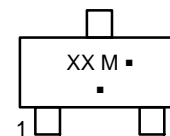

XX = Device Code
M = Date Code*
▪ = Pb-Free Package

(Note: Microdot may be in either location)

*Date Code orientation and/or overbar may vary depending upon manufacturing location.

ORDERING INFORMATION

See detailed ordering and shipping information in the package dimensions section on page 12 of this data sheet.

BC846ALT1G Series

ELECTRICAL CHARACTERISTICS ($T_A = 25^\circ\text{C}$ unless otherwise noted)

| Characteristic | Symbol | Min | Typ | Max | Unit | |
|---|---|---------------|-------------------|-------------------|-------------------|---------------------|
| OFF CHARACTERISTICS | | | | | | |
| Collector–Emitter Breakdown Voltage ($I_C = 10\text{ mA}$) | BC846A, B BC847A, B, C, BC850B, C BC848A, B, C, BC849B, C | $V_{(BR)CEO}$ | 65 45 30 | – – – | – – – | V |
| Collector–Emitter Breakdown Voltage ($I_C = 10\ \mu\text{A}$, $V_{EB} = 0$) | BC846A, B BC847A, B, C BC850B, C BC848A, B, C, BC849B, C | $V_{(BR)CES}$ | 80 50 30 | – – – | – – – | V |
| Collector–Base Breakdown Voltage ($I_C = 10\ \mu\text{A}$) | BC846A, B BC847A, B, C, BC850B, C BC848A, B, C, BC849B, C | $V_{(BR)CBO}$ | 80 50 30 | – – – | – – – | V |
| Emitter–Base Breakdown Voltage ($I_E = 1.0\ \mu\text{A}$) | BC846A, B BC847A, B, C, BC850B, C BC848A, B, C, BC849B, C | $V_{(BR)EBO}$ | 6.0 6.0 5.0 | – – – | – – – | V |
| Collector Cutoff Current ($V_{CB} = 30\text{ V}$) ($V_{CB} = 30\text{ V}$, $T_A = 150^\circ\text{C}$) | | I_{CBO} | – – | – – | 15 5.0 | nA μA |
| ON CHARACTERISTICS | | | | | | |
| DC Current Gain ($I_C = 10\ \mu\text{A}$, $V_{CE} = 5.0\text{ V}$) | BC846A, BC847A, BC848A BC846B, BC847B, BC848B BC847C, BC848C | h_{FE} | – – – | 90 150 270 | – – – | – |
| ($I_C = 2.0\text{ mA}$, $V_{CE} = 5.0\text{ V}$) | BC846A, BC847A, BC848A BC846B, BC847B, BC848B, BC849B, BC850B BC847C, BC848C, BC849C, BC850C | | 110 200 420 | 180 290 520 | 220 450 800 | |
| Collector–Emitter Saturation Voltage ($I_C = 10\text{ mA}$, $I_B = 0.5\text{ mA}$) ($I_C = 100\text{ mA}$, $I_B = 5.0\text{ mA}$) | | $V_{CE(sat)}$ | – – | – – | 0.25 0.6 | V |
| Base–Emitter Saturation Voltage ($I_C = 10\text{ mA}$, $I_B = 0.5\text{ mA}$) ($I_C = 100\text{ mA}$, $I_B = 5.0\text{ mA}$) | | $V_{BE(sat)}$ | – – | 0.7 0.9 | – – | V |
| Base–Emitter Voltage ($I_C = 2.0\text{ mA}$, $V_{CE} = 5.0\text{ V}$) ($I_C = 10\text{ mA}$, $V_{CE} = 5.0\text{ V}$) | | $V_{BE(on)}$ | 580 – | 660 – | 700 770 | mV |
| SMALL–SIGNAL CHARACTERISTICS | | | | | | |
| Current–Gain – Bandwidth Product ($I_C = 10\text{ mA}$, $V_{CE} = 5.0\text{ Vdc}$, $f = 100\text{ MHz}$) | | f_T | 100 | – | – | MHz |
| Output Capacitance ($V_{CB} = 10\text{ V}$, $f = 1.0\text{ MHz}$) | | C_{obo} | – | – | 4.5 | pF |
| Noise Figure ($I_C = 0.2\text{ mA}$, $V_{CE} = 5.0\text{ Vdc}$, $R_S = 2.0\text{ k}\Omega$, $f = 1.0\text{ kHz}$, $BW = 200\text{ Hz}$) | BC846A,B, BC847A,B,C, BC848A,B,C BC849B,C, BC850B,C | NF | – – | – – | 10 4.0 | dB |

Product parametric performance is indicated in the Electrical Characteristics for the listed test conditions, unless otherwise noted. Product performance may not be indicated by the Electrical Characteristics if operated under different conditions.

BC846ALT1G Series

BC846A, BC847A, BC848A, SBC846A

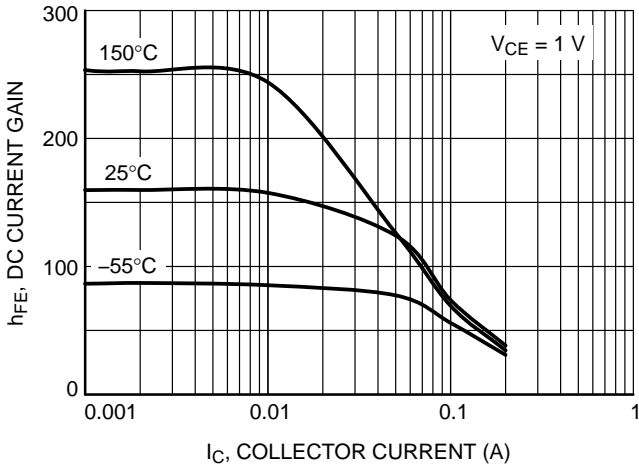

Figure 1. DC Current Gain vs. Collector Current

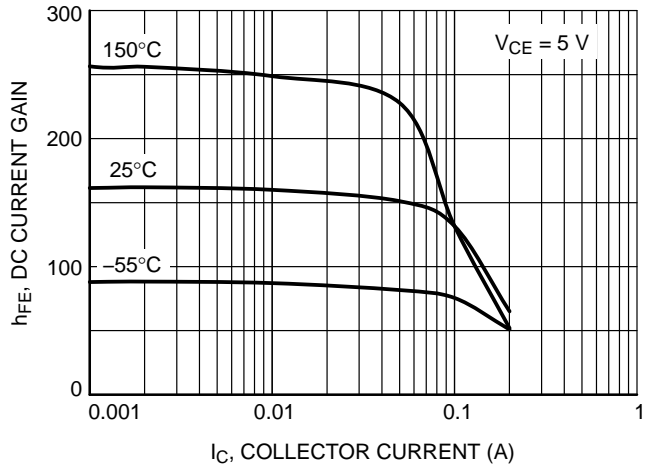

Figure 2. DC Current Gain vs. Collector Current

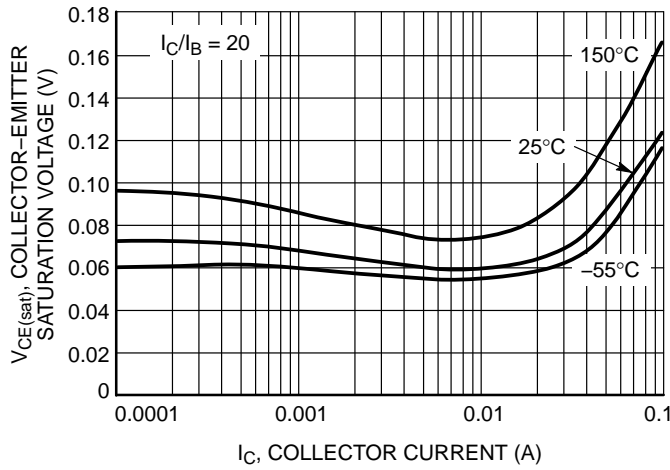

Figure 3. Collector Emitter Saturation Voltage vs. Collector Current

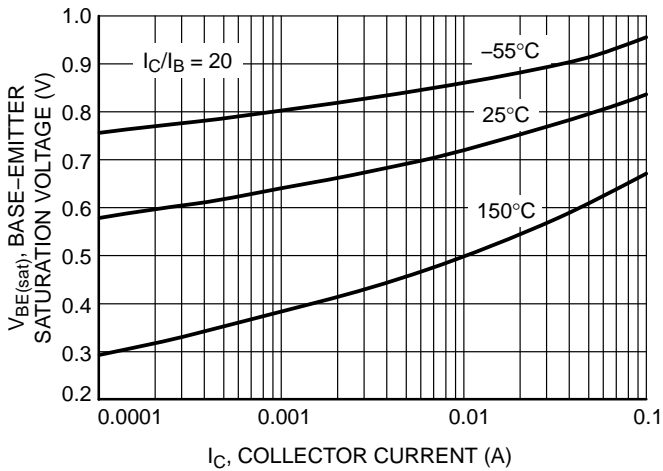

Figure 4. Base Emitter Saturation Voltage vs. Collector Current

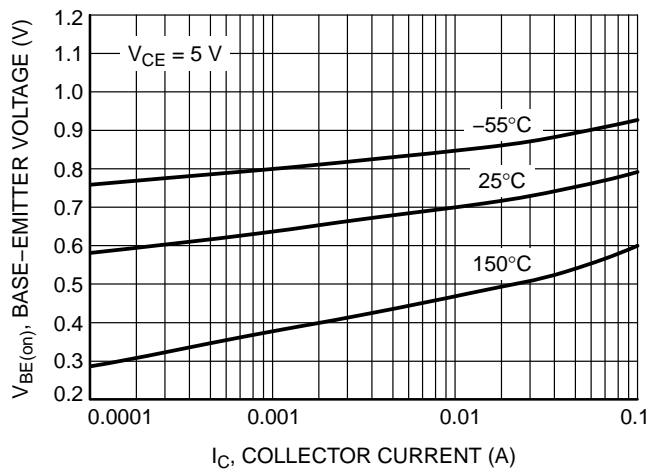

Figure 5. Base Emitter Voltage vs. Collector Current

BC846ALT1G Series

BC846A, BC847A, BC848A, SBC846A

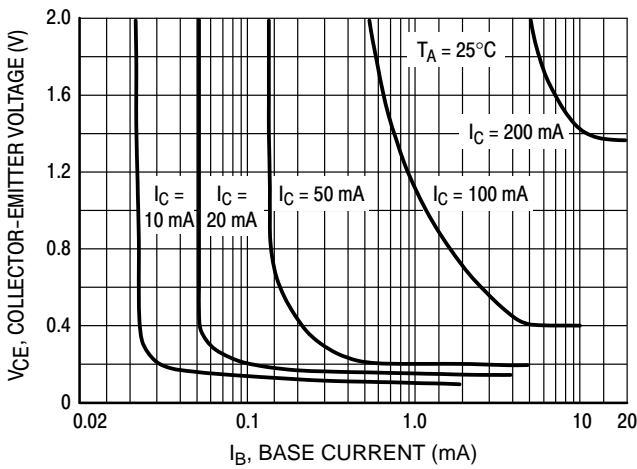

Figure 6. Collector Saturation Region

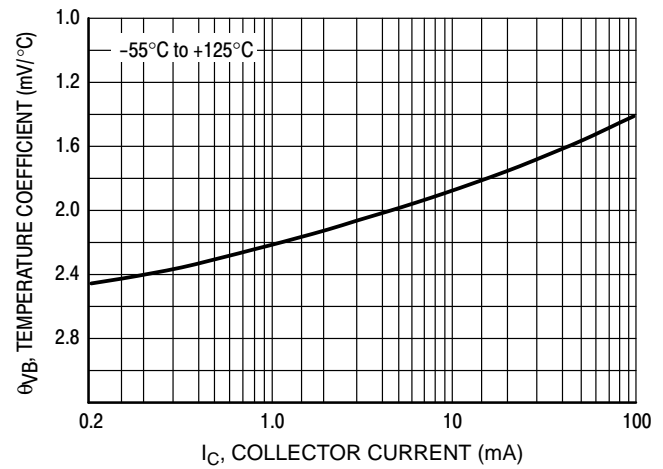

Figure 7. Base-Emitter Temperature Coefficient

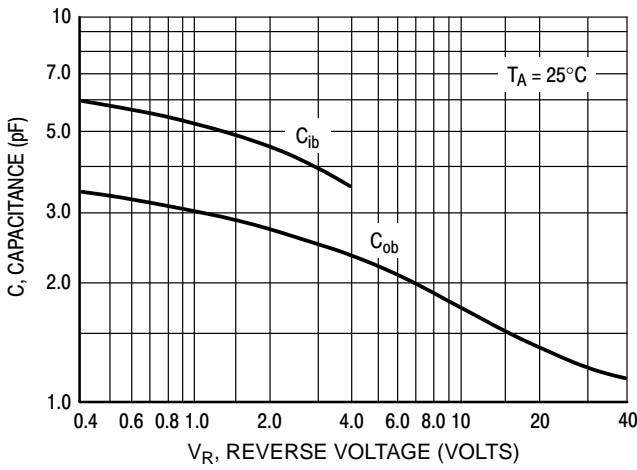

Figure 8. Capacitances

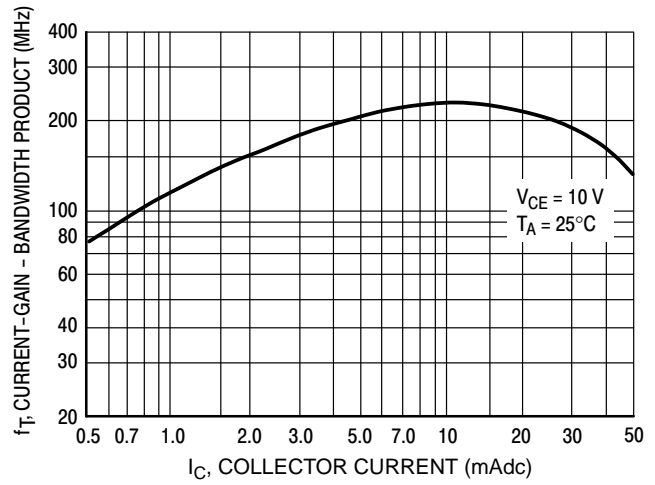

Figure 9. Current-Gain - Bandwidth Product

BC846ALT1G Series

BC846B, SBC846B

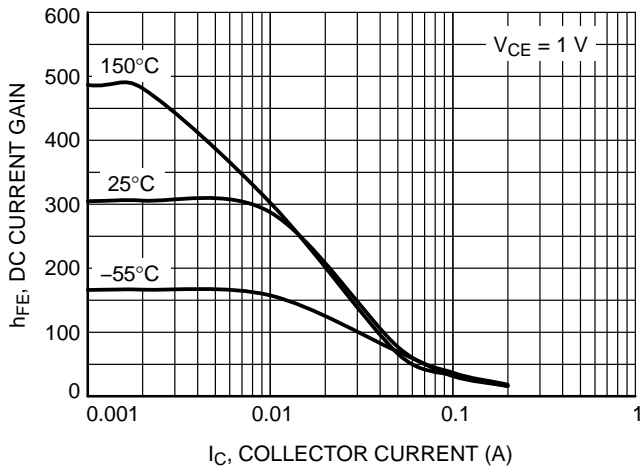

Figure 10. DC Current Gain vs. Collector Current

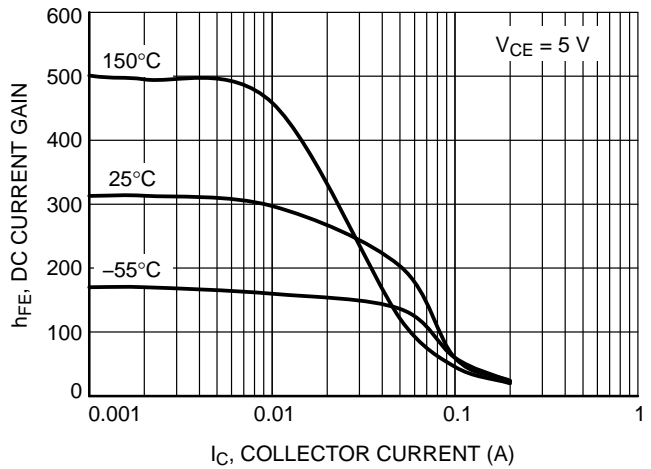

Figure 11. DC Current Gain vs. Collector Current

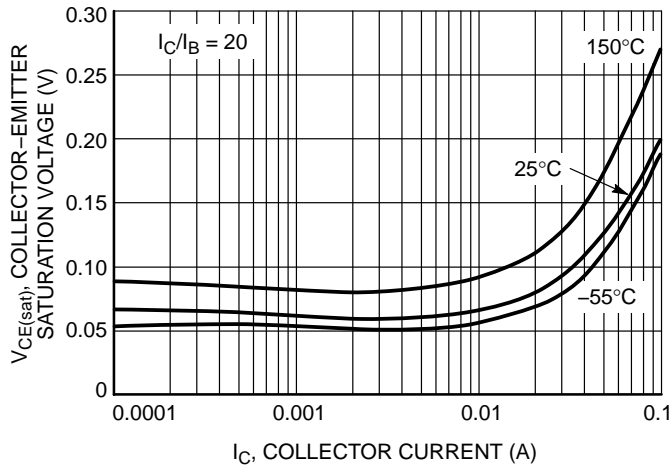

Figure 12. Collector Emitter Saturation Voltage vs. Collector Current

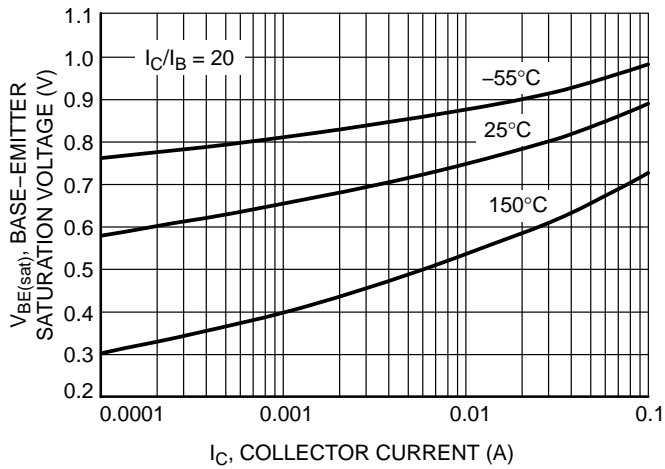

Figure 13. Base Emitter Saturation Voltage vs. Collector Current

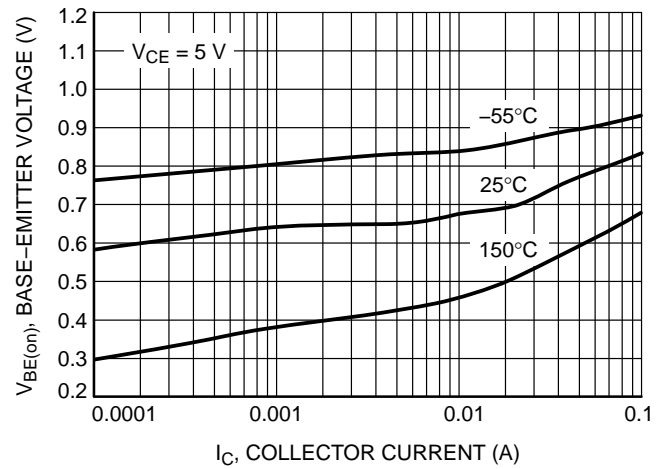

Figure 14. Base Emitter Voltage vs. Collector Current

BC846ALT1G Series

BC846B, SBC846B

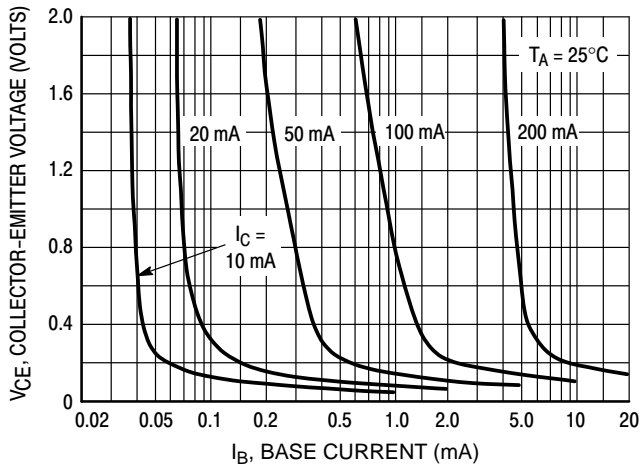

Figure 15. Collector Saturation Region

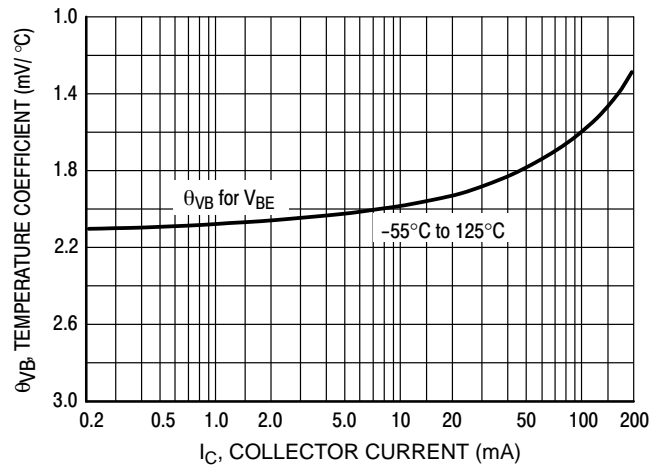

Figure 16. Base-Emitter Temperature Coefficient

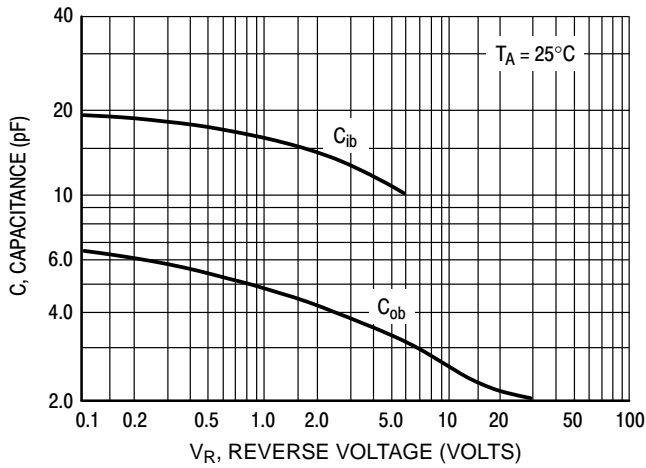

Figure 17. Capacitance

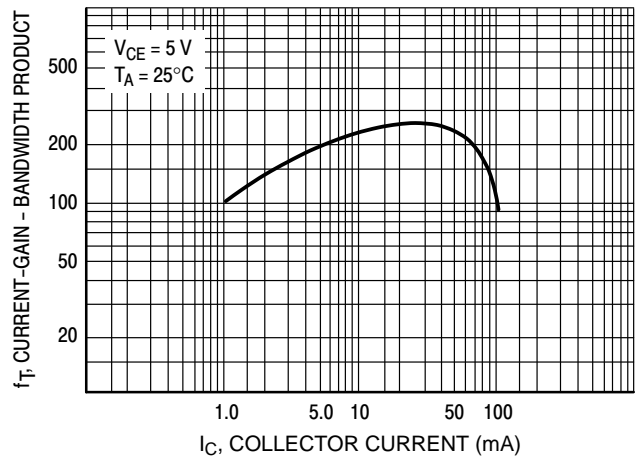

Figure 18. Current-Gain - Bandwidth Product

BC846ALT1G Series

BC847B, BC848B, BC849B, BC850B, SBC847B, SBC848B

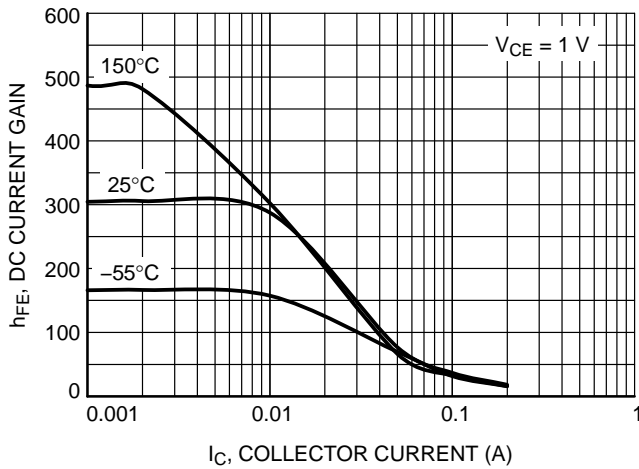

Figure 19. DC Current Gain vs. Collector Current

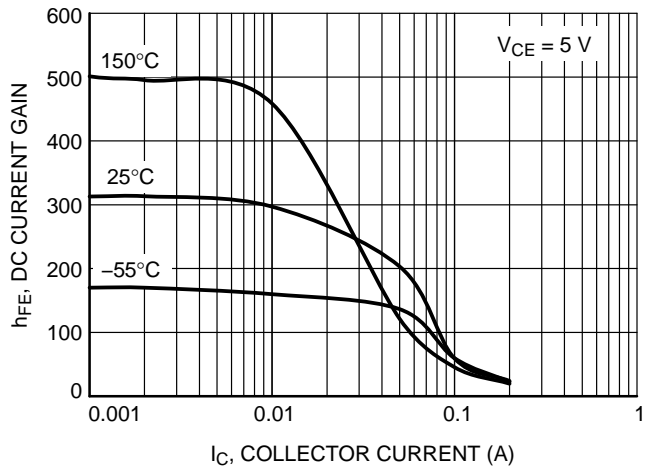

Figure 20. DC Current Gain vs. Collector Current

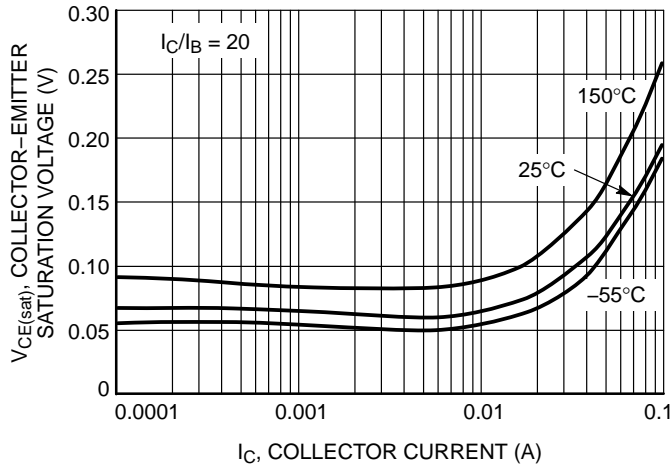

Figure 21. Collector-Emitter Saturation Voltage vs. Collector Current

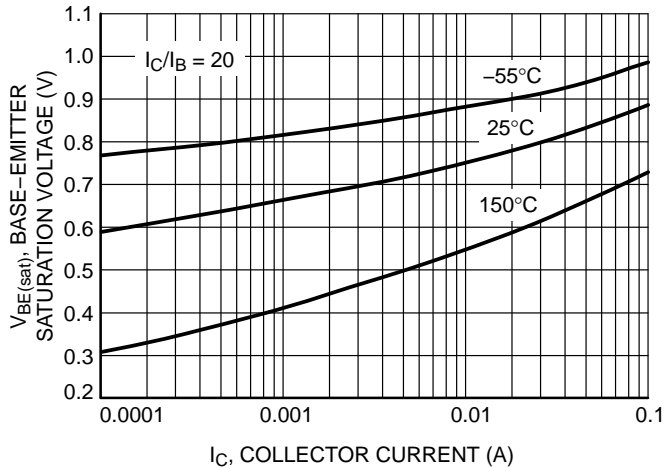

Figure 22. Base-Emitter Saturation Voltage vs. Collector Current

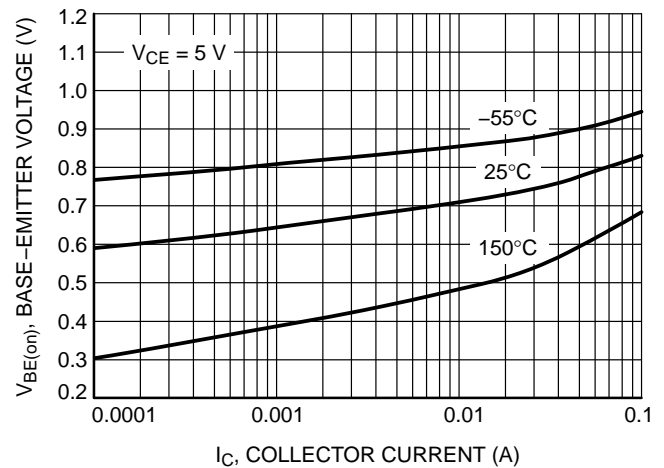

Figure 23. Base-Emitter Voltage vs. Collector Current

BC846ALT1G Series

BC847B, BC848B, BC849B, BC850B, SBC846B, SBC847B, SBC848B

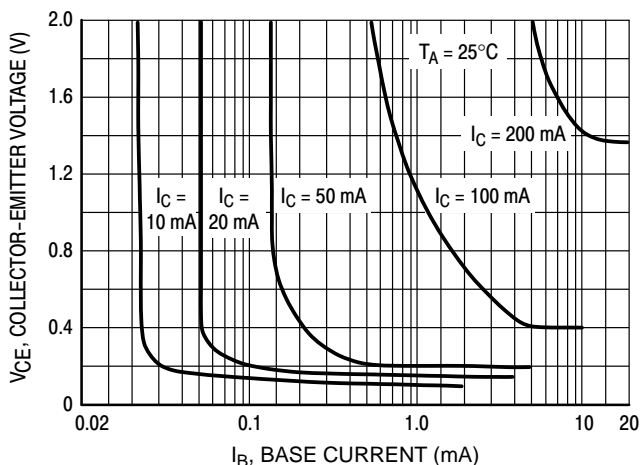

Figure 24. Collector Saturation Region

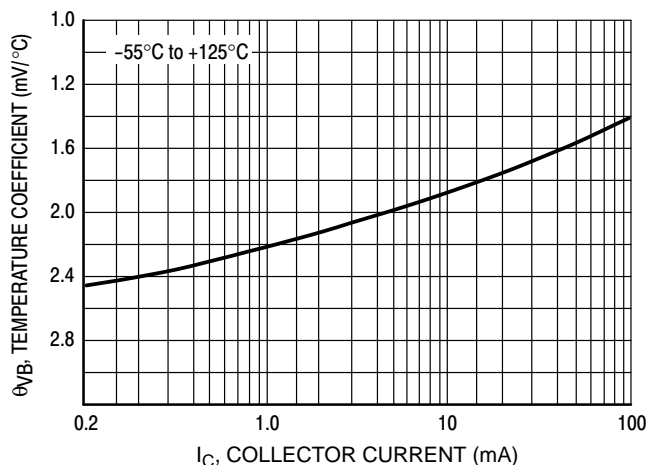

Figure 25. Base-Emitter Temperature Coefficient

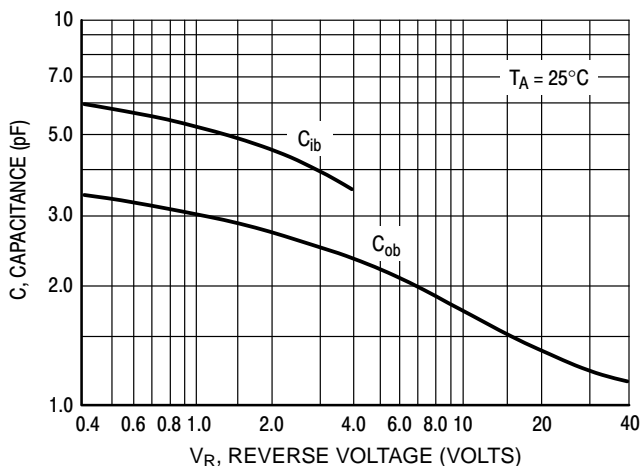

Figure 26. Capacitances

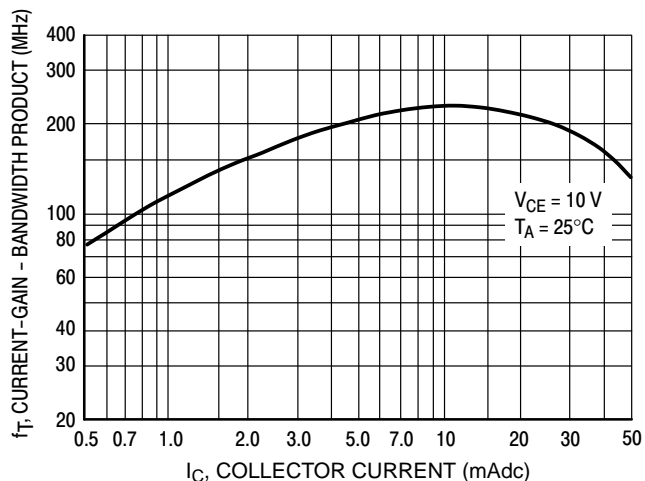

Figure 27. Current-Gain - Bandwidth Product

BC846ALT1G Series

BC847C, BC848C, BC849C, BC850C, SBC847C

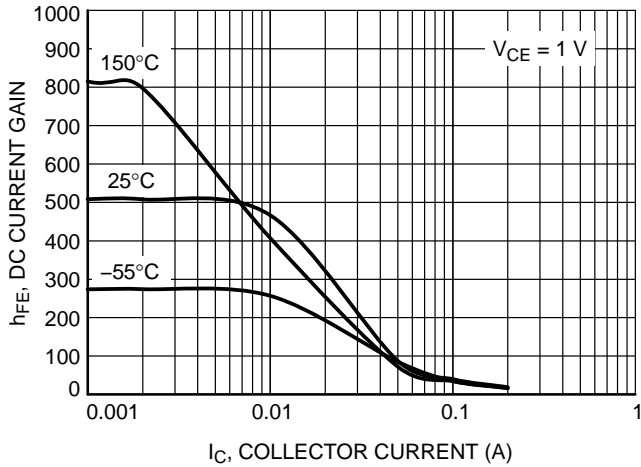

Figure 28. DC Current Gain vs. Collector Current

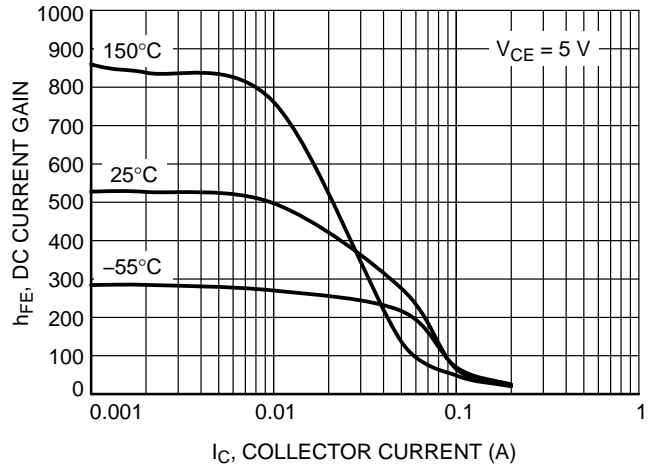

Figure 29. DC Current Gain vs. Collector Current

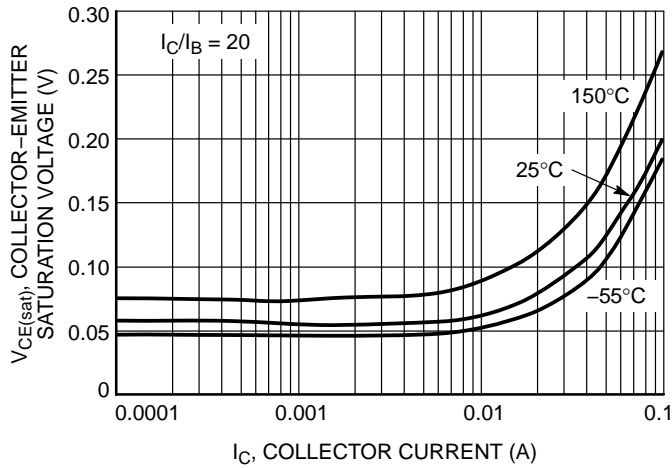

Figure 30. Collector Emitter Saturation Voltage vs. Collector Current

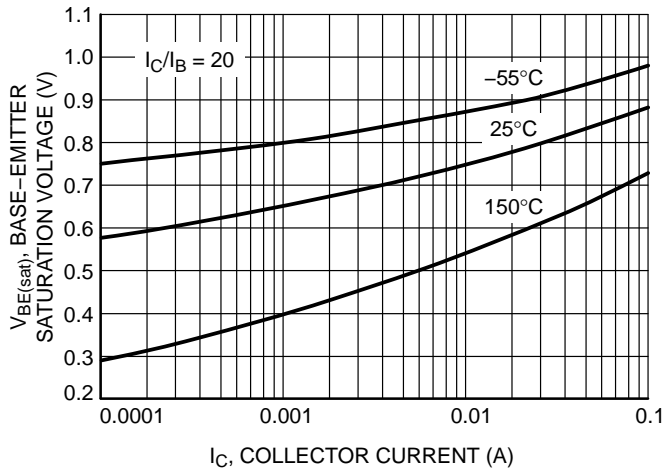

Figure 31. Base Emitter Saturation Voltage vs. Collector Current

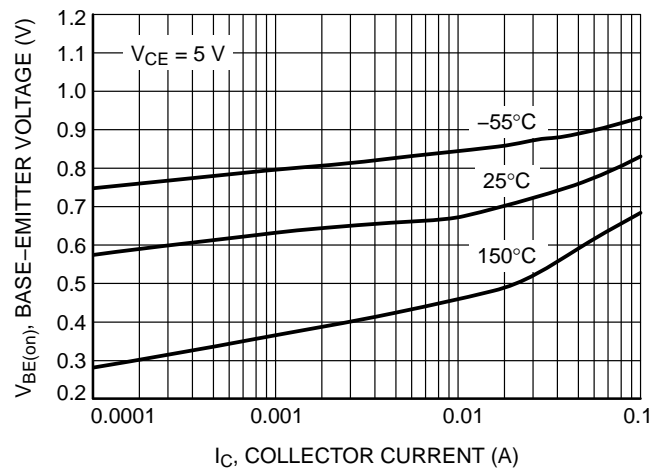

Figure 32. Base Emitter Voltage vs. Collector Current

BC846ALT1G Series

BC847C, BC848C, BC849C, BC850C, SBC847C

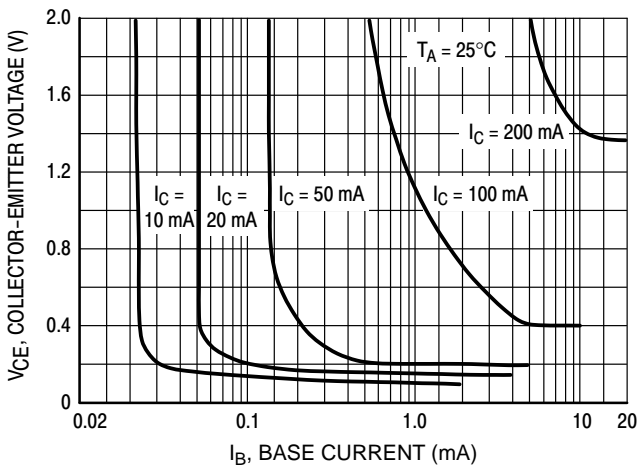

Figure 33. Collector Saturation Region

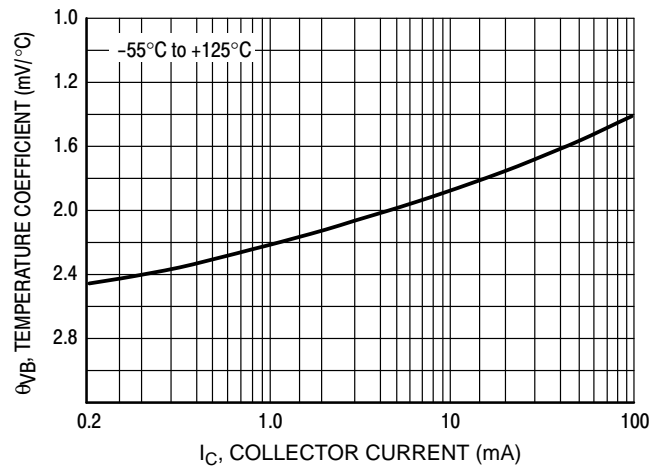

Figure 34. Base-Emitter Temperature Coefficient

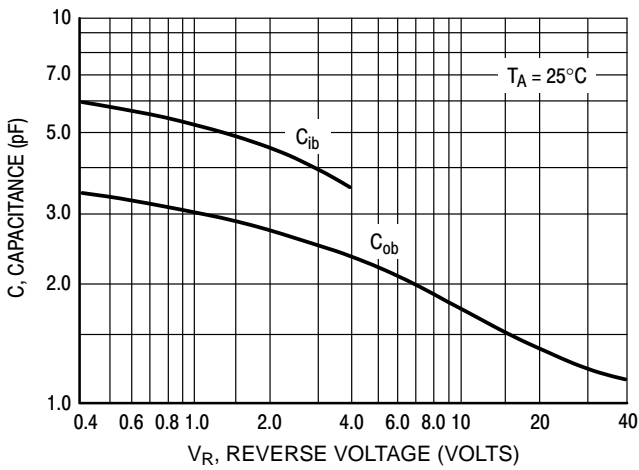

Figure 35. Capacitances

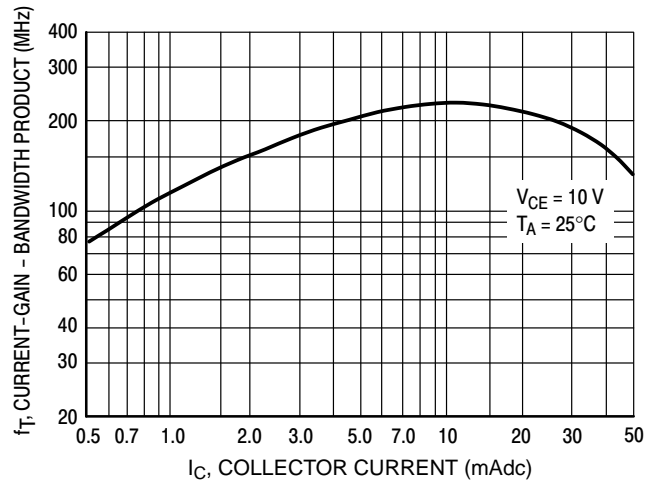

Figure 36. Current-Gain - Bandwidth Product

BC846ALT1G Series

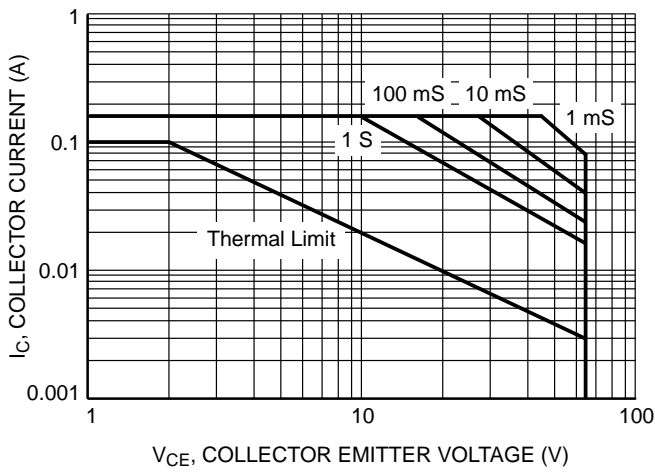

Figure 37. Safe Operating Area for BC846A, BC846B

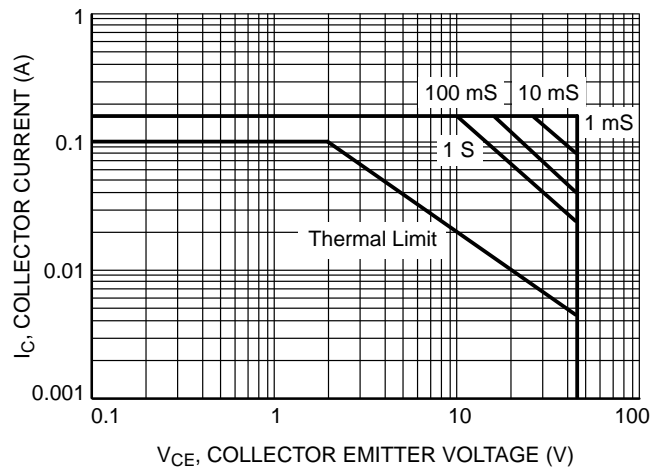

Figure 38. Safe Operating Area for BC847A, BC847B, BC847C, BC850B, BC850C

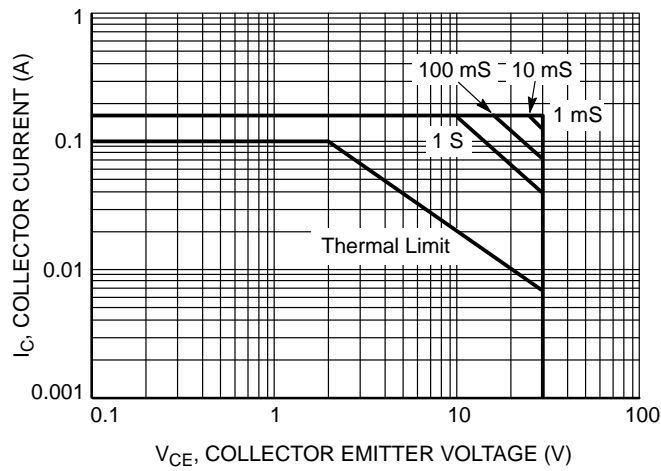

Figure 39. Safe Operating Area for BC848A, BC848B, BC848C, BC849B, BC849C

BC846ALT1G Series

ORDERING INFORMATION

| Device | Marking | Package | Shipping† | |
|----------------|---------|---------------------|----------------------|--|
| BC846ALT1G | 1A | SOT-23 (Pb-Free) | 3,000 / Tape & Reel | |
| SBC846ALT1G* | | | | |
| BC846ALT3G | | | 10,000 / Tape & Reel | |
| BC846BLT1G | 1B | | 3,000 / Tape & Reel | |
| SBC846BLT1G* | | | | |
| BC846BLT3G | | | 10,000 / Tape & Reel | |
| SBC846BLT3G* | | | | |
| BC847ALT1G | 1E | | 3,000 / Tape & Reel | |
| BC847ALT3G | | | 10,000 / Tape & Reel | |
| BC847BLT1G | 1F | | 3,000 / Tape & Reel | |
| SBC847BLT1G* | | | | |
| BC847BLT3G | | | 10,000 / Tape & Reel | |
| NSVBC847BLT3G* | | | | |
| BC847CLT1G | 1G | | 3,000 / Tape & Reel | |
| SBC847CLT1G* | | | | |
| BC847CLT3G | | | 10,000 / Tape & Reel | |
| BC848ALT1G | 1J | | 3,000 / Tape & Reel | |
| BC848BLT1G | 1K | | 3,000 / Tape & Reel | |
| SBC848BLT1G* | | | | |
| BC848BLT3G | | | 10,000 / Tape & Reel | |
| BC848CLT1G | 1L | | 3,000 / Tape & Reel | |
| NSVBC848CLT1G* | | | | |
| BC848CLT3G | | | 10,000 / Tape & Reel | |
| BC849BLT1G | 2B | | 3,000 / Tape & Reel | |
| NSVBC849BLT1G* | | | | |
| BC849BLT3G | | | 10,000 / Tape & Reel | |
| BC849CLT1G | 2C | | 3,000 / Tape & Reel | |
| BC849CLT3G | | | 10,000 / Tape & Reel | |
| BC850BLT1G | 2F | | 3,000 / Tape & Reel | |
| NSVBC850BLT1G* | | | | |
| BC850CLT1G | 2G | | | |
| NSVBC850CLT1G* | | | | |

†For information on tape and reel specifications, including part orientation and tape sizes, please refer to our Tape and Reel Packaging Specifications Brochure, BRD8011/D.

*S and NSV Prefix for Automotive and Other Applications Requiring Unique Site and Control Change Requirements; AEC-Q101 Qualified and PPAP Capable.

BC846ALT1G Series

PACKAGE DIMENSIONS

SOT-23 (TO-236)
CASE 318-08
ISSUE AR

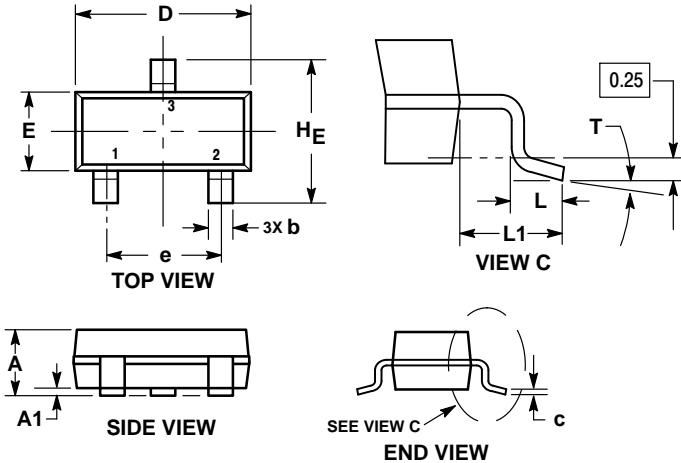

NOTES:

1. DIMENSIONING AND TOLERANCING PER ASME Y14.5M, 1994.
2. CONTROLLING DIMENSION: MILLIMETERS.
3. MAXIMUM LEAD THICKNESS INCLUDES LEAD FINISH. MINIMUM LEAD THICKNESS IS THE MINIMUM THICKNESS OF THE BASE MATERIAL.
4. DIMENSIONS D AND E DO NOT INCLUDE MOLD FLASH, PROTRUSIONS, OR GATE BURRS.

| DIM | MILLIMETERS | | | INCHES | | |
|-----|-------------|------|------|--------|-------|-------|
| | MIN | NOM | MAX | MIN | NOM | MAX |
| A | 0.89 | 1.00 | 1.11 | 0.035 | 0.039 | 0.044 |
| A1 | 0.01 | 0.06 | 0.10 | 0.000 | 0.002 | 0.004 |
| b | 0.37 | 0.44 | 0.50 | 0.015 | 0.017 | 0.020 |
| c | 0.08 | 0.14 | 0.20 | 0.003 | 0.006 | 0.008 |
| D | 2.80 | 2.90 | 3.04 | 0.110 | 0.114 | 0.120 |
| E | 1.20 | 1.30 | 1.40 | 0.047 | 0.051 | 0.055 |
| e | 1.78 | 1.90 | 2.04 | 0.070 | 0.075 | 0.080 |
| L | 0.30 | 0.43 | 0.55 | 0.012 | 0.017 | 0.022 |
| L1 | 0.35 | 0.54 | 0.69 | 0.014 | 0.021 | 0.027 |
| HE | 2.10 | 2.40 | 2.64 | 0.083 | 0.094 | 0.104 |
| T | 0° | — | 10° | 0° | — | 10° |

STYLE 6:
PIN 1. BASE
2. EMITTER
3. COLLECTOR

RECOMMENDED SOLDERING FOOTPRINT*

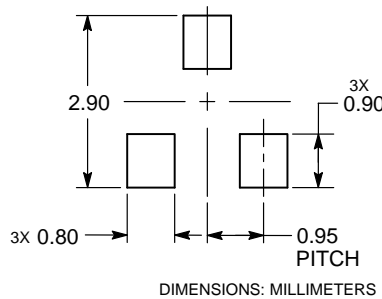

*For additional information on our Pb-Free strategy and soldering details, please download the ON Semiconductor Soldering and Mounting Techniques Reference Manual, SOLDERRM/D.

ON Semiconductor and are trademarks of Semiconductor Components Industries, LLC dba ON Semiconductor or its subsidiaries in the United States and/or other countries. ON Semiconductor owns the rights to a number of patents, trademarks, copyrights, trade secrets, and other intellectual property. A listing of ON Semiconductor's product/patent coverage may be accessed at www.onsemi.com/site/pdf/Patent-Marking.pdf. ON Semiconductor reserves the right to make changes without further notice to any products herein. ON Semiconductor makes no warranty, representation or guarantee regarding the suitability of its products for any particular purpose, nor does ON Semiconductor assume any liability arising out of the application or use of any product or circuit, and specifically disclaims any and all liability, including without limitation special, consequential or incidental damages. Buyer is responsible for its products and applications using ON Semiconductor products, including compliance with all laws, regulations and safety requirements or standards, regardless of any support or applications information provided by ON Semiconductor. "Typical" parameters which may be provided in ON Semiconductor data sheets and/or specifications can and do vary in different applications and actual performance may vary over time. All operating parameters, including "Typicals" must be validated for each customer application by customer's technical experts. ON Semiconductor does not convey any license under its patent rights nor the rights of others. ON Semiconductor products are not designed, intended, or authorized for use as a critical component in life support systems or any FDA Class 3 medical devices or medical devices with a same or similar classification in a foreign jurisdiction or any devices intended for implantation in the human body. Should Buyer purchase or use ON Semiconductor products for any such unintended or unauthorized application, Buyer shall indemnify and hold ON Semiconductor and its officers, employees, subsidiaries, affiliates, and distributors harmless against all claims, costs, damages, and expenses, and reasonable attorney fees arising out of, directly or indirectly, any claim of personal injury or death associated with such unintended or unauthorized use, even if such claim alleges that ON Semiconductor was negligent regarding the design or manufacture of the part. ON Semiconductor is an Equal Opportunity/Affirmative Action Employer. This literature is subject to all applicable copyright laws and is not for resale in any manner.

PUBLICATION ORDERING INFORMATION

LITERATURE FULFILLMENT:
Literature Distribution Center for ON Semiconductor
19521 E. 32nd Pkwy, Aurora, Colorado 80011 USA
Phone: 303-675-2175 or 800-344-3860 Toll Free USA/Canada
Fax: 303-675-2176 or 800-344-3867 Toll Free USA/Canada
Email: orderlit@onsemi.com

N. American Technical Support: 800-282-9855 Toll Free USA/Canada
Europe, Middle East and Africa Technical Support:
Phone: 421 33 790 2910
Japan Customer Focus Center
Phone: 81-3-5817-1050

ON Semiconductor Website: www.onsemi.com
Order Literature: <http://www.onsemi.com/orderlit>

For additional information, please contact your local Sales Representative

Looking for pricing, stock, or lifecycle information?

Click below to explore more details on WIN SOURCE:

 [View SBC846BLT3G](#) on WIN SOURCE

 [ON Semiconductor](#) Information

Optimize Your Supply Chain with WIN SOURCE Solutions

-  Global Sourcing Solution
-  Obsolete Management
-  Cost Control Management
-  Shortage Management
-  Alternative Solution
-  Excess Inventory Management