



THE DATASHEET OF L4931CD25



Very low drop voltage regulators with inhibit

Datasheet - production data

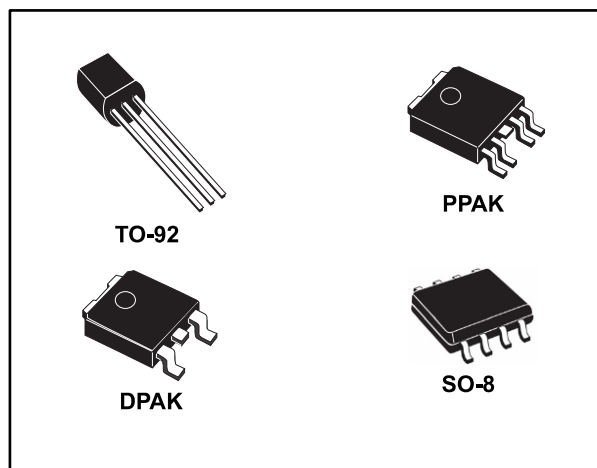

Description

The L4931 is a very low drop regulator available in SO-8, DPAK, PPAK and TO-92 packages and in a wide range of output voltages.

The very low drop voltage (0.4 V) and the very low quiescent current make it particularly suitable for low noise, low power applications and especially in battery-powered systems.

A TTL compatible shutdown logic control function is available in PPAK and SO-8 packages. This means that when the device is used as a local regulator, a part of the board can be put in standby mode, decreasing the total power consumption. It requires only a 2.2 μF capacitor for stability allowing space and cost saving.

The L4931 is available as automotive-grade in SO-8 package only. This device is qualified according to the specification AEC-Q100 of the automotive market, in the temperature range from 40 °C to 125 °C, and the statistical tests: PAT, SYL, SBL are performed.

Features

- Very low dropout voltage (0.4 V)
- Very low quiescent current
- Typ. 50 μA in OFF mode, 600 μA in ON mode
- Output current up to 250 mA
- Logic controlled electronic shutdown
- Output voltages: 3.3; 3.5; 5; 12 V
- Automotive-grade product: 3.3 V V_{OUT} in SO-8 package only
- Internal current and thermal limit
- Only 2.2 μF for stability
- Available in $\pm 1\%$ (AB) or 2% (C) selection at 25 °C
- Supply voltage rejection: 70 dB typ. for 5 V version
- Temperature range: from -40 to 125 °C

Contents

1	Diagram	3
2	Pin configuration	4
3	Maximum ratings	5
4	Application circuit	6
5	Electrical characteristics	7
6	Typical application	16
7	Package information	17
	7.1 TO-92 package information.....	17
	7.2 TO-92 Ammopak packing information.....	18
	7.3 PPAK package information.....	20
	7.4 DPAK package information.....	22
	7.5 PPAK and DPAK paking information.....	25
	7.6 SO-8 package information.....	27
	7.7 SO-8 packing information.....	29
8	Ordering information	30
9	Revision history	31

1 Diagram

Figure 1: Schematic diagram



2 Pin configuration

Figure 2: Pin connections (top view)

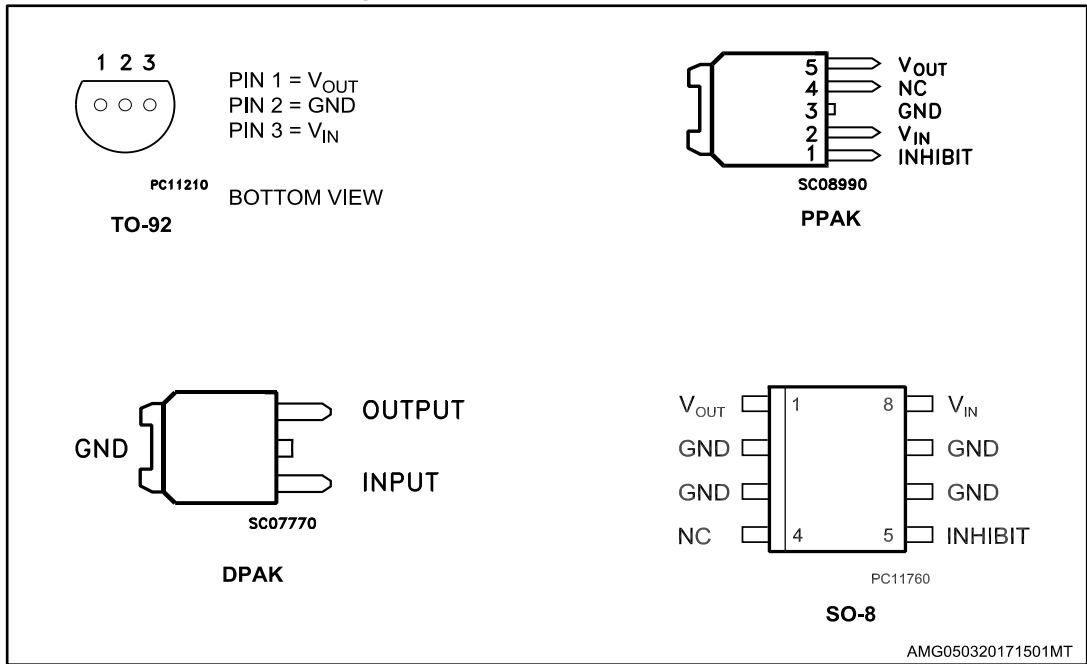

3 Maximum ratings

Table 1: Absolute maximum ratings

Symbol	Parameter	Value	Unit
V_I	DC Input voltage	20	V
I_O	Output current	Internally limited	mA
P_D	Power dissipation	Internally limited	mW
T_{STG}	Storage temperature range	-40 to 150	°C
T_{OP}	Operating junction temperature range	-40 to 125	°C



Absolute maximum ratings are those values beyond which damage to the device may occur. Functional operation under these condition is not implied.

Table 2: Thermal data

Symbol	Parameter	TO-92	DPAK	SO-8	Unit
R_{thJC}	Thermal resistance junction-case		8	20	°C/W
R_{thJA}	Thermal resistance junction-ambient	200	100	55	°C/W

4 Application circuit

Figure 3: Test circuit



5 Electrical characteristics

(Refer to the test circuits, $T_A = 25\text{ °C}$, $C_I = 0.1\text{ }\mu\text{F}$, $C_O = 2.2\text{ }\mu\text{F}$ unless otherwise specified).

Table 3: L4931ABxx33 electrical characteristics

Symbol	Parameter	Test conditions		Min.	Typ.	Max.	Unit
V_O	Output voltage	$I_O = 5\text{ mA}$, $V_I = 5.3\text{ V}$		3.267	3.3	3.333	V
		$I_O = 5\text{ mA}$, $V_I = 5.3\text{ V}$, $T_A = -25\text{ to }85\text{ °C}$		3.234		3.366	
V_I	Operating input voltage	$I_O = 250\text{ mA}$				20	V
I_{out}	Output current limit				300		mA
ΔV_O	Line regulation	$V_I = 4\text{ to }20\text{ V}$, $I_O = 0.5\text{ mA}$			3	15	mV
ΔV_O	Load regulation ⁽¹⁾	$V_I = 4.2\text{ V}$, $I_O = 0.5\text{ to }250\text{ mA}$			3	15	mV
I_d	Quiescent current ON mode	$V_I = 4.2\text{ to }20\text{ V}$, $I_O = 0\text{ mA}$			0.6	1	mA
		$V_I = 4.2\text{ to }20\text{ V}$, $I_O = 250\text{ mA}$			4	6	
		OFF mode	$V_I = 6\text{ V}$		50	100	μA
SVR	Supply voltage rejection	$I_O = 5\text{ mA}$ $V_I = 5.2 \pm 1\text{ V}$	$f = 120\text{ Hz}$		73		dB
			$f = 1\text{ kHz}$		70		
			$f = 10\text{ kHz}$		55		
eN	Output noise voltage	$B = 10\text{ Hz to }100\text{ kHz}$			50	μV	
V_d	Dropout voltage ⁽¹⁾	$I_O = 250\text{ mA}$			0.4	0.6	V
		$I_O = 250\text{ mA}$, $T_A = -40\text{ to }125\text{ °C}$				0.8	V
V_{IL}	Control input logic low	$T_A = -40\text{ to }125\text{ °C}$				0.8	V
V_{IH}	Control input logic high	$T_A = -40\text{ to }125\text{ °C}$		2			V
I_I	Control input current	$V_I = 6\text{ V}$, $V_C = 6\text{ V}$			10		μA
C_O	Output bypass capacitance	ESR = 0.1 to 10 Ω , $I_O = 0\text{ to }250\text{ mA}$		2	10		μF

Notes:

⁽¹⁾For SO-8 package the maximum limit of load regulation and dropout should be increased by 20 mV.

(Refer to the test circuits, $T_A = 25\text{ °C}$, $C_I = 0.1\text{ }\mu\text{F}$, $C_O = 2.2\text{ }\mu\text{F}$ unless otherwise specified).

Table 4: L4931Cxx33 electrical characteristics

Symbol	Parameter	Test conditions	Min.	Typ.	Max.	Unit
V_O	Output voltage	$I_O = 5\text{ mA}$, $V_I = 5.3\text{ V}$	3.234	3.3	3.366	V
		$I_O = 5\text{ mA}$, $V_I = 5.3\text{ V}$, $T_A = -25\text{ to }85\text{ °C}$	3.168		3.432	
V_I	Operating input voltage	$I_O = 250\text{ mA}$			20	V
I_{out}	Output current limit			300		mA
ΔV_O	Line regulation	$V_I = 4.1\text{ to }20\text{ V}$, $I_O = 0.5\text{ mA}$		3	18	mV
ΔV_O	Load regulation ⁽¹⁾	$V_I = 4.3\text{ V}$, $I_O = 0.5\text{ to }250\text{ mA}$		3	18	mV
I_d	Quiescent current ON mode	$V_I = 4.3\text{ to }20\text{ V}$, $I_O = 0\text{ mA}$		0.6	1	mA
		$V_I = 4.3\text{ to }20\text{ V}$, $I_O = 250\text{ mA}$		4	6	
	OFF mode	$V_I = 6\text{ V}$		50	100	μA
SVR	Supply voltage rejection	$I_O = 5\text{ mA}$ $V_I = 5.3 \pm 1\text{ V}$		73		dB
				70		
				55		
eN	Output noise voltage	$B = 10\text{ Hz to }100\text{ kHz}$		50		μV
V_d	Dropout voltage ⁽¹⁾	$I_O = 250\text{ mA}$		0.4	0.6	V
		$I_O = 250\text{ mA}$, $T_A = -40\text{ to }125\text{ °C}$			0.8	V
V_{IL}	Control input logic low	$T_A = -40\text{ to }125\text{ °C}$			0.8	V
V_{IH}	Control input logic high	$T_A = -40\text{ to }125\text{ °C}$	2			V
I_I	Control input current	$V_I = 6\text{ V}$, $V_C = 6\text{ V}$		10		μA
C_O	Output bypass capacitance	ESR = 0.1 to 10 Ω , $I_O = 0\text{ to }250\text{ mA}$	2	10		μF

Notes:

⁽¹⁾For SO-8 package the maximum limit of load regulation and dropout should be increased by 20 mV.

(Refer to the test circuits, $T_A = -40$ to 125 °C, $C_I = 0.1$ μ F, $C_O = 2.2$ μ F unless otherwise specified).

Table 5: L4931Cxx33-TRY (automotive-grade) electrical characteristics

Symbol	Parameter	Test conditions	Min.	Typ.	Max.	Unit
V_O	Output voltage	$I_O = 5$ mA, $V_I = 5.3$ V $T_A = 25$ °C	3.234	3.3	3.366	V
		$I_O = 5$ mA, $V_I = 5.3$ V	3.168		3.432	
V_I	Operating input voltage	$I_O = 250$ mA			20	V
I_{out}	Output current limit	$T_A = 25$ °C		300		mA
ΔV_O	Line regulation	$V_I = 4.1$ to 20 V, $I_O = 0.5$ mA			20	mV
ΔV_O	Load regulation	$V_I = 4.3$ V, $I_O = 0.5$ to 250 mA			38	mV
I_d	Quiescent current ON mode	$V_I = 4.3$ to 20 V, $I_O = 0$ mA			1	mA
		$V_I = 4.3$ to 20 V, $I_O = 250$ mA			6	
	OFF mode	$V_I = 6$ V			100	μ A
SVR	Supply voltage rejection	$I_O = 5$ mA $V_I = 5.3 \pm 1$ V $T_A = 25$ °C	$f = 120$ Hz	73		dB
			$f = 1$ kHz	70		
			$f = 10$ kHz	55		
eN	Output noise voltage	B = 10 Hz to 100 kHz, $T_A = 25$ °C		50		μ V
V_d	Dropout voltage	$I_O = 250$ mA, $T_A = 25$ °C		0.4	0.6	V
		$I_O = 250$ mA			0.82	V
V_{IL}	Control input logic low				0.82	V
V_{IH}	Control input logic high		2			V
I_I	Control input current	$V_I = 6$ V, $V_C = 6$ V, $T_A = 25$ °C		10		μ A
C_O	Output bypass capacitance	ESR = 0.1 to 10 Ω , $I_O = 0$ to 250 mA, $T_A = 25$ °C	2	10		μ F

(Refer to the test circuits, $T_A = 25\text{ °C}$, $C_I = 0.1\text{ }\mu\text{F}$, $C_O = 2.2\text{ }\mu\text{F}$ unless otherwise specified).

Table 6: L4931ABxx35 electrical characteristics

Symbol	Parameter	Test conditions	Min.	Typ.	Max.	Unit
V_O	Output voltage	$I_O = 5\text{ mA}$, $V_I = 5.5\text{ V}$	3.465	3.5	3.535	V
		$I_O = 5\text{ mA}$, $V_I = 5.5\text{ V}$ $T_A = -25\text{ to }85\text{ °C}$	3.43		3.57	
V_I	Operating input voltage	$I_O = 250\text{ mA}$			20	V
I_{out}	Output current limit			300		mA
ΔV_O	Line regulation	$V_I = 4.2\text{ to }20\text{ V}$, $I_O = 0.5\text{ mA}$		3	15	mV
ΔV_O	Load regulation ⁽¹⁾	$V_I = 4.4\text{ V}$, $I_O = 0.5\text{ to }250\text{ mA}$		3	15	mV
I_d	Quiescent current ON mode	$V_I = 4.4\text{ to }20\text{ V}$, $I_O = 0\text{ mA}$		0.6	1	mA
		$V_I = 4.4\text{ to }20\text{ V}$, $I_O = 250\text{ mA}$		4	6	
	OFF mode	$V_I = 6\text{ V}$		50	100	μA
SVR	Supply voltage rejection	$I_O = 5\text{ mA}$ $V_I = 5.4 \pm 1\text{ V}$		73		dB
				70		
				55		
eN	Output noise voltage	B = 10 Hz to 100 kHz		50		μV
V_d	Dropout voltage ⁽¹⁾	$I_O = 250\text{ mA}$		0.4	0.6	V
		$I_O = 250\text{ mA}$, $T_A = -40\text{ to }125\text{ °C}$			0.8	V
V_{IL}	Control input logic low	$T_A = -40\text{ to }125\text{ °C}$			0.8	V
V_{IH}	Control input logic high	$T_A = -40\text{ to }125\text{ °C}$	2			V
I_I	Control input current	$V_I = 6\text{ V}$, $V_C = 6\text{ V}$		10		μA
C_O	Output bypass capacitance	ESR = 0.1 to 10 Ω , $I_O = 0\text{ to }250\text{ mA}$	2	10		μF

Notes:

⁽¹⁾For SO-8 package the maximum limit of load regulation and dropout should be increased by 20 mV.

(Refer to the test circuits, $T_A = 25\text{ °C}$, $C_I = 0.1\text{ }\mu\text{F}$, $C_O = 2.2\text{ }\mu\text{F}$ unless otherwise specified).

Table 7: L4931Cxx35 electrical characteristics

Symbol	Parameter	Test conditions	Min.	Typ.	Max.	Unit	
V_O	Output voltage	$I_O = 5\text{ mA}$, $V_I = 5.5\text{ V}$	3.43	3.5	3.57	V	
		$I_O = 5\text{ mA}$, $V_I = 5.5\text{ V}$ $T_A = -25\text{ to }85\text{ °C}$	3.36		3.64		
V_I	Operating input voltage	$I_O = 250\text{ mA}$			20	V	
I_{out}	Output current limit			300		mA	
ΔV_O	Line regulation	$V_I = 4.3\text{ to }20\text{ V}$, $I_O = 0.5\text{ mA}$		3	18	mV	
ΔV_O	Load regulation ⁽¹⁾	$V_I = 4.5\text{ V}$, $I_O = 0.5\text{ to }250\text{ mA}$		3	18	mV	
I_d	Quiescent current ON mode	$V_I = 4.5\text{ to }20\text{ V}$, $I_O = 0\text{ mA}$		0.6	1	mA	
		$V_I = 4.5\text{ to }20\text{ V}$, $I_O = 250\text{ mA}$		4	6		
	OFF mode	$V_I = 6\text{ V}$		50	100	μA	
SVR	Supply voltage rejection	$I_O = 5\text{ mA}$ $V_I = 5.5 \pm 1\text{ V}$	$f = 120\text{ Hz}$		73		dB
			$f = 1\text{ kHz}$		70		
			$f = 10\text{ kHz}$		55		
eN	Output noise voltage	$B = 10\text{ Hz to }100\text{ kHz}$		50		μV	
V_d	Dropout voltage ⁽¹⁾	$I_O = 250\text{ mA}$		0.4	0.6	V	
		$I_O = 250\text{ mA}$, $T_A = -40\text{ to }125\text{ °C}$			0.8	V	
V_{IL}	Control input logic low	$T_A = -40\text{ to }125\text{ °C}$			0.8	V	
V_{IH}	Control input logic high	$T_A = -40\text{ to }125\text{ °C}$	2			V	
I_i	Control input current	$V_I = 6\text{ V}$, $V_C = 6\text{ V}$		10		μA	
C_O	Output bypass capacitance	ESR = 0.1 to 10 Ω , $I_O = 0\text{ to }250\text{ mA}$	2	10		μF	

Notes:⁽¹⁾For SO-8 package the maximum limit of load regulation and dropout should be increased by 20 mV.

(Refer to the test circuits, $T_A = 25\text{ °C}$, $C_I = 0.1\text{ }\mu\text{F}$, $C_O = 2.2\text{ }\mu\text{F}$ unless otherwise specified).

Table 8: L4931ABxx50 electrical characteristics

Symbol	Parameter	Test conditions	Min.	Typ.	Max.	Unit
V_O	Output voltage	$I_O = 5\text{ mA}$, $V_I = 7\text{ V}$	4.95	5	5.05	V
		$I_O = 5\text{ mA}$, $V_I = 7\text{ V}$, $T_A = -25\text{ to }85\text{ °C}$	4.9		5.1	
V_I	Operating input voltage	$I_O = 250\text{ mA}$			20	V
I_{out}	Output current limit			300		mA
ΔV_O	Line regulation	$V_I = 5.8\text{ to }20\text{ V}$, $I_O = 0.5\text{ mA}$		3.5	17.5	mV
ΔV_O	Load regulation ⁽¹⁾	$V_I = 6\text{ V}$, $I_O = 0.5\text{ to }250\text{ mA}$		3	15	mV
I_d	Quiescent current ON mode	$V_I = 6\text{ to }20\text{ V}$, $I_O = 0\text{ mA}$		0.6	1	mA
		$V_I = 6\text{ to }20\text{ V}$, $I_O = 250\text{ mA}$		4	6	
	OFF mode	$V_I = 6\text{ V}$		50	100	μA
SVR	Supply voltage rejection	$I_O = 5\text{ mA}$ $V_I = 7 \pm 1\text{ V}$	$f = 120\text{ Hz}$	70		dB
			$f = 1\text{ kHz}$	67		
			$f = 10\text{ kHz}$	55		
eN	Output noise voltage	$B = 10\text{ Hz to }100\text{ kHz}$		50		μV
V_d	Dropout voltage ⁽¹⁾	$I_O = 250\text{ mA}$		0.4	0.6	V
		$I_O = 250\text{ mA}$, $T_A = -40\text{ to }125\text{ °C}$			0.8	V
V_{IL}	Control input logic low	$T_A = -40\text{ to }125\text{ °C}$			0.8	V
V_{IH}	Control input logic high	$T_A = -40\text{ to }125\text{ °C}$	2			V
I_I	Control input current	$V_I = 6\text{ V}$, $V_C = 6\text{ V}$		10		μA
C_O	Output bypass capacitance	ESR = $0.1\text{ to }10\text{ }\Omega$, $I_O = 0\text{ to }250\text{ mA}$	2	10		μF

Notes:⁽¹⁾For SO-8 package the maximum limit of load regulation and dropout should be increased by 20 mV.

(Refer to the test circuits, $T_A = 25\text{ °C}$, $C_I = 0.1\text{ }\mu\text{F}$, $C_O = 2.2\text{ }\mu\text{F}$ unless otherwise specified).

Table 9: L4931Cxx50 electrical characteristics

Symbol	Parameter	Test conditions	Min.	Typ.	Max.	Unit
V_O	Output voltage	$I_O = 5\text{ mA}$, $V_I = 7\text{ V}$	4.9	5	5.1	V
		$I_O = 5\text{ mA}$, $V_I = 7\text{ V}$, $T_A = -25\text{ to }85\text{ °C}$	4.8		5.2	
V_I	Operating input voltage	$I_O = 250\text{ mA}$			20	V
I_{out}	Output current limit			300		mA
ΔV_O	Line regulation	$V_I = 5.8\text{ to }20\text{ V}$, $I_O = 0.5\text{ mA}$		3.5	17.5	mV
ΔV_O	Load regulation ⁽¹⁾	$V_I = 6\text{ V}$, $I_O = 0.5\text{ to }250\text{ mA}$		3	15	mV
I_d	Quiescent current ON mode	$V_I = 6\text{ to }20\text{ V}$, $I_O = 0\text{ mA}$		0.6	1	mA
		$V_I = 6\text{ to }20\text{ V}$, $I_O = 250\text{ mA}$		4	6	
	OFF mode	$V_I = 6\text{ V}$		50	100	μA
SVR	Supply voltage rejection	$I_O = 5\text{ mA}$ $V_I = 7 \pm 1\text{ V}$		70		dB
				67		
				55		
eN	Output noise voltage	$B = 10\text{ Hz to }100\text{ kHz}$		50		μV
V_d	Dropout voltage ⁽¹⁾	$I_O = 250\text{ mA}$		0.4	0.6	V
		$I_O = 250\text{ mA}$, $T_A = -40\text{ to }125\text{ °C}$			0.8	V
V_{IL}	Control input logic low	$T_A = -40\text{ to }125\text{ °C}$			0.8	V
V_{IH}	Control input logic high	$T_A = -40\text{ to }125\text{ °C}$	2			V
I_I	Control input current	$V_I = 6\text{ V}$, $V_C = 6\text{ V}$		10		μA
C_O	Output bypass capacitance	ESR = 0.1 to 10 Ω , $I_O = 0\text{ to }250\text{ mA}$	2	10		μF

Notes:

⁽¹⁾For SO-8 package the maximum limit of load regulation and dropout should be increased by 20 mV.

(Refer to the test circuits, $T_A = 25\text{ °C}$, $C_I = 0.1\text{ }\mu\text{F}$, $C_O = 2.2\text{ }\mu\text{F}$ unless otherwise specified).

Table 10: L4931ABxx120 electrical characteristics

Symbol	Parameter	Test conditions	Min.	Typ.	Max.	Unit
V_O	Output voltage	$I_O = 5\text{ mA}$, $V_I = 14\text{ V}$	11.88	12	12.12	V
		$I_O = 5\text{ mA}$, $V_I = 14\text{ V}$, $T_A = -25\text{ to }85\text{ °C}$	11.76		12.24	
V_I	Operating input voltage	$I_O = 250\text{ mA}$			20	V
I_{out}	Output current limit			300		mA
ΔV_O	Line regulation	$V_I = 12.8\text{ to }20\text{ V}$, $I_O = 0.5\text{ mA}$		4	20	mV
ΔV_O	Load regulation ⁽¹⁾	$V_I = 13\text{ V}$, $I_O = 0.5\text{ to }250\text{ mA}$		3	15	mV
I_d	Quiescent current ON mode	$V_I = 13\text{ to }20\text{ V}$, $I_O = 0\text{ mA}$		0.8	1.6	mA
		$V_I = 13\text{ to }20\text{ V}$, $I_O = 250\text{ mA}$		4.5	7	
	OFF mode	$V_I = 6\text{ V}$		90	180	μA
SVR	Supply voltage rejection	$I_O = 5\text{ mA}$ $V_I = 14 \pm 1\text{ V}$	$f = 120\text{ Hz}$	64		dB
			$f = 1\text{ kHz}$	61		
			$f = 10\text{ kHz}$	55		
eN	Output noise voltage	$B = 10\text{ Hz to }100\text{ kHz}$		50		μV
V_d	Dropout voltage ⁽¹⁾	$I_O = 250\text{ mA}$		0.4	0.6	V
		$I_O = 250\text{ mA}$, $T_A = -40\text{ to }125\text{ °C}$			0.8	V
V_{IL}	Control input logic low	$T_A = -40\text{ to }125\text{ °C}$			0.8	V
V_{IH}	Control input logic high	$T_A = -40\text{ to }125\text{ °C}$	2			V
I_I	Control input current	$V_I = 6\text{ V}$, $V_C = 6\text{ V}$		10		μA
C_O	Output bypass capacitance	ESR = 0.1 to 10 Ω , $I_O = 0\text{ to }250\text{ mA}$	2	10		μF

Notes:⁽¹⁾For SO-8 package the maximum limit of load regulation and dropout should be increased by 20 mV.

(Refer to the test circuits, $T_A = 25\text{ °C}$, $C_I = 0.1\text{ }\mu\text{F}$, $C_O = 2.2\text{ }\mu\text{F}$ unless otherwise specified).

Table 11: L4931Cxx120 electrical characteristics

Symbol	Parameter	Test conditions	Min.	Typ.	Max.	Unit
V_O	Output voltage	$I_O = 5\text{ mA}$, $V_I = 14\text{ V}$	11.76	12	12.24	V
		$I_O = 5\text{ mA}$, $V_I = 14\text{ V}$, $T_A = -25\text{ to }85\text{ °C}$	11.52		12.48	
V_I	Operating input voltage	$I_O = 250\text{ mA}$			20	V
I_{out}	Output current limit			300		mA
ΔV_O	Line regulation	$V_I = 12.9\text{ to }20\text{ V}$, $I_O = 0.5\text{ mA}$		4	24	mV
ΔV_O	Load regulation ⁽¹⁾	$V_I = 13.1\text{ V}$, $I_O = 0.5\text{ to }250\text{ mA}$		3	18	mV
I_d	Quiescent current ON mode	$V_I = 13.1\text{ to }20\text{ V}$, $I_O = 0\text{ mA}$		0.8	1.6	mA
		$V_I = 13.1\text{ to }20\text{ V}$, $I_O = 250\text{ mA}$		4.5	7	
	OFF mode	$V_I = 6\text{ V}$		90	180	μA
SVR	Supply voltage rejection	$I_O = 5\text{ mA}$ $V_I = 14.1 \pm 1\text{ V}$	$f = 120\text{ Hz}$	64		dB
			$f = 1\text{ kHz}$	61		
			$f = 10\text{ kHz}$	55		
eN	Output noise voltage	$B = 10\text{ Hz to }100\text{ kHz}$		50		μV
V_d	Dropout voltage ⁽¹⁾	$I_O = 250\text{ mA}$		0.4	0.6	V
		$I_O = 250\text{ mA}$, $T_A = -40\text{ to }125\text{ °C}$			0.8	V
V_{IL}	Control input logic low	$T_A = -40\text{ to }125\text{ °C}$			0.8	V
V_{IH}	Control input logic high	$T_A = -40\text{ to }125\text{ °C}$	2			V
I_i	Control input current	$V_I = 6\text{ V}$, $V_C = 6\text{ V}$		10		μA
C_O	Output bypass capacitance	ESR = $0.1\text{ to }10\text{ }\Omega$, $I_O = 0\text{ to }250\text{ mA}$	2	10		μF

Notes:⁽¹⁾For SO-8 package the maximum limit of load regulation and dropout should be increased by 20 mV.

6 Typical application

Figure 4: Line regulation vs temperature

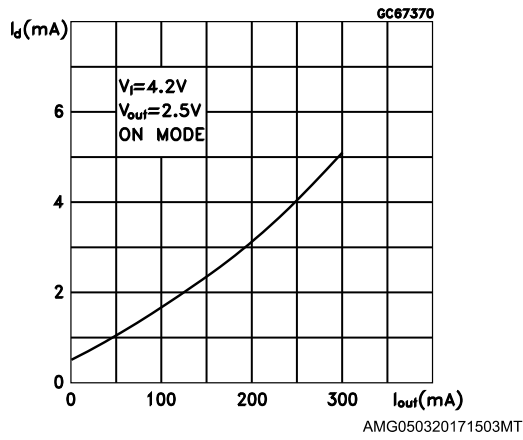

Figure 5: Dropout voltage vs temperature

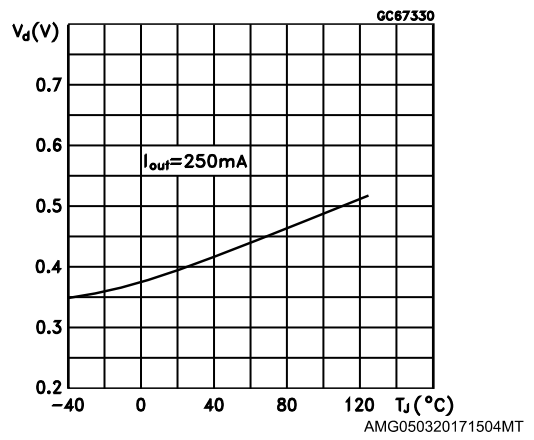

Figure 6: Supply current vs input voltage

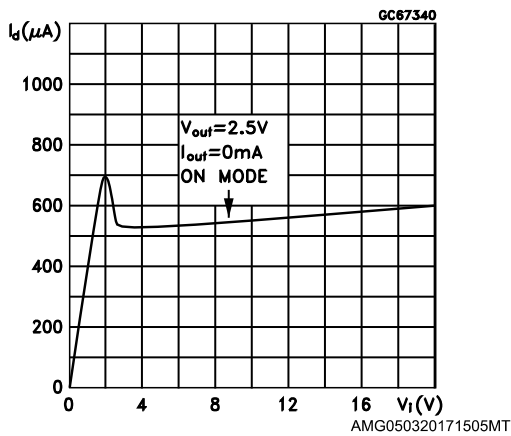

Figure 7: Supply current vs temperature

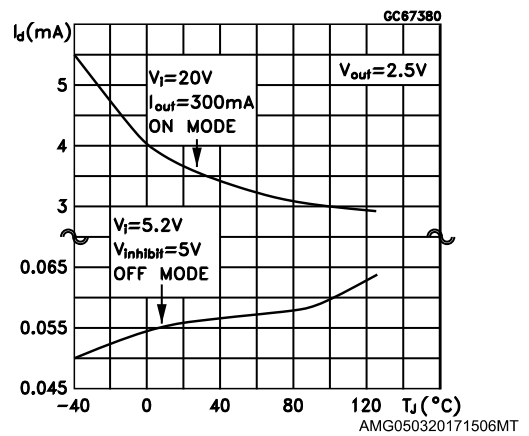

Figure 8: Short-circuit current vs dropout voltage

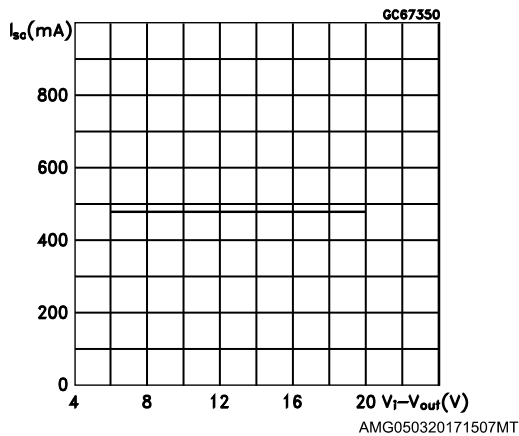
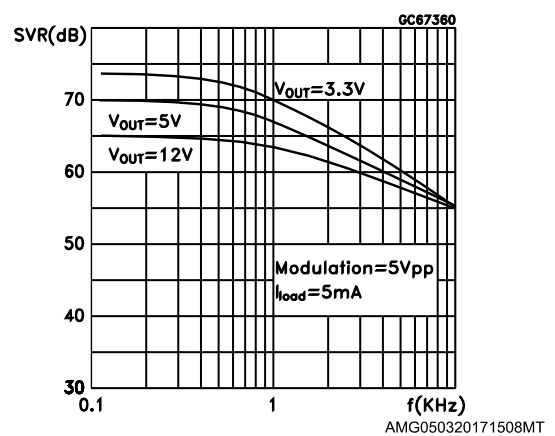

Figure 9: SVR vs input voltage signal frequency



7 Package information

In order to meet environmental requirements, ST offers these devices in different grades of ECOPACK® packages, depending on their level of environmental compliance. ECOPACK® specifications, grade definitions and product status are available at: www.st.com. ECOPACK® is an ST trademark.

7.1 TO-92 package information

Figure 10: TO-92 package outline

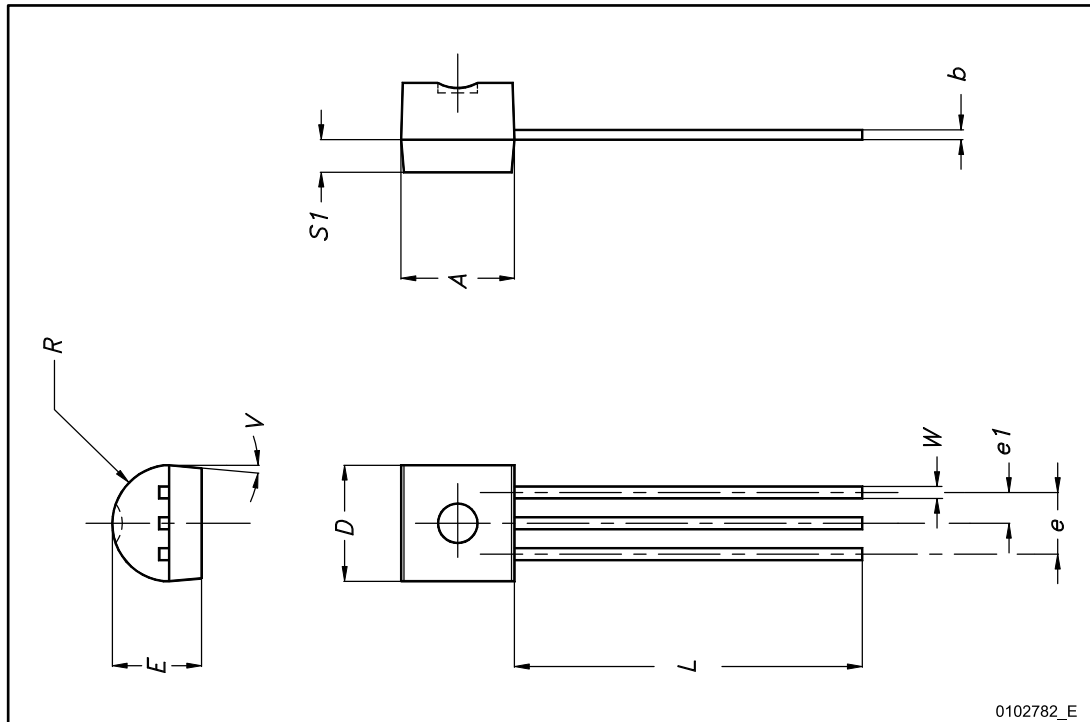

0102782_E

Table 12: TO-92 mechanical data

Dim.	mm		
	Min.	Typ.	Max.
A	4.32		4.95
b	0.36		0.51
D	4.45		4.95
E	3.30		3.94
e	2.41		2.67
e1	1.14		1.40
L	12.70		15.49
R	2.16		2.41
S1	0.92		1.52
W	0.41		0.56
V		5°	

7.2 TO-92 Ammopak packing information

Figure 11: TO-92 Ammopak tape and reel outline

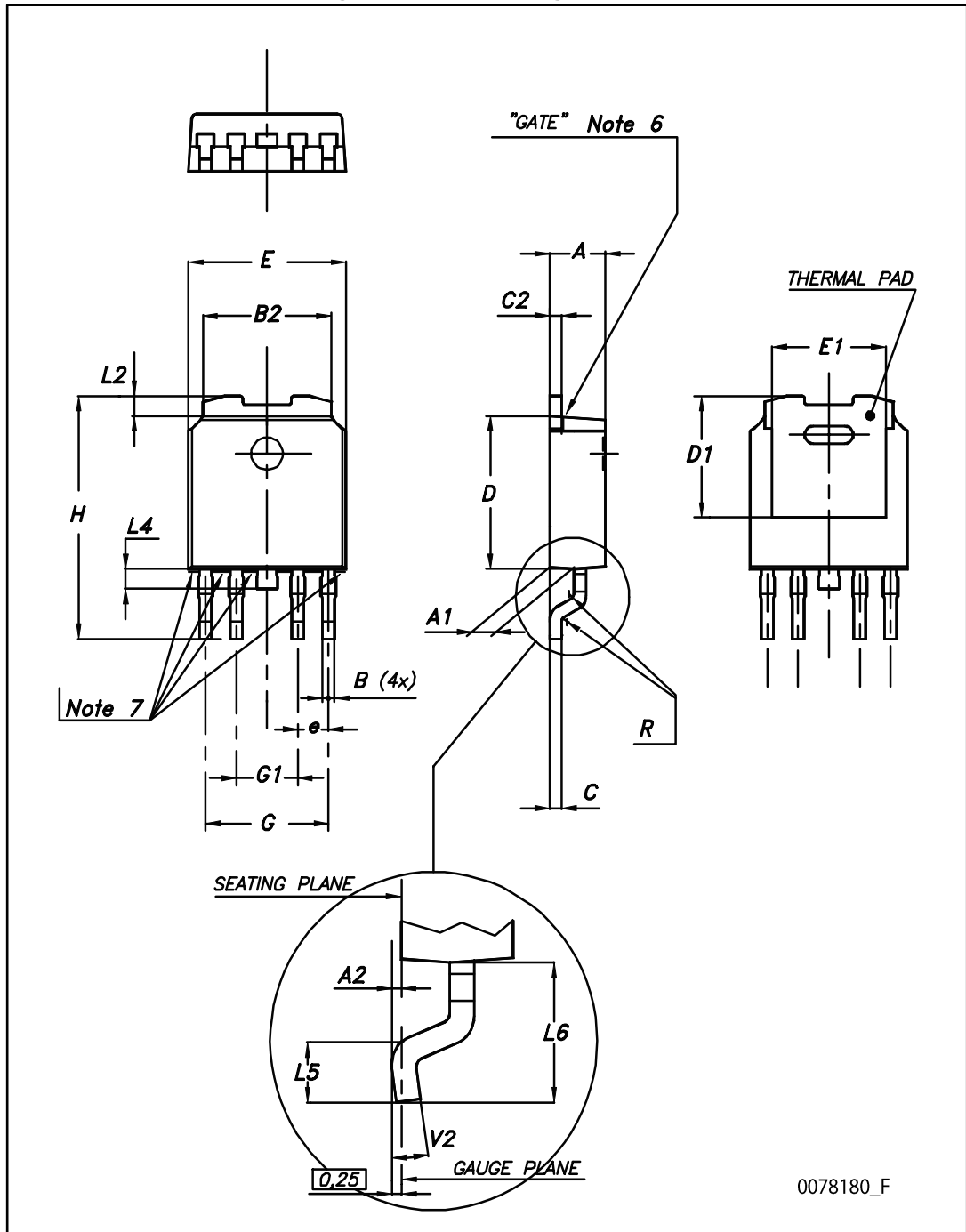

Table 13: TO-92 Ammopak tape and reel mechanical data

Dim.	mm		
	Min.	Typ.	Max.
A1			4.80
T			3.80
T1			1.60
T2			2.30
d	0.45	0.47	0.48
P0	12.50	12.70	12.90
P2	5.65	6.35	7.05
F1, F2	2.40	2.50	2.94
F3	4.98	5.08	5.48
delta H	-2.00		2.00
W	17.50	18.00	19.00
W0	5.5	6.00	6.5
W1	8.50	9.00	9.25
W2			0.50
H		18.50	21
H3	0.5	1	2
H0	15.50	16.00	18.8
H1		25.0	27.0
D0	3.80	4.00	4.20
t			0.90
L			11.00
I1	3.00		
delta P	-1.00		1.00

7.3 PPAK package information

Figure 12: PPAK package outline



0078180_F

Table 14: PPAK mechanical data

Dim.	mm		
	Min.	Typ.	Max.
A	2.2		2.4
A1	0.9		1.1
A2	0.03		0.23
B	0.4		0.6
B2	5.2		5.4
C	0.45		0.6
C2	0.48		0.6
D	6		6.2
D1		5.1	
E	6.4		6.6
E1		4.7	
e		1.27	
G	4.9		5.25
G1	2.38		2.7
H	9.35		10.1
L2		0.8	1
L4	0.6		1
L5	1		
L6		2.8	
R		0.20	
V2	0°		8°

7.4 DPAK package information

Figure 13: DPAK package outline



0068772_A_21

Table 15: DPAK mechanical data

Dim.	mm		
	Min.	Typ.	Max.
A	2.20		2.40
A1	0.90		1.10
A2	0.03		0.23
b	0.64		0.90
b4	5.20		5.40
c	0.45		0.60
c2	0.48		0.60
D	6.00		6.20
D1		5.10	
E	6.40		6.60
E1		4.70	
e		2.28	
e1	4.40		4.60
H	9.35		10.10
L	1.00		1.50
(L1)		2.80	
L2		0.80	
L4	0.60		1.00
R		0.20	
V2	0°		8°

Figure 14: DPAK recommended footprint (dimensions are in mm)

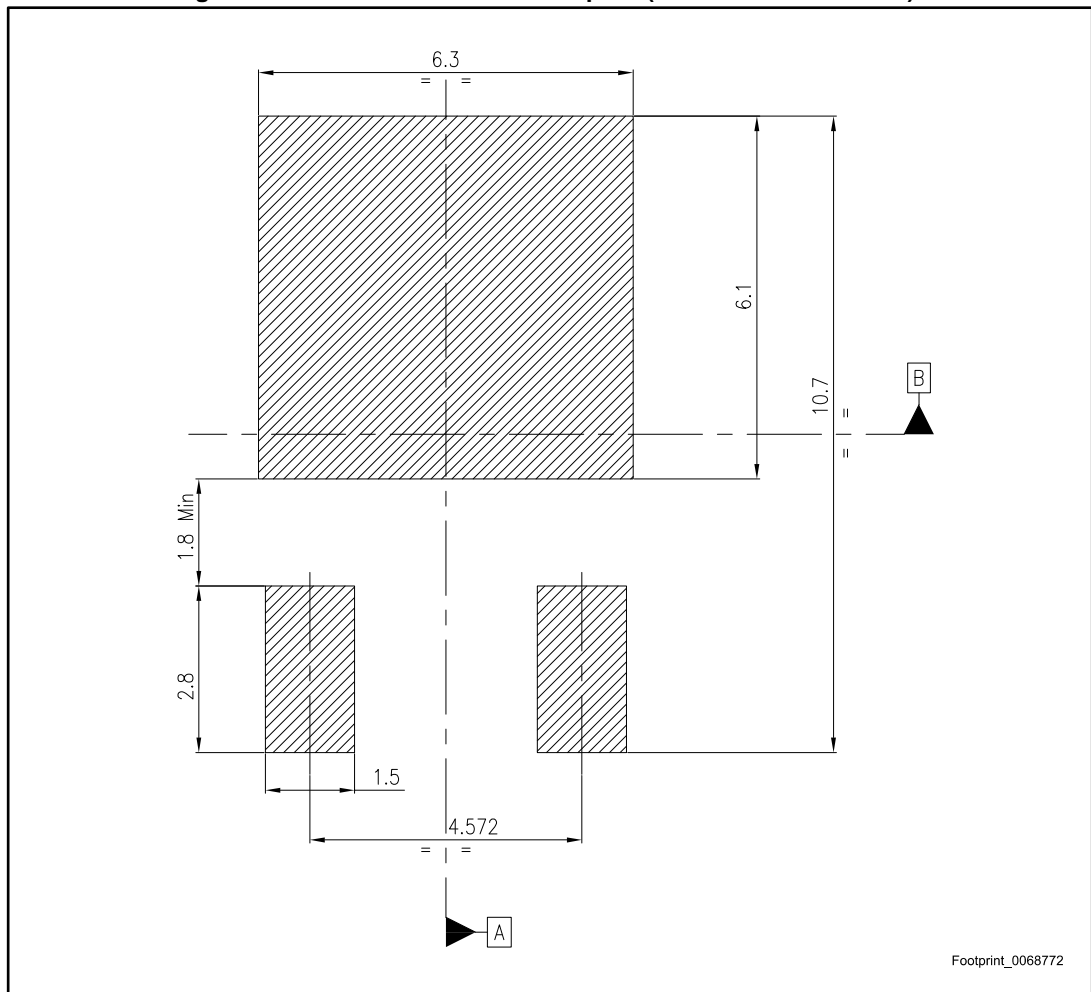

7.5 PPAK and DPAK paking information

Figure 15: PPAK and DPAK tape



Figure 16: PPAK and DPAK reel



Table 16: PPAK and DPAK tape and reel mechanical data

Tape			Reel		
Dim.	mm		Dim.	mm	
	Min.	Max.		Min.	Max.
A0	6.8	7	A		330
B0	10.4	10.6	B	1.5	
B1		12.1	C	12.8	13.2
D	1.5	1.6	D	20.2	
D1	1.5		G	16.4	18.4
E	1.65	1.85	N	50	
F	7.4	7.6	T		22.4
K0	2.55	2.75			
P0	3.9	4.1	Base qty.		2500
P1	7.9	8.1	Bulk qty.		2500
P2	1.9	2.1			
R	40				
T	0.25	0.35			
W	15.7	16.3			

7.6 SO-8 package information

Figure 17: SO-8 package outline

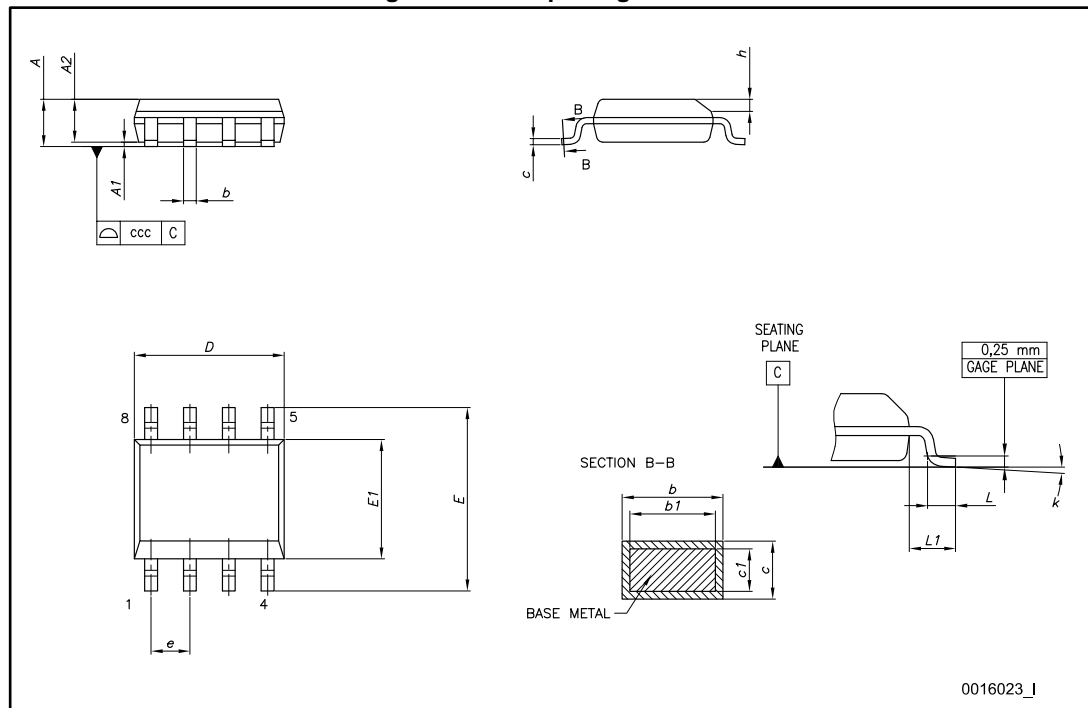

Table 17: SO-8 mechanical data

Dim.	mm		
	Min.	Typ.	Max.
A			1.75
A1	0.10		0.25
A2	1.25		
b	0.28		0.48
c	0.17		0.23
D	4.80	4.90	5.00
E	5.80	6.00	6.20
E1	3.80	3.90	4.00
e		1.27	
h	0.25		0.50
L	0.40		1.27
L1		1.04	
k	0°		8°
ccc			0.10

Figure 18: SO-8 recommended footprint



7.7 SO-8 packing information

Figure 19: SO8-batwing tape and reel outline

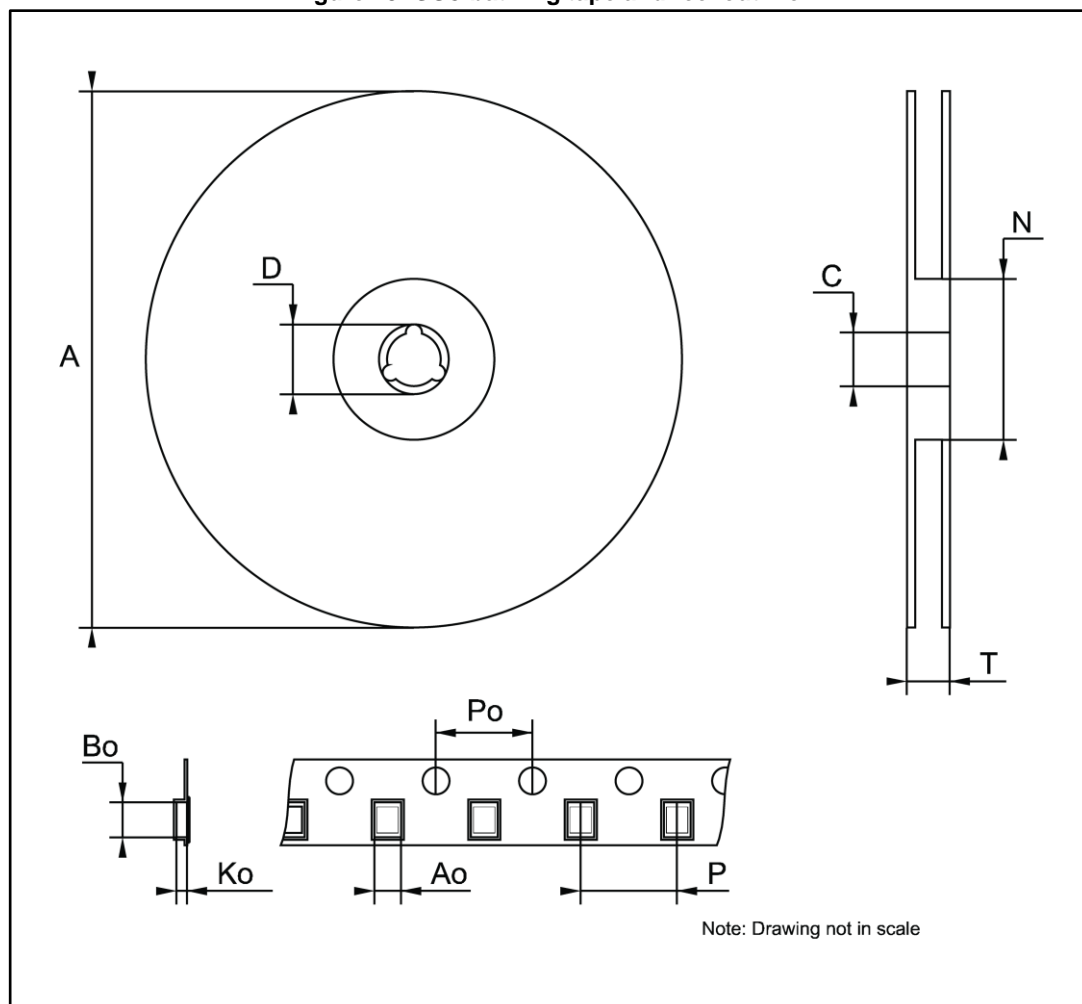

Table 18: SO8-batwing mechanical data

Dim.	mm		
	Min.	Typ.	Max.
A			330
C	12.8		13.2
D	20.2		
N	60		
T			22.4
A0	8.1		8.5
B0	5.5		5.9
K0	2.1		2.3
P0	3.9		4.1
P	7.9		8.1

8 Ordering information

Table 19: Order codes

Package					Output voltage
TO-92	PPAK	DPAK	SO-8	SO-8 (automotive-grade)	
			L4931CD27-TR	L4931CD27-TRY ⁽¹⁾	2.7 V
L4931CZ33-AP		L4931CDT33-TR	L4931CD33-TR	L4931CD33-TRY ⁽¹⁾	3.3 V
		L4931ABDT33-TR	L4931ABD33-TR		3.3 V
			L4931CD35-TR		3.5 V
		L4931ABDT35TR	L4931ABD35-TR		3.5 V
L4931CZ50-AP	L4931CPT50-TR	L4931CDT50-TR	L4931CD50-TR		5 V
		L4931ABDT50-TR	L4931ABD50-TR		5 V
			L4931CD80-TR		8 V
		L4931ABDT80-TR			8 V
			L4931CD120-TR		12 V
			L4931ABD120TR		12 V

Notes:

⁽¹⁾Qualified and characterized according to AEC Q100 and Q003 or equivalent, advanced screening according to AEC Q001 and Q002 or equivalent.

9 Revision history

Table 20: Document revision history

Date	Revision	Changes
21-Jun-2004	11	Document updating.
14-Jun-2006	12	Order codes updated.
31-Jan-2008	13	Added: Table 1 and new order codes for Automotive grade products.
20-Feb-2008	14	Modified: Table 23 on page 36.
11-Mar-2008	15	Modified: Table 1 on page 1 and Table 23 on page 36.
15-Jul-2008	16	Modified: Table 1 on page 1 and Table 23 on page 36.
18-Aug-2008	17	Modified: Table 23 on page 36.
30-Oct-2013	18	<p>Changed the L4931ABxx and L4931Cxx to L4931.</p> <p>Updated: Description in cover page.</p> <p>Deleted table1: Device summary.</p> <p>Updated Figure 2: Pin connections (top view), Table 2: Thermal data, Section 5: Electrical characteristics and Section 7: Package mechanical data.</p> <p>Added Section 8: Packaging mechanical data.</p> <p>Minor text changes.</p>
02-Aug-2017	19	<p>Updated features in cover page.</p> <p>Deleted table 3: L4931Cxx27 electrical characteristics, table 4: L4931Cxx27-TRY (automotive-grade) electrical characteristics, table 12:L4931ABxx80 electrical characteristics, table 13: L4931Cxx80 electrical characteristics.</p> <p>Updated Table 19: "Order codes".</p> <p>Minor text changes.</p>

IMPORTANT NOTICE – PLEASE READ CAREFULLY

STMicroelectronics NV and its subsidiaries ("ST") reserve the right to make changes, corrections, enhancements, modifications, and improvements to ST products and/or to this document at any time without notice. Purchasers should obtain the latest relevant information on ST products before placing orders. ST products are sold pursuant to ST's terms and conditions of sale in place at the time of order acknowledgement.

Purchasers are solely responsible for the choice, selection, and use of ST products and ST assumes no liability for application assistance or the design of Purchasers' products.

No license, express or implied, to any intellectual property right is granted by ST herein.

Resale of ST products with provisions different from the information set forth herein shall void any warranty granted by ST for such product.



ST and the ST logo are trademarks of ST. All other product or service names are the property of their respective owners.

Information in this document supersedes and replaces information previously supplied in any prior versions of this document.

© 2017 STMicroelectronics – All rights reserved

Looking for pricing, stock, or lifecycle information?

Click below to explore more details on WIN SOURCE:

-  [View L4931CD25 on WIN SOURCE](#)
-  [STMicroelectronics Information](#)

Optimize Your Supply Chain with WIN SOURCE Solutions

-  Global Sourcing Solution
-  Obsolete Management
-  Cost Control Management
-  Shortage Management
-  Alternative Solution
-  Excess Inventory Management