



**THE DATASHEET OF
LD3985J18R**



Ultra low drop and low noise BiCMOS voltage regulators

Datasheet - production data

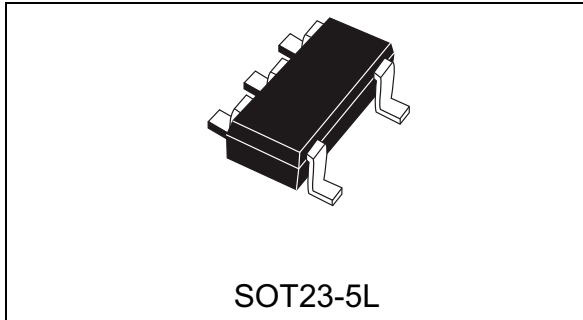

Power supply rejection is better than 60 dB at low frequencies and rolls off at 10 kHz. High power supply rejection is maintained down to low input voltage levels common to battery operated circuits. Shutdown logic control function is available, this means that when the device is used as local regulator, it is possible to put a part of the board in standby, decreasing the total power consumption. The LD3985 is designed to work with low ESR ceramic capacitors. Typical applications are in mobile phones and similar battery-powered wireless systems.

Features

- Input voltage from 2.5 V to 6 V
- Stable with low ESR ceramic capacitors
- Ultra low-dropout voltage (60 mV typ. at 150 mA load, 0.4 mV typ. at 1 mA load)
- Very low quiescent current (85 μ A typ. at no load, 170 μ A typ. at 150 mA load; max. 1.5 μ A in OFF mode)
- Guaranteed output current up to 150 mA
- Wide range of output voltages: 1.22 V; 1.8 V; 2.5 V; 2.7 V; 2.8 V; 2.9 V; 3 V; 3.3 V; 4.7 V
- Fast turn-on time: typ. 200 μ s [$C_O = 1 \mu$ F, $C_{BYP} = 10$ nF and $I_O = 1$ mA]
- Logic-controlled electronic shutdown
- Internal current and thermal limit
- Output low noise voltage 30 μ V_{RMS} over 10 Hz to 100 kHz
- SVR of 60 dB at 1 kHz, 50 dB at 10 kHz
- Temperature range: - 40 °C to 125 °C

Description

The LD3985 provides up to 150 mA, from 2.5 V to 6 V input voltage. The ultra low drop voltage, low quiescent current and low noise make it suitable for low power applications and in battery-powered systems. Regulator ground current increases slightly in dropout only, prolonging the battery life.

Contents

1	Diagram	3
2	Pin configuration	4
3	Typical application	5
4	Maximum ratings	6
5	Electrical characteristics	7
6	Typical performance characteristics	9
7	Package information	13
	7.1 SOT23-5L package information	13
	7.2 SOT23-5L packing information	15
8	Ordering information	16
9	Revision history	17

1 Diagram

Figure 1. Schematic diagram

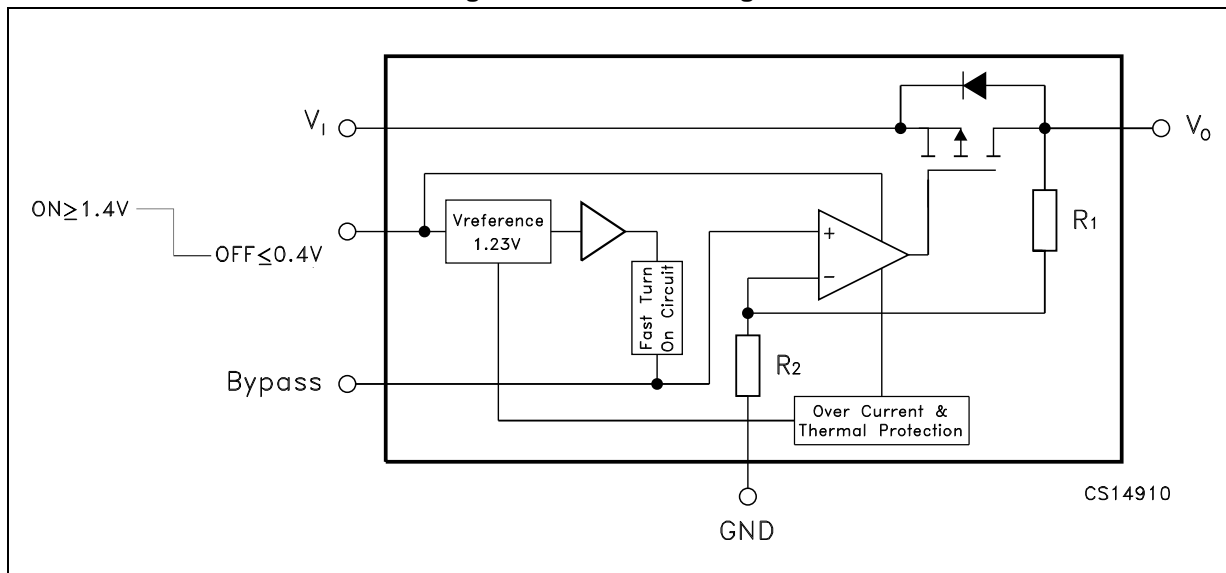

2 Pin configuration

Figure 2. Pin connection (top view)

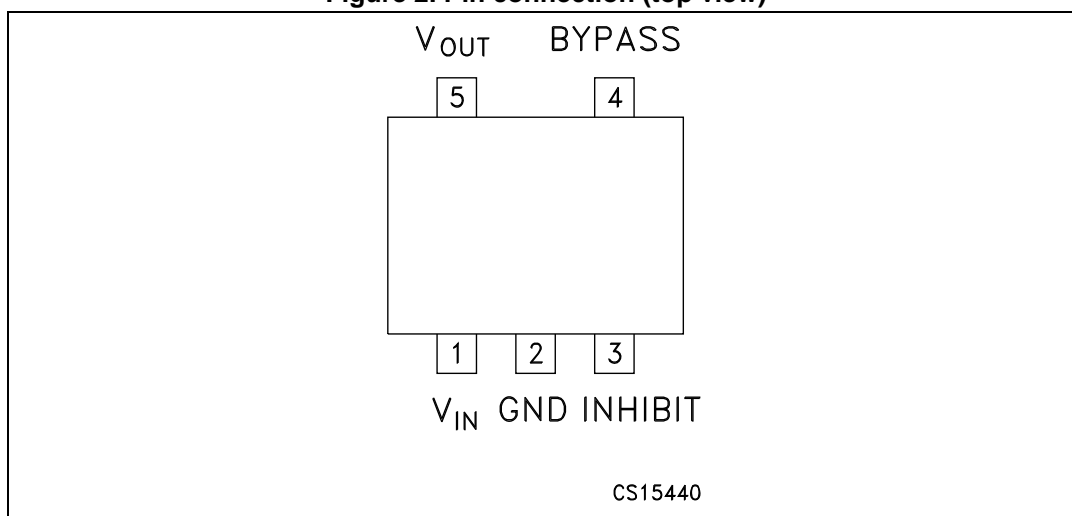
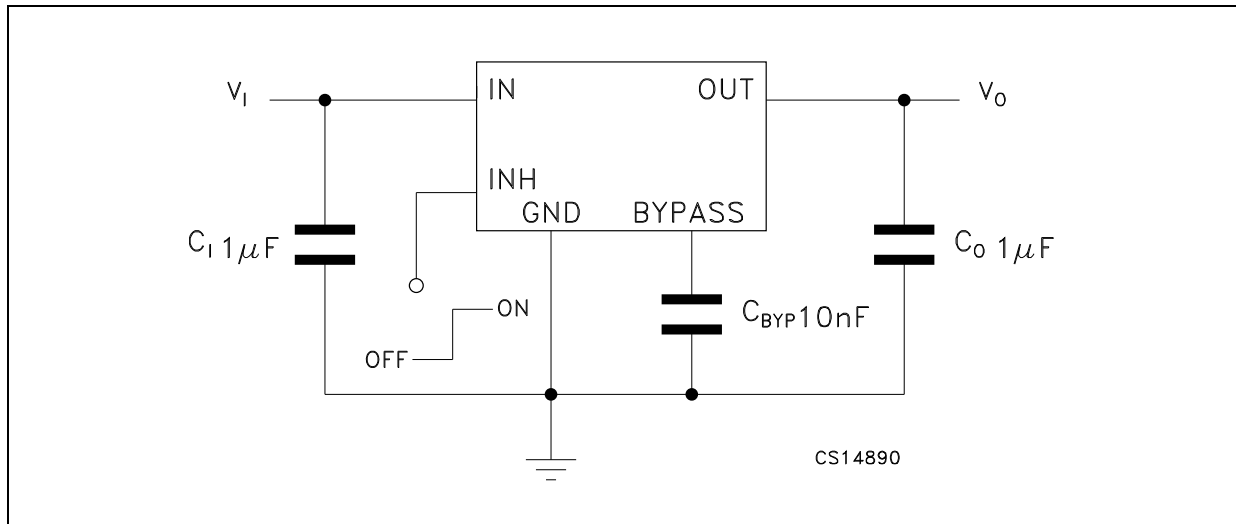

Table 1. Pin description

Pin	Symbol	Name and function
1	V_I	Input voltage of the LDO
2	GND	Common ground
3	V_{INH}	Inhibit input voltage: ON mode when $V_{INH} \geq 1.2$ V, OFF mode when $V_{INH} \leq 0.4$ V (Do not leave it floating, not internally pulled down/up)
4	BYPASS	Bypass pin: an external capacitor (usually 10 nF) has to be connected to minimize noise voltage
5	V_O	Output voltage of the LDO

3 Typical application

Figure 3. Typical application circuit



4 Maximum ratings

Table 2. Absolute maximum ratings

Symbol	Parameter	Value	Unit
V_I	DC input voltage	-0.3 to 6 ⁽¹⁾	V
V_O	DC output voltage	-0.3 to $V_I+0.3$	V
V_{INH}	Inhibit input voltage	-0.3 to $V_I+0.3$	V
I_O	Output current	Internally limited	
P_D	Power dissipation	Internally limited	
T_{STG}	Storage temperature range	-65 to 150	°C
T_{OP}	Operating junction temperature range	-40 to 125	°C

1. The input pin is able to withstand non repetitive spike of 6.5 V for 200 ms.

Note: Absolute maximum ratings are those values beyond which damage to the device may occur. Functional operation under these conditions is not implied.

Table 3. Thermal data

Symbol	Parameter	Value	Unit
R_{thJC}	Thermal resistance junction-case	81	°C/W
R_{thJA}	Thermal resistance junction-ambient	255	°C/W

5 Electrical characteristics

$T_J = 25\text{ °C}$, $V_I = V_{O(NOM)} + 0.5\text{ V}$, $C_I = 1\text{ }\mu\text{F}$, $C_{BYP} = 10\text{ nF}$, $I_O = 1\text{ mA}$, $V_{INH} = 1.4\text{ V}$, unless otherwise specified.

Table 4. Electrical characteristics

Symbol	Parameter	Test conditions	Min.	Typ.	Max.	Unit
V_I	Operating input voltage		2.5		6	V
V_O	Output voltage accuracy, $V_{O(NOM)} < 2.5\text{ V}$	$I_O = 1\text{ mA}$	-50		50	mV
		$T_J = -40\text{ to }125\text{ °C}$	-75		75	
V_O	Output voltage accuracy, $V_{O(NOM)} \geq 2.5\text{ V}$	$I_O = 1\text{ mA}$	-2		2	% of $V_{O(NOM)}$
		$T_J = -40\text{ to }125\text{ °C}$	-3		3	
ΔV_O	Line regulation ⁽¹⁾	$V_I = V_{O(NOM)} + 0.5\text{ to }6\text{ V}$ $T_J = -40\text{ to }125\text{ °C}$	-0.1		0.1	% / V
		$V_{O(NOM)} = 4.7\text{ to }5\text{ V}$	-0.19		0.19	
ΔV_O	Load regulation	$I_O = 1\text{ mA to }150\text{ mA}$, $V_{O(NOM)} < 2.5\text{ V}$ $T_J = -40\text{ to }125\text{ °C}$		0.002	0.008	% / mA
ΔV_O	Load regulation	$I_O = 1\text{ mA to }150\text{ mA}$, $V_{O(NOM)} \geq 2.5\text{ V}$		0.0004	0.002	% / mA
		$I_O = 1\text{ mA to }150\text{ mA}$, $T_J = -40\text{ to }125\text{ °C}$, $V_{O(NOM)} \geq 2.5\text{ V}$		0.0025	0.005	
ΔV_O	Output AC line regulation ⁽²⁾	$V_I = V_{O(NOM)} + 1\text{ V}$, $I_O = 150\text{ mA}$, $t_R = t_F = 30\text{ }\mu\text{s}$		1.5		mV _{PP}
I_Q	Quiescent current ON mode: $V_{INH} = 1.2\text{ V}$	$I_O = 0$		85		μA
		$I_O = 0$, $T_J = -40\text{ to }125\text{ °C}$			150	
		$I_O = 0\text{ to }150\text{ mA}$		170		
		$I_O = 0\text{ to }150\text{ mA}$, $T_J = -40\text{ to }125\text{ °C}$			250	
	OFF mode: $V_{INH} = 0.4\text{ V}$			0.003		
		$T_J = -40\text{ to }125\text{ °C}$			1.5	

Table 4. Electrical characteristics (continued)

Symbol	Parameter	Test conditions	Min.	Typ.	Max.	Unit
V _{DROP}	Dropout voltage ⁽³⁾	I _O = 1 mA		0.4		mV
		I _O = 1 mA, T _J = -40 to 125 °C			2	
		I _O = 50 mA		20		
		I _O = 50 mA, T _J = -40 to 125 °C			35	
		I _O = 100 mA		45		
		I _O = 100 mA, T _J = -40 to 125 °C			70	
		I _O = 150 mA		60		
		I _O = 150 mA, T _J = -40 to 125 °C			100	
I _{SC}	Short-circuit current	R _L = 0		600		mA
SVR	Supply voltage rejection	V _I = V _{O(NOM)} +0.25 V ±	f = 1 kHz	60		dB
		V _{RIPPLE} = 0.1 V, I _O = 50 mA V _{O(NOM)} < 2.5 V, V _I = 2.55 V	f = 10 kHz	50		
I _{O(PK)}	Peak output current	V _O ≥ V _{O(NOM)} - 5%	300	550		mA
V _{INH}	Inhibit input logic low	V _I = 2.5 V to 6 V, T _J = -40 to 125 °C			0.4	V
	Inhibit input logic high		1.2			
I _{INH}	Inhibit input current	V _{INH} = 0.4 V, V _I = 6 V		±1		nA
eN	Output noise voltage	B _W = 10 Hz to 100 kHz, C _O = 1 μF		30		μV _{RMS}
t _{ON}	Turn-on time ⁽⁴⁾	C _{BYP} = 10 nF		100	250	μs
T _{SHDN}	Thermal shutdown	⁽⁵⁾		160		°C
C _O	Output capacitor	Capacitance ⁽⁶⁾	1		22	μF
		ESR	5		5000	mΩ

1. For V_{O(NOM)} < 2 V, V_I = 2.5 V
2. For V_{O(NOM)} = 1.25 V, V_I = 2.5 V
3. Dropout voltage is the input-to-output voltage difference at which the output voltage is 100 mV below its nominal value. This specification does not apply to input voltages below 2.5 V
4. Turn-on time is time measured between the enable input just exceeding V_{INH} high value and the output voltage just reaching 95% of its nominal value
5. Typical thermal protection hysteresis is 20 °C
6. The minimum capacitor value is 1 μF, anyway the LD3985 is still stable if the compensation capacitor has a 30% tolerance in all temperature range



6 Typical performance characteristics

$T_J = 25\text{ }^\circ\text{C}$, $V_I = V_{O(NOM)} + 0.5\text{ V}$, $C_I = C_O = 1\text{ }\mu\text{F}$, $C_{BYP} = 10\text{ nF}$, $I_O = 1\text{ mA}$, $V_{INH} = 1.4\text{ V}$, unless otherwise specified.

Figure 4. Output voltage vs. temperature ($V_O=1.35\text{ V}$)

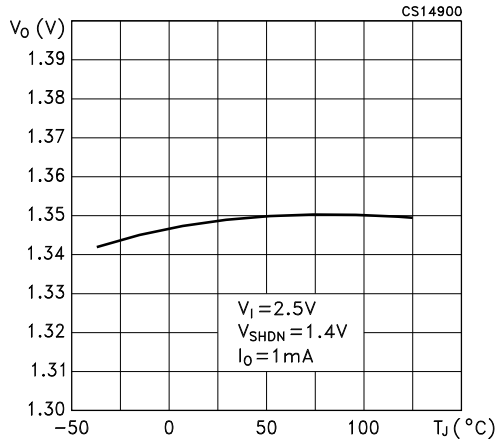

Figure 5. Output voltage vs. temperature ($V_O=2.7\text{ V}$)

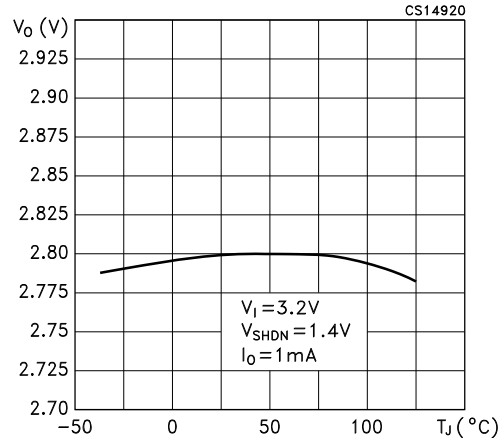

Figure 6. Output voltage vs. temperature ($V_O=3.3\text{ V}$)

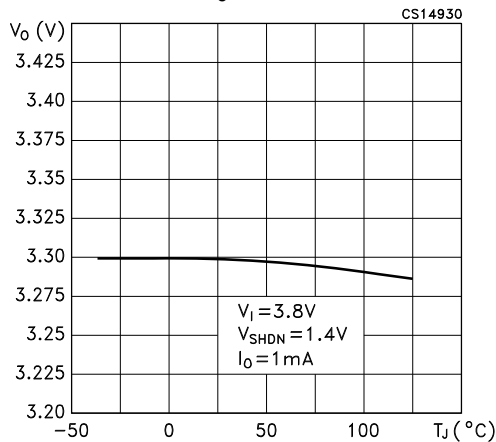

Figure 7. Shutdown voltage vs. temperature ($V_O=1.35\text{ V}$)

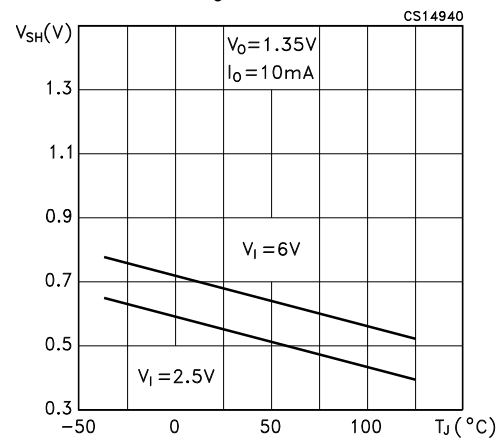

Figure 8. Shutdown voltage vs. temperature ($V_0=3.3\text{ V}$)

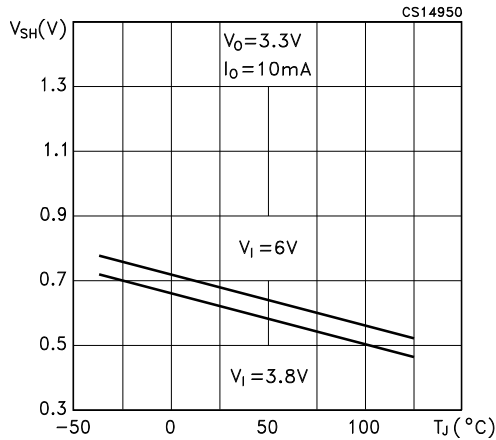

Figure 9. Line regulation vs. temperature ($V_0=1.35\text{ V}$)

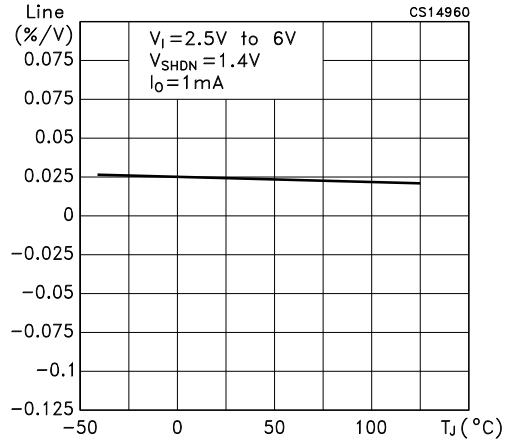

Figure 10. Line regulation vs. temperature ($V_0=2.7\text{ V}$)

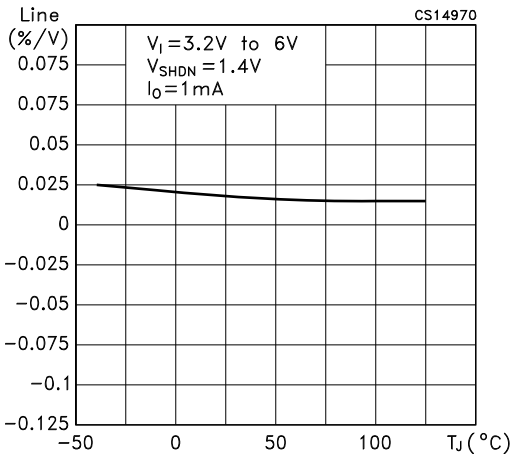

Figure 11. Line regulation vs. temperature ($V_0=3.3\text{ V}$)

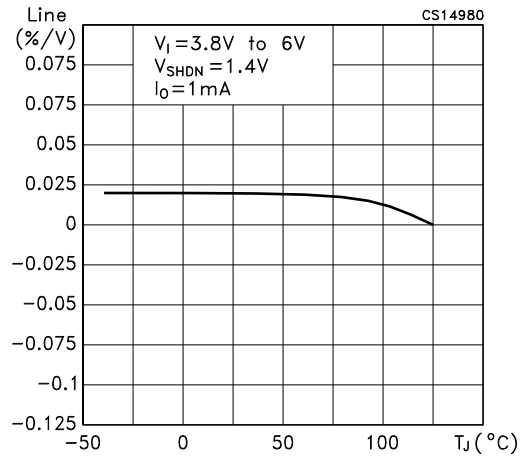

Figure 12. Load regulation vs. temperature ($V_0=1.35\text{ V}$)

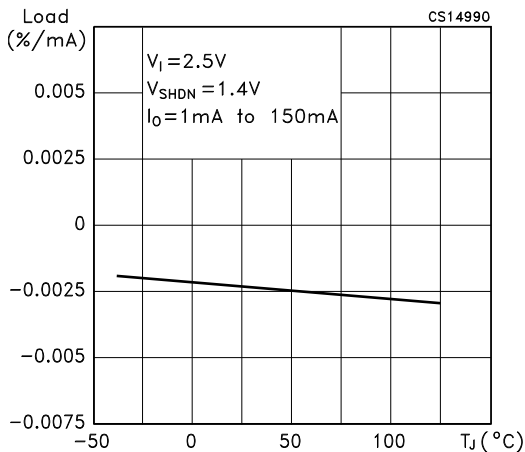

Figure 13. Load regulation vs. temperature ($V_0=2.7\text{ V}$)

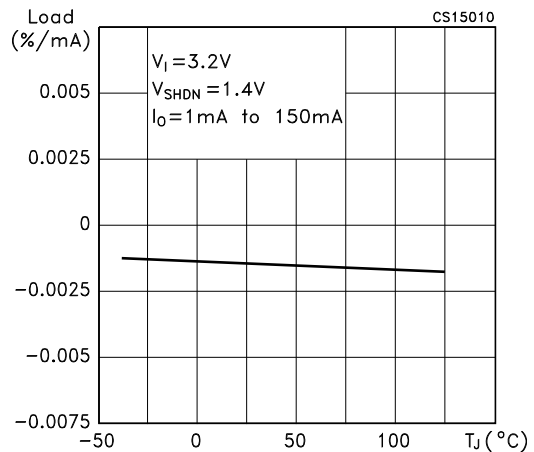

Figure 14. Load regulation vs. temperature
($V_0=3.3\text{ V}$)

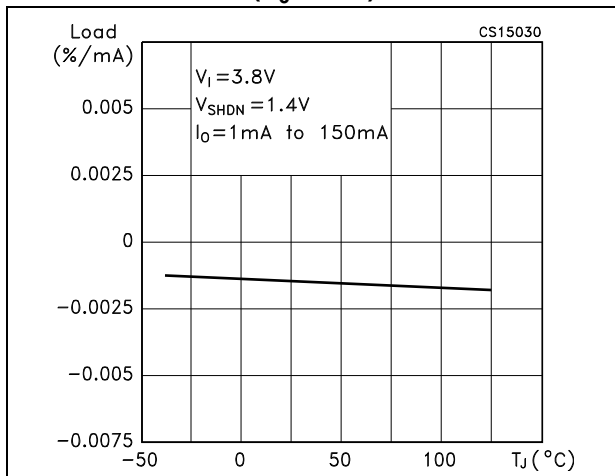

Figure 15. Quiescent current vs. temperature
($V_i=2.5\text{ V}$)

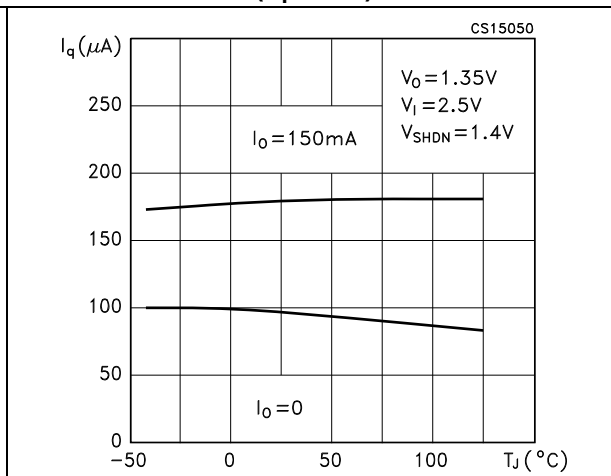

Figure 16. Quiescent current vs. temperature
($V_i=6\text{ V}$)

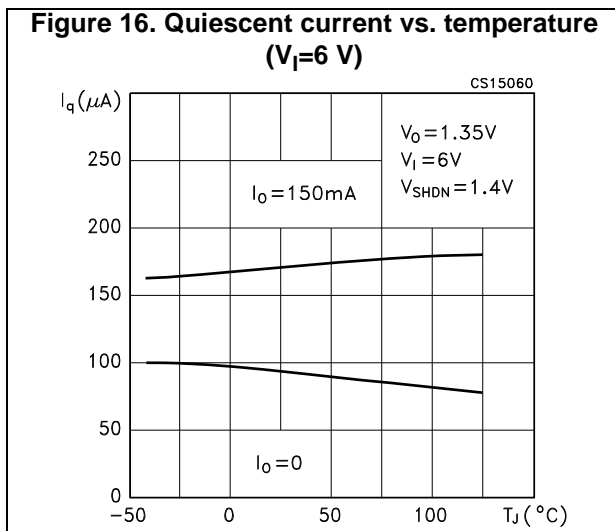

Figure 17. Quiescent current vs. load current

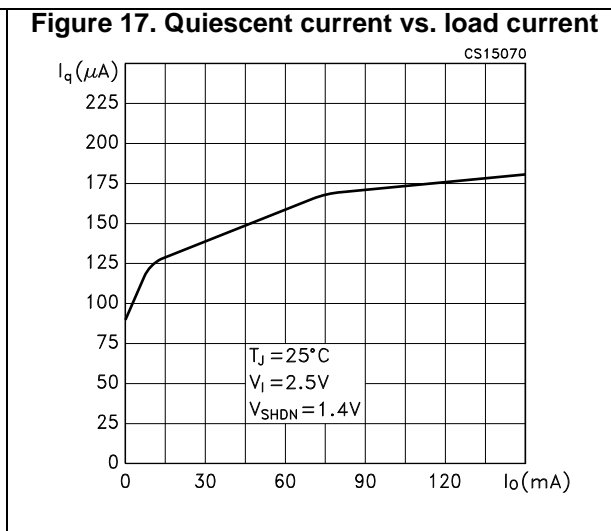

Figure 18. Supply voltage rejection vs. frequency

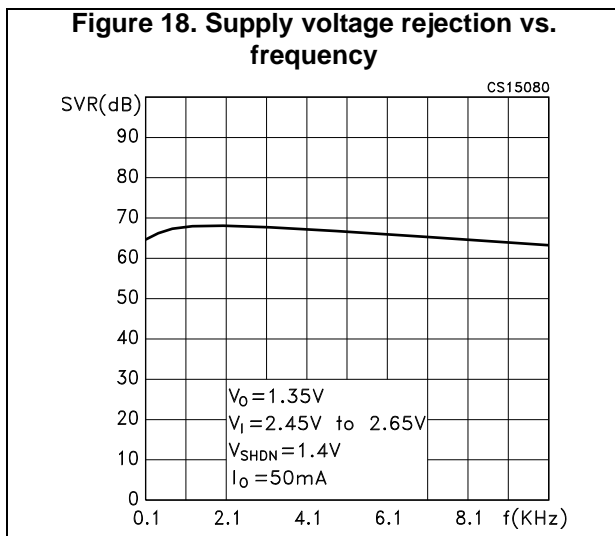

Figure 19. Load transient response

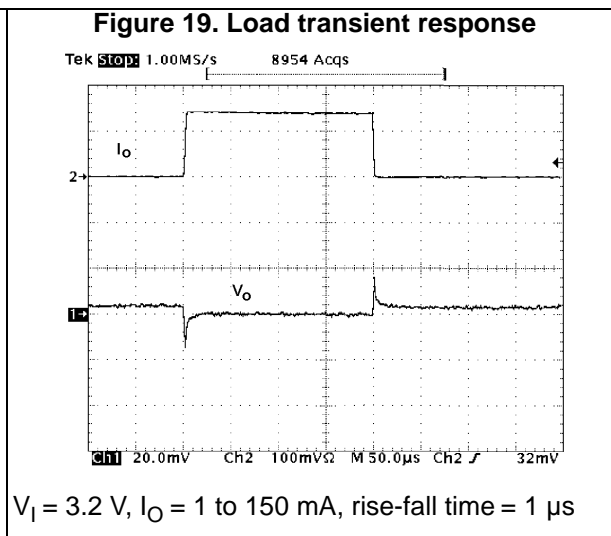
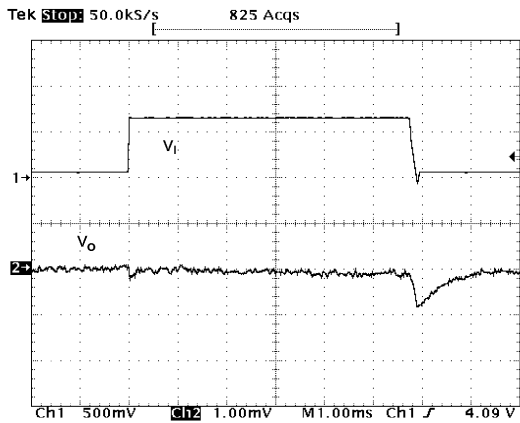
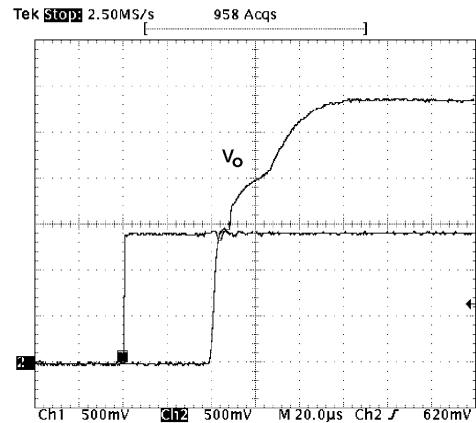

Figure 20. Line transient response



$V_I = 3.8\text{ V to }4.4\text{ V}$, $T_J = 25\text{ }^\circ\text{C}$, $I_O = 150\text{ mA}$, $C_I = C_O = 1\text{ }\mu\text{F}$ (X7R), $C_{BYP} = 10\text{ nF}$, rise-fall time = $1\text{ }\mu\text{s}$, $V_O = 2.7\text{ V}$

Figure 21. Startup



$V_I = 3.3\text{ V}$, $I_O = 1\text{ mA}$, $C_I = C_O = 1\text{ }\mu\text{F}$ (cer), $C_{BYP} = 10\text{ nF}$, $T_r = 20\text{ ns}$, $V_O = 2.8\text{ V}$

Figure 22. Turn-off

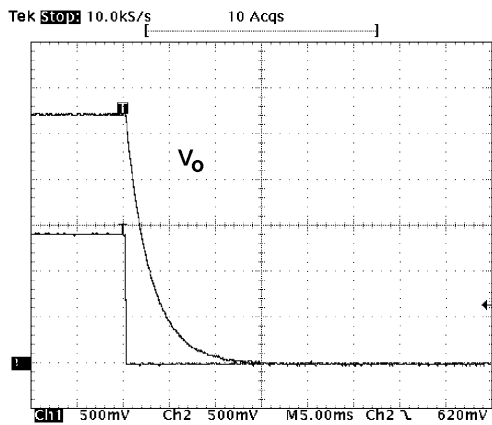

$V_I = 3.3\text{ V}$, $I_O = 1\text{ mA}$, $C_I = C_O = 1\text{ mF}$ (cer), $C_{BYP} = 10\text{ nF}$, $T_f = 20\text{ ns}$, $V_O = 2.8\text{ V}$

7 Package information

In order to meet environmental requirements, ST offers these devices in different grades of ECOPACK® packages, depending on their level of environmental compliance. ECOPACK® specifications, grade definitions and product status are available at: www.st.com. ECOPACK® is an ST trademark.

7.1 SOT23-5L package information

Figure 23. SOT23-5L package outline

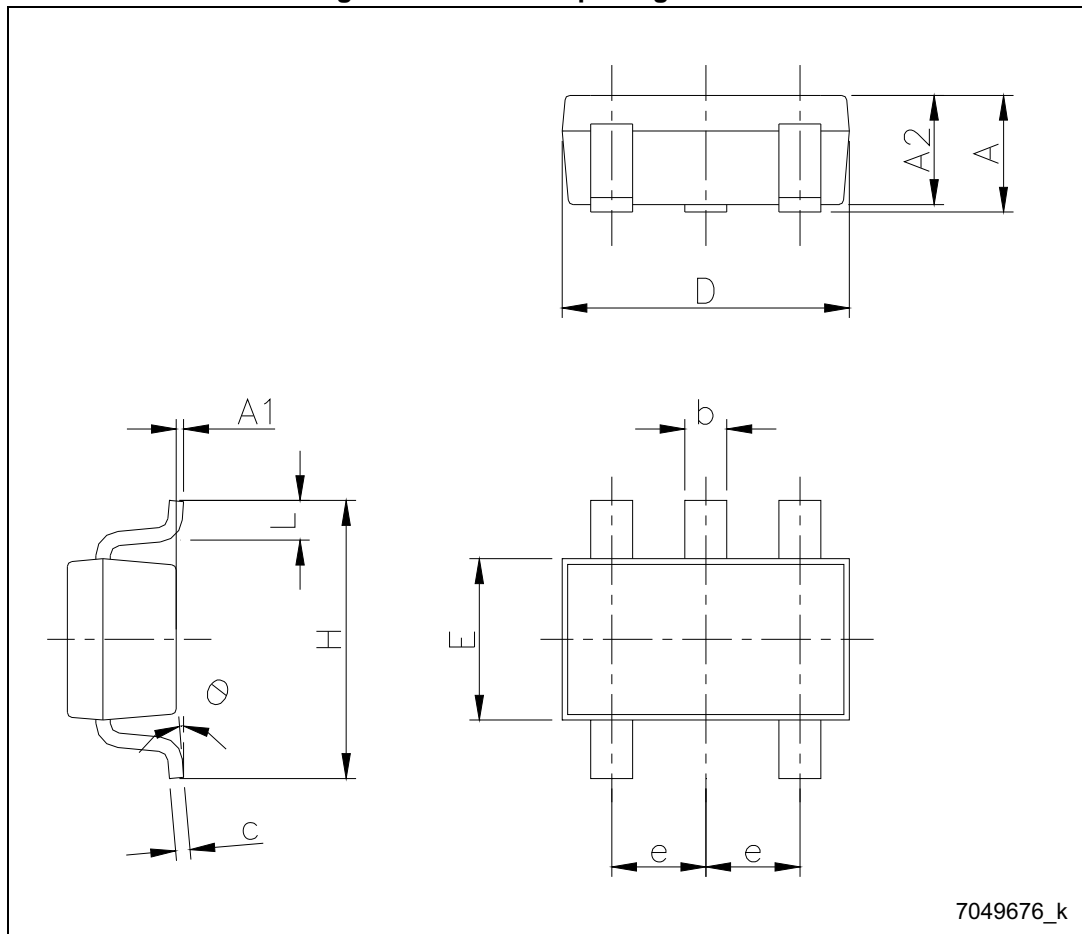
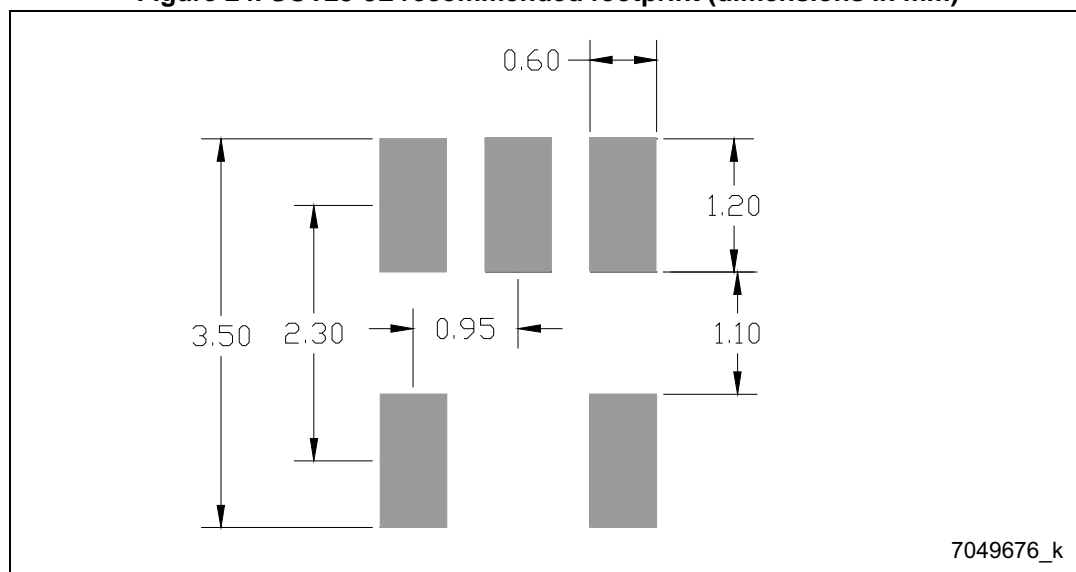

Table 5. SOT23-5L package mechanical data

Dim.	mm		
	Min.	Typ.	Max.
A	0.90		1.45
A1	0		0.15
A2	0.90		1.30
b	0.30		0.50
c	2.09		0.20
D		2.95	
E		1.60	
e		0.95	
H		2.80	
L	0.30		0.60
θ	0		8

Figure 24. SOT23-5L recommended footprint (dimensions in mm)



7.2 SOT23-5L packing information

Figure 25. SOT23-5L tape and reel outline

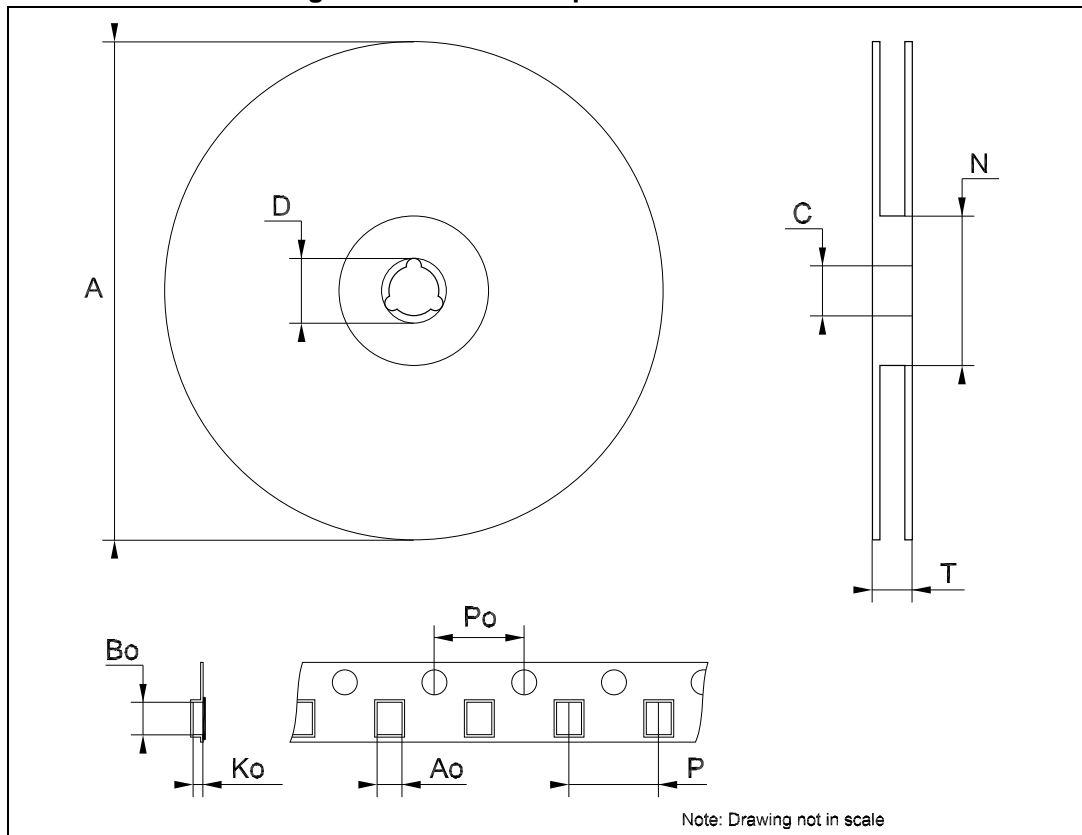

Table 6. SOT23-5L tape and reel mechanical data

Dim.	mm		
	Min.	Typ.	Max.
A			180
C	12.8	13.0	13.2
D	20.2		
N	60		
T			14.4
Ao	3.13	3.23	3.33
Bo	3.07	3.17	3.27
Ko	1.27	1.37	1.47
Po	3.9	4.0	4.1
P	3.9	4.0	4.1

8 Ordering information

Table 7. Ordering information

Order code	Output voltage
LD3985M122R	1.22 V
LD3985M18R	1.8 V
LD3985M25R	2.5 V
LD3985M27R	2.7 V
LD3985M28R	2.8 V
LD3985M29R	2.9 V
LD3985M30R	3.0 V
LD3985M33R	3.3 V
LD3985M47R	4.7 V

9 Revision history

Table 8. Document revision history

Date	Revision	Changes
07-May-2004	6	Part number status changed on table 3.
05-Oct-2004	7	t_{ON} values are changed on table 5.
27-Oct-2004	8	Order codes changed - table 3.
17-Mar-2005	9	Improved drawing quality for figures 19 - 20 - 21 - 22.
10-Apr-2007	10	Order codes updated.
08-Jun-2007	11	Order code change.
20-Dec-2007	12	Modified: <i>Table 1, Table 12</i> , mechanical data for Flip-chip.
02-Dec-2008	13	Modified: <i>Table 6 on page 14</i> and <i>Figure 23 on page 17</i> .
03-Jan-2011	14	Modified: <i>Features on page 1</i> and <i>Table 12 on page 20</i> .
08-Jan-2014	15	Part number LD3985XX changed to LD3985. Modified title in cover page. Updated the description and <i>Section 7: Package mechanical data</i> . Added <i>Section 8: Packaging mechanical data</i> . Minor text changes.
20-Jul-2017	16	Removed Flip Chip (1.57x1.22) and TSOT23-5L package information. Removed device summary table. Updated the whole document accordingly.

IMPORTANT NOTICE – PLEASE READ CAREFULLY

STMicroelectronics NV and its subsidiaries ("ST") reserve the right to make changes, corrections, enhancements, modifications, and improvements to ST products and/or to this document at any time without notice. Purchasers should obtain the latest relevant information on ST products before placing orders. ST products are sold pursuant to ST's terms and conditions of sale in place at the time of order acknowledgement.

Purchasers are solely responsible for the choice, selection, and use of ST products and ST assumes no liability for application assistance or the design of Purchasers' products.

No license, express or implied, to any intellectual property right is granted by ST herein.

Resale of ST products with provisions different from the information set forth herein shall void any warranty granted by ST for such product.



ST and the ST logo are trademarks of ST. All other product or service names are the property of their respective owners.

Information in this document supersedes and replaces information previously supplied in any prior versions of this document.

© 2017 STMicroelectronics – All rights reserved

Looking for pricing, stock, or lifecycle information?

Click below to explore more details on WIN SOURCE:

-  [View LD3985J18R](#) on WIN SOURCE
-  [STMicroelectronics](#) Information

Optimize Your Supply Chain with WIN SOURCE Solutions

-  Global Sourcing Solution
-  Obsolete Management
-  Cost Control Management
-  Shortage Management
-  Alternative Solution
-  Excess Inventory Management