



**THE DATASHEET OF
MIC2211-JPBML-TR**



General Description

The MIC2211 is a dual μ Cap low dropout regulator. The first regulator is capable of sourcing 150mA, while the second regulator can source up to 300mA.

Ideal for battery operated applications, the MIC2211 offers 1% accuracy, extremely low dropout voltage (80mV @ 100mA), and extremely low ground current (only 48 μ A total). Equipped with TTL logic compatible enable pins, the MIC2211 can be put into a zero-off-mode current state, drawing no current when disabled. Separate enable pins allow individual control of each output voltage.

The MIC2211 is a μ Cap design, operating with very small ceramic output capacitors for stability, reducing required board space and component cost.

The MIC2211 is available in fixed output voltages in the 10-pin 3mm \times 3mm MLF™ leadless package.

Features

- Input voltage range: 2.25V to 5.5V
- Stable with ceramic output capacitor
- 2 LDO outputs:
 - Output 1 - 150mA output current
 - Output 2 - 300mA output current
- Low dropout voltage of 80mV @ 100mA
- **Ultra-low quiescent current of 48 μ A total (24 μ A/LDO)**
- High output accuracy:
 - +1.0% initial accuracy
 - +2.0% over temperature
- Thermal shutdown protection
- Current limit protection
- **Tiny 10-pin 3mm \times 3mm MLF™ package**

Applications

- Cellular phones
- Wireless modems
- PDAs

Typical Application



MIC2211 Typical Cell Phone Application

Ordering Information

Part Number			Voltage* (Vo1/Vo2)	Junction Temp. Range	Package
Full	Manufacturing	Pb-FREE			
MIC2211-1.5/1.8BML	MIC2211-FGBML	MIC2211-FGYML	1.5V/1.8V	-40°C to +125°C	10-Pin 3x3 MLF™
MIC2211-1.5/2.8BML	MIC2211-FMBML	MIC2211-FMYML	1.5V/2.8V	-40°C to +125°C	10-Pin 3x3 MLF™
MIC2211-1.5/2.85BML	MIC2211-FNBML	MIC2211-FNYML	1.5V/2.85V	-40°C to +125°C	10-Pin 3x3 MLF™
MIC2211-1.5/2.9BML	MIC2211-FOBML	MIC2211-FOYML	15V/2.9V	-40°C to +125°C	10-Pin 3x3 MLF™
MIC2211-1.5/3.1BML	MIC2211-FQBML	MIC2211-FQYML	1.5V/3.1V	-40°C to +125°C	10-Pin 3x3 MLF™
MIC2211-1.6/2.8BML	MIC2211-WMBML	MIC2211-WMYML	1.6V/2.8V	-40°C to +125°C	10-Pin 3x3 MLF™
MIC2211-1.6/2.9BML	MIC2211-WOBML	MIC2211-WOYML	1.6V/2.9V	-40°C to +125°C	10-Pin 3x3 MLF™
MIC2211-1.6/3.3BML	MIC2211-WSBML	MIC2211-WSYML	1.6V/3.3	-40°C to +125°C	10-Pin 3x3 MLF™
MIC2211-1.8/2.5BML	MIC2211-GJBML	MIC2211-GJYML	1.8V/2.5V	-40°C to +125°C	10-Pin 3x3 MLF™
MIC2211-1.8/2.6BML	MIC2211-GKBML	MIC2211-GKYML	1.8V/2.6V	-40°C to +125°C	10-Pin 3x3 MLF™
MIC2211-1.8/2.8BML	MIC2211-GMBML	MIC2211-GMYML	1.8V/2.8V	-40°C to +125°C	10-Pin 3x3 MLF™
MIC2211-1.8/2.9BML	MIC2211-GOBML	MIC2211-GOYML	1.8V/2.9V	-40°C to +125°C	10-Pin 3x3 MLF™
MIC2211-1.8/3.0BML	MIC2211-GPBML	MIC2211-GPYML	1.8V/3.0V	-40°C to +125°C	10-Pin 3x3 MLF™
MIC2211-1.8/3.3BML	MIC2211-GSBML	MIC2211-GSYML	1.8V/3.3V	-40°C to +125°C	10-Pin 3x3 MLF™
MIC2211-1.9/2.8BML	MIC2211-YMBML	MIC2211-YMYML	1.9V/2.8V	-40°C to +125°C	10-Pin 3x3 MLF™
MIC2211-2.0/3.0BML	MIC2211-HPBML	MIC2211-HPYML	2.0V/3.0V	-40°C to +125°C	10-Pin 3x3 MLF™
MIC2211-2.5/1.8BML	MIC2211-JGBML	MIC2211-JGYML	2.5V/1.8V	-40°C to +125°C	10-Pin 3x3 MLF™
MIC2211-2.5/1.9BML	MIC2211-JYBML	MIC2211-JYYML	2.5V/1.9V	-40°C to +125°C	10-Pin 3x3 MLF™
MIC2211-2.5/2.8BML	MIC2211-JMBML	MIC2211-JMYML	2.5V/2.8V	-40°C to +125°C	10-Pin 3x3 MLF™
MIC2211-2.5/3.0BML	MIC2211-JPBML	MIC2211-JPYML	2.5V/3.0V	-40°C to +125°C	10-Pin 3x3 MLF™
MIC2211-2.5/3.3BML	MIC2211-JSBML	MIC2211-JSYML	2.5V/3.3V	-40°C to +125°C	10-Pin 3x3 MLF™
MIC2211-2.6/1.8BML		MIC2211-KGYML	2.6V/1.8V	-40°C to +125°C	10-Pin 3x3 MLF™
MIC2211-2.6/2.85BML		MIC2211-KNYML	2.6V/1.85V	-40°C to +125°C	10-Pin 3x3 MLF™
MIC2211-2.6/3.0BML	MIC2211-KPBML	MIC2211-KPYML	2.6V/3.0V	-40°C to +125°C	10-Pin 3x3 MLF™
MIC2211-2.7/1.8BML	MIC2211-LGBML	MIC2211-LGYML	2.7V/1.8V	-40°C to +125°C	10-Pin 3x3 MLF™
MIC2211-2.7/3.0BML	MIC2211-LPBML	MIC2211-LPYML	2.7V/3.0V	-40°C to +125°C	10-Pin 3x3 MLF™
MIC2211-2.8/1.5BML	MIC2211-MFBML	MIC2211-MFYML	2.8V/1.5V	-40°C to +125°C	10-Pin 3x3 MLF™
MIC2211-2.8/1.6BML	MIC2211-MWBML	MIC2211-MWYML	2.8V/1.6V	-40°C to +125°C	10-Pin 3x3 MLF™
MIC2211-2.8/1.8BML	MIC2211-MGBML	MIC2211-MGYML	2.8V/1.8V	-40°C to +125°C	10-Pin 3x3 MLF™
MIC2211-2.8/2.5BML	MIC2211-MJBML	MIC2211-MJYML	2.8V/2.5V	-40°C to +125°C	10-Pin 3x3 MLF™
MIC2211-2.8/2.8BML	MIC2211-MMBML	MIC2211-MMYML	2.8V/2.8V	-40°C to +125°C	10-Pin 3x3 MLF™
MIC2211-2.8/3.0BML	MIC2211-MPBML	MIC2211-MPYML	2.8V/3.0V	-40°C to +125°C	10-Pin 3x3 MLF™
MIC2211-2.8/3.3BML	MIC2211-MSBML	MIC2211-MSYML	2.8V/3.3V	-40°C to +125°C	10-Pin 3x3 MLF™
MIC2211-2.85/2.85BML	MIC2211-NNBML	MIC2211-NNYML	2.85V/2.85V	-40°C to +125°C	10-Pin 3x3 MLF™
MIC2211-2.85/3.3BML	MIC2211-NSBML	MIC2211-NSYML	2.85V/3.3V	-40°C to +125°C	10-Pin 3x3 MLF™
MIC2211-2.9/1.5BML	MIC2211-OFMBL	MIC2211-OFYML	2.9V/1.5V	-40°C to +125°C	10-Pin 3x3 MLF™
MIC2211-2.9/2.9BML	MIC2211-OOBML	MIC2211-OOYML	2.9V/2.9V	-40°C to +125°C	10-Pin 3x3 MLF™
MIC2211-3.0/1.6BML	MIC2211-PWBML	MIC2211-PWYML	3.0V/1.6V	-40°C to +125°C	10-Pin 3x3 MLF™
MIC2211-3.0/2.7BML	MIC2211-PLBML	MIC2211-PLYML	3.0V/2.7V	-40°C to +125°C	10-Pin 3x3 MLF™
MIC2211-3.0/2.8BML	MIC2211-PMBML	MIC2211-PMYML	3.0V/2.8V	-40°C to +125°C	10-Pin 3x3 MLF™
MIC2211-3.0/2.85BML	MIC2211-PNBML	MIC2211-PNYML	3.0V/2.85V	-40°C to +125°C	10-Pin 3x3 MLF™
MIC2211-3.0/3.0BML	MIC2211-PPBML	MIC2211-PPYML	3.0V/3.0V	-40°C to +125°C	10-Pin 3x3 MLF™
MIC2211-3.0/3.3BML	MIC2211-PSBML	MIC2211-PSYML	3.0V/3.3V	-40°C to +125°C	10-Pin 3x3 MLF™
MIC2211-3.3/1.8BML	MIC2211-SGBML	MIC2211-SGYML	3.3V/1.8V	-40°C to +125°C	10-Pin 3x3 MLF™
MIC2211-3.3/2.8BML	MIC2211-SMBML	MIC2211-SMYML	3.3V/2.8V	-40°C to +125°C	10-Pin 3x3 MLF™
MIC2211-3.3/3.3BML	MIC2211-SSBML	MIC2211-SSYML	3.3V/3.3V	-40°C to +125°C	10-Pin 3x3 MLF™
MIC2211-3.6/3.6BML	MIC2211-VVBML	MIC2211-VVYML	3.6V/3.6V	-40°C to +125°C	10-Pin 3x3 MLF™
MIC2211-ADJ/ADJBML	MIC2211-AABML	MIC2211-AAYML	ADJ/ADJ	-40°C to +125°C	10-Pin 3x3 MLF™

*For other output voltage options, contact Micrel marketing.

Pin Configuration



**10-Pin 3mm × 3mm MLF™ (ML)
(Top View)**



**10-Pin 3mm × 3mm MLF™ (ML) Adjustable
(Top View)**

Voltage	Code
Adj.	A
1.5	F
1.6	W
1.8	G
1.85	D
1.9	Y
2.0	H
2.1	E
2.5	J
2.6	K
2.65	I
2.7	L
2.8	M
2.850	N
2.9	O
3.0	P
3.1	Q
3.2	R
3.3	S
3.4	T
3.5	U
3.6	V

Table 1. Voltage Codes

Pin Description

Pin Number	Pin Name	Pin Function
1	VIN	Supply input: (VIN1 and VIN2 are internally tied together.)
2	EN1	Enable input to regulator 1: Enables regulator 1 output. Active high input. High = on, low = off. Do not leave floating.
3	EN2	Enable input to regulator 2: Enables regulator 2 output. Active high input. High = on, low = off. Do not leave floating.
4	CBYP	Reference bypass: Connect external 0.01μF to GND to reduce output noise. May be left open.
5, 7, 8	NC	No connection.
6	GND	Ground: Connect externally to Exposed Pad.
9	VOUT2	Output of regulator 2: 300mA output current
10	VOUT1	Output of regulator 1: 150mA output current
EP	GND	Ground: Internally connected to the Exposed Pad. Connect externally to pin 6.

Absolute Maximum Rating⁽¹⁾

Supply Input Voltage (V_{IN})	0V to 7V
Enable Input Voltage (V_{EN})	0V to 7V
Power Dissipation (P_D)	Internally Limited ⁽³⁾
Junction Temperature	-40°C to +125°C
Storage Temperature (T_S)	-65°C to 150°C
Lead Temperature (soldering, 5 sec.)	260°C

Operating Ratings⁽²⁾

Supply Input Voltage (V_{IN})	2.25V to 5.5V
Enable Input Voltage (V_{EN})	0V to V_{IN}
Junction Temperature (T_J)	-40°C to +125°C
Package Thermal Resistance	
MLF™-10 (θ_{JA})	60°C/W

Electrical Characteristics⁽⁴⁾

$V_{IN} = V_{OUT} + 1.0V$ for higher output of the regulator pair; $C_{OUT} = 1.0\mu F$, $I_{OUT} = 100\mu A$; $T_J = 25^\circ C$, **bold** values indicate $-40^\circ C \leq T_J \leq +125^\circ C$, unless noted.

Parameter	Conditions	Min	Typ	Max	Units
Output Voltage Accuracy	Variation from nominal V_{OUT}	-1.0		+1.0	%
		-2.0		+2.0	%
Output Voltage Temp. Coefficient			40		ppm/C
Line Regulation ⁽⁵⁾	$V_{IN} = V_{OUT} + 1V$ to 5.5V	-0.3	0.02	0.3	%/V
Load Regulation	$I_{OUT} = 100\mu A$ to 150mA (Regulator 1 and 2)		0.2	1.0	%
	$I_{OUT} = 100\mu A$ to 300mA (Regulator 2)			1.5	%
Dropout Voltage ⁽⁶⁾	$I_{OUT} = 150mA$ (Regulator 1 and 2)		120	190	mV
	$I_{OUT} = 300mA$ (Regulator 2)		240	340	mV
Ground Pin Current	$I_{OUT1} = I_{OUT2} = 0\mu A$		48	65	μA
	$I_{OUT1} = 150mA$ & $I_{OUT2} = 300mA$		60	80	μA
Ground Pin Current in Shutdown	$V_{EN} \leq 0.4V$			2.0	μA
Ripple Rejection	$f = 1kHz$; $C_{OUT} = 1.0\mu F$ ceramic; $C_{BYP} = 10nF$		60		dB
	$f = 20kHz$; $C_{OUT} = 1.0\mu F$ ceramic; $C_{BYP} = 10nF$		40		dB
Current Limit	$V_{OUT} = 0V$ (Regulator 1)	150	280	460	mA
	$V_{OUT} = 0V$ (Regulator 2)	300	450	700	mA
Output Voltage Noise	$C_{OUT} = 1\mu F$, $C_{BYP} = 0.01\mu F$, 10Hz to 100kHz		30		μV_{rms}

Enable Input

Enable Input Voltage	Logic Low (Regulator Shutdown)			0.6	V
	Logic High (Regulator Enabled)	1.8			V
Enable Input Current	$V_{IL} < 0.6V$ (Regulator Shutdown)	-1	0.01	+1	μA
	$V_{IH} > 1.8V$ (Regulator Enabled)	-1	0.01	+1	μA

Notes:

- Exceeding the absolute maximum ratings may damage the device.
- The device is not guaranteed to work outside its operating ratings.
- The maximum allowable power dissipation of any T_A (ambient temperature) is $(P_{D(max)} = T_{J(max)} - T_A) / \theta_{JA}$. Exceeding the maximum allowable power dissipation will result in excessive die temperature, and the regulator will go into thermal shutdown.
- Specification for packaged product only.
- Minimum input for line regulation test is set to $V_{OUT} + 1V$ relative to the highest output voltage.
- Dropout voltage is defined as the input-to-output differential at which the output voltage drops 2% below its nominal value measured at 1V differential. For outputs below 2.25V, dropout voltage is the input-to-output voltage differential with the minimum input voltage 2.25V. Minimum input operating voltage is 2.25V.

Typical Characteristics

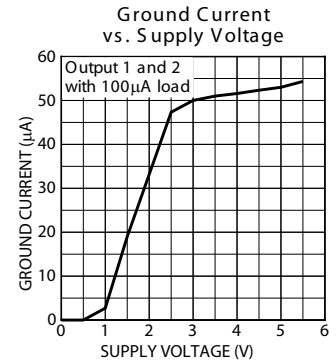
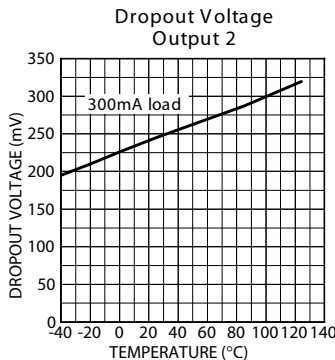
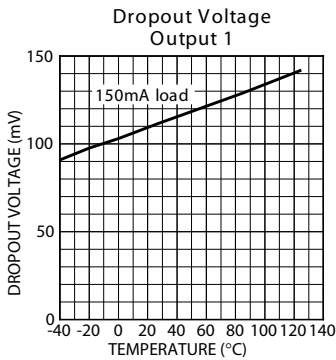

Typical Characteristics (cont.)

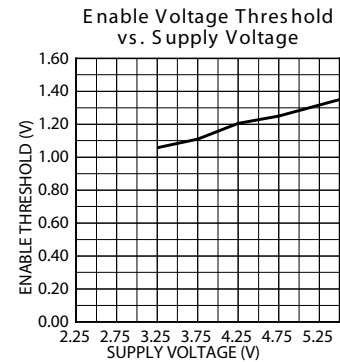
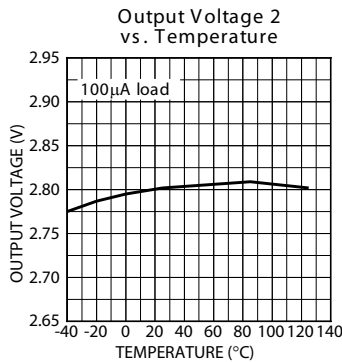
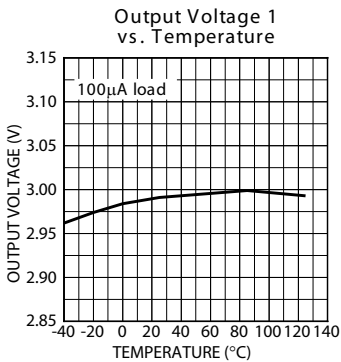

Functional Characteristics

Enable Characteristics



Load Transient Response (LDO 1)

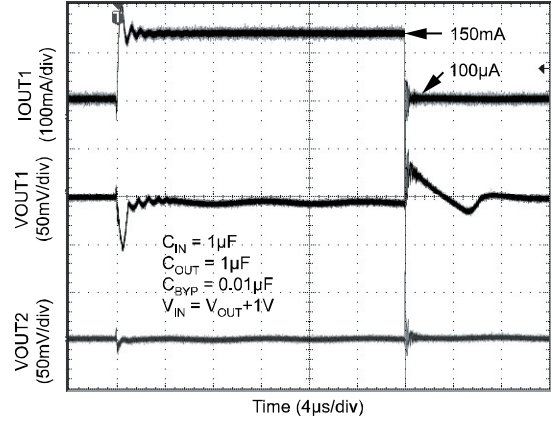

Load Transient Response (LDO 2)

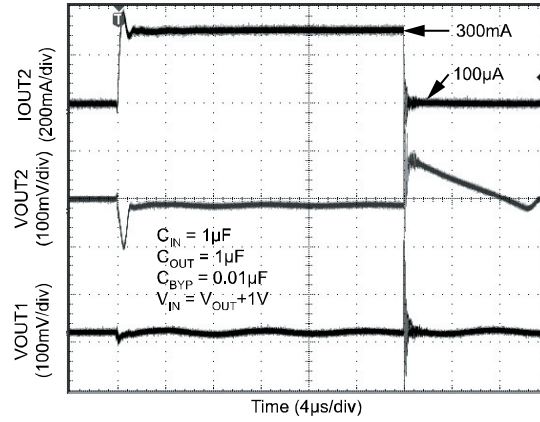

Functional Diagram



MIC2211 Fixed Voltage Block Diagram



MIC2211 Adjustable Voltage Block Diagram

Functional Description

The MIC2211 is a high performance, low quiescent current, power management IC consisting of two μ Cap low dropout regulators. The first regulator is capable of sourcing 150mA at output voltages from 1.25V to 5V; the second regulator is capable of sourcing 300mA of current at output voltages from 1.25V to 5V.

Enable 1 and 2

The enable inputs allow for logic control of both output voltages with individual enable inputs. The enable input is active high, requiring 1.8V for guaranteed operation. The enable input is CMOS logic and cannot be left floating.

Input Capacitor

Good bypassing is recommended from input to ground to help improve AC performance. A 1 μ F capacitor or greater located close to the IC is recommended.

Bypass Capacitor

The internal reference voltage of the MIC2211 can be bypassed with a capacitor to ground to reduce output noise and increase power supply rejection (PSRR). A quick-start feature allows for quick turn-on of the output voltage regardless of the size of the capacitor. The recommended nominal bypass capacitor is 0.01 μ F, but it can be increased without limit.

Output Capacitor

Each regulator output requires a 1 μ F ceramic output capacitor for stability. The output capacitor value can be increased to improve transient response, but performance has been optimized for a 1 μ F ceramic type output capacitor.

X7R/X5R dielectric-type ceramic capacitors are recommended because of their temperature performance. X7R-type capacitors change capacitance by 15% over their operating temperature range and are the most stable type of ceramic capacitors. Z5U and Y5V dielectric capacitors change value by as much as 50% and 60% respectively over their operating temperature ranges. To use a ceramic chip capacitor with Y5V dielectric, the value must be much higher than an X7R ceramic capacitor to ensure the same minimum capacitance over the equivalent operating temperature range.

Adjustable Regulator Design

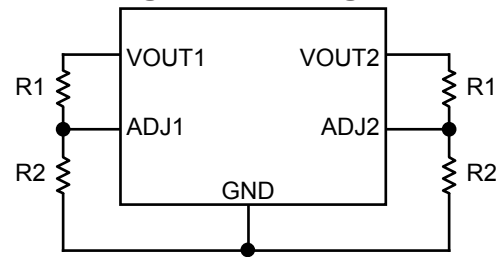

MIC2211 Adjustable Regulator Design

The MIC2211 allows the programming of the output voltages 1 and 2 anywhere between 1.25V and 5.5V, the maximum operating rating of the part. Two resistors are required for each output. Appropriate resistor values are required to prevent the low quiescent current performance being compromised. Resistor values recommended are between 100k Ω and 500k Ω .

The resistor values are calculated by:

$$R1 = R2 \left(\frac{V_{OUT}}{1.250} - 1 \right)$$

where V_{OUT} is the desired output voltage. Calculate separately for each output.

Package Information

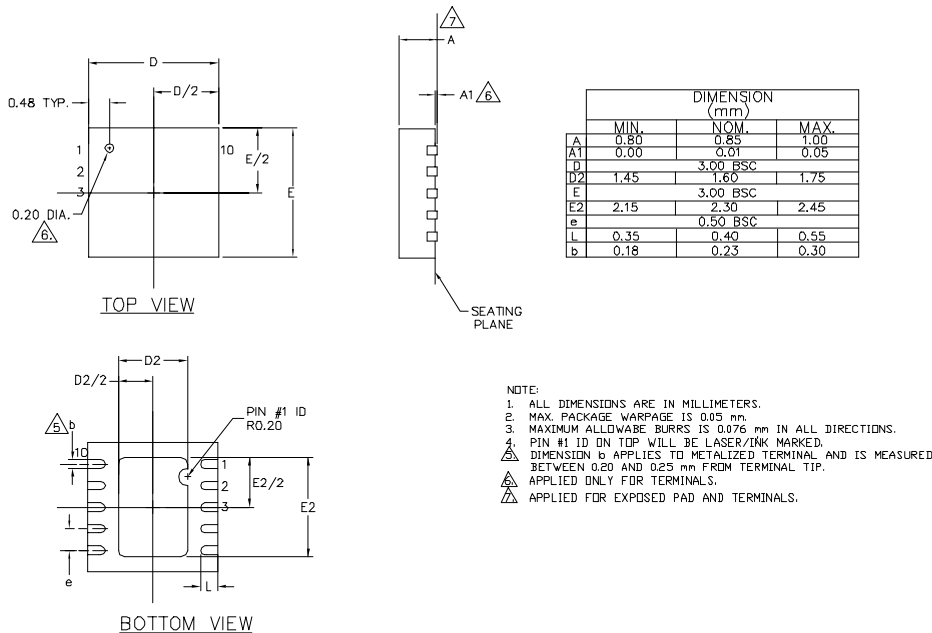

10-Pin MLF™ (ML)

MICREL INC. 2180 FORTUNE DRIVE SAN JOSE, CA 95131 USA
 TEL + 1 (408) 944-0800 FAX + 1 (408) 474-1000 WEB <http://www.micrel.com>

This information furnished by Micrel in this data sheet is believed to be accurate and reliable. However no responsibility is assumed by Micrel for its use. Micrel reserves the right to change circuitry and specifications at any time without notification to the customer.

Micrel Products are not designed or authorized for use as components in life support appliances, devices or systems where malfunction of a product can reasonably be expected to result in personal injury. Life support devices or systems are devices or systems that (a) are intended for surgical implant into the body or (b) support or sustain life, and whose failure to perform can be reasonably expected to result in a significant injury to the user. A Purchaser's use or sale of Micrel Products for use in life support appliances, devices or systems is a Purchaser's own risk and Purchaser agrees to fully indemnify Micrel for any damages resulting from such use or sale.

Looking for pricing, stock, or lifecycle information?

Click below to explore more details on WIN SOURCE:

- ⊖ [View MIC2211-JPBML-TR on WIN SOURCE](#)
- ⊖ [Microchip Technology](#) Information

Optimize Your Supply Chain with WIN SOURCE Solutions

- ✓ Global Sourcing Solution
- ✓ Obsolete Management
- ✓ Cost Control Management
- ✓ Shortage Management
- ✓ Alternative Solution
- ✓ Excess Inventory Management