



**THE DATASHEET OF  
MP6211DH-LF-P**



## DESCRIPTION

The MP6211/MP6212 single-channel Power Distribution Switch features internal current limiting to prevent damage to host devices due to faulty load conditions. The MP6211/MP6212 Analog switch has 90mΩ on-resistance and operates from 2.7V to 5.5V input. It is available with guaranteed current limits, making it ideal for load switching applications. The MP6211/MP6212 has built-in protection for both over current and increased thermal stress. For over current, the device will limit the current by changing to a constant current mode.

As the temperature increases as a result of short circuit, the device will shut off. The device will recover once the device temperature reduces to approx 120°C.

The MP6211/MP6212 is available in an 8-PIN MSOP and SOIC package with exposed pad.

## FEATURES

- 1A Continuous Current
- Accurate Current Limit
- 2.7V to 5.5V Supply Range
- 90uA Quiescent Current
- 90mΩ MOSFET
- Thermal-Shutdown Protection
- Under-Voltage Lockout
- 8ms FLAG Deglitch Time
- No FLAG Glitch During Power Up
- Reverse Current Blocking
- Active High & Active Low Options
- MSOP8E and SOIC8E package
- UL Recognized: E322138

## APPLICATIONS

- Smartphone and PDA
- Portable GPS Device
- Notebook PC
- Set-top-box
- Telecom and Network Systems
- USB Power Distribution

"MPS" and "The Future of Analog IC Technology" are Trademarks of Monolithic Power Systems, Inc.

## TYPICAL APPLICATION

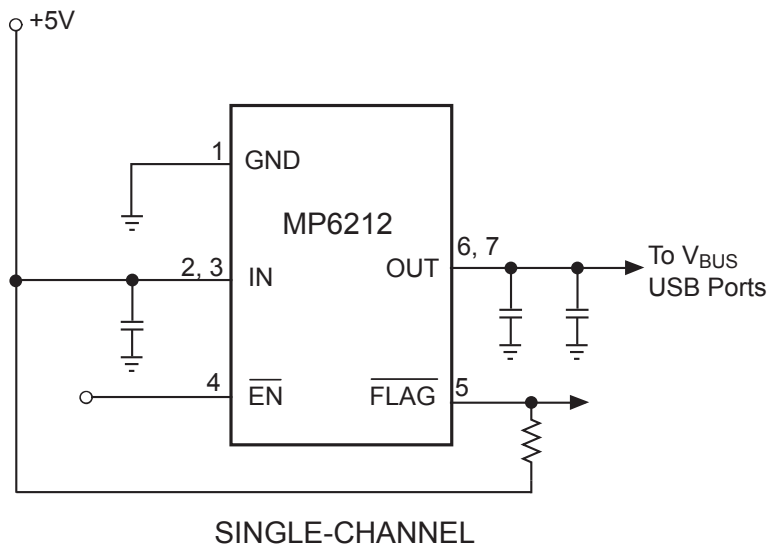

UL Recognized Component

### ORDERING INFORMATION

Part Number*	Enable	Switch	Maximum Continuous Load Current	Typical Short-Circuit Current @ T <sub>A</sub> =25°C	Package	Top Marking	Temperature
MP6211DN	Active High	Single	1.0A	1.5A	SOIC8E	6211D	-40°C to +85°C
MP6211DH	Active High	Single	1.0A	1.5A	MSOP8E		
MP6212DN	Active Low	Single	1.0A	1.5A	SOIC8E	6212D	
MP6212DH	Active Low	Single	1.0A	1.5A	MSOP8E		

\* For Tape & Reel, add suffix -Z (eg. MP6211\_MP6212DN-Z). For RoHS Compliant Packaging, add suffix -LF. (eg. MP6211\_MP6212DN-LF-Z)

### PACKAGE REFERENCE

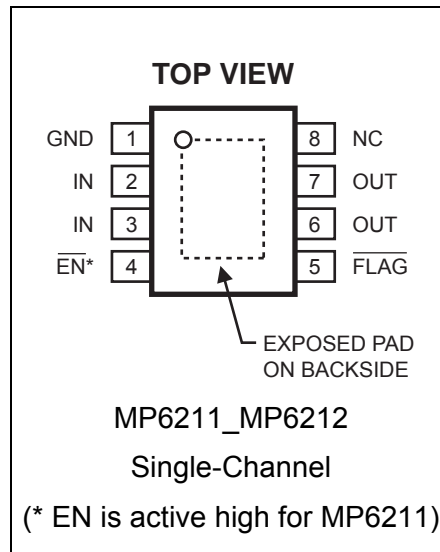

### ABSOLUTE MAXIMUM RATINGS <sup>(1)</sup>

IN .....	-0.3V to +6.0V
EN, FLAG, OUT to GND .....	-0.3V to +6.0V
Continuous Power Dissipation. (T <sub>A</sub> = +25°C) <sup>(2)</sup>	
SOIC8E .....	2.5W
MSOP8E .....	2.3W
Junction Temperature .....	150°C
Lead Temperature .....	260°C
Storage Temperature .....	-65°C to +150°C
Operating Temperature .....	-40°C to +85°C

### Thermal Resistance <sup>(3)</sup>      θ<sub>JA</sub>      θ<sub>JC</sub>

SOIC8E .....	50 .....	10... °C/W
MSOP8E .....	55 .....	12... °C/W

**Notes:**

- Exceeding these ratings may damage the device.
- The maximum allowable power dissipation is a function of the maximum junction temperature T<sub>J</sub> (MAX), the junction-to-ambient thermal resistance θ<sub>JA</sub>, and the ambient temperature T<sub>A</sub>. The maximum allowable continuous power dissipation at any ambient temperature is calculated by P<sub>D</sub> (MAX) = (T<sub>J</sub> (MAX)-T<sub>A</sub>)/θ<sub>JA</sub>. Exceeding the maximum allowable power dissipation will cause excessive die temperature, and the regulator will go into thermal shutdown. Internal thermal shutdown circuitry protects the device from permanent damage.
- Measured on JESD51-7 4-layer PCB.

## ELECTRICAL CHARACTERISTICS <sup>(4)</sup>

$V_{IN}=5V$ ,  $T_A=+25^{\circ}C$ , unless otherwise noted.

Parameter	Condition	Min	Typ	Max	Units
IN Voltage Range		2.7		5.5	V
Supply Current	Single Channel		90	120	$\mu A$
Shutdown Current	Device Disable, $V_{OUT}=\text{float}$ , $V_{IN}=5.5V$		1		$\mu A$
Off Switch Leakage	Device Disable, $V_{IN}=5.5V$		1		$\mu A$
Current Limit		1.1	1.5	2.2	A
Trip Current	Current Ramp (slew rate $\leq 100A/s$ ) on Output		1.7	2.4	A
Under-voltage Lockout	Rising Edge	1.95		2.65	V
Under-voltage Hysteresis			250		mV
FET On Resistance	$I_{OUT}=100mA$ ( $-40^{\circ}C \leq T_A \leq 85^{\circ}C$ )		90	130	m $\Omega$
EN Input Logic High Voltage		2			V
EN Input Logic Low Voltage				0.8	V
FLAG Output Logic Low Voltage	$I_{SINK}=5mA$			0.4	V
FLAG Output High Leakage Current	$V_{IN}=V_{FLAG}=5.5V$			1	$\mu A$
Thermal Shutdown			140		$^{\circ}C$
Thermal Shutdown Hysteresis			20		$^{\circ}C$
$V_{OUT}$ Rising Time, $T_r$ <sup>(5)</sup>	$V_{IN}=5.5V$ , $CL=1\mu F$ , $RL=5.5\Omega$		0.9		ms
	$V_{IN}=2.7V$ , $CL=1\mu F$ , $RL=5.5\Omega$		1.7		ms
$V_{OUT}$ Falling Time, $T_f$ <sup>(6)</sup>	$V_{IN}=5.5V$ , $CL=1\mu F$ , $RL=5.5\Omega$			0.5	ms
	$V_{IN}=2.7V$ , $CL=1\mu F$ , $RL=5.5\Omega$			0.5	ms
Turn On Time, $T_{on}$ <sup>(7)</sup>	$C_L=100\mu F$ , $RL=5.5\Omega$			3	ms
Turn Off Time, $T_{off}$ <sup>(8)</sup>	$C_L=100\mu F$ , $RL=5.5\Omega$			10	ms
FLAG Deglitch Time		4	8	15	ms
ENx Input Leakage			1		$\mu A$
Reverse Leakage Current	$OUT=5.5V$ , $IN=GND$		0.2		$\mu A$

### NOTES:

- 4) Production test at  $+25^{\circ}C$ . Specifications over the temperature range are guaranteed by design and characterization.
- 5) Measured from 10% to 90%.
- 6) Measured from 90% to 10%
- 7) Measured from (50%) EN signal to (90%) output signal.
- 8) Measured from (50%) EN signal to (10%) output signal.

## PIN FUNCTIONS

SOIC8 MSOP8E	Name	Description
1	GND Expose Pad	Ground. Connect exposed pad to GND plane for optimal thermal performance.
2, 3	IN	Input Voltage. Accepts 2.7V to 5.5V input.
4	$\overline{\text{EN}}$	Enable Input, Active Low: (MP6212), Active High: (MP6211)
5	$\overline{\text{FLAG}}$	IN-to-OUT Over-current, active-low output flag. Open-Drain.
6, 7	OUT	Power-Distribution Switch Output.
8	N/C	No Connect. Not internally connected.

## TYPICAL PERFORMANCE CHARACTERISTICS

$T_A = +25^\circ\text{C}$ , unless otherwise noted.

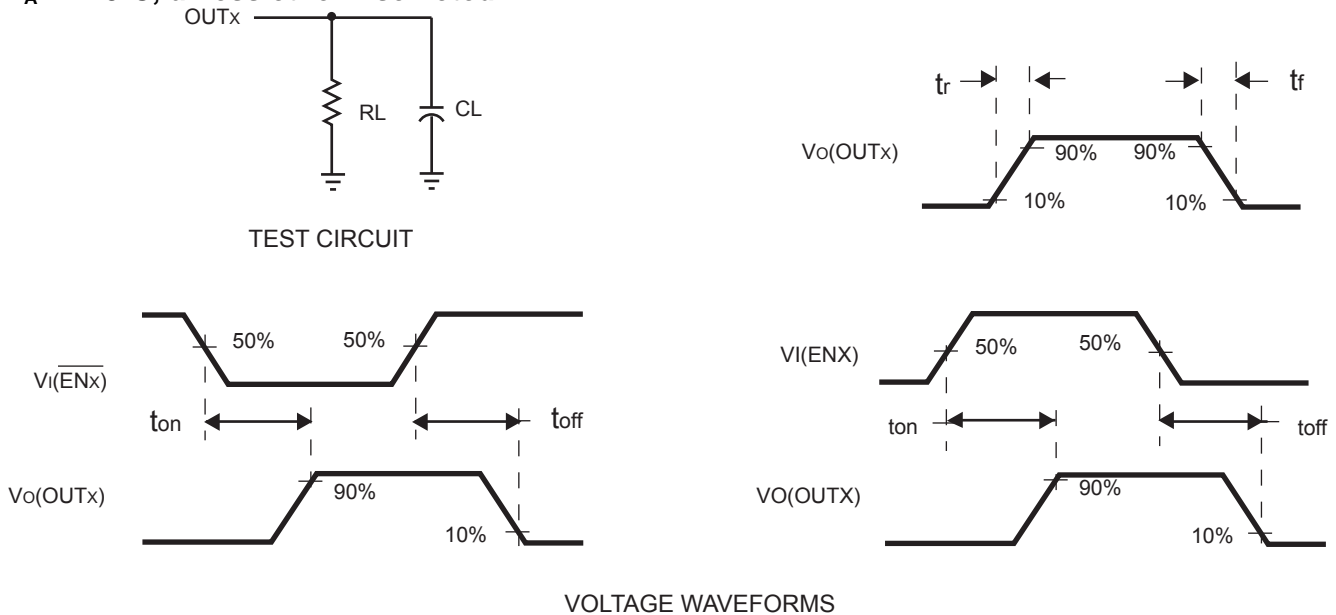

Figure 1—Test Circuit and Voltage Waveforms

## TYPICAL PERFORMANCE CHARACTERISTICS

$V_{IN}=5.5V$ ,  $C_L=2.2\mu F$ ,  $T_A = +25^\circ C$ , unless otherwise noted.

**Turn on Delay vs. Input Voltage**

$V_{EN}=5V$ ,  $R_L=5.5\Omega$

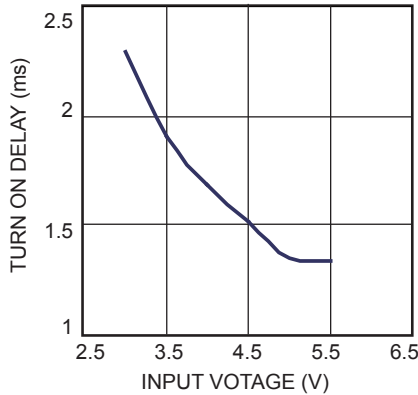

**Turn off Delay vs. Input Voltage**

$V_{EN}=5V$ ,  $R_L=5.5\Omega$

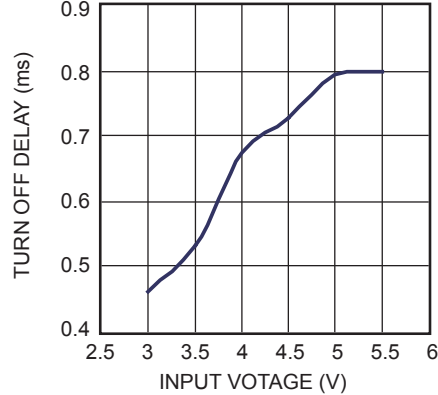

**Supply Current, Output Enabled vs. Input Voltage**

$V_{EN}=5V$

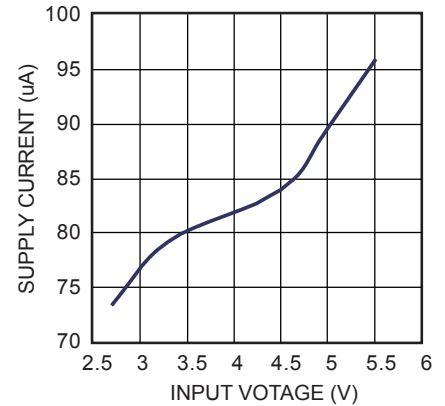

**Static Drain-Source On-State Resistance Variation vs. Ambient Temperature**

$V_{IN}=5V$ ,  $I_O=0.1A$

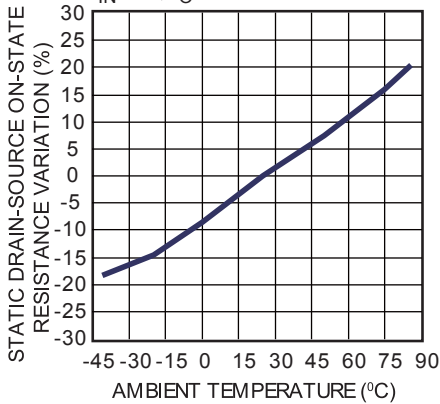

**Static Drain-Source On-State Resistance vs. Input Voltage**

$V_{EN}=5V$ ,  $I_{OUT}=1A$

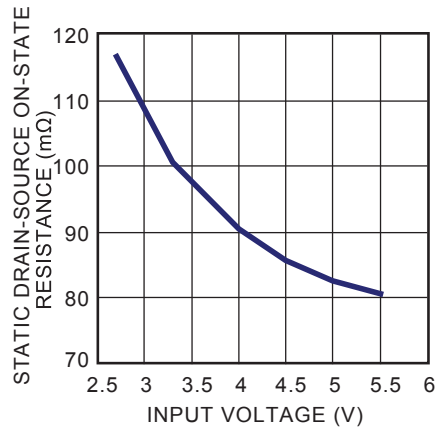

**Input to Output Voltage vs. Load Current**

$V_{EN}=5V$

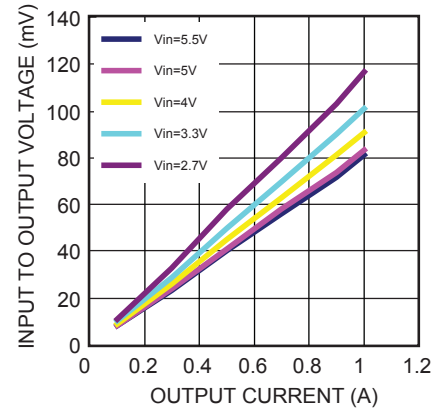

**Short Circuit Output Current vs. Input Voltage**

$V_{EN}=5V$ ,  $V_{IN}=5V$

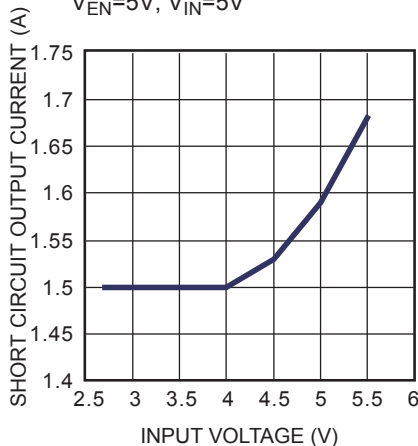

**Threshold Trip Current vs. Input Voltage**

$V_{EN}=5V$

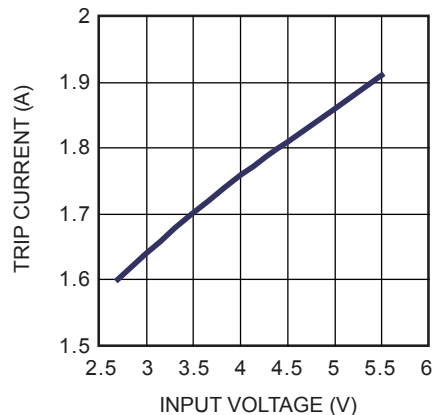

**Current Limit Response Time vs. Peak Current**

$V_{EN}=5V$

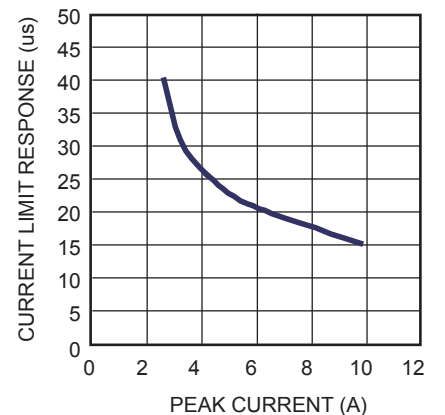

**TYPICAL PERFORMANCE CHARACTERISTICS (continued)**
 $V_{IN}=5.5V$ ,  $T_A = +25^{\circ}C$ , unless otherwise noted.

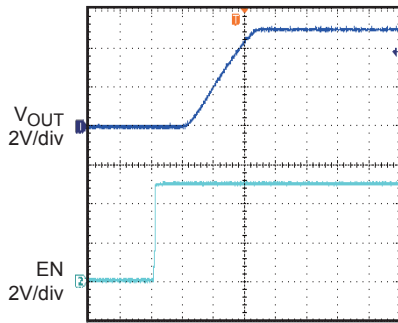
**Turn On Delay and Rise Time with 0.1 $\mu$ F Load**
 $V_{EN}=5V$ ,  $C_L=0.1\mu F$ 

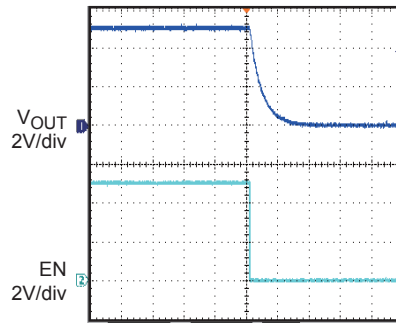
 400 $\mu$ s/div

**Turn Off Delay and Fall Time with 0.1 $\mu$ F Load**
 $V_{EN}=5V$ ,  $C_L=0.1\mu F$ 

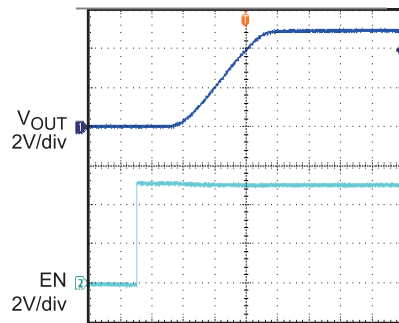
1s/div

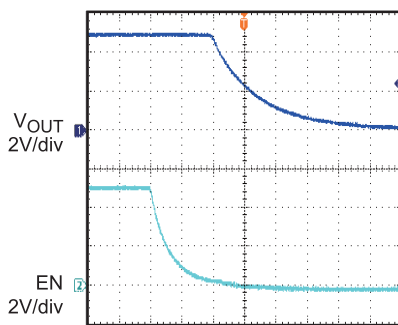
**Turn on Delay and Rise Time with 1 $\mu$ F Load**
 $V_{EN}=5V$ ,  $R_L=5.5\Omega$ ,  $C_L=1\mu F$ 

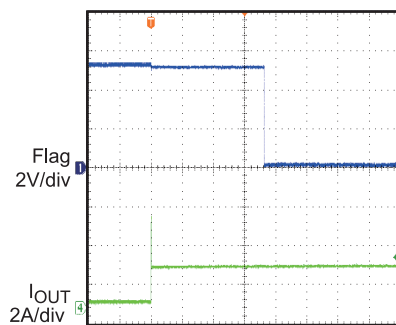
 400 $\mu$ s/div

**Turn off Delay and Fall Time with 1 $\mu$ F Load**
 $V_{EN}=5V$ ,  $R_L=5.5\Omega$ ,  $C_L=1\mu F$ 

 400 $\mu$ s/div

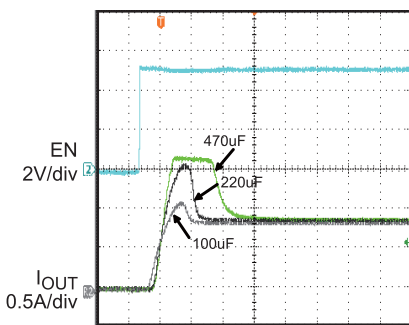
**1 $\Omega$  Load Connected to Enabled Device**
 $V_{EN}=5V$ ,  $C_L=1\mu F$ 

2ms/div

**Inrush Current with Different Load Capacitance**
 $V_{EN}=5V$ ,  $R_L=5.5\Omega$ , Start up by EN

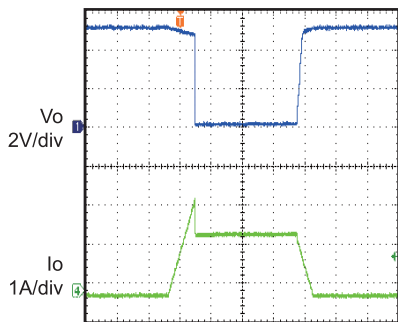
1ms/div

**Threshold Trip Current with Ramped Load on Enabled Device**
 $V_{EN}=5V$ ,  $C_L=1\mu F$ 

4ms/div

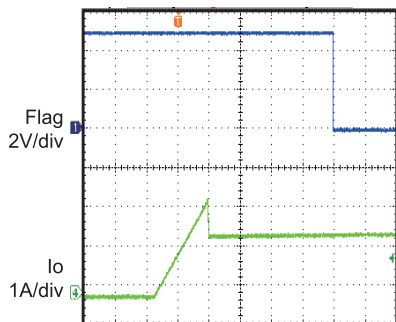
**Ramped Load on Enabled Device**
 $V_{EN}=5V$ ,  $C_L=1\mu F$ 

2ms/div

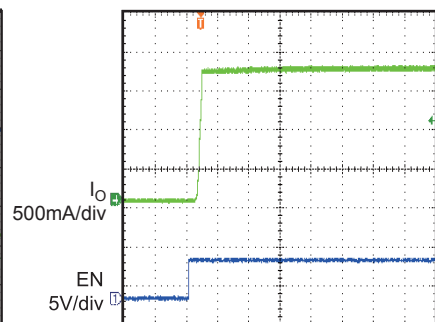
**Short Circuit Current, Device Enabled into Short**
 $V_{EN}=5V$ ,  $C_L=1\mu F$ 

2ms/div

FUNCTION BLOCK DIAGRAM

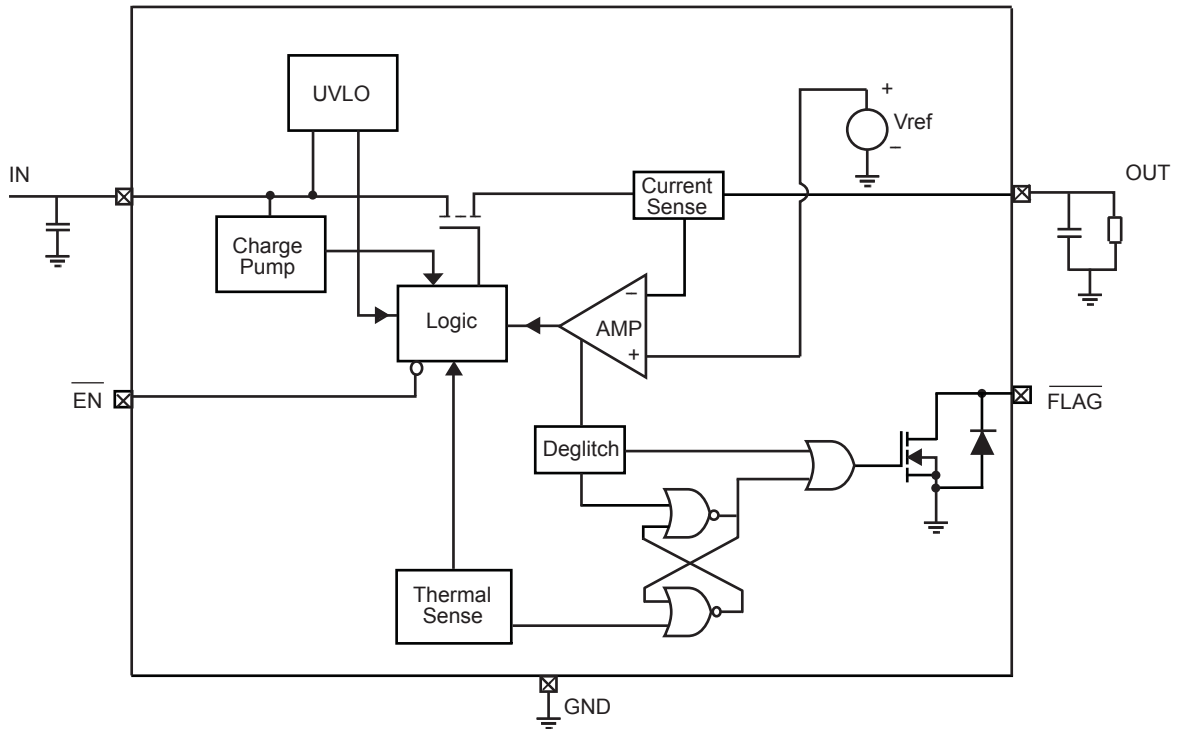

Figure 2—Functional Block Diagram

## DETAILED DESCRIPTION

### Over Current

When the load exceeds trip current (minimum threshold current triggering constant-current mode) or a short is present, MP6211/MP6212 switches into to a constant-current mode (current limit value). MP6211/MP6212 will be shutdown only if the overcurrent condition stays long enough to trigger thermal protection.

Trigger overcurrent protection for different overload conditions occurring in applications:

- 1) The output has been shorted or overloaded before the device is enabled or input applied. MP MP6211/MP6212 detects the short or overload and immediately switches into a constant-current mode.
- 2) A short or an overload occurs after the device is enabled. After the current-limit circuit has been tripped (reached the trip current threshold), the device switches into constant-current mode. However, high current may flow for a short period of time before the current-limit circuit can react.
- 3) Output current has been gradually increased beyond the recommended operating current. The load current rises until the trip current threshold is reached or until the thermal limit of the device is exceeded. The MP6211/MP6212 is capable of delivering current up to the trip current threshold without damaging the device. Once the trip threshold has been reached, the device switches into its constant-current mode.

### Flag Response

The FLAG pin is an open drain configuration. This FAULT will report a fail mode after an 8ms deglitch timeout. This is used to ensure that no false fault signals are reported. This internal deglitch circuit eliminates the need for extend components. The FLAG pin is not deglitched during an over temp. or a voltage lockout.

### Thermal Protection

The purpose of thermal protection is to prevent damage in the IC by allowing excessive current to flow and heating the junction. The die temp. is internally monitored until the thermal limit is reached. Once this temp. is reached, the switch will turn off and allow the chip to cool. The switch has a built-in hysteresis.

### Under-voltage Lockout (UVLO)

This circuit is used to monitor the input voltage to ensure that the MP6211/6212 is operating correctly. This UVLO circuit also ensures that there is no operation until the input voltage reaches the minimum spec.

### Enable

The logic pin disables the chip to reduce the supply current. The device will operate once the enable signal reaches the appropriate level. The input is compatible with both COMS and TTL.

## APPLICATION INFORMATION

### Power-Supply Considerations

Over 10 $\mu$ F capacitor between IN and GND is recommended. This precaution reduces power-supply transients that may cause ringing on the input and improves the immunity of the device to short-circuit transients.

In order to achieve smaller output load transient ripple, placing a high-value electrolytic capacitor on the output pin(s) is recommended when the load is heavy.

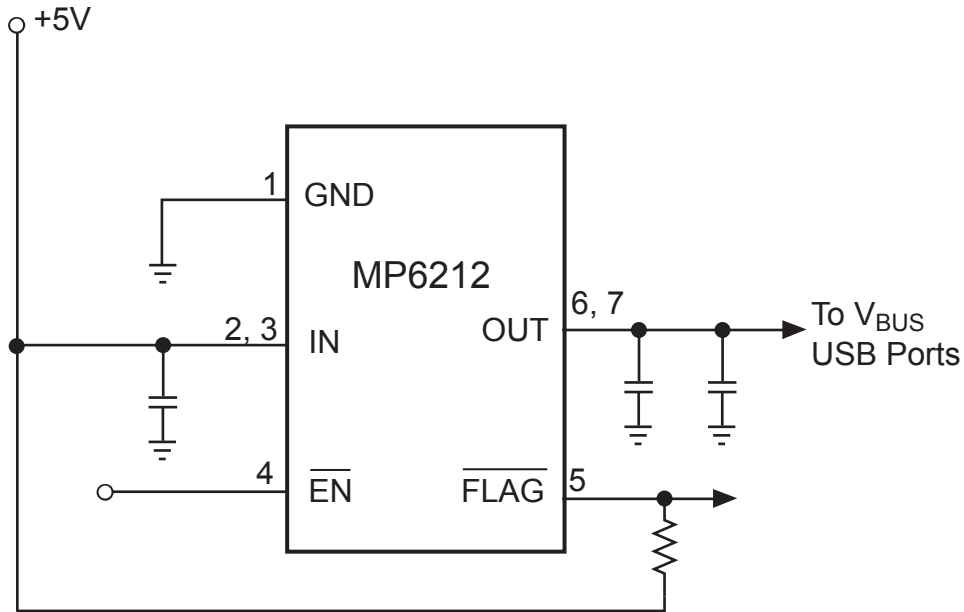

SINGLE-CHANNEL

Figure 3—Application Circuit

## PACKAGE INFORMATION

### MSOP8E (EXPOSED PAD)

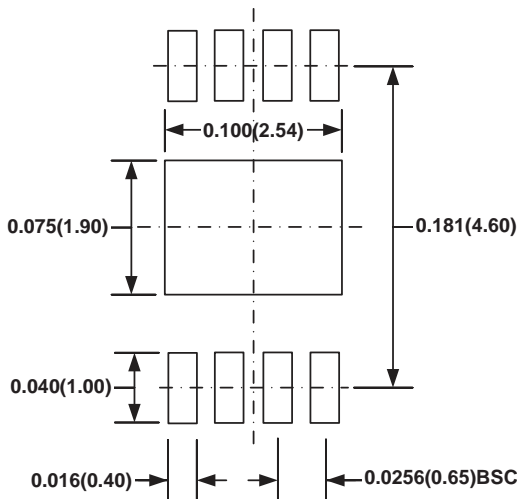
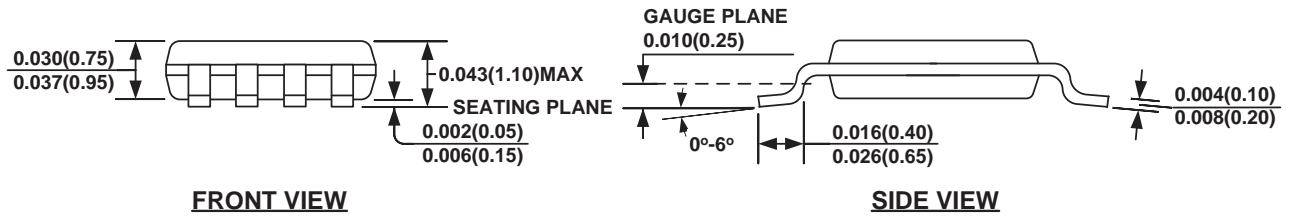
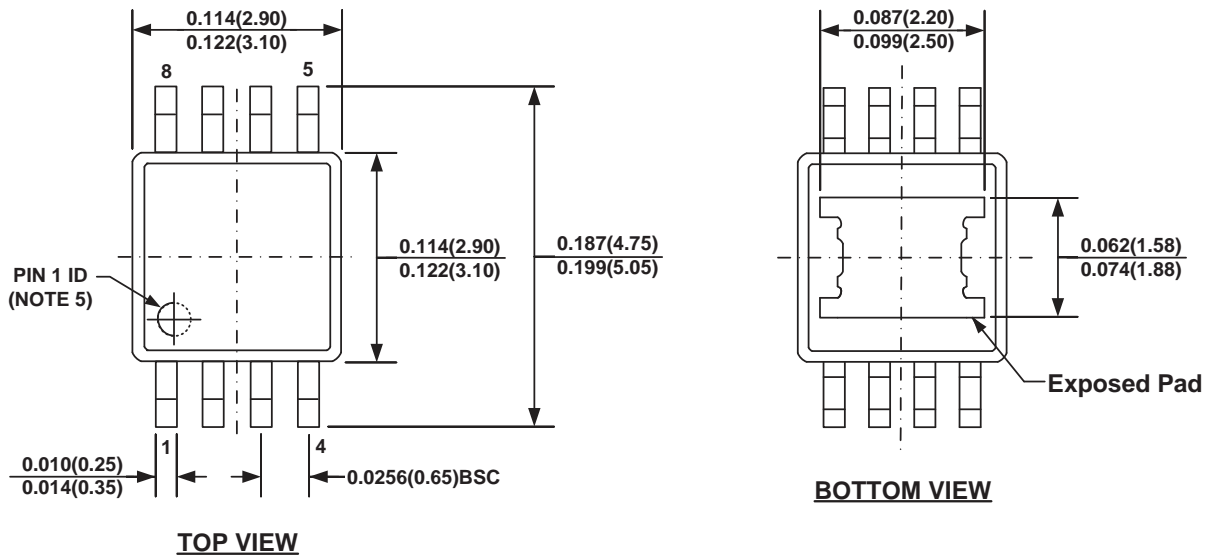

#### NOTE:

- 1) CONTROL DIMENSION IS IN INCHES. DIMENSION IN BRACKET IS IN MILLIMETERS.
- 2) PACKAGE LENGTH DOES NOT INCLUDE MOLD FLASH, PROTRUSION OR GATE BURR.
- 3) PACKAGE WIDTH DOES NOT INCLUDE INTERLEAD FLASH OR PROTRUSION.
- 4) LEAD COPLANARITY (BOTTOM OF LEADS AFTER FORMING) SHALL BE 0.004" INCHES MAX.
- 5) PIN 1 IDENTIFICATION HAS HALF OR FULL CIRCLE OPTION.
- 6) DRAWING MEETS JEDEC MO-187, VARIATION AA-T.
- 7) DRAWING IS NOT TO SCALE.

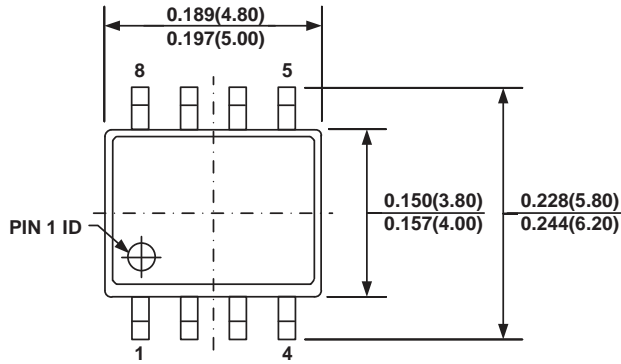
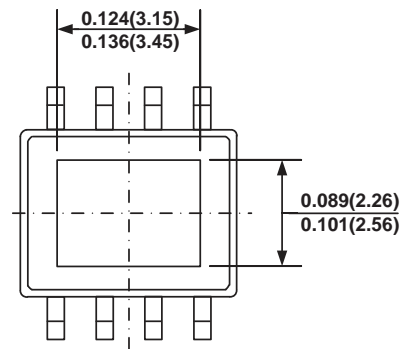
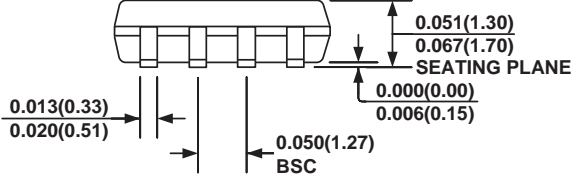
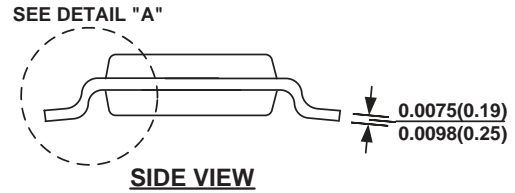
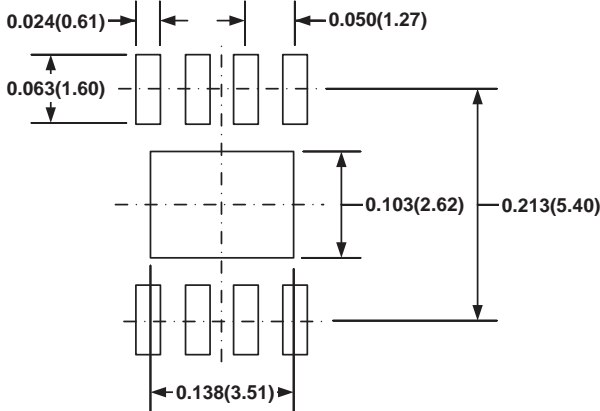
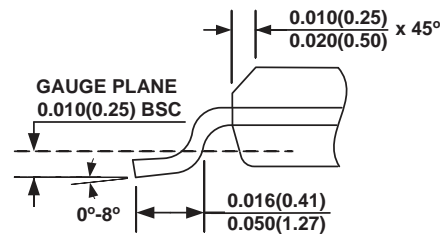

**SOIC8E (EXPOSED PAD)**

**TOP VIEW**

**BOTTOM VIEW**

**FRONT VIEW**

**SIDE VIEW**

**RECOMMENDED LAND PATTERN**

**DETAIL "A"**
**NOTE:**

- 1) CONTROL DIMENSION IS IN INCHES. DIMENSION IN BRACKET IS IN MILLIMETERS.
- 2) PACKAGE LENGTH DOES NOT INCLUDE MOLD FLASH, PROTRUSIONS OR GATE BURRS.
- 3) PACKAGE WIDTH DOES NOT INCLUDE INTERLEAD FLASH OR PROTRUSIONS.
- 4) LEAD COPLANARITY (BOTTOM OF LEADS AFTER FORMING) SHALL BE 0.004" INCHES MAX.
- 5) DRAWING CONFORMS TO JEDEC MS-012, VARIATION BA.
- 6) DRAWING IS NOT TO SCALE.

**NOTICE:** The information in this document is subject to change without notice. Users should warrant and guarantee that third party Intellectual Property rights are not infringed upon when integrating MPS products into any application. MPS will not assume any legal responsibility for any said applications.

## Looking for pricing, stock, or lifecycle information?

Click below to explore more details on WIN SOURCE:

-  [View MP6211DH-LF-P on WIN SOURCE](#)
-  [Monolithic Power Systems Inc. Information](#)

## Optimize Your Supply Chain with WIN SOURCE Solutions

-  Global Sourcing Solution
-  Obsolete Management
-  Cost Control Management
-  Shortage Management
-  Alternative Solution
-  Excess Inventory Management