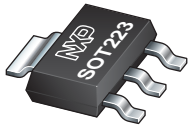




**THE DATASHEET OF  
NX1117C19Z,115**





# NX1117C; NX1117CE series

## Low-dropout linear regulators

Rev. 2 — 11 December 2012

Product data sheet

## 1. General description

The NX1117C/NX1117CE are two series of low-dropout positive voltage regulators with an output current capability of 1 A. The two series consist of 18 fixed output voltage versions and two adjustable output voltage versions. NX1117C series offers an output voltage accuracy of  $\pm 1\%$  and NX1117CE series of  $\pm 1.25\%$ .

The regulators feature output current limiting, Safe Operating Area (SOA) control, and thermal shutdown.

The NX1117C/NX1117CE series are housed in a medium power SOT223 (SC-73) Surface-Mounted Device (SMD) plastic package.

Table 1. Product overview

Output voltage $V_{out}$ (V)	Output voltage accuracy of $\pm 1\%$	Output voltage accuracy of $\pm 1.25\%$
1.25 adjustable	NX1117CADJZ	NX1117CEADJZ
1.2	NX1117C12Z	NX1117CE12Z
1.5	NX1117C15Z	NX1117CE15Z
1.8	NX1117C18Z	NX1117CE18Z
1.9	NX1117C19Z	NX1117CE19Z
2.0	NX1117C20Z	NX1117CE20Z
2.5	NX1117C25Z	NX1117CE25Z
2.85	NX1117C285Z	NX1117CE285Z
3.3	NX1117C33Z	NX1117CE33Z
5.0	NX1117C50Z	NX1117CE50Z

## 2. Features and benefits

- Maximum output current of 1 A
- Wide operation range to 20 V input
- Output voltage accuracy of  $\pm 1\%$  or  $\pm 1.25\%$
- Output current limiting
- SOA control
- Thermal shutdown
- No minimum load requirements for fixed output voltage versions
- Temperature range  $-40\text{ }^{\circ}\text{C}$  to  $125\text{ }^{\circ}\text{C}$



### 3. Applications

- Post regulator for switching DC-to-DC converter
- High-efficiency linear regulators
- Battery charger
- USB devices
- Hard drive controllers
- Consumer and industrial equipment point of load

### 4. Ordering information

Table 2. Ordering information

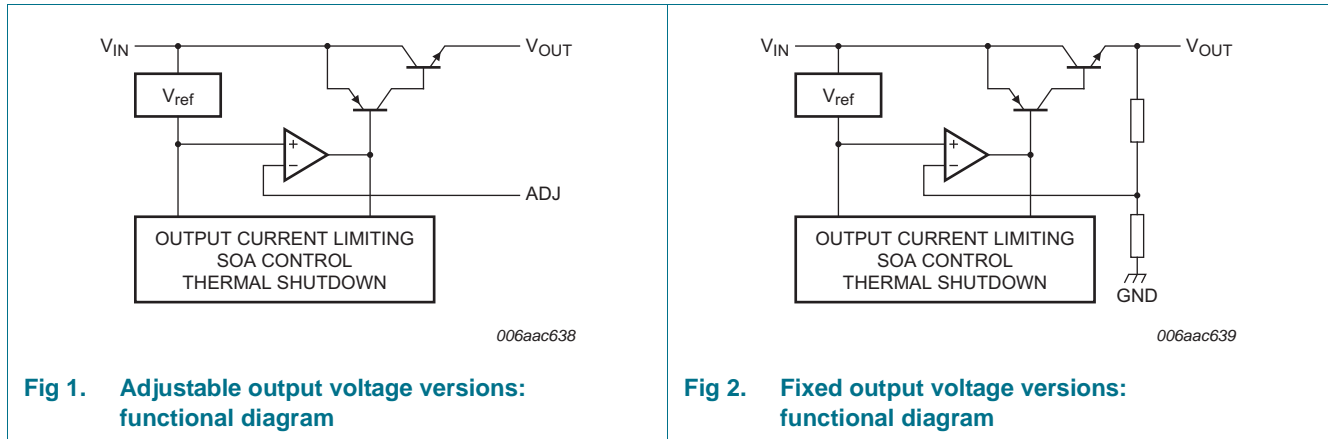
Type number	Package		
	Name	Description	Version
NX1117C/NX1117CE series	-	plastic surface-mounted package with increased heat sink; 4 leads	SOT223

### 5. Marking

Table 3. Marking codes

Type number	Marking code	Type number	Marking code
NX1117CADJZ	NCADJZ	NX1117CEADJZ	7CEADJ
NX1117C12Z	N7C12Z	NX1117CE12Z	7CE12Z
NX1117C15Z	N7C15Z	NX1117CE15Z	7CE15Z
NX1117C18Z	N7C18Z	NX1117CE18Z	7CE18Z
NX1117C19Z	N7C19Z	NX1117CE19Z	7CE19Z
NX1117C20Z	N7C20Z	NX1117CE20Z	7CE20Z
NX1117C25Z	N7C25Z	NX1117CE25Z	7CE25Z
NX1117C285Z	NC285Z	NX1117CE285Z	7CE285
NX1117C33Z	N7C33Z	NX1117CE33Z	7CE33Z
NX1117C50Z	N7C50Z	NX1117CE50Z	7CE50Z

## 6. Functional diagram



## 7. Pinning information

**Table 4. Pinning**

Pin	Symbol	Description	Simplified outline
1	ADJ or GND	adjust or ground	<a href="#">[1]</a>
2	V <sub>OUT</sub>	output	
3	V <sub>IN</sub>	input	
4	V <sub>OUT</sub>	output	

[1] ADJ for NX1117CADJZ and NX1117CEADJZ; GND for all other devices.

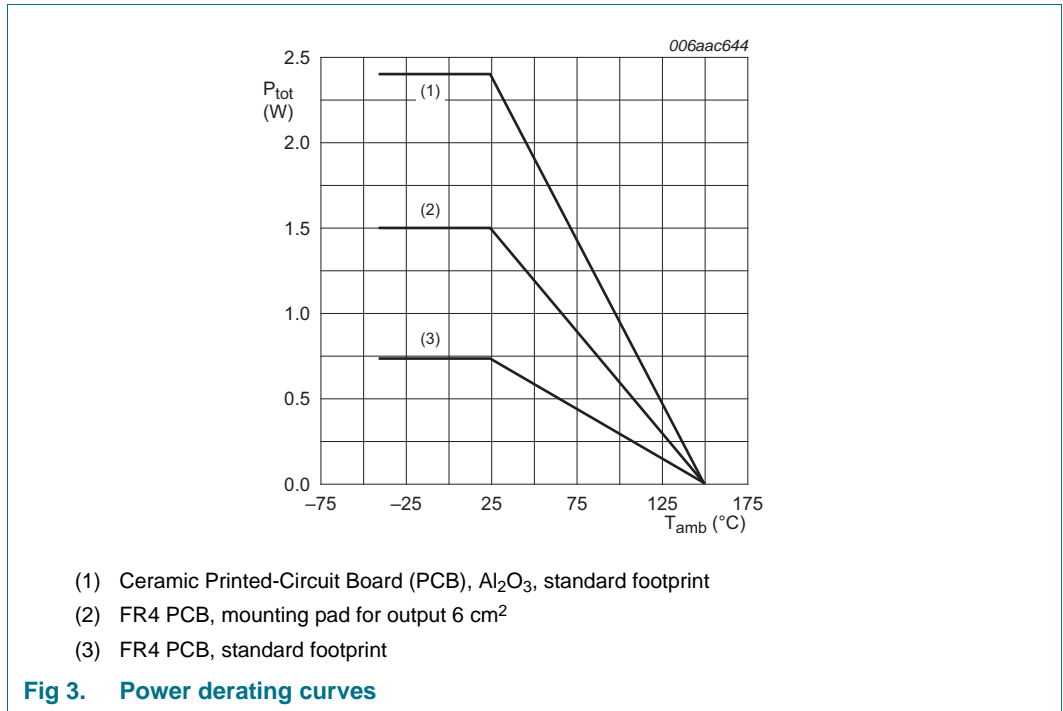
## 8. Limiting values

**Table 5. Limiting values**

In accordance with the Absolute Maximum Rating System (IEC 60134).

Symbol	Parameter	Conditions	Min	Max	Unit
V <sub>in</sub>	input voltage		-	20	V
V <sub>ESD</sub>	electrostatic discharge voltage	MIL-STD-883 (human body model)	2	-	kV
		machine model	400	-	V
P <sub>tot</sub>	total power dissipation		<a href="#">[1]</a>	internally limited	
T <sub>j</sub>	junction temperature		-	150	°C
T <sub>amb</sub>	ambient temperature		-40	+125	°C
T <sub>stg</sub>	storage temperature		-65	+150	°C

[1] The maximum package power dissipation is  $P_{tot} = \frac{T_j - T_{amb}}{R_{th(j-a)}}$ .



## 9. Recommended operating conditions

**Table 6. Recommended operation conditions**  
*T<sub>amb</sub> = 25 °C unless otherwise specified.*

Symbol	Parameter	Conditions	Min	Max	Unit
V <sub>in</sub>	input voltage		-	20	V

## 10. Thermal characteristics

**Table 7. Thermal characteristics**

Symbol	Parameter	Conditions	Min	Typ	Max	Unit	
R <sub>th(j-a)</sub>	thermal resistance from junction to ambient	in free air	[1]	-	-	150	K/W
			[2]	-	-	72	K/W
			[3]	-	-	45	K/W
R <sub>th(j-sp)</sub>	thermal resistance from junction to solder point		-	-	20	K/W	
T <sub>sd</sub>	shutdown temperature		-	135	-	°C	

- [1] Device mounted on an FR4 PCB, single-sided copper, tin-plated and standard footprint.
- [2] Device mounted on an FR4 PCB, single-sided copper, tin-plated, mounting pad for output 6 cm<sup>2</sup>.
- [3] Device mounted on a ceramic PCB, Al<sub>2</sub>O<sub>3</sub>, standard footprint.

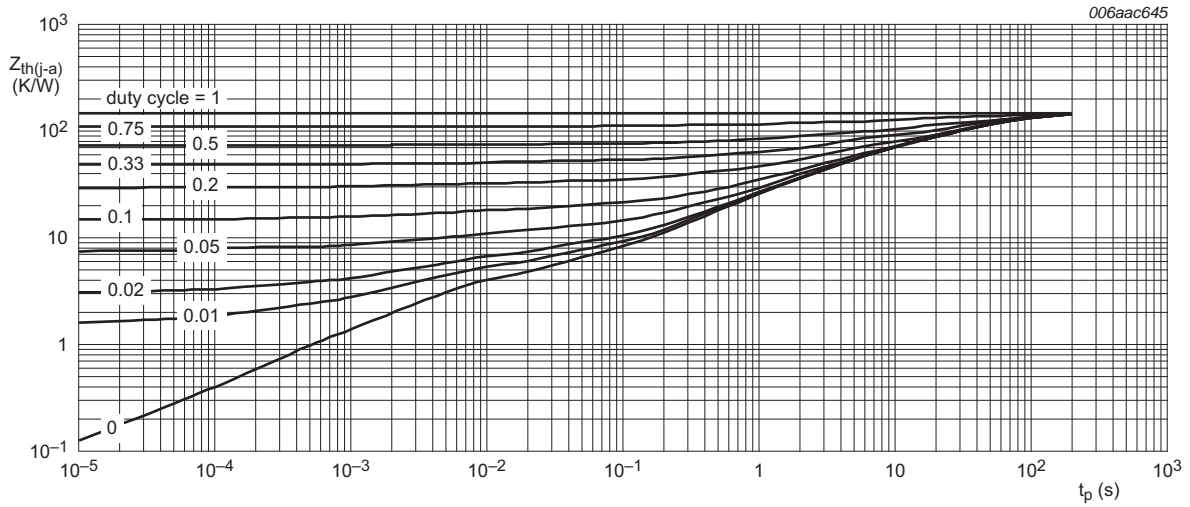


Fig 4. Transient thermal impedance from junction to ambient as a function of pulse duration; typical values

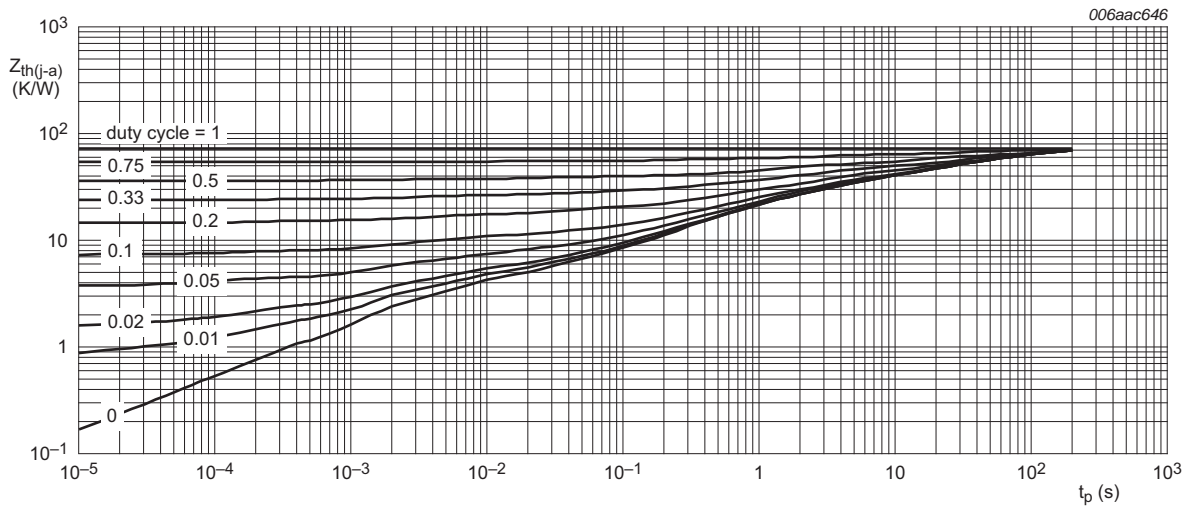
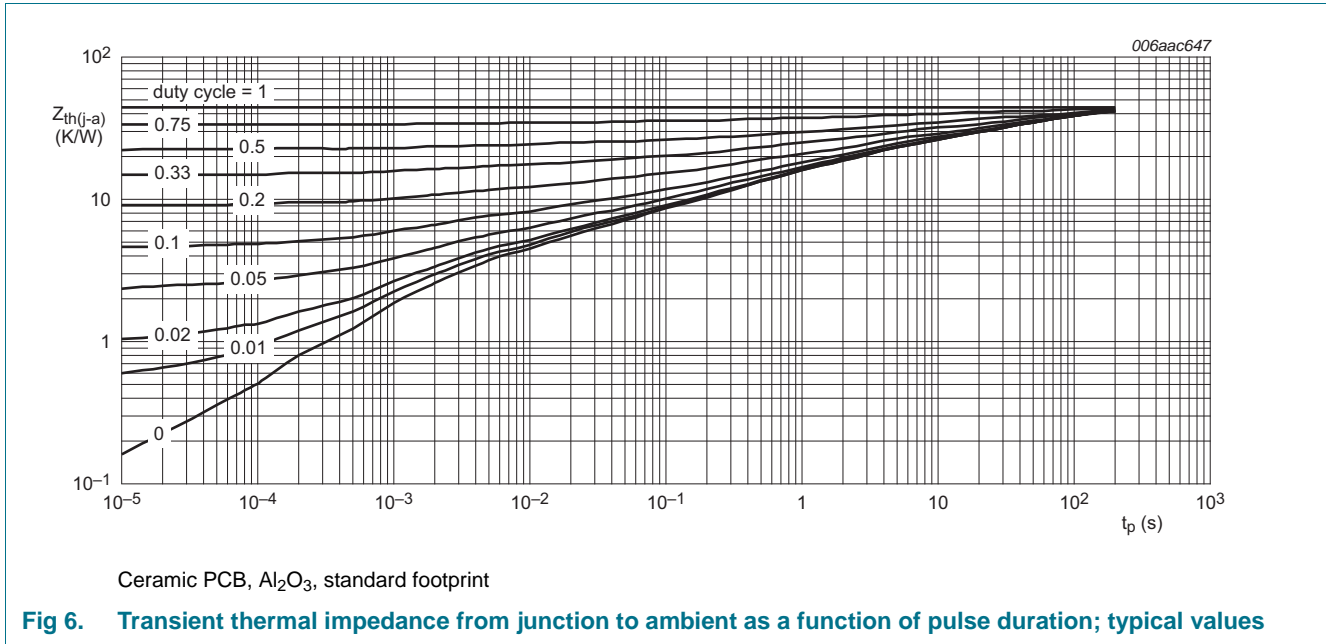


Fig 5. Transient thermal impedance from junction to ambient as a function of pulse duration; typical values



## 11. Characteristics

**Table 8. Characteristics**

$C_{in} = 680\text{ nF}$  in series with  $1\ \Omega$ , and  $C_{out} = 680\text{ nF}$  in series with  $1\ \Omega$ . For typical value  $T_{amb} = 25\text{ }^\circ\text{C}$ ; for minimum and maximum values  $T_{amb}$  is the operating temperature range  $-40\text{ }^\circ\text{C}$  to  $125\text{ }^\circ\text{C}$ ; unless otherwise specified.

Symbol	Parameter	Conditions	Min	Typ	Max	Unit
$V_{ref}$	reference voltage					
	NX1117CADJZ	$I_{out} = 10\text{ mA}$ ; $V_{in} - V_{ref} = 2\text{ V}$ ; $T_{amb} = 25\text{ }^\circ\text{C}$	1.238	1.250	1.262	V
		$10\text{ mA} \leq I_{out} \leq 800\text{ mA}$ ; $1.5\text{ V} \leq V_{in} - V_{ref} \leq 15\text{ V}$ [1]	1.225	-	1.275	V
	NX1117CEADJZ	$I_{out} = 10\text{ mA}$ ; $V_{in} - V_{ref} = 2\text{ V}$ ; $T_{amb} = 25\text{ }^\circ\text{C}$	1.234	1.250	1.266	V
$10\text{ mA} \leq I_{out} \leq 800\text{ mA}$ ; $1.5\text{ V} \leq V_{in} - V_{ref} \leq 15\text{ V}$ [1]		1.219	-	1.281	V	

**Table 8. Characteristics ...continued**

$C_{in} = 680 \text{ nF}$  in series with  $1 \Omega$ , and  $C_{out} = 680 \text{ nF}$  in series with  $1 \Omega$ . For typical value  $T_{amb} = 25 \text{ }^\circ\text{C}$ ; for minimum and maximum values  $T_{amb}$  is the operating temperature range  $-40 \text{ }^\circ\text{C}$  to  $125 \text{ }^\circ\text{C}$ ; unless otherwise specified.

Symbol	Parameter	Conditions	Min	Typ	Max	Unit
$V_{out}$	output voltage	$I_{out} = 10 \text{ mA}$ ; $V_{in} = 3.2 \text{ V}$ ; $T_{amb} = 25 \text{ }^\circ\text{C}$	1.188	1.200	1.212	V
		$0 \text{ mA} \leq I_{out} \leq 800 \text{ mA}$ ; $2.6 \text{ V} \leq V_{in} \leq 11.2 \text{ V}$	[1] 1.176	-	1.224	V
NX1117C12Z		$I_{out} = 10 \text{ mA}$ ; $V_{in} = 3.2 \text{ V}$ ; $T_{amb} = 25 \text{ }^\circ\text{C}$	1.185	1.200	1.215	V
		$0 \text{ mA} \leq I_{out} \leq 800 \text{ mA}$ ; $2.6 \text{ V} \leq V_{in} \leq 11.2 \text{ V}$	[1] 1.170	-	1.230	V
NX1117CE12Z		$I_{out} = 10 \text{ mA}$ ; $V_{in} = 3.2 \text{ V}$ ; $T_{amb} = 25 \text{ }^\circ\text{C}$	1.485	1.500	1.515	V
		$0 \text{ mA} \leq I_{out} \leq 800 \text{ mA}$ ; $2.9 \text{ V} \leq V_{in} \leq 11.5 \text{ V}$	[1] 1.470	-	1.530	V
NX1117C15Z		$I_{out} = 10 \text{ mA}$ ; $V_{in} = 3.5 \text{ V}$ ; $T_{amb} = 25 \text{ }^\circ\text{C}$	1.481	1.500	1.519	V
		$0 \text{ mA} \leq I_{out} \leq 800 \text{ mA}$ ; $2.9 \text{ V} \leq V_{in} \leq 11.5 \text{ V}$	[1] 1.462	-	1.538	V
NX1117CE15Z		$I_{out} = 10 \text{ mA}$ ; $V_{in} = 3.5 \text{ V}$ ; $T_{amb} = 25 \text{ }^\circ\text{C}$	1.782	1.800	1.818	V
		$0 \text{ mA} \leq I_{out} \leq 800 \text{ mA}$ ; $3.2 \text{ V} \leq V_{in} \leq 11.8 \text{ V}$	[1] 1.764	-	1.836	V
NX1117C18Z		$I_{out} = 10 \text{ mA}$ ; $V_{in} = 3.8 \text{ V}$ ; $T_{amb} = 25 \text{ }^\circ\text{C}$	1.777	1.800	1.823	V
		$0 \text{ mA} \leq I_{out} \leq 800 \text{ mA}$ ; $3.2 \text{ V} \leq V_{in} \leq 11.8 \text{ V}$	[1] 1.755	-	1.845	V
NX1117CE18Z		$I_{out} = 10 \text{ mA}$ ; $V_{in} = 3.8 \text{ V}$ ; $T_{amb} = 25 \text{ }^\circ\text{C}$	1.881	1.900	1.919	V
		$0 \text{ mA} \leq I_{out} \leq 800 \text{ mA}$ ; $3.3 \text{ V} \leq V_{in} \leq 11.9 \text{ V}$	[1] 1.862	-	1.938	V
NX1117C19Z		$I_{out} = 10 \text{ mA}$ ; $V_{in} = 3.9 \text{ V}$ ; $T_{amb} = 25 \text{ }^\circ\text{C}$	1.876	1.900	1.924	V
		$0 \text{ mA} \leq I_{out} \leq 800 \text{ mA}$ ; $3.3 \text{ V} \leq V_{in} \leq 11.9 \text{ V}$	[1] 1.852	-	1.948	V
NX1117CE19Z		$I_{out} = 10 \text{ mA}$ ; $V_{in} = 3.9 \text{ V}$ ; $T_{amb} = 25 \text{ }^\circ\text{C}$	1.980	2.000	2.020	V
		$0 \text{ mA} \leq I_{out} \leq 800 \text{ mA}$ ; $3.4 \text{ V} \leq V_{in} \leq 12 \text{ V}$	[1] 1.960	-	2.040	V
NX1117C20Z		$I_{out} = 10 \text{ mA}$ ; $V_{in} = 4.0 \text{ V}$ ; $T_{amb} = 25 \text{ }^\circ\text{C}$	1.975	2.000	2.025	V
		$0 \text{ mA} \leq I_{out} \leq 800 \text{ mA}$ ; $3.4 \text{ V} \leq V_{in} \leq 12 \text{ V}$	[1] 1.950	-	2.050	V
NX1117CE20Z		$I_{out} = 10 \text{ mA}$ ; $V_{in} = 4.0 \text{ V}$ ; $T_{amb} = 25 \text{ }^\circ\text{C}$	2.475	2.500	2.525	V
		$0 \text{ mA} \leq I_{out} \leq 800 \text{ mA}$ ; $3.9 \text{ V} \leq V_{in} \leq 12 \text{ V}$	[1] 2.450	-	2.550	V
NX1117C25Z		$I_{out} = 10 \text{ mA}$ ; $V_{in} = 4.5 \text{ V}$ ; $T_{amb} = 25 \text{ }^\circ\text{C}$	2.469	2.500	2.531	V
		$0 \text{ mA} \leq I_{out} \leq 800 \text{ mA}$ ; $3.9 \text{ V} \leq V_{in} \leq 12 \text{ V}$	[1] 2.437	-	2.563	V
NX1117CE25Z		$I_{out} = 10 \text{ mA}$ ; $V_{in} = 4.5 \text{ V}$ ; $T_{amb} = 25 \text{ }^\circ\text{C}$	2.820	2.850	2.880	V
		$0 \text{ mA} \leq I_{out} \leq 800 \text{ mA}$ ; $4.25 \text{ V} \leq V_{in} \leq 10 \text{ V}$	[1] 2.790	-	2.910	V
NX1117C285Z		$I_{out} = 10 \text{ mA}$ ; $V_{in} = 4.85 \text{ V}$ ; $T_{amb} = 25 \text{ }^\circ\text{C}$	2.814	2.850	2.886	V
		$0 \text{ mA} \leq I_{out} \leq 800 \text{ mA}$ ; $4.25 \text{ V} \leq V_{in} \leq 10 \text{ V}$	[1] 2.779	-	2.921	V
NX1117CE285Z		$I_{out} = 10 \text{ mA}$ ; $V_{in} = 4.85 \text{ V}$ ; $T_{amb} = 25 \text{ }^\circ\text{C}$	3.267	3.300	3.333	V
		$0 \text{ mA} \leq I_{out} \leq 800 \text{ mA}$ ; $4.75 \text{ V} \leq V_{in} \leq 10 \text{ V}$	[1] 3.235	-	3.365	V
NX1117C33Z		$I_{out} = 10 \text{ mA}$ ; $V_{in} = 5.3 \text{ V}$ ; $T_{amb} = 25 \text{ }^\circ\text{C}$	3.259	3.300	3.341	V
		$0 \text{ mA} \leq I_{out} \leq 800 \text{ mA}$ ; $4.75 \text{ V} \leq V_{in} \leq 10 \text{ V}$	[1] 3.217	-	3.383	V
NX1117CE33Z		$I_{out} = 10 \text{ mA}$ ; $V_{in} = 5.3 \text{ V}$ ; $T_{amb} = 25 \text{ }^\circ\text{C}$	4.950	5.000	5.050	V
		$0 \text{ mA} \leq I_{out} \leq 800 \text{ mA}$ ; $6.5 \text{ V} \leq V_{in} \leq 12 \text{ V}$	[1] 4.900	-	5.100	V
NX1117C50Z		$I_{out} = 10 \text{ mA}$ ; $V_{in} = 7.0 \text{ V}$ ; $T_{amb} = 25 \text{ }^\circ\text{C}$	4.937	5.000	5.063	V
		$0 \text{ mA} \leq I_{out} \leq 800 \text{ mA}$ ; $6.5 \text{ V} \leq V_{in} \leq 12 \text{ V}$	[1] 4.875	-	5.125	V

**Table 8. Characteristics ...continued**

$C_{in} = 680 \text{ nF}$  in series with  $1 \Omega$ , and  $C_{out} = 680 \text{ nF}$  in series with  $1 \Omega$ . For typical value  $T_{amb} = 25 \text{ }^\circ\text{C}$ ; for minimum and maximum values  $T_{amb}$  is the operating temperature range  $-40 \text{ }^\circ\text{C}$  to  $125 \text{ }^\circ\text{C}$ ; unless otherwise specified.

Symbol	Parameter	Conditions	Min	Typ	Max	Unit	
$V_{do}$	dropout voltage	measured at $V_{out} - 100 \text{ mV}$					
		$I_{out} = 100 \text{ mA}$	-	0.95	1.1	V	
		$I_{out} = 500 \text{ mA}$	-	1.01	1.15	V	
		$I_{out} = 800 \text{ mA}$	-	1.07	1.2	V	
$I_{out(lim)}$	output current limit	$V_{in} - V_{out} = 5.0 \text{ V}$ ; $T_{amb} = 25 \text{ }^\circ\text{C}$	1000	1200	1500	mA	
$I_q$	quiescent current	NX1117C12Z; NX1117CE12Z	$V_{in} = 11.2 \text{ V}$	-	5	6	mA
		NX1117C15Z; NX1117CE15Z	$V_{in} = 11.5 \text{ V}$	-	5	6	mA
		NX1117C18Z; NX1117CE18Z	$V_{in} = 11.8 \text{ V}$	-	5	6	mA
		NX1117C19Z; NX1117CE19Z	$V_{in} = 11.9 \text{ V}$	-	5	6	mA
		NX1117C20Z; NX1117CE20Z	$V_{in} = 12 \text{ V}$	-	5	6	mA
		NX1117C25Z; NX1117CE25Z	$V_{in} = 10 \text{ V}$	-	5	6	mA
		NX1117C285Z; NX1117CE285Z	$V_{in} = 10 \text{ V}$	-	5	6	mA
		NX1117C33Z; NX1117CE33Z	$V_{in} = 15 \text{ V}$	-	5	6	mA
		NX1117C50Z; NX1117CE50Z	$V_{in} = 15 \text{ V}$	-	5	6	mA
$I_{adj}$	adjust current	NX1117CADJZ; NX1117CEADJZ	$V_{in} = 11.25 \text{ V}$ ; $I_{out} = 800 \text{ mA}$	-	52	120	$\mu\text{A}$
		$\Delta I_{adj}$	adjust current variation	$1.4 \text{ V} \leq V_{in} - V_{out} \leq 10 \text{ V}$ ; $10 \text{ mA} \leq I_{out} \leq 800 \text{ mA}$	-	0.4	5

**Table 8. Characteristics ...continued**

$C_{in} = 680 \text{ nF}$  in series with  $1 \Omega$ , and  $C_{out} = 680 \text{ nF}$  in series with  $1 \Omega$ . For typical value  $T_{amb} = 25 \text{ °C}$ ; for minimum and maximum values  $T_{amb}$  is the operating temperature range  $-40 \text{ °C}$  to  $125 \text{ °C}$ ; unless otherwise specified.

Symbol	Parameter	Conditions	Min	Typ	Max	Unit
<b>Regulation characteristics</b>						
$I_{out(min)}$	minimum output current	required for regulation				
	NX1117CADJZ; NX1117CEADJZ	$V_{in} = 15 \text{ V}$	-	0.8	5	mA
PSRR	power supply ripple rejection	$V_{in} - V_{out} = 2.4 \text{ V}$ ; $I_{out} = 40 \text{ mA}$ ; $2 \text{ V}_{(p-p)}$ 120 Hz sine wave				
	NX1117CADJZ; NX1117CEADJZ		-	69	-	dB
	NX1117C12Z; NX1117CE12Z		-	72	-	dB
	NX1117C15Z; NX1117CE15Z		-	69	-	dB
	NX1117C18Z; NX1117CE18Z		-	68	-	dB
	NX1117C19Z; NX1117CE19Z		-	67	-	dB
	NX1117C20Z; NX1117CE20Z		-	67	-	dB
	NX1117C25Z; NX1117CE25Z		-	65	-	dB
	NX1117C285Z; NX1117CE285Z		-	63	-	dB
	NX1117C33Z; NX1117CE33Z		-	62	-	dB
	NX1117C50Z; NX1117CE50Z		-	59	-	dB
$V_{n(out)RMS}$	RMS output noise voltage	$10 \text{ Hz} \leq f \leq 10 \text{ kHz}$	-	0.003	-	%

**Table 8. Characteristics ...continued**

$C_{in} = 680 \text{ nF}$  in series with  $1 \Omega$ , and  $C_{out} = 680 \text{ nF}$  in series with  $1 \Omega$ . For typical value  $T_{amb} = 25 \text{ }^\circ\text{C}$ ; for minimum and maximum values  $T_{amb}$  is the operating temperature range  $-40 \text{ }^\circ\text{C}$  to  $125 \text{ }^\circ\text{C}$ ; unless otherwise specified.

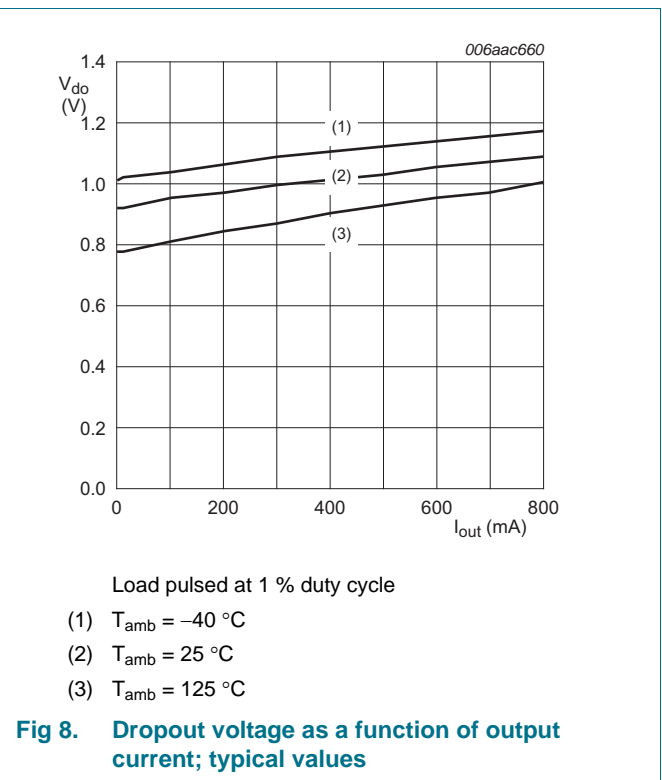
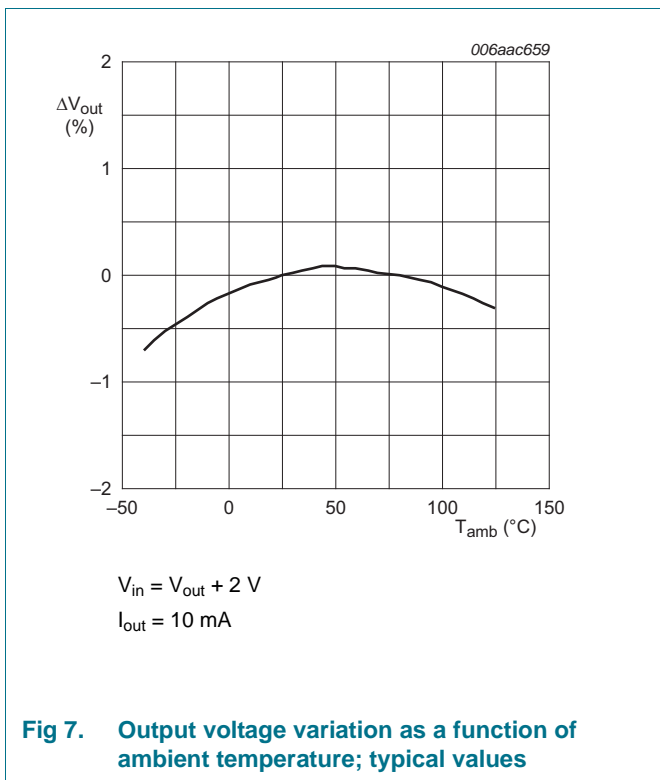
Symbol	Parameter	Conditions	Min	Typ	Max	Unit
<b>Line regulation</b>						
$\Delta V_{out}$	output voltage variation					<a href="#">[2]</a>
	NX1117CADJZ; NX1117CEADJZ	$I_{out} = 10 \text{ mA}; 2.75 \text{ V} \leq V_{in} \leq 16.25 \text{ V}$	-	0.1	0.3	%
	NX1117C12Z; NX1117CE12Z	$I_{out} = 0 \text{ mA}; 2.6 \text{ V} \leq V_{in} \leq 11.2 \text{ V}$	-	1.2	3.0	mV
	NX1117C15Z; NX1117CE15Z	$I_{out} = 0 \text{ mA}; 2.9 \text{ V} \leq V_{in} \leq 11.5 \text{ V}$	-	1.5	3.5	mV
	NX1117C18Z; NX1117CE18Z	$I_{out} = 0 \text{ mA}; 3.2 \text{ V} \leq V_{in} \leq 11.8 \text{ V}$	-	1.8	4.0	mV
	NX1117C19Z; NX1117CE19Z	$I_{out} = 0 \text{ mA}; 3.3 \text{ V} \leq V_{in} \leq 11.9 \text{ V}$	-	1.9	4.0	mV
	NX1117C20Z; NX1117CE20Z	$I_{out} = 0 \text{ mA}; 3.4 \text{ V} \leq V_{in} \leq 12 \text{ V}$	-	2.0	4.5	mV
	NX1117C25Z; NX1117CE25Z	$I_{out} = 0 \text{ mA}; 3.9 \text{ V} \leq V_{in} \leq 12 \text{ V}$	-	2.5	4.5	mV
	NX1117C285Z; NX1117CE285Z	$I_{out} = 0 \text{ mA}; 4.25 \text{ V} \leq V_{in} \leq 10 \text{ V}$	-	2.5	4.5	mV
	NX1117C33Z; NX1117CE33Z	$I_{out} = 0 \text{ mA}; 4.75 \text{ V} \leq V_{in} \leq 10 \text{ V}$	-	2.5	4.5	mV
	NX1117C50Z; NX1117CE50Z	$I_{out} = 0 \text{ mA}; 6.5 \text{ V} \leq V_{in} \leq 12 \text{ V}$	-	6.0	10	mV
<b>Load regulation</b>						
$\Delta V_{out}$	output voltage variation					<a href="#">[2]</a>
	NX1117CADJZ; NX1117CEADJZ	$V_{in} - V_{out} = 1.4 \text{ V}; 10 \text{ mA} \leq I_{out} \leq 800 \text{ mA}$	-	0.2	0.4	%
	NX1117C12Z; NX1117CE12Z	$V_{in} = 2.6 \text{ V}; 0 \text{ mA} \leq I_{out} \leq 800 \text{ mA}$	-	1	4	mV
	NX1117C15Z; NX1117CE15Z	$V_{in} = 2.9 \text{ V}; 0 \text{ mA} \leq I_{out} \leq 800 \text{ mA}$	-	1	5	mV
	NX1117C18Z; NX1117CE18Z	$V_{in} = 3.2 \text{ V}; 0 \text{ mA} \leq I_{out} \leq 800 \text{ mA}$	-	1	5	mV
	NX1117C19Z; NX1117CE19Z	$V_{in} = 3.3 \text{ V}; 0 \text{ mA} \leq I_{out} \leq 800 \text{ mA}$	-	1	6	mV
	NX1117C20Z; NX1117CE20Z	$V_{in} = 3.4 \text{ V}; 0 \text{ mA} \leq I_{out} \leq 800 \text{ mA}$	-	1	6	mV
	NX1117C25Z; NX1117CE25Z	$V_{in} = 3.9 \text{ V}; 0 \text{ mA} \leq I_{out} \leq 800 \text{ mA}$	-	1	6	mV
	NX1117C285Z; NX1117CE285Z	$V_{in} = 4.25 \text{ V}; 0 \text{ mA} \leq I_{out} \leq 800 \text{ mA}$	-	1	7	mV
	NX1117C33Z; NX1117CE33Z	$V_{in} = 4.75 \text{ V}; 0 \text{ mA} \leq I_{out} \leq 800 \text{ mA}$	-	1	7	mV
	NX1117C50Z; NX1117CE50Z	$V_{in} = 6.5 \text{ V}; 0 \text{ mA} \leq I_{out} \leq 800 \text{ mA}$	-	1	10	mV

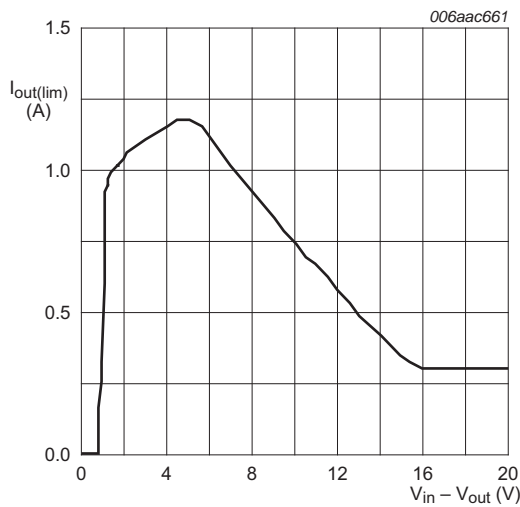
**Table 8. Characteristics ...continued**

$C_{in} = 680\text{ nF}$  in series with  $1\ \Omega$ , and  $C_{out} = 680\text{ nF}$  in series with  $1\ \Omega$ . For typical value  $T_{amb} = 25\text{ }^\circ\text{C}$ ; for minimum and maximum values  $T_{amb}$  is the operating temperature range  $-40\text{ }^\circ\text{C}$  to  $125\text{ }^\circ\text{C}$ ; unless otherwise specified.

Symbol	Parameter	Conditions	Min	Typ	Max	Unit
<b>Temperature stability</b>						
$\Delta V_{out}$	output voltage variation	$-40\text{ }^\circ\text{C} \leq T_{amb} \leq 125\text{ }^\circ\text{C}$	-	0.7	-	%
<b>Long-term stability</b>						
$\Delta V_{out}$	output voltage variation	1000 h end-point measurement; $T_{amb} = 25\text{ }^\circ\text{C}$	-	0.3	-	%

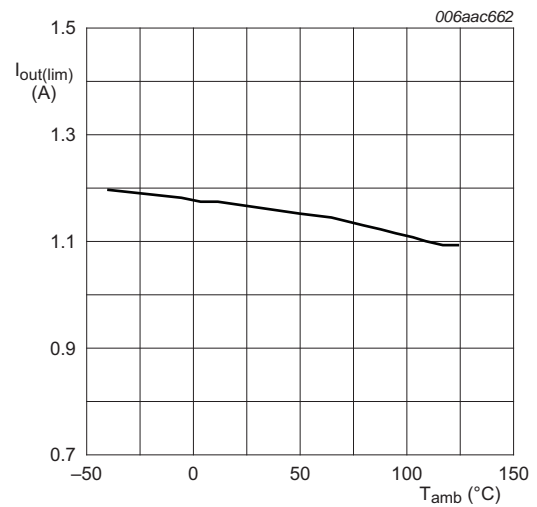
- [1] The SOA control limits the output current at high voltage differences  $V_{in} - V_{out}$  in order to keep the device in the safe operating area.
- [2] During testing low duty cycle pulse techniques are used to maintain the junction temperature as close to ambient as possible.





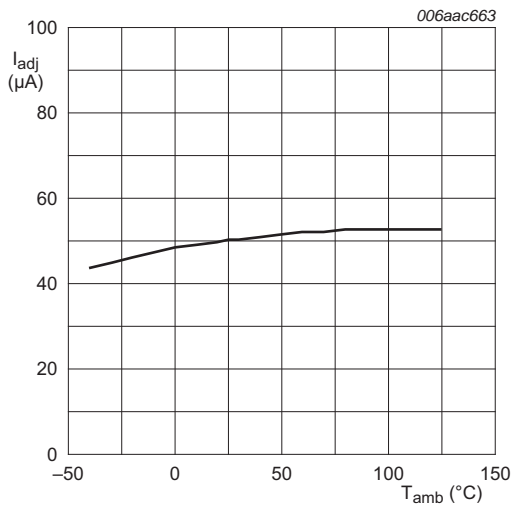
$T_{amb} = 25\text{ }^{\circ}\text{C}$   
Load pulsed at 1 % duty cycle

**Fig 9. Output current limit as a function of voltage difference  $V_{in} - V_{out}$**



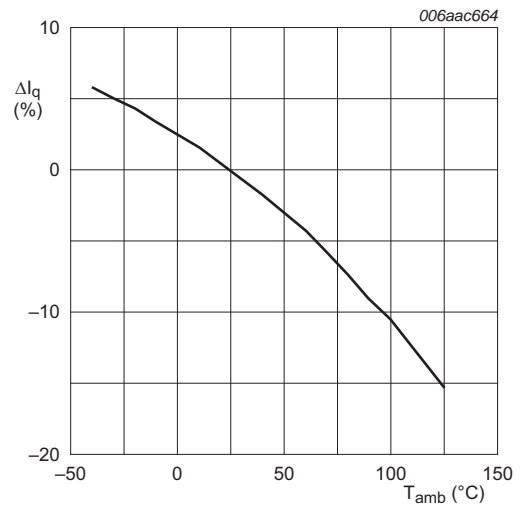
$V_{in} = 5\text{ V}$   
Load pulsed at 1 % duty cycle

**Fig 10. Output current limit as a function of ambient temperature**

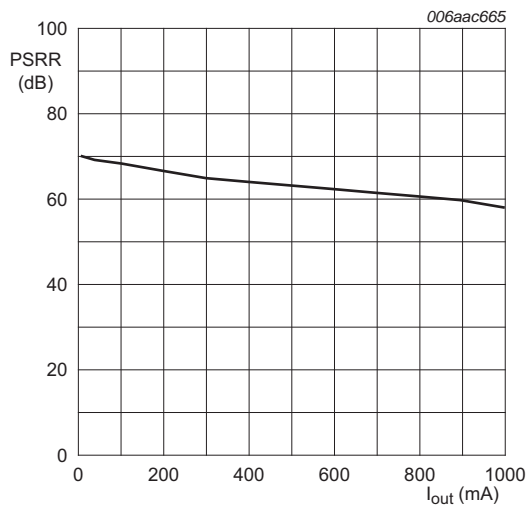


$V_{in} = 3.25\text{ V}$   
 $I_{out} = 10\text{ mA}$

**Fig 11. Adjustable output voltage versions: Adjust current as a function of ambient temperature; typical values**

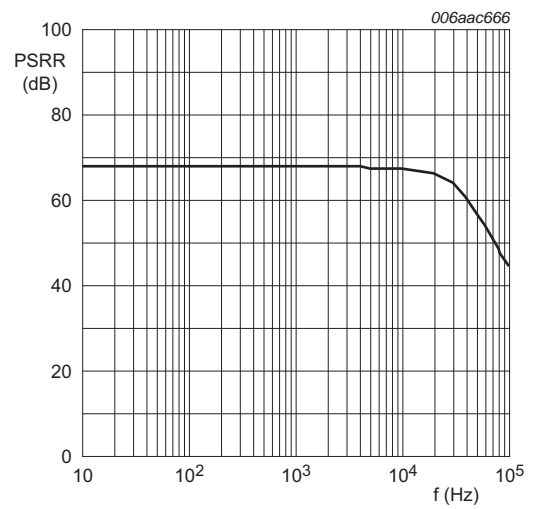


**Fig 12. Fixed output voltage versions: Quiescent current variation as a function of ambient temperature; typical values**



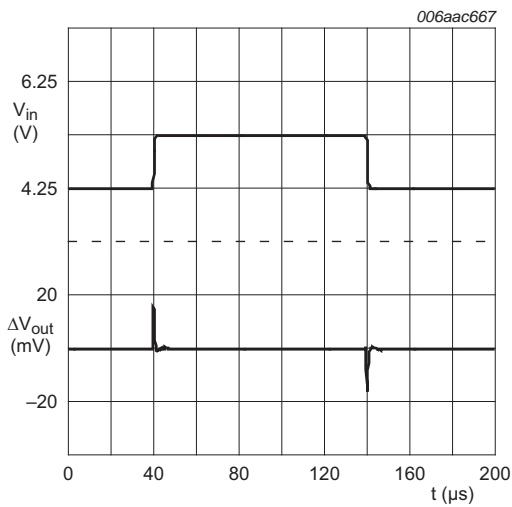
$V_{out} = 1.25\text{ V};$   
 $V_{in} - V_{out} = 2.4\text{ V};$   
 $C_{out} = 680\text{ nF};$   
 $T_{amb} = 25\text{ }^{\circ}\text{C};$   
 $2\text{ V}_{(p-p)}; 120\text{ Hz sine wave}$

**Fig 13. Adjustable output voltage versions: Power supply ripple rejection as a function of output current; typical values**



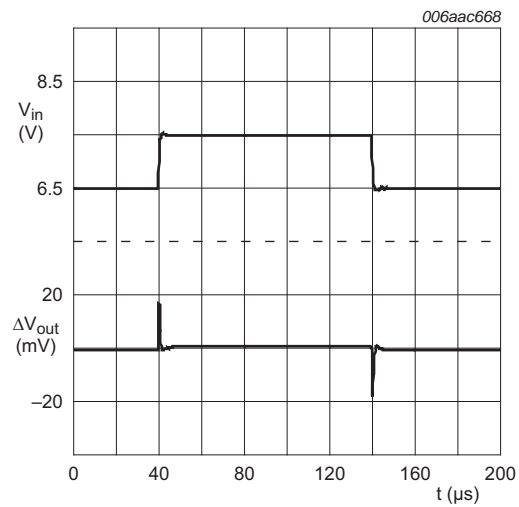
$V_{in} - V_{out} = 2.4\text{ V};$   
 $I_{out} = 40\text{ mA};$   
 $C_{out} = 10\text{ }\mu\text{F};$   
 $T_{amb} = 25\text{ }^{\circ}\text{C};$   
 $2\text{ V}_{(p-p)}$

**Fig 14. Power supply ripple rejection as a function of frequency; typical values**



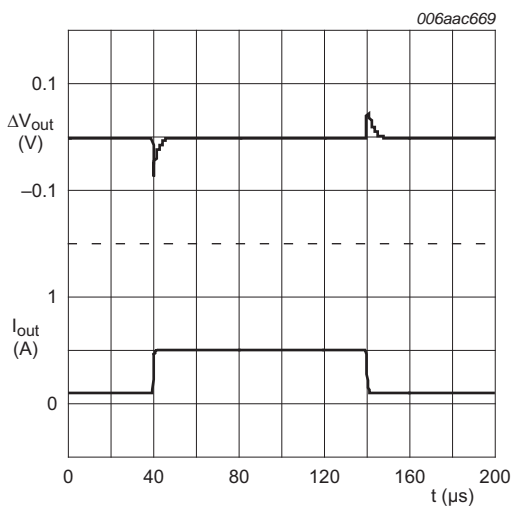
$C_{out} = 10 \mu\text{F};$   
 $I_{out} = 100 \text{ mA};$   
 $T_{amb} = 25 \text{ }^\circ\text{C}$

**Fig 15. NX1117C285Z and NX1117CE285Z:**  
**Line transient response as a function of time;**  
**typical values**



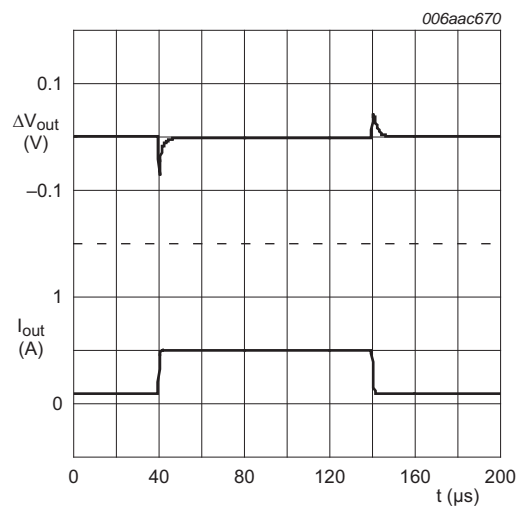
$C_{out} = 10 \mu\text{F};$   
 $I_{out} = 100 \text{ mA};$   
 $T_{amb} = 25 \text{ }^\circ\text{C}$

**Fig 16. NX1117C50Z and NX1117CE50Z:**  
**Line transient response as a function of time;**  
**typical values**



$C_{in} = 10 \mu\text{F};$   
 $C_{out} = 10 \mu\text{F};$   
 $V_{in} = 4.5 \text{ V}$   
 $T_{amb} = 25 \text{ }^\circ\text{C};$   
 $\text{Preload} = 100 \text{ mA}$

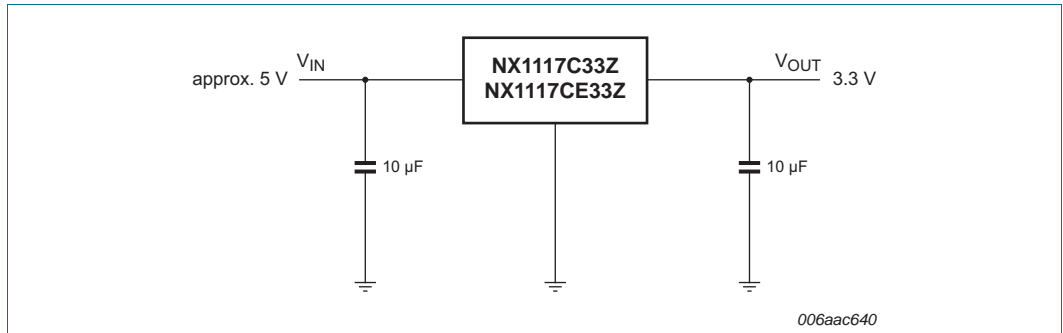
**Fig 17. NX1117C285Z and NX1117CE285Z:**  
**Load transient response as a function of time;**  
**typical values**



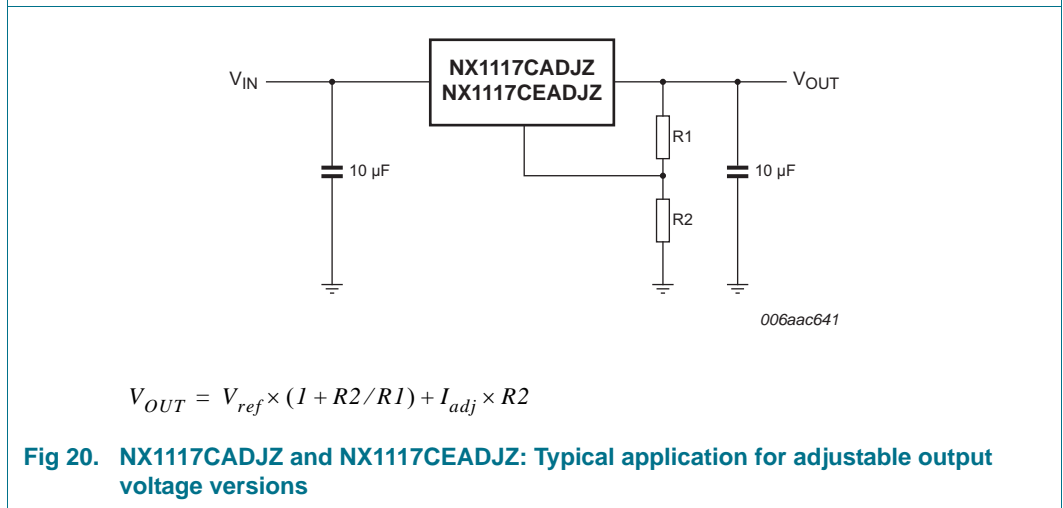
$C_{in} = 10 \mu\text{F};$   
 $C_{out} = 10 \mu\text{F};$   
 $V_{in} = 6.5 \text{ V}$   
 $T_{amb} = 25 \text{ }^\circ\text{C};$   
 $\text{Preload} = 100 \text{ mA}$

**Fig 18. NX1117C50Z and NX1117CE50Z:**  
**Load transient response as a function of time;**  
**typical values**

## 12. Application information

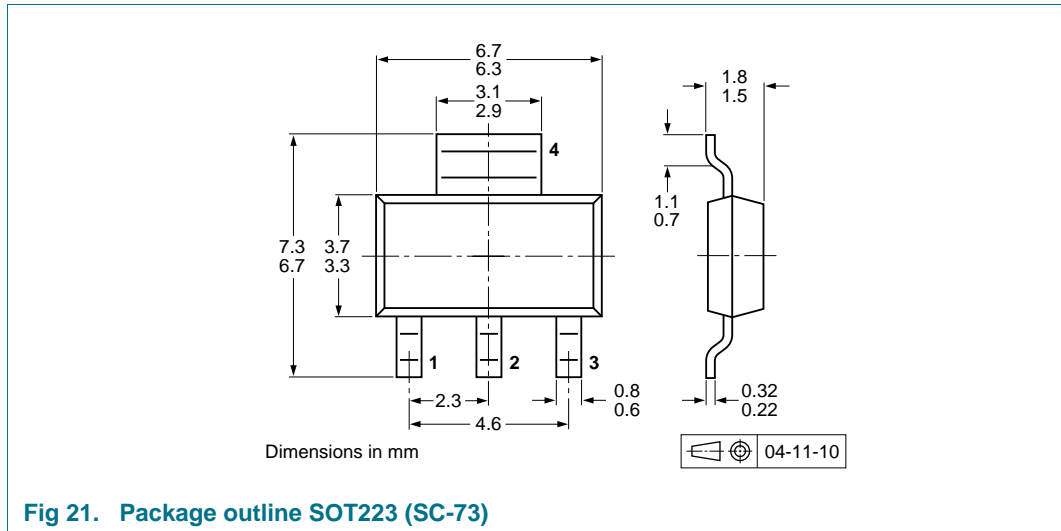


**Fig 19. NX1117C33Z and NX1117CE33Z: Typical application for fixed output voltage versions**



**Fig 20. NX1117CADJZ and NX1117CEADJZ: Typical application for adjustable output voltage versions**

## 13. Package outline



## 14. Packing information

**Table 9. Packing methods**

The indicated -xxx are the last three digits of the 12NC ordering code.<sup>[1]</sup>

Type number	Package	Description	Packing quantity	
			1000	4000
NX1117C/NX1117CE series	SOT223	8 mm pitch, 12 mm tape and reel	-115	-135

[1] For further information and the availability of packing methods, see [Section 18](#).

15. Soldering

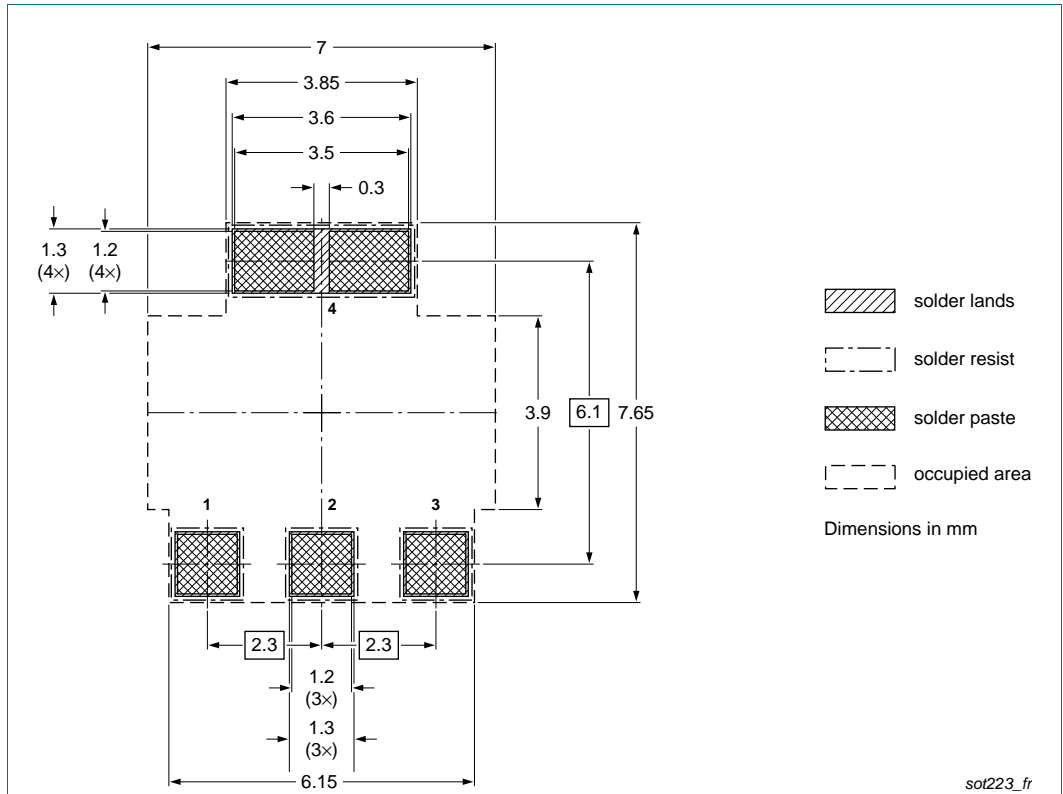


Fig 22. Reflow soldering footprint SOT223 (SC-73)

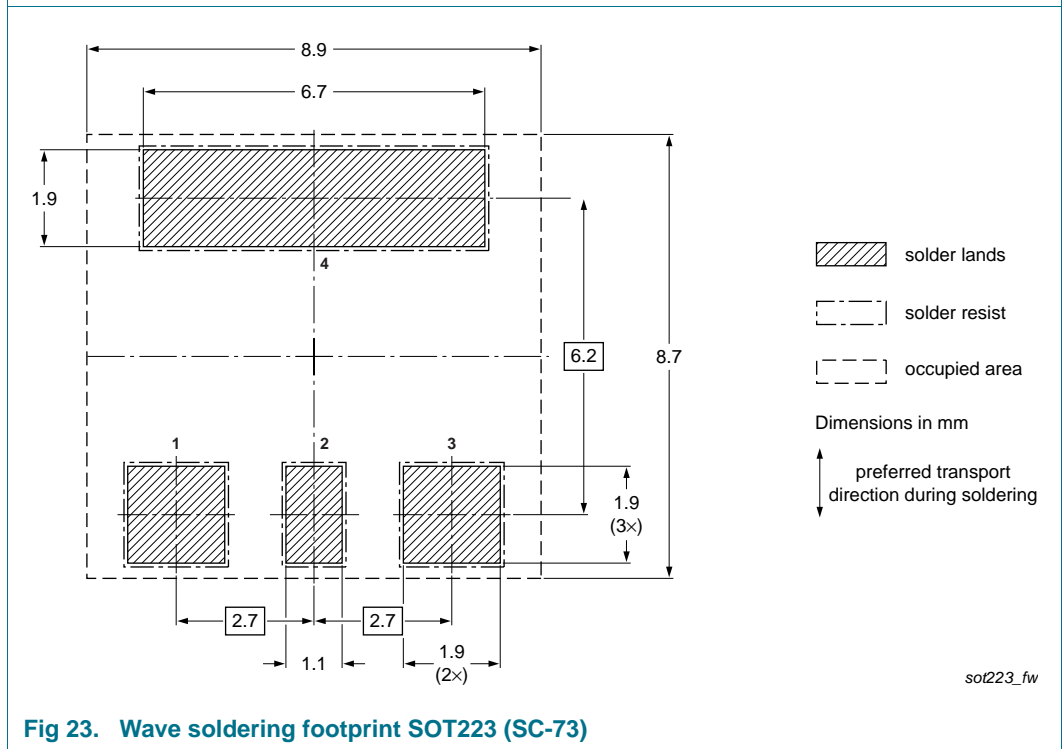


Fig 23. Wave soldering footprint SOT223 (SC-73)

## 16. Revision history

Table 10. Revision history

Document ID	Release date	Data sheet status	Change notice	Supersedes
NX1117C_NX1117CE_SER v.2	20121211	Product data sheet	-	NX1117C_NX1117CE_SER v.1
Modifications:				
				<ul style="list-style-type: none"><li>• <a href="#">Table 7 "Thermal characteristics"</a>: added shutdown temperature <math>T_{sd}</math></li><li>• Electrostatic discharge voltage <math>V_{ESD}</math> moved from <a href="#">Table 8</a> to <a href="#">Table 5</a></li></ul>
NX1117C_NX1117CE_SER v.1	20110718	Product data sheet	-	-

## 17. Legal information

### 17.1 Data sheet status

Document status <sup>[1][2]</sup>	Product status <sup>[3]</sup>	Definition
Objective [short] data sheet	Development	This document contains data from the objective specification for product development.
Preliminary [short] data sheet	Qualification	This document contains data from the preliminary specification.
Product [short] data sheet	Production	This document contains the product specification.

[1] Please consult the most recently issued document before initiating or completing a design.

[2] The term 'short data sheet' is explained in section "Definitions".

[3] The product status of device(s) described in this document may have changed since this document was published and may differ in case of multiple devices. The latest product status information is available on the Internet at URL <http://www.nxp.com>.

### 17.2 Definitions

**Draft** — The document is a draft version only. The content is still under internal review and subject to formal approval, which may result in modifications or additions. NXP Semiconductors does not give any representations or warranties as to the accuracy or completeness of information included herein and shall have no liability for the consequences of use of such information.

**Short data sheet** — A short data sheet is an extract from a full data sheet with the same product type number(s) and title. A short data sheet is intended for quick reference only and should not be relied upon to contain detailed and full information. For detailed and full information see the relevant full data sheet, which is available on request via the local NXP Semiconductors sales office. In case of any inconsistency or conflict with the short data sheet, the full data sheet shall prevail.

**Product specification** — The information and data provided in a Product data sheet shall define the specification of the product as agreed between NXP Semiconductors and its customer, unless NXP Semiconductors and customer have explicitly agreed otherwise in writing. In no event however, shall an agreement be valid in which the NXP Semiconductors product is deemed to offer functions and qualities beyond those described in the Product data sheet.

### 17.3 Disclaimers

**Limited warranty and liability** — Information in this document is believed to be accurate and reliable. However, NXP Semiconductors does not give any representations or warranties, expressed or implied, as to the accuracy or completeness of such information and shall have no liability for the consequences of use of such information. NXP Semiconductors takes no responsibility for the content in this document if provided by an information source outside of NXP Semiconductors.

In no event shall NXP Semiconductors be liable for any indirect, incidental, punitive, special or consequential damages (including - without limitation - lost profits, lost savings, business interruption, costs related to the removal or replacement of any products or rework charges) whether or not such damages are based on tort (including negligence), warranty, breach of contract or any other legal theory.

Notwithstanding any damages that customer might incur for any reason whatsoever, NXP Semiconductors' aggregate and cumulative liability towards customer for the products described herein shall be limited in accordance with the *Terms and conditions of commercial sale* of NXP Semiconductors.

**Right to make changes** — NXP Semiconductors reserves the right to make changes to information published in this document, including without limitation specifications and product descriptions, at any time and without notice. This document supersedes and replaces all information supplied prior to the publication hereof.

**Suitability for use** — NXP Semiconductors products are not designed, authorized or warranted to be suitable for use in life support, life-critical or safety-critical systems or equipment, nor in applications where failure or malfunction of an NXP Semiconductors product can reasonably be expected to result in personal injury, death or severe property or environmental damage. NXP Semiconductors and its suppliers accept no liability for inclusion and/or use of NXP Semiconductors products in such equipment or applications and therefore such inclusion and/or use is at the customer's own risk.

**Applications** — Applications that are described herein for any of these products are for illustrative purposes only. NXP Semiconductors makes no representation or warranty that such applications will be suitable for the specified use without further testing or modification.

Customers are responsible for the design and operation of their applications and products using NXP Semiconductors products, and NXP Semiconductors accepts no liability for any assistance with applications or customer product design. It is customer's sole responsibility to determine whether the NXP Semiconductors product is suitable and fit for the customer's applications and products planned, as well as for the planned application and use of customer's third party customer(s). Customers should provide appropriate design and operating safeguards to minimize the risks associated with their applications and products.

NXP Semiconductors does not accept any liability related to any default, damage, costs or problem which is based on any weakness or default in the customer's applications or products, or the application or use by customer's third party customer(s). Customer is responsible for doing all necessary testing for the customer's applications and products using NXP Semiconductors products in order to avoid a default of the applications and the products or of the application or use by customer's third party customer(s). NXP does not accept any liability in this respect.

**Limiting values** — Stress above one or more limiting values (as defined in the Absolute Maximum Ratings System of IEC 60134) will cause permanent damage to the device. Limiting values are stress ratings only and (proper) operation of the device at these or any other conditions above those given in the Recommended operating conditions section (if present) or the Characteristics sections of this document is not warranted. Constant or repeated exposure to limiting values will permanently and irreversibly affect the quality and reliability of the device.

**Terms and conditions of commercial sale** — NXP Semiconductors products are sold subject to the general terms and conditions of commercial sale, as published at <http://www.nxp.com/profile/terms>, unless otherwise agreed in a valid written individual agreement. In case an individual agreement is concluded only the terms and conditions of the respective agreement shall apply. NXP Semiconductors hereby expressly objects to applying the customer's general terms and conditions with regard to the purchase of NXP Semiconductors products by customer.

**No offer to sell or license** — Nothing in this document may be interpreted or construed as an offer to sell products that is open for acceptance or the grant, conveyance or implication of any license under any copyrights, patents or other industrial or intellectual property rights.

**Export control** — This document as well as the item(s) described herein may be subject to export control regulations. Export might require a prior authorization from competent authorities.

**Quick reference data** — The Quick reference data is an extract of the product data given in the Limiting values and Characteristics sections of this document, and as such is not complete, exhaustive or legally binding.

**Non-automotive qualified products** — Unless this data sheet expressly states that this specific NXP Semiconductors product is automotive qualified, the product is not suitable for automotive use. It is neither qualified nor tested in accordance with automotive testing or application requirements. NXP Semiconductors accepts no liability for inclusion and/or use of non-automotive qualified products in automotive equipment or applications.

In the event that customer uses the product for design-in and use in automotive applications to automotive specifications and standards, customer (a) shall use the product without NXP Semiconductors' warranty of the product for such automotive applications, use and specifications, and (b) whenever customer uses the product for automotive applications beyond NXP Semiconductors' specifications such use shall be solely at customer's own risk, and (c) customer fully indemnifies NXP Semiconductors for any liability, damages or failed product claims resulting from customer design and use of the product for automotive applications beyond NXP Semiconductors' standard warranty and NXP Semiconductors' product specifications.

## 17.4 Trademarks

Notice: All referenced brands, product names, service names and trademarks are the property of their respective owners.

## 18. Contact information

---

For more information, please visit: <http://www.nxp.com>

For sales office addresses, please send an email to: [salesaddresses@nxp.com](mailto:salesaddresses@nxp.com)

## 19. Contents

---

1	General description .....	1
2	Features and benefits .....	1
3	Applications .....	2
4	Ordering information .....	2
5	Marking .....	2
6	Functional diagram .....	3
7	Pinning information .....	3
8	Limiting values .....	3
9	Recommended operating conditions .....	4
10	Thermal characteristics .....	4
11	Characteristics .....	6
12	Application information .....	15
13	Package outline .....	16
14	Packing information .....	16
15	Soldering .....	17
16	Revision history .....	18
17	Legal information .....	19
17.1	Data sheet status .....	19
17.2	Definitions .....	19
17.3	Disclaimers .....	19
17.4	Trademarks .....	20
18	Contact information .....	20
19	Contents .....	21

---

Please be aware that important notices concerning this document and the product(s) described herein, have been included in section 'Legal information'.

---

© NXP B.V. 2012.

All rights reserved.

For more information, please visit: <http://www.nxp.com>

For sales office addresses, please send an email to: [salesaddresses@nxp.com](mailto:salesaddresses@nxp.com)

Date of release: 11 December 2012

Document identifier: NX1117C\_NX1117CE\_SER




## Looking for pricing, stock, or lifecycle information?

Click below to explore more details on WIN SOURCE:

 [View NX1117C19Z,115 on WIN SOURCE](#)

 [NXP / Nexperia Information](#)

## Optimize Your Supply Chain with WIN SOURCE Solutions

-  Global Sourcing Solution
-  Obsolete Management
-  Cost Control Management
-  Shortage Management
-  Alternative Solution
-  Excess Inventory Management