



**THE DATASHEET OF  
SN74LVC1G06DBVT**



## SN74LVC1G06 Single Inverter Buffer/Driver With Open-Drain Output

### 1 Features

- ESD Protection Exceeds JESD 22
  - 2000-V Human Body Model (A114-A)
  - 200-V Machine Model (A115-A)
  - 1000-V Charged-Device Model (C101)
- Available in the Texas Instruments NanoFree™ Package
- Supports 5-V  $V_{CC}$  Operation
- Input and Open-Drain Output Accept Voltages up to 5.5 V
- Maximum  $t_{pd}$  of 4.5 ns at 3.3 V at 125°C
- Low Power Consumption, 10- $\mu$ A Maximum  $I_{CC}$
- $\pm 24$ -mA Output Drive at 3.3 V for open-drain devices
- $I_{off}$  Supports Partial-Power-Down Mode and Back-Drive Protection
- Latch-Up Performance Exceeds 100 mA Per JESD 78, Class II
- Can Be Used For Up or Down Translation
- Schmitt Trigger Action on All Ports

### 2 Applications

- AV Receivers
- Blu-ray Players and Home Theaters
- DVD Recorders and Players
- Desktop or Notebook PCs
- Digital Radio or Internet Radio Players
- Digital Video Cameras (DVC)
- Embedded PCs
- GPS: Personal Navigation Devices
- Mobile Internet Devices
- Network Projector Front-Ends
- Portable Media Players
- Pro Audio Mixers
- Smoke Detectors
- Solid State Drive (SSD): Enterprise
- High-Definition (HDTV)
- Tablets: Enterprise
- Audio Docks: Portable
- DLP Front Projection Systems
- DVR and DVS
- Digital Picture Frame (DPF)
- Digital Still Cameras

### 3 Description

This single inverter buffer and driver is designed for 1.65-V to 5.5-V  $V_{CC}$  operation.

NanoFree package technology is a major breakthrough in IC packaging concepts, using the die as the package.

The output of the SN74LVC1G06 device is open-drain and can be connected to other open-drain outputs to implement active-low wired-OR or active-high wired-AND functions. The maximum sink current is 32 mA.

This device is fully specified for partial-power-down applications using  $I_{off}$ . The  $I_{off}$  circuitry disables the outputs when the device is powered down. This inhibits current backflow into the device which prevents damage to the device.

#### Device Information<sup>(1)</sup>

PART NUMBER	PACKAGE	BODY SIZE (NOM)
SN74LVC1G06DBV	SOT-23 (5)	2.90 mm x 1.60 mm
SN74LVC1G06DCK	SC70 (5)	2.00 mm x 1.25 mm
SN74LVC1G06DRL	SOT-5X3 (5)	1.60 mm x 1.20 mm
SN74LVC1G06DRY	SON (6)	1.45 mm x 1.00 mm
SN74LVC1G06DSF	SON (6)	1.00 mm x 1.00 mm
SN74LVC1G06YZP	DSBGA (5)	1.40 mm x 0.90 mm
SN74LVC1G06YZV	DSBGA (4)	0.90 mm x 0.90 mm
SN74LVC1G06DPW	X2SON (5)	0.80 mm x 0.80 mm

(1) For all available packages, see the orderable addendum at the end of the data sheet.

#### Logic Diagram (Positive Logic)



## Table of Contents

<b>1 Features</b> .....	<b>1</b>	8.2 Functional Block Diagram .....	<b>9</b>
<b>2 Applications</b> .....	<b>1</b>	8.3 Feature Description .....	<b>9</b>
<b>3 Description</b> .....	<b>1</b>	8.4 Device Functional Modes .....	<b>10</b>
<b>4 Revision History</b> .....	<b>2</b>	<b>9 Application and Implementation</b> .....	<b>11</b>
<b>5 Pin Configuration and Functions</b> .....	<b>3</b>	9.1 Application Information .....	<b>11</b>
<b>6 Specifications</b> .....	<b>4</b>	9.2 Typical Application .....	<b>11</b>
6.1 Absolute Maximum Ratings .....	<b>4</b>	<b>10 Power Supply Recommendations</b> .....	<b>13</b>
6.2 ESD Ratings .....	<b>4</b>	<b>11 Layout</b> .....	<b>13</b>
6.3 Recommended Operating Conditions .....	<b>5</b>	11.1 Layout Guidelines .....	<b>13</b>
6.4 Thermal Information .....	<b>5</b>	11.2 Layout Example .....	<b>13</b>
6.5 Electrical Characteristics .....	<b>6</b>	<b>12 Device and Documentation Support</b> .....	<b>14</b>
6.6 Switching Characteristics: –40°C to +85°C .....	<b>6</b>	12.1 Receiving Notification of Documentation Updates .....	<b>14</b>
6.7 Switching Characteristics: –40°C to +125°C .....	<b>6</b>	12.2 Community Resources .....	<b>14</b>
6.8 Operating Characteristics .....	<b>6</b>	12.3 Trademarks .....	<b>14</b>
6.9 Typical Characteristics .....	<b>7</b>	12.4 Electrostatic Discharge Caution .....	<b>14</b>
<b>7 Parameter Measurement Information</b> .....	<b>8</b>	12.5 Glossary .....	<b>14</b>
<b>8 Detailed Description</b> .....	<b>9</b>	<b>13 Mechanical, Packaging, and Orderable Information</b> .....	<b>14</b>
8.1 Overview .....	<b>9</b>		

## 4 Revision History

NOTE: Page numbers for previous revisions may differ from page numbers in the current version.

<b>Changes from Revision Y (February 2017) to Revision Z</b>	<b>Page</b>
• Changed values in the Thermal Information table to align with JEDEC standards .....	<b>5</b>
• Updated Feature Description to include more detailed information about specific device features. ....	<b>9</b>
• Added DPW layout example .....	<b>13</b>

<b>Changes from Revision X (August 2015) to Revision Y</b>	<b>Page</b>
• Changed <i>Logic Diagram (Positive Logic)</i> labels from: A-1, Y-3 to: A-2, Y-4 .....	<b>1</b>
• Added <i>Receiving Notification of Documentation Updates</i> section .....	<b>14</b>

<b>Changes from Revision W (December 2013) to Revision X</b>	<b>Page</b>
• Added <i>Device Information</i> table, <i>Pin Configuration and Functions</i> section, <i>ESD Ratings</i> table, <i>Thermal Information</i> table, <i>Typical Characteristics</i> section, <i>Feature Description</i> section, <i>Device Functional Modes</i> , <i>Application and Implementation</i> section, <i>Power Supply Recommendations</i> section, <i>Layout</i> section, <i>Device and Documentation Support</i> section, and <i>Mechanical, Packaging, and Orderable Information</i> section .....	<b>1</b>

<b>Changes from Revision V (November 2012) to Revision W</b>	<b>Page</b>
• Updated document to new TI data sheet format .....	<b>1</b>
• Removed <i>Ordering Information</i> table. ....	<b>1</b>
• Updated $I_{off}$ in <i>Features</i> . ....	<b>1</b>
• Updated operating temperature range. ....	<b>5</b>

## 5 Pin Configuration and Functions

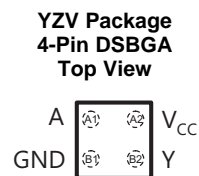
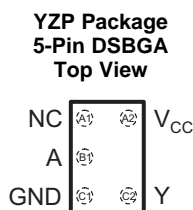
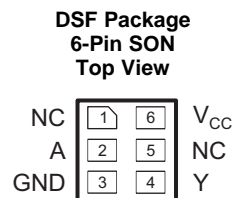
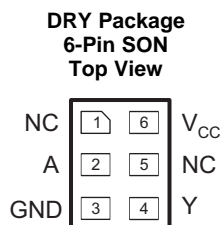
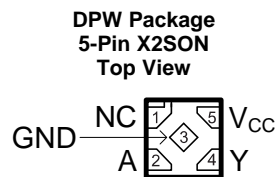
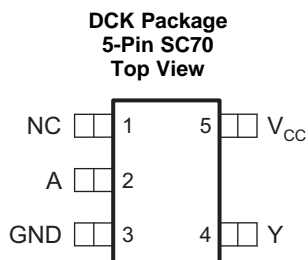
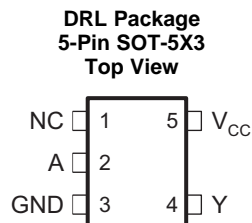
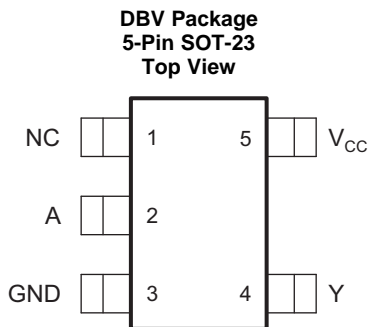

Pin Functions<sup>(1)(2)</sup>

NAME	PIN				I/O	DESCRIPTION
	DBV, DCK, DRL, DPW	DRY, DSF	YZP	YZV		
A	2	2	B1	A1	I	Input
DNU	—	—	A1	—	—	Do not use
GND	3	3	C1	B1	—	Ground
NC	1	1	—	—	—	Not connected
		5				
V <sub>CC</sub>	5	6	A2	A2	—	Power pin
Y	4	4	C2	B2	O	Output

(1) NC – No internal connection

(2) See mechanical drawings for dimensions.

## 6 Specifications

### 6.1 Absolute Maximum Ratings

over operating free-air temperature range (unless otherwise noted)<sup>(1)</sup>

		MIN	MAX	UNIT
V <sub>CC</sub>	Supply voltage	-0.5	6.5	V
V <sub>I</sub>	Input voltage <sup>(2)</sup>	-0.5	6.5	V
V <sub>O</sub>	Voltage applied to any output in the high-impedance or power-off state <sup>(2)</sup>	-0.5	6.5	V
V <sub>O</sub>	Voltage applied to any output in the high or low state <sup>(2)(3)</sup>	-0.5	6.5	V
I <sub>IK</sub>	Input clamp current	V <sub>I</sub> < 0	-50	mA
I <sub>OK</sub>	Output clamp current	V <sub>O</sub> < 0	-50	mA
I <sub>O</sub>	Continuous output current		±50	mA
	Continuous current through V <sub>CC</sub> or GND		±100	mA
T <sub>j</sub>	Junction temperature	-65	150	°C
T <sub>stg</sub>	Storage temperature	-65	150	°C

- (1) Stresses beyond those listed under *Absolute Maximum Ratings* may cause permanent damage to the device. These are stress ratings only, and functional operation of the device at these or any other conditions beyond those indicated under *Recommended Operating Conditions* is not implied. Exposure to absolute-maximum-rated conditions for extended periods may affect device reliability.
- (2) The input and output negative-voltage ratings may be exceeded if the input and output current ratings are observed.
- (3) The value of V<sub>CC</sub> is provided in the *Recommended Operating Conditions* table.

### 6.2 ESD Ratings

		VALUE	UNIT
V <sub>(ESD)</sub>	Electrostatic discharge	Human body model (HBM), per ANSI/ESDA/JEDEC JS-001 <sup>(1)</sup>	2000
		Charged-device model (CDM), per JEDEC specification JESD22-C101 <sup>(2)</sup>	1000
		Machine Model (MM), per A115-A	200

- (1) JEDEC document JEP155 states that 500-V HBM allows safe manufacturing with a standard ESD control process.
- (2) JEDEC document JEP157 states that 250-V CDM allows safe manufacturing with a standard ESD control process.

### 6.3 Recommended Operating Conditions

 over operating free-air temperature range (unless otherwise noted)<sup>(1)</sup>

		MIN	MAX	UNIT	
V <sub>CC</sub>	Supply voltage	Operating	1.65	5.5	V
		Data retention only	1.5		
V <sub>IH</sub>	High-level input voltage	V <sub>CC</sub> = 1.65 V to 1.95 V	0.65 × V <sub>CC</sub>		V
		V <sub>CC</sub> = 2.3 V to 2.7 V	1.7		
		V <sub>CC</sub> = 3 V to 3.6 V	2		
		V <sub>CC</sub> = 4.5 V to 5.5 V	0.7 × V <sub>CC</sub>		
V <sub>IL</sub>	Low-level input voltage	V <sub>CC</sub> = 1.65 V to 1.95 V	0.35 × V <sub>CC</sub>		V
		V <sub>CC</sub> = 2.3 V to 2.7 V	0.7		
		V <sub>CC</sub> = 3 V to 3.6 V	0.8		
		V <sub>CC</sub> = 4.5 V to 5.5 V	0.3 × V <sub>CC</sub>		
V <sub>I</sub>	Input voltage	0	5.5	V	
V <sub>O</sub>	Output voltage	0	5.5	V	
I <sub>OL</sub>	Low-level output current	V <sub>CC</sub> = 1.65 V	4		mA
		V <sub>CC</sub> = 2.3 V	8		
		V <sub>CC</sub> = 3 V	16		
			24		
		V <sub>CC</sub> = 4.5 V	32		
Δt/Δv	Input transition rise or fall rate	V <sub>CC</sub> = 1.8 V ± 0.15 V, 2.5 V ± 0.2 V	20		ns/V
		V <sub>CC</sub> = 3.3 V ± 0.3 V	10		
		V <sub>CC</sub> = 5 V ± 0.5 V	5		
T <sub>A</sub>	Operating free-air temperature	−40	125	°C	

(1) All unused inputs of the device must be held at V<sub>CC</sub> or GND to ensure proper device operation. See [Implications of Slow or Floating CMOS Inputs application report](#).

### 6.4 Thermal Information

THERMAL METRIC <sup>(1)</sup>	SN74LVC1G06							UNIT	
	DBV (SOT-23)	DCK (SC70)	DRL (SOT-5X3)	DRY (SON)	DPW (X2SON)	YZV (DSBGA)	YZP (DSBGA)		
	5 PINS	5 PINS	5 PINS	5 PINS	5 PINS	4 PINS	5 PINS		
R <sub>θJA</sub>	Junction-to-ambient thermal resistance	231.5	276.1	296.2	369.6	511	168.2	144.4	°C/W
R <sub>θJC(top)</sub>	Junction-to-case (top) thermal resistance	139.4	178.9	137.3	257.6	241.9	2.1	1.3	°C/W
R <sub>θJB</sub>	Junction-to-board thermal resistance	71.1	70.9	145.3	230.8	374.2	55.9	39.9	°C/W
Ψ <sub>JT</sub>	Junction-to-top characterization parameter	45.2	47	14.7	77.2	45	1.1	0.5	°C/W
Ψ <sub>JB</sub>	Junction-to-board characterization parameter	70.7	69.3	145.9	231	373.3	56.3	39.7	°C/W
R <sub>θJC(bot)</sub>	Junction-to-case (bottom) thermal resistance	N/A	N/A	N/A	N/A	168	N/A	N/A	°C/W

(1) For more information about traditional and new thermal metrics, see the [Semiconductor and IC Package Thermal Metrics application report](#).

## 6.5 Electrical Characteristics

over recommended operating free-air temperature range (unless otherwise noted)

PARAMETER	TEST CONDITIONS		V <sub>CC</sub>	MIN	TYP <sup>(1)</sup>	MAX	UNIT
V <sub>OL</sub> High-level output voltage	I <sub>OL</sub> = 100 μA		1.65 V to 5.5 V			0.1	V
	I <sub>OL</sub> = 4 mA		1.65 V			0.45	
	I <sub>OL</sub> = 8 mA		2.3 V			0.3	
	I <sub>OL</sub> = 16 mA		3 V			0.4	
	I <sub>OL</sub> = 24 mA					0.55	
	I <sub>OL</sub> = 32 mA		4.5 V			0.55	
I <sub>I</sub> Inflection- point current	V <sub>I</sub> = 5.5 V or GND	A input	0 to 5.5 V			±1	μA
I <sub>off</sub> Off-state current	V <sub>I</sub> or V <sub>O</sub> = 5.5 V		0			±10	μA
I <sub>CC</sub>	V <sub>I</sub> = 5.5 V or GND, I <sub>O</sub> = 0		1.65 V to 5.5 V			10	μA
ΔI <sub>CC</sub>	One input at V <sub>CC</sub> – 0.6 V, Other inputs at V <sub>CC</sub> or GND		3 V to 5.5 V			500	μA
C <sub>I</sub> Input capacitance	V <sub>I</sub> = V <sub>CC</sub> or GND		3.3 V		4		pF
C <sub>O</sub> Off-state capacitance	V <sub>O</sub> = V <sub>CC</sub> or GND		3.3 V		5		pF

 (1) All typical values are at V<sub>CC</sub> = 3.3 V, T<sub>A</sub> = 25°C.

## 6.6 Switching Characteristics: –40°C to +85°C

 over recommended operating free-air temperature range, T<sub>A</sub> = –40°C to +85°C (unless otherwise noted) (see [Figure 3](#))

PARAMETER	FROM (INPUT)	TO (OUTPUT)	V <sub>CC</sub>	MIN	MAX	UNIT
t <sub>pd</sub> Propagation delay	A	Y	1.8 V ± 0.15 V	2.2	6.5	ns
			2.5 V ± 0.2 V	1.1	4	
			3.3 V ± 0.3 V	1.2	4	
			5 V ± 0.5 V	1	3	

## 6.7 Switching Characteristics: –40°C to +125°C

 over recommended operating free-air temperature range, T<sub>A</sub> = –40°C to +125°C (unless otherwise noted) (see [Figure 3](#))

PARAMETER	FROM (INPUT)	TO (OUTPUT)	V <sub>CC</sub>	MIN	MAX	UNIT
t <sub>pd</sub> Propagation delay	A	Y	1.8 V ± 0.15 V	2.2	7	ns
			2.5 V ± 0.2 V	1.1	4.5	
			3.3 V ± 0.3 V	1.2	4.5	
			5 V ± 0.5 V	1	3.5	

## 6.8 Operating Characteristics

 T<sub>A</sub> = 25°C

PARAMETER	TEST CONDITIONS	V <sub>CC</sub>	TYP	UNIT
C <sub>pd</sub> Power dissipation capacitance	f = 10 MHz	1.8 V	3	pF
		2.5 V	3	
		3.3 V	4	
		5 V	6	

## 6.9 Typical Characteristics

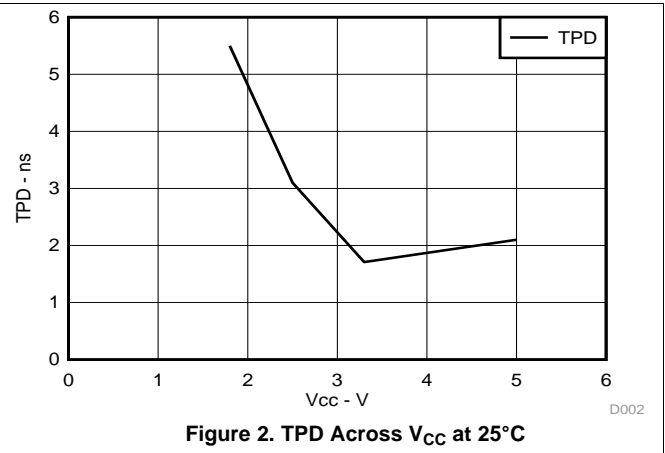
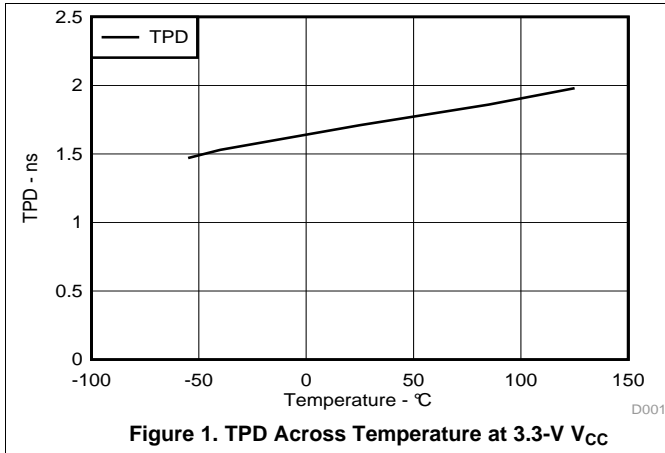

## 7 Parameter Measurement Information

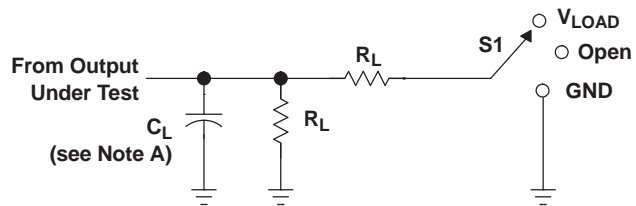
**LOAD CIRCUIT**

TEST	S1
$t_{pZL}$ (see Notes E and F)	$V_{LOAD}$
$t_{pLZ}$ (see Notes E and G)	$V_{LOAD}$
$t_{PHZ}/t_{PZH}$	$V_{LOAD}$

$V_{CC}$	INPUT		$V_M$	$V_{LOAD}$	$C_L$	$R_L$	$V_\Delta$
	$V_I$	$t_r/t_f$					
$1.8\text{ V} \pm 0.15\text{ V}$	$V_{CC}$	$\leq 2\text{ ns}$	$V_{CC}/2$	$2 \times V_{CC}$	30 pF	1 k $\Omega$	0.15 V
$2.5\text{ V} \pm 0.2\text{ V}$	$V_{CC}$	$\leq 2\text{ ns}$	$V_{CC}/2$	$2 \times V_{CC}$	30 pF	500 $\Omega$	0.15 V
$3.3\text{ V} \pm 0.3\text{ V}$	3 V	$\leq 2.5\text{ ns}$	1.5 V	6 V	50 pF	500 $\Omega$	0.3 V
$5\text{ V} \pm 0.5\text{ V}$	$V_{CC}$	$\leq 2.5\text{ ns}$	$V_{CC}/2$	$2 \times V_{CC}$	50 pF	500 $\Omega$	0.3 V

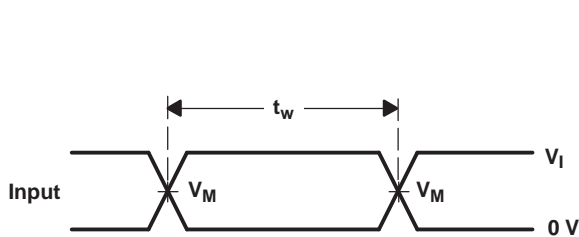
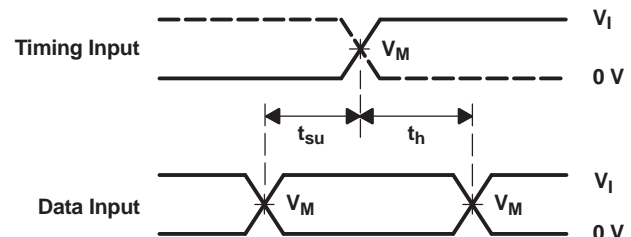
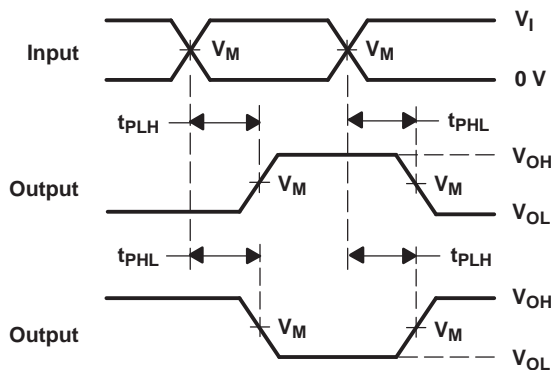
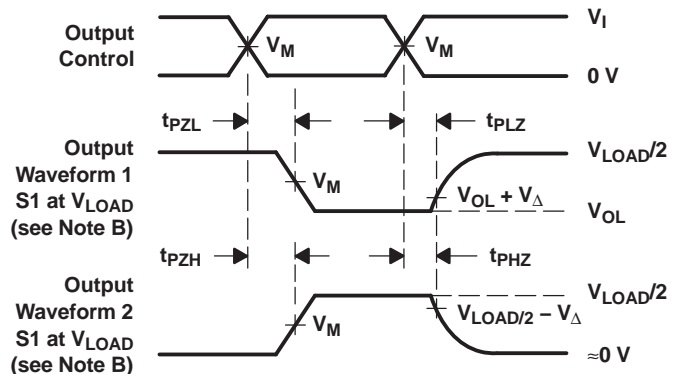
**VOLTAGE WAVEFORMS PULSE DURATION**

**VOLTAGE WAVEFORMS SETUP AND HOLD TIMES**

**VOLTAGE WAVEFORMS PROPAGATION DELAY TIMES INVERTING AND NONINVERTING OUTPUTS**

**VOLTAGE WAVEFORMS ENABLE AND DISABLE TIMES LOW- AND HIGH-LEVEL ENABLING**

- NOTES:
- $C_L$  includes probe and jig capacitance.
  - Waveform 1 is for an output with internal conditions such that the output is low, except when disabled by the output control. Waveform 2 is for an output with internal conditions such that the output is high, except when disabled by the output control.
  - All input pulses are supplied by generators having the following characteristics:  $PRR \leq 10\text{ MHz}$ ,  $Z_O = 50\ \Omega$ .
  - The outputs are measured one at a time, with one transition per measurement.
  - Since this device has open-drain outputs,  $t_{pLZ}$  and  $t_{pZL}$  are the same as  $t_{pd}$ .
  - $t_{pZL}$  is measured at  $V_M$ .
  - $t_{pLZ}$  is measured at  $V_{OL} + V_\Delta$ .
  - All parameters and waveforms are not applicable to all devices.

**Figure 3. Load Circuit and Voltage Waveforms (Open Drain)**

## 8 Detailed Description

### 8.1 Overview

The SN74LVC1G06 device contains one open-drain inverter with a maximum sink current of 32 mA. This device is fully specified for partial-power-down applications using  $I_{off}$ . The  $I_{off}$  circuitry disables the outputs when the device is powered down. This inhibits current backflow into the device which prevents damage to the device.

### 8.2 Functional Block Diagram

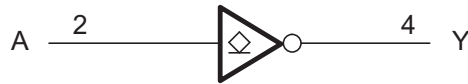

**Figure 4. Logic Diagram (Positive Logic)**

### 8.3 Feature Description

#### 8.3.1 CMOS Open-Drain Outputs

The open-drain output allows the device to sink current to GND but not to source current from  $V_{CC}$ . When the output is not actively pulling the line low, it will go into a high impedance state (tri-state). This allows the device to be used for a wide variety of applications, including up-translation and down-translation, as the output voltage can be determined by an external pullup.

The drive capability of this device creates fast edges into light loads so routing and load conditions should be considered to prevent ringing. Additionally, the outputs of this device are capable of driving larger currents than the device can sustain without being damaged. It is important for the power output of the device to be limited to avoid thermal runaway and damage due to over-current. The electrical and thermal limits defined in the [Absolute Maximum Ratings](#) must be followed at all times.

#### 8.3.2 Standard CMOS Inputs

The impedance for standard CMOS inputs is high. Typically, a CMOS input is modeled as a resistor in parallel with the input capacitance as shown in the [Electrical Characteristics](#). The worst case resistance is calculated with the maximum input voltage, given in the [Absolute Maximum Ratings](#), and the maximum input leakage current, given in the [Electrical Characteristics](#), using ohm's law ( $R = V \div I$ ).

Signals applied to the inputs need to have fast edge rates, as defined by  $\Delta t/\Delta v$  in the [Recommended Operating Conditions](#) to avoid excessive current consumption and oscillations. If a slow or noisy input signal is required, a device with a Schmitt-trigger input should be used to condition the input signal before the standard CMOS input.

**Feature Description (continued)**

**8.3.3 Negative Clamping Diodes**

The inputs and outputs to this device have negative clamping diodes as depicted in [Figure 5](#).

**CAUTION**

Voltages beyond the values specified in the [Absolute Maximum Ratings](#) table can cause damage to the device. The input negative-voltage and the output voltage ratings may be exceeded if the input and output clamp-current ratings are observed.

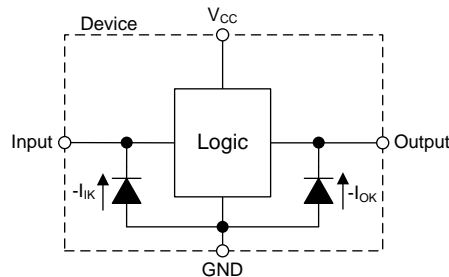

**Figure 5. Electrical Placement of Clamping Diodes for Each Input and Output**

**8.3.4 Partial Power Down ( $I_{off}$ )**

Each input and output enter a high impedance state when the supply voltage is 0 V. The maximum leakage into or out of any input or output pin on the device is specified by  $I_{off}$  in the [Electrical Characteristics](#).

**8.3.5 Over-voltage Tolerant Inputs**

Input signals to this device can be driven above the supply voltage as long as the input signals remain below the maximum input voltage value specified in the [Recommended Operating Conditions](#).

**8.4 Device Functional Modes**

[Table 1](#) lists the functional modes of the SN74LVC1G06.

**Table 1. Function Table**

INPUT A	OUTPUT Y
L	Hi-Z
H	L

## 9 Application and Implementation

### NOTE

Information in the following applications sections is not part of the TI component specification, and TI does not warrant its accuracy or completeness. TI's customers are responsible for determining suitability of components for their purposes. Customers should validate and test their design implementation to confirm system functionality.

### 9.1 Application Information

The SN74LVC1G06 is a high-drive CMOS device that can be used to implement a high output drive buffer, such as an LED application. It can sink 32 mA of current at 4.5 V making it ideal for high-drive applications. It is good for high-speed applications up to 100 MHz. The inputs are 5.5-V tolerant allowing it to translate up or down to  $V_{CC}$ . Below shows a simple LED driver application for a single channel of the device.

### 9.2 Typical Application

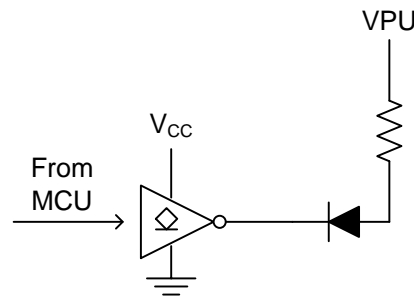

Figure 6. Typical Application Diagram

#### 9.2.1 Design Requirements

This device uses CMOS technology and has balanced output drive. Take care to avoid bus contention because it can drive currents that would exceed maximum limits. The high drive will also create fast edges into light loads so routing and load conditions should be considered to prevent ringing.

#### 9.2.2 Detailed Design Procedure

1. Recommended Input Conditions
  - Rise time and fall time specs. See  $(\Delta t/\Delta V)$  in the [Recommended Operating Conditions](#) table.
  - Specified high and low levels. See  $(V_{IH}$  and  $V_{IL})$  in the [Recommended Operating Conditions](#) table.
  - Inputs are overvoltage tolerant allowing them to go as high as  $(V_I \text{ max})$  in the [Recommended Operating Conditions](#) table at any valid  $V_{CC}$ .
2. Recommended Output Conditions
  - Load currents should not exceed  $(I_O \text{ max})$  per output and should not exceed (Continuous current through  $V_{CC}$  or GND) total current for the part. These limits are located in the [Absolute Maximum Ratings](#) table.
  - Outputs should not be pulled above 5.5 V.

**Typical Application (continued)**

**9.2.3 Application Curve**

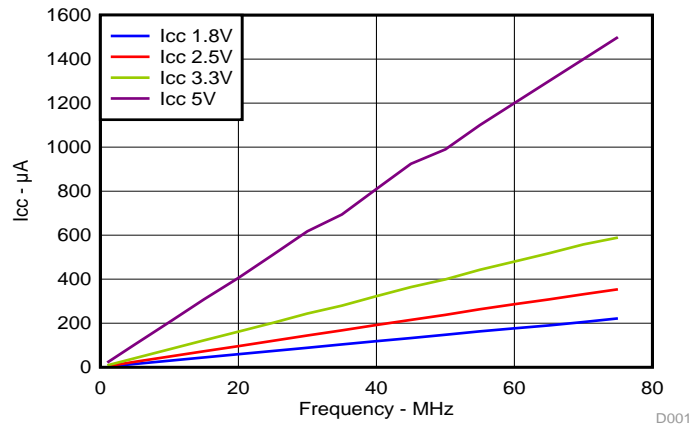

**Figure 7. I<sub>CC</sub> vs Frequency**

## 10 Power Supply Recommendations

The power supply can be any voltage between the minimum and maximum supply voltage rating located in the [Recommended Operating Conditions](#) table.

The  $V_{CC}$  pin must have a good bypass capacitor to prevent power disturbance. A 0.1- $\mu\text{F}$  capacitor is recommended, and it is ok to parallel multiple bypass caps to reject different frequencies of noise. 0.1- $\mu\text{F}$  and 1- $\mu\text{F}$  capacitors are commonly used in parallel. The bypass capacitor must be installed as close to the power pin as possible for best results.

## 11 Layout

### 11.1 Layout Guidelines

Even low data rate digital signals can contain high-frequency signal components due to fast edge rates. When a printed-circuit board (PCB) trace turns a corner at a 90° angle, a reflection can occur. A reflection occurs primarily because of the change of width of the trace. At the apex of the turn, the trace width increases to 1.414 times the width. This increase upsets the transmission-line characteristics, especially the distributed capacitance and self-inductance of the trace which results in the reflection. Not all PCB traces can be straight and therefore some traces must turn corners. [Figure 8](#) shows progressively better techniques of rounding corners. Only the last example (BEST) maintains constant trace width and minimizes reflections.

An example layout is given in [Figure 9](#) for the DPW (X2SON-5) package. This example layout includes a 0402 (metric) capacitor and uses the measurements found in the example board layout appended to this end of this datasheet. A via of diameter 0.1 mm (3.973 mil) is placed directly in the center of the device. This via can be used to trace out the center pin connection through another board layer, or it can be left out of the layout

### 11.2 Layout Example

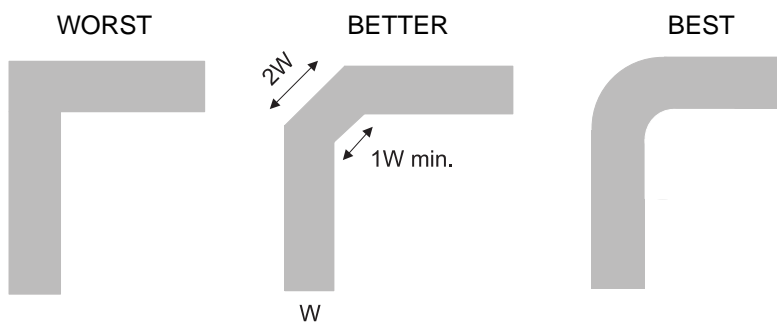

Figure 8. Trace Example

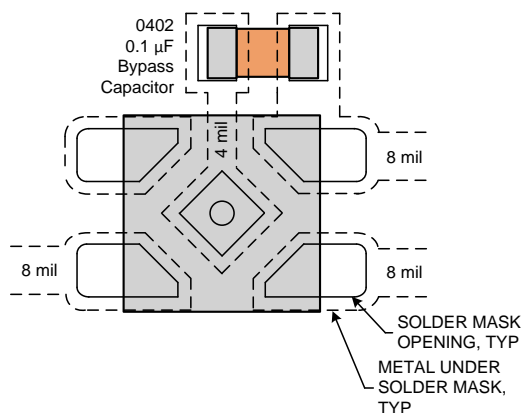

Figure 9. Example Layout With DPW (X2SON-5) Package

## 12 Device and Documentation Support

### 12.1 Receiving Notification of Documentation Updates

To receive notification of documentation updates, navigate to the device product folder on ti.com. In the upper right corner, click on *Alert me* to register and receive a weekly digest of any product information that has changed. For change details, review the revision history included in any revised document.

### 12.2 Community Resources

The following links connect to TI community resources. Linked contents are provided "AS IS" by the respective contributors. They do not constitute TI specifications and do not necessarily reflect TI's views; see TI's [Terms of Use](#).

**TI E2E™ Online Community** *TI's Engineer-to-Engineer (E2E) Community*. Created to foster collaboration among engineers. At e2e.ti.com, you can ask questions, share knowledge, explore ideas and help solve problems with fellow engineers.

**Design Support** *TI's Design Support* Quickly find helpful E2E forums along with design support tools and contact information for technical support.

### 12.3 Trademarks

NanoFree, E2E are trademarks of Texas Instruments.  
All other trademarks are the property of their respective owners.

### 12.4 Electrostatic Discharge Caution



These devices have limited built-in ESD protection. The leads should be shorted together or the device placed in conductive foam during storage or handling to prevent electrostatic damage to the MOS gates.

### 12.5 Glossary

[SLYZ022](#) — *TI Glossary*.

This glossary lists and explains terms, acronyms, and definitions.

## 13 Mechanical, Packaging, and Orderable Information

The following pages include mechanical packaging and orderable information. This information is the most current data available for the designated devices. This data is subject to change without notice and revision of this document. For browser based versions of this data sheet, refer to the left hand navigation.

**PACKAGING INFORMATION**

Orderable Device	Status (1)	Package Type	Package Drawing	Pins	Package Qty	Eco Plan (2)	Lead/Ball Finish (6)	MSL Peak Temp (3)	Op Temp (°C)	Device Marking (4/5)	Samples
SN74LVC1G06DBVR	ACTIVE	SOT-23	DBV	5	3000	Green (RoHS & no Sb/Br)	CU NIPDAU   CU SN	Level-1-260C-UNLIM	-40 to 125	(C065, C06F, C06J, C06R, C06T) (C06H, C06P, C06S)	<a href="#">Samples</a>
SN74LVC1G06DBVRE4	ACTIVE	SOT-23	DBV	5	3000	Green (RoHS & no Sb/Br)	CU NIPDAU	Level-1-260C-UNLIM	-40 to 125	C06F	<a href="#">Samples</a>
SN74LVC1G06DBVRG4	ACTIVE	SOT-23	DBV	5	3000	Green (RoHS & no Sb/Br)	CU NIPDAU	Level-1-260C-UNLIM	-40 to 125	C06F	<a href="#">Samples</a>
SN74LVC1G06DBVT	ACTIVE	SOT-23	DBV	5	250	Green (RoHS & no Sb/Br)	CU NIPDAU   CU SN	Level-1-260C-UNLIM	-40 to 125	(C065, C06F, C06J, C06R) (C06H, C06P, C06S)	<a href="#">Samples</a>
SN74LVC1G06DBVTG4	ACTIVE	SOT-23	DBV	5	250	Green (RoHS & no Sb/Br)	CU NIPDAU	Level-1-260C-UNLIM	-40 to 125	C06F	<a href="#">Samples</a>
SN74LVC1G06DCKR	ACTIVE	SC70	DCK	5	3000	Green (RoHS & no Sb/Br)	CU NIPDAU	Level-1-260C-UNLIM	-40 to 125	(CT5, CTF, CTK, CT R, CTT) (CTH, CTS)	<a href="#">Samples</a>
SN74LVC1G06DCKRE4	ACTIVE	SC70	DCK	5	3000	Green (RoHS & no Sb/Br)	CU NIPDAU	Level-1-260C-UNLIM	-40 to 125	(CT5, CTF, CTK, CT R, CTT) (CTH, CTS)	<a href="#">Samples</a>
SN74LVC1G06DCKRG4	ACTIVE	SC70	DCK	5	3000	Green (RoHS & no Sb/Br)	CU NIPDAU	Level-1-260C-UNLIM	-40 to 125	(CT5, CTF, CTK, CT R, CTT) (CTH, CTS)	<a href="#">Samples</a>
SN74LVC1G06DCKT	ACTIVE	SC70	DCK	5	250	Green (RoHS & no Sb/Br)	CU NIPDAU	Level-1-260C-UNLIM	-40 to 125	(CT5, CTF, CTK, CT R) (CTH, CTS)	<a href="#">Samples</a>
SN74LVC1G06DCKTE4	ACTIVE	SC70	DCK	5	250	Green (RoHS & no Sb/Br)	CU NIPDAU	Level-1-260C-UNLIM	-40 to 125	(CT5, CTF, CTK, CT R) (CTH, CTS)	<a href="#">Samples</a>
SN74LVC1G06DCKTG4	ACTIVE	SC70	DCK	5	250	Green (RoHS & no Sb/Br)	CU NIPDAU	Level-1-260C-UNLIM	-40 to 125	(CT5, CTF, CTK, CT R) (CTH, CTS)	<a href="#">Samples</a>
SN74LVC1G06DPWR	ACTIVE	X2SON	DPW	5	3000	Green (RoHS & no Sb/Br)	CU NIPDAU	Level-1-260C-UNLIM	-40 to 85	CO	<a href="#">Samples</a>
SN74LVC1G06DRLR	ACTIVE	SOT-5X3	DRL	5	4000	Green (RoHS & no Sb/Br)	CU NIPDAU   CU NIPDAUAG	Level-1-260C-UNLIM	-40 to 125	(CT7, CTR)	<a href="#">Samples</a>

Orderable Device	Status (1)	Package Type	Package Drawing	Pins	Package Qty	Eco Plan (2)	Lead/Ball Finish (6)	MSL Peak Temp (3)	Op Temp (°C)	Device Marking (4/5)	Samples
SN74LVC1G06DRYR	ACTIVE	SON	DRY	6	5000	Green (RoHS & no Sb/Br)	CU NIPDAU	Level-1-260C-UNLIM	-40 to 125	CT	<a href="#">Samples</a>
SN74LVC1G06DSFR	ACTIVE	SON	DSF	6	5000	Green (RoHS & no Sb/Br)	CU NIPDAU   CU NIPDAUAG	Level-1-260C-UNLIM	-40 to 125	CT	<a href="#">Samples</a>
SN74LVC1G06YZPR	ACTIVE	DSBGA	YZP	5	3000	Green (RoHS & no Sb/Br)	SNAGCU	Level-1-260C-UNLIM	-40 to 85	CTN	<a href="#">Samples</a>
SN74LVC1G06YZVR	ACTIVE	DSBGA	YZV	4	3000	Green (RoHS & no Sb/Br)	SNAGCU	Level-1-260C-UNLIM	-40 to 85	CT N	<a href="#">Samples</a>

(1) The marketing status values are defined as follows:

**ACTIVE:** Product device recommended for new designs.

**LIFEBUY:** TI has announced that the device will be discontinued, and a lifetime-buy period is in effect.

**NRND:** Not recommended for new designs. Device is in production to support existing customers, but TI does not recommend using this part in a new design.

**PREVIEW:** Device has been announced but is not in production. Samples may or may not be available.

**OBSOLETE:** TI has discontinued the production of the device.

(2) **RoHS:** TI defines "RoHS" to mean semiconductor products that are compliant with the current EU RoHS requirements for all 10 RoHS substances, including the requirement that RoHS substance do not exceed 0.1% by weight in homogeneous materials. Where designed to be soldered at high temperatures, "RoHS" products are suitable for use in specified lead-free processes. TI may reference these types of products as "Pb-Free".

**RoHS Exempt:** TI defines "RoHS Exempt" to mean products that contain lead but are compliant with EU RoHS pursuant to a specific EU RoHS exemption.

**Green:** TI defines "Green" to mean the content of Chlorine (Cl) and Bromine (Br) based flame retardants meet JS709B low halogen requirements of <=1000ppm threshold. Antimony trioxide based flame retardants must also meet the <=1000ppm threshold requirement.

(3) MSL, Peak Temp. - The Moisture Sensitivity Level rating according to the JEDEC industry standard classifications, and peak solder temperature.

(4) There may be additional marking, which relates to the logo, the lot trace code information, or the environmental category on the device.

(5) Multiple Device Markings will be inside parentheses. Only one Device Marking contained in parentheses and separated by a "~" will appear on a device. If a line is indented then it is a continuation of the previous line and the two combined represent the entire Device Marking for that device.

(6) Lead/Ball Finish - Orderable Devices may have multiple material finish options. Finish options are separated by a vertical ruled line. Lead/Ball Finish values may wrap to two lines if the finish value exceeds the maximum column width.

**Important Information and Disclaimer:** The information provided on this page represents TI's knowledge and belief as of the date that it is provided. TI bases its knowledge and belief on information provided by third parties, and makes no representation or warranty as to the accuracy of such information. Efforts are underway to better integrate information from third parties. TI has taken and continues to take reasonable steps to provide representative and accurate information but may not have conducted destructive testing or chemical analysis on incoming materials and chemicals. TI and TI suppliers consider certain information to be proprietary, and thus CAS numbers and other limited information may not be available for release.

In no event shall TI's liability arising out of such information exceed the total purchase price of the TI part(s) at issue in this document sold by TI to Customer on an annual basis.

**OTHER QUALIFIED VERSIONS OF SN74LVC1G06 :**

- Enhanced Product: [SN74LVC1G06-EP](#)

**NOTE: Qualified Version Definitions:**

- Enhanced Product - Supports Defense, Aerospace and Medical Applications

## TAPE AND REEL INFORMATION



### QUADRANT ASSIGNMENTS FOR PIN 1 ORIENTATION IN TAPE



\*All dimensions are nominal

Device	Package Type	Package Drawing	Pins	SPQ	Reel Diameter (mm)	Reel Width W1 (mm)	A0 (mm)	B0 (mm)	K0 (mm)	P1 (mm)	W (mm)	Pin1 Quadrant
SN74LVC1G06DBVR	SOT-23	DBV	5	3000	178.0	9.0	3.3	3.2	1.4	4.0	8.0	Q3
SN74LVC1G06DBVR	SOT-23	DBV	5	3000	178.0	9.2	3.3	3.23	1.55	4.0	8.0	Q3
SN74LVC1G06DBVR	SOT-23	DBV	5	3000	178.0	9.0	3.23	3.17	1.37	4.0	8.0	Q3
SN74LVC1G06DBVR	SOT-23	DBV	5	3000	180.0	8.4	3.23	3.17	1.37	4.0	8.0	Q3
SN74LVC1G06DBVRG4	SOT-23	DBV	5	3000	178.0	9.0	3.23	3.17	1.37	4.0	8.0	Q3
SN74LVC1G06DBVT	SOT-23	DBV	5	250	178.0	9.0	3.23	3.17	1.37	4.0	8.0	Q3
SN74LVC1G06DBVT	SOT-23	DBV	5	250	180.0	8.4	3.23	3.17	1.37	4.0	8.0	Q3
SN74LVC1G06DBVT	SOT-23	DBV	5	250	178.0	9.0	3.3	3.2	1.4	4.0	8.0	Q3
SN74LVC1G06DBVT	SOT-23	DBV	5	250	178.0	9.2	3.3	3.23	1.55	4.0	8.0	Q3
SN74LVC1G06DBVTG4	SOT-23	DBV	5	250	178.0	9.0	3.23	3.17	1.37	4.0	8.0	Q3
SN74LVC1G06DCKR	SC70	DCK	5	3000	178.0	9.2	2.4	2.4	1.22	4.0	8.0	Q3
SN74LVC1G06DCKR	SC70	DCK	5	3000	178.0	9.0	2.4	2.5	1.2	4.0	8.0	Q3
SN74LVC1G06DCKT	SC70	DCK	5	250	178.0	9.2	2.4	2.4	1.22	4.0	8.0	Q3
SN74LVC1G06DCKT	SC70	DCK	5	250	180.0	9.2	2.3	2.55	1.2	4.0	8.0	Q3
SN74LVC1G06DPWR	X2SON	DPW	5	3000	178.0	8.4	0.91	0.91	0.5	2.0	8.0	Q3
SN74LVC1G06DRLR	SOT-5X3	DRL	5	4000	180.0	9.5	1.78	1.78	0.69	4.0	8.0	Q3
SN74LVC1G06DRLR	SOT-5X3	DRL	5	4000	180.0	8.4	1.98	1.78	0.69	4.0	8.0	Q3
SN74LVC1G06DRYR	SON	DRY	6	5000	180.0	9.5	1.15	1.6	0.75	4.0	8.0	Q1

Device	Package Type	Package Drawing	Pins	SPQ	Reel Diameter (mm)	Reel Width W1 (mm)	A0 (mm)	B0 (mm)	K0 (mm)	P1 (mm)	W (mm)	Pin1 Quadrant
SN74LVC1G06DSFR	SON	DSF	6	5000	180.0	9.5	1.16	1.16	0.5	4.0	8.0	Q2
SN74LVC1G06YZPR	DSBGA	YZP	5	3000	178.0	9.2	1.02	1.52	0.63	4.0	8.0	Q1
SN74LVC1G06YZVR	DSBGA	YZV	4	3000	178.0	9.2	1.0	1.0	0.63	4.0	8.0	Q1

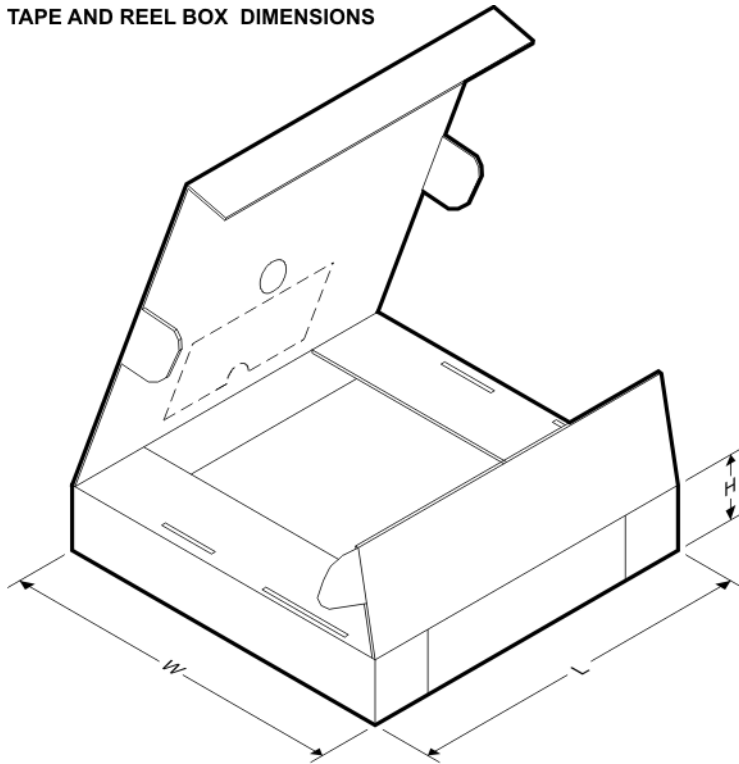
**TAPE AND REEL BOX DIMENSIONS**

\*All dimensions are nominal

Device	Package Type	Package Drawing	Pins	SPQ	Length (mm)	Width (mm)	Height (mm)
SN74LVC1G06DBVR	SOT-23	DBV	5	3000	180.0	180.0	18.0
SN74LVC1G06DBVR	SOT-23	DBV	5	3000	180.0	180.0	18.0
SN74LVC1G06DBVR	SOT-23	DBV	5	3000	180.0	180.0	18.0
SN74LVC1G06DBVR	SOT-23	DBV	5	3000	202.0	201.0	28.0
SN74LVC1G06DBVRG4	SOT-23	DBV	5	3000	180.0	180.0	18.0
SN74LVC1G06DBVT	SOT-23	DBV	5	250	180.0	180.0	18.0
SN74LVC1G06DBVT	SOT-23	DBV	5	250	202.0	201.0	28.0
SN74LVC1G06DBVT	SOT-23	DBV	5	250	180.0	180.0	18.0
SN74LVC1G06DBVT	SOT-23	DBV	5	250	180.0	180.0	18.0
SN74LVC1G06DBVTG4	SOT-23	DBV	5	250	180.0	180.0	18.0
SN74LVC1G06DCKR	SC70	DCK	5	3000	180.0	180.0	18.0
SN74LVC1G06DCKR	SC70	DCK	5	3000	180.0	180.0	18.0
SN74LVC1G06DCKT	SC70	DCK	5	250	180.0	180.0	18.0
SN74LVC1G06DCKT	SC70	DCK	5	250	205.0	200.0	33.0

---

Device	Package Type	Package Drawing	Pins	SPQ	Length (mm)	Width (mm)	Height (mm)
SN74LVC1G06DPWR	X2SON	DPW	5	3000	205.0	200.0	33.0
SN74LVC1G06DRLR	SOT-5X3	DRL	5	4000	184.0	184.0	19.0
SN74LVC1G06DRLR	SOT-5X3	DRL	5	4000	202.0	201.0	28.0
SN74LVC1G06DRYR	SON	DRY	6	5000	184.0	184.0	19.0
SN74LVC1G06DSFR	SON	DSF	6	5000	184.0	184.0	19.0
SN74LVC1G06YZPR	DSBGA	YZP	5	3000	220.0	220.0	35.0
SN74LVC1G06YZVR	DSBGA	YZV	4	3000	220.0	220.0	35.0

DCK (R-PDSO-G5)

PLASTIC SMALL-OUTLINE PACKAGE



- NOTES:
- A. All linear dimensions are in millimeters.
  - B. This drawing is subject to change without notice.
  - C. Body dimensions do not include mold flash or protrusion. Mold flash and protrusion shall not exceed 0.15 per side.
  - D. Falls within JEDEC MO-203 variation AA.

DCK (R-PDSO-G5)

PLASTIC SMALL OUTLINE



- NOTES:
- A. All linear dimensions are in millimeters.
  - B. This drawing is subject to change without notice.
  - C. Customers should place a note on the circuit board fabrication drawing not to alter the center solder mask defined pad.
  - D. Publication IPC-7351 is recommended for alternate designs.
  - E. Laser cutting apertures with trapezoidal walls and also rounding corners will offer better paste release. Customers should contact their board assembly site for stencil design recommendations. Example stencil design based on a 50% volumetric metal load solder paste. Refer to IPC-7525 for other stencil recommendations.

## GENERIC PACKAGE VIEW

**DRY 6**

**USON - 0.6 mm max height**

PLASTIC SMALL OUTLINE - NO LEAD



Images above are just a representation of the package family, actual package may vary.  
Refer to the product data sheet for package details.

4207181/G

DRY0006A



# PACKAGE OUTLINE

USON - 0.6 mm max height

PLASTIC SMALL OUTLINE - NO LEAD



NOTES:

1. All linear dimensions are in millimeters. Any dimensions in parenthesis are for reference only. Dimensioning and tolerancing per ASME Y14.5M.
2. This drawing is subject to change without notice.

# EXAMPLE BOARD LAYOUT

DRY0006A

USON - 0.6 mm max height

PLASTIC SMALL OUTLINE - NO LEAD



**LAND PATTERN EXAMPLE**  
1:1 RATIO WITH PKG SOLDER PADS  
EXPOSED METAL SHOWN  
SCALE:40X



**SOLDER MASK DETAILS**

4222894/A 01/2018

NOTES: (continued)

3. For more information, see QFN/SON PCB application report in literature No. SLUA271 ([www.ti.com/lit/slue271](http://www.ti.com/lit/slue271)).

# EXAMPLE STENCIL DESIGN

DRY0006A

USON - 0.6 mm max height

PLASTIC SMALL OUTLINE - NO LEAD



SOLDER PASTE EXAMPLE  
BASED ON 0.075 - 0.1 mm THICK STENCIL  
SCALE:40X

4222894/A 01/2018

NOTES: (continued)

4. Laser cutting apertures with trapezoidal walls and rounded corners may offer better paste release. IPC-7525 may have alternate design recommendations.

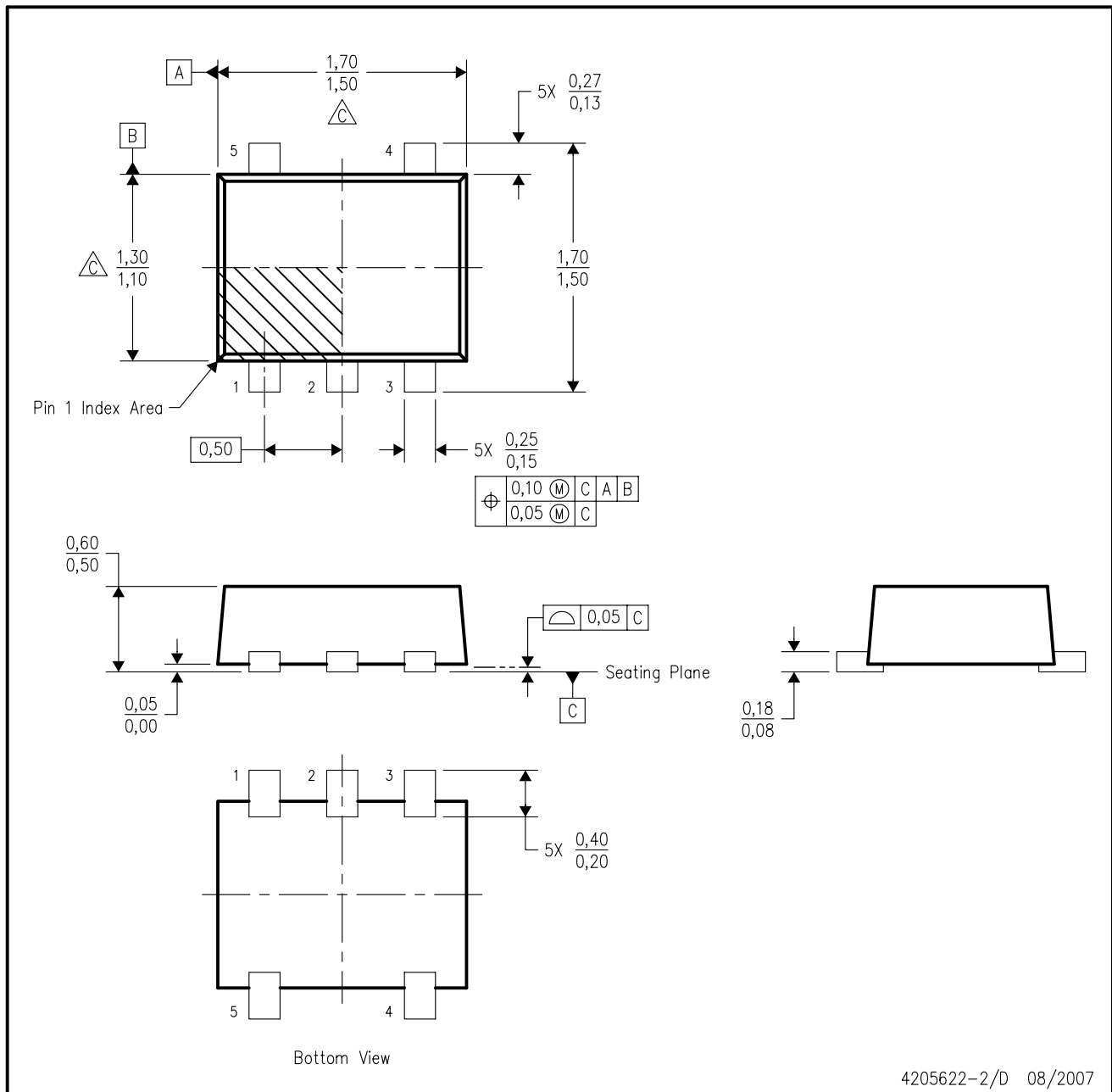

- NOTES:
- A. All linear dimensions are in millimeters. Dimensioning and tolerancing per ASME Y14.5M-1994.
  - B. This drawing is subject to change without notice.
  - C. Body dimensions do not include mold flash, interlead flash, protrusions, or gate burrs. Mold flash, interlead flash, protrusions, or gate burrs shall not exceed 0,15 per end or side.
  - D. JEDEC package registration is pending.

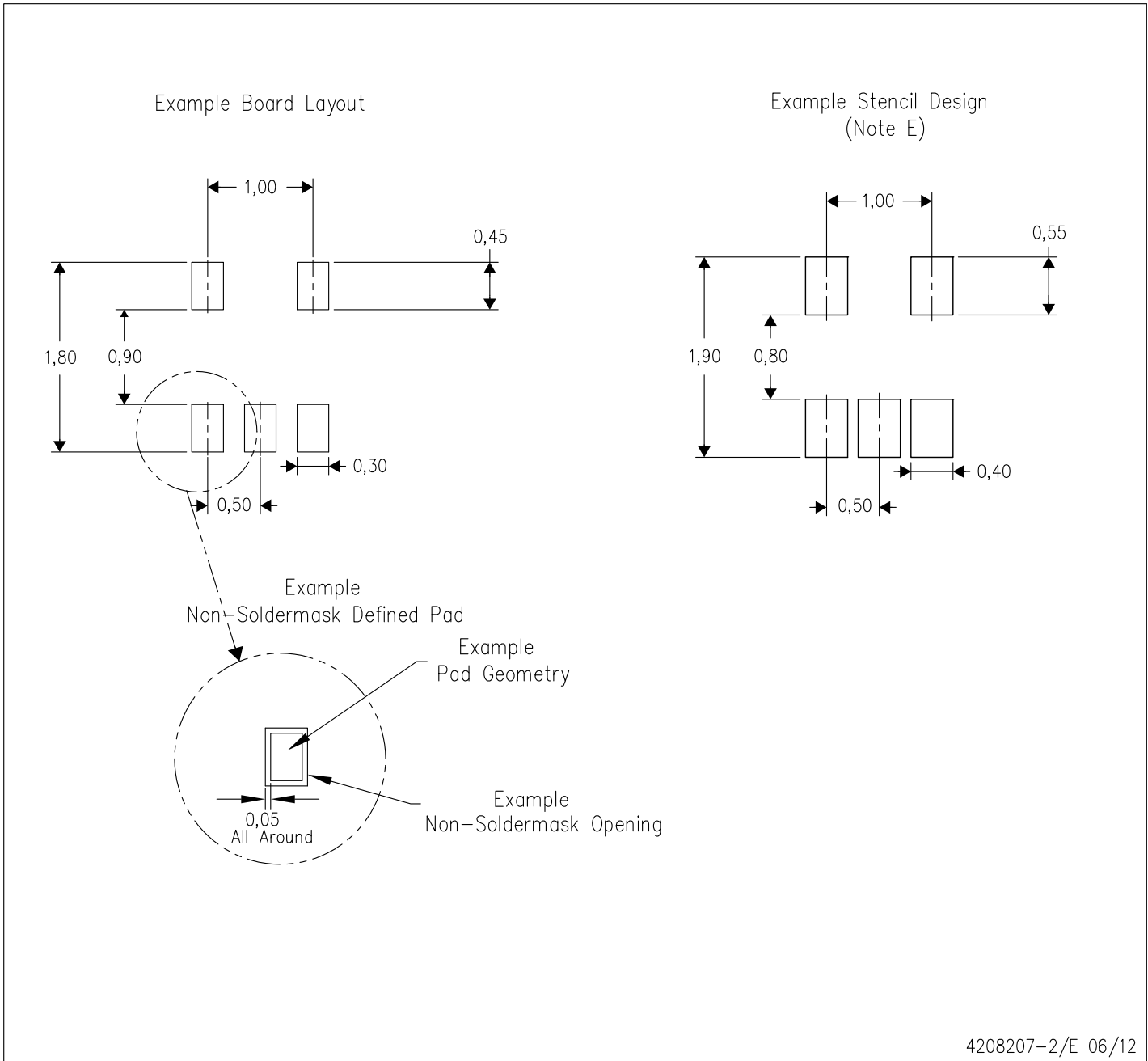

- NOTES:
- A. All linear dimensions are in millimeters.
  - B. This drawing is subject to change without notice.
  - C. Publication IPC-7351 is recommended for alternate designs.
  - D. Customers should contact their board fabrication site for minimum solder mask web tolerances between signal pads.
  - E. Maximum stencil thickness 0,127 mm (5 mils). All linear dimensions are in millimeters.
  - F. Laser cutting apertures with trapezoidal walls and also rounding corners will offer better paste release. Customers should contact their board assembly site for stencil design recommendations. Refer to IPC 7525 for stencil design considerations.
  - G. Side aperture dimensions over-print land for acceptable area ratio > 0.66. Customer may reduce side aperture dimensions if stencil manufacturing process allows for sufficient release at smaller opening.



# EXAMPLE BOARD LAYOUT

DSF0006A

X2SON - 0.4 mm max height

PLASTIC SMALL OUTLINE - NO LEAD

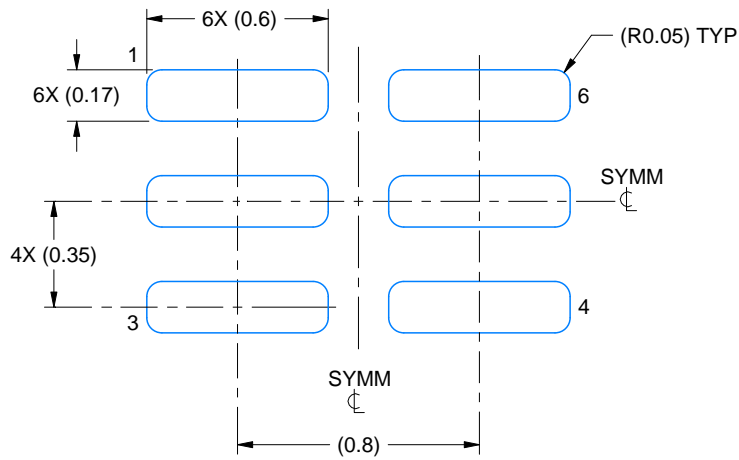

LAND PATTERN EXAMPLE  
EXPOSED METAL SHOWN  
SCALE:40X

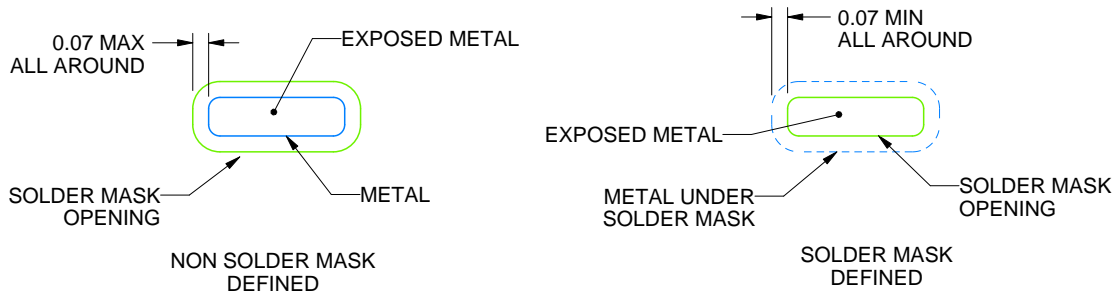

SOLDER MASK DETAILS

4220597/A 06/2017

NOTES: (continued)

4. For more information, see Texas Instruments literature number SLUA271 ([www.ti.com/lit/slua271](http://www.ti.com/lit/slua271)).

# EXAMPLE STENCIL DESIGN

DSF0006A

X2SON - 0.4 mm max height

PLASTIC SMALL OUTLINE - NO LEAD

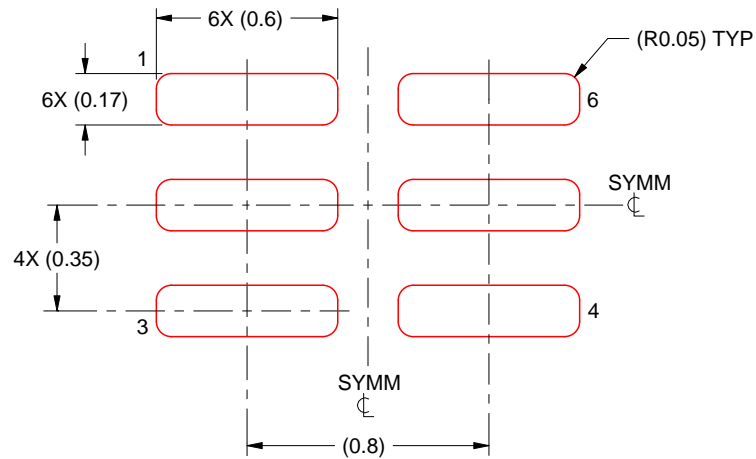

SOLDER PASTE EXAMPLE  
BASED ON 0.125 mm THICK STENCIL  
PRINTED SOLDER COVERAGE BY AREA UNDER PACKAGE  
SCALE:40X

4220597/A 06/2017

4. Laser cutting apertures with trapezoidal walls and rounded corners may offer better paste release. IPC-7525 may have alternate design recommendations.



# EXAMPLE BOARD LAYOUT

DBV0005A

SOT-23 - 1.45 mm max height

SMALL OUTLINE TRANSISTOR



LAND PATTERN EXAMPLE  
EXPOSED METAL SHOWN  
SCALE:15X



SOLDER MASK DETAILS

4214839/D 11/2018

NOTES: (continued)

- 5. Publication IPC-7351 may have alternate designs.
- 6. Solder mask tolerances between and around signal pads can vary based on board fabrication site.



## GENERIC PACKAGE VIEW

DPW 5

X2SON - 0.4 mm max height

PLASTIC SMALL OUTLINE - NO LEAD



Images above are just a representation of the package family, actual package may vary.  
Refer to the product data sheet for package details.

4211218-3/D

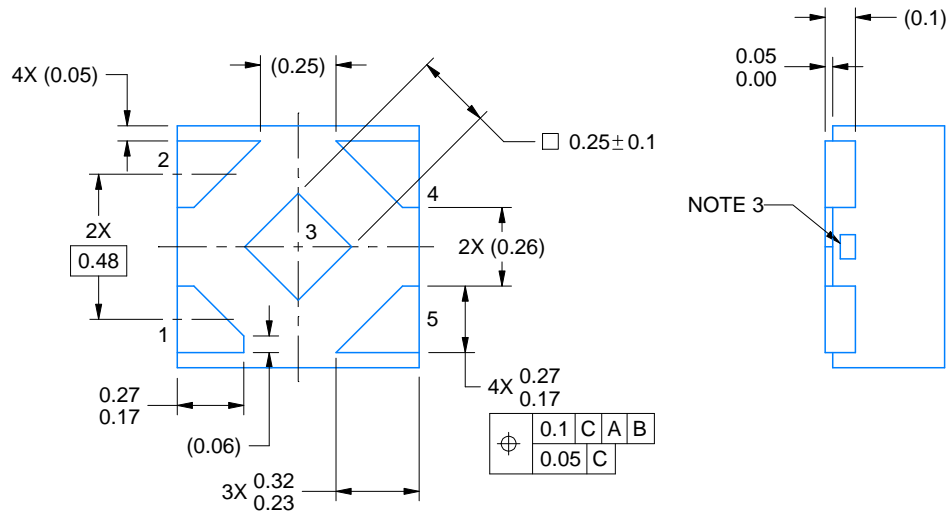
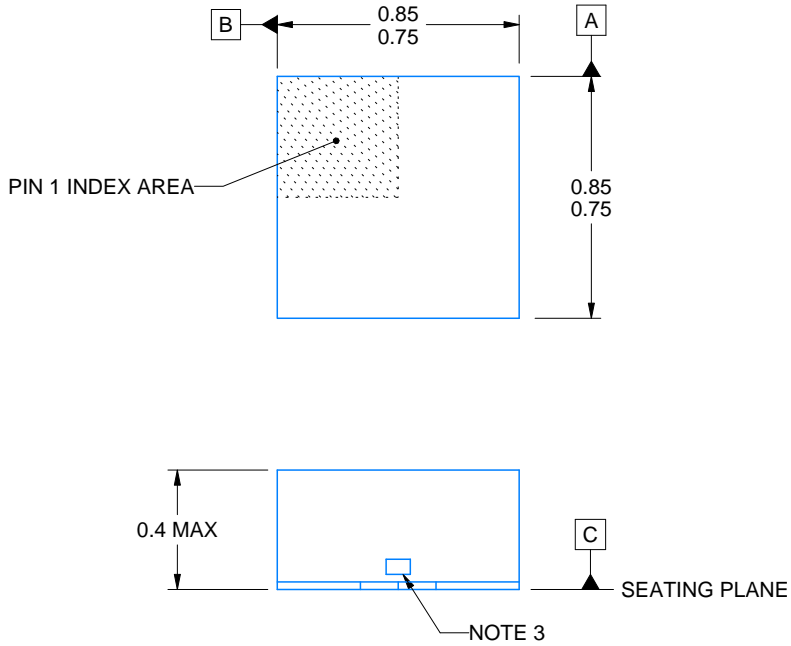
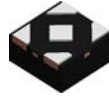

4223102/B 09/2017

NOTES:

1. All linear dimensions are in millimeters. Any dimensions in parenthesis are for reference only. Dimensioning and tolerancing per ASME Y14.5M.
2. This drawing is subject to change without notice.
3. The size and shape of this feature may vary.







# EXAMPLE BOARD LAYOUT

YZP0005

DSBGA - 0.5 mm max height

DIE SIZE BALL GRID ARRAY



LAND PATTERN EXAMPLE  
SCALE:40X



SOLDER MASK DETAILS  
NOT TO SCALE

4219492/A 05/2017

NOTES: (continued)

3. Final dimensions may vary due to manufacturing tolerance considerations and also routing constraints. For more information, see Texas Instruments literature number SNVA009 ([www.ti.com/lit/snva009](http://www.ti.com/lit/snva009)).

# EXAMPLE STENCIL DESIGN

YZP0005

DSBGA - 0.5 mm max height

DIE SIZE BALL GRID ARRAY



SOLDER PASTE EXAMPLE  
BASED ON 0.1 mm THICK STENCIL  
SCALE:40X

4219492/A 05/2017

NOTES: (continued)

4. Laser cutting apertures with trapezoidal walls and rounded corners may offer better paste release.

YZV (S-XBGA-N4)

DIE-SIZE BALL GRID ARRAY

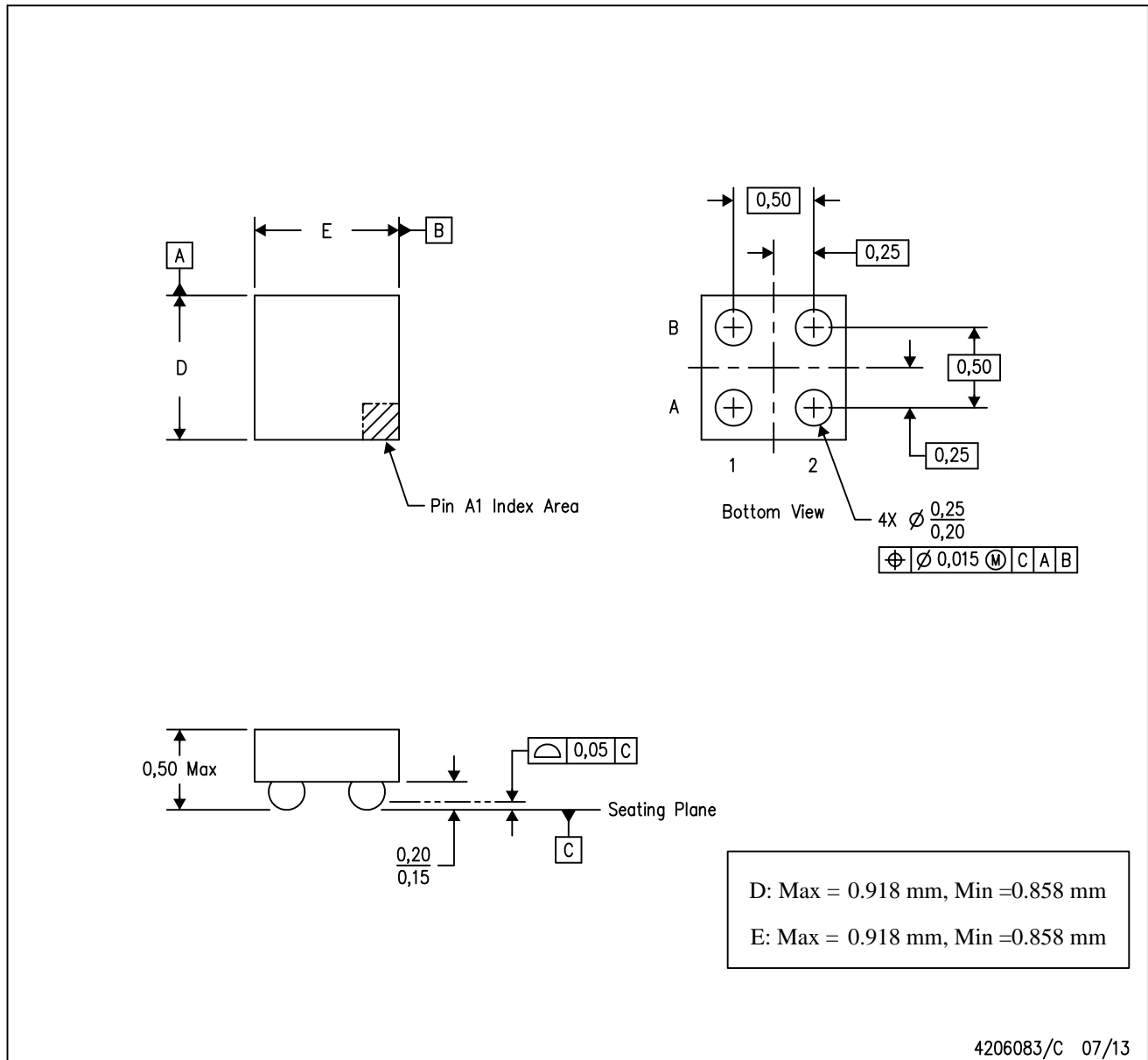

- NOTES:
- A. All linear dimensions are in millimeters. Dimensioning and tolerancing per ASME Y14.5M-1994.
  - B. This drawing is subject to change without notice.
  - C. NanoFree™ package configuration.

NanoFree is a trademark of Texas Instruments.

## IMPORTANT NOTICE AND DISCLAIMER

TI PROVIDES TECHNICAL AND RELIABILITY DATA (INCLUDING DATASHEETS), DESIGN RESOURCES (INCLUDING REFERENCE DESIGNS), APPLICATION OR OTHER DESIGN ADVICE, WEB TOOLS, SAFETY INFORMATION, AND OTHER RESOURCES "AS IS" AND WITH ALL FAULTS, AND DISCLAIMS ALL WARRANTIES, EXPRESS AND IMPLIED, INCLUDING WITHOUT LIMITATION ANY IMPLIED WARRANTIES OF MERCHANTABILITY, FITNESS FOR A PARTICULAR PURPOSE OR NON-INFRINGEMENT OF THIRD PARTY INTELLECTUAL PROPERTY RIGHTS.

These resources are intended for skilled developers designing with TI products. You are solely responsible for (1) selecting the appropriate TI products for your application, (2) designing, validating and testing your application, and (3) ensuring your application meets applicable standards, and any other safety, security, or other requirements. These resources are subject to change without notice. TI grants you permission to use these resources only for development of an application that uses the TI products described in the resource. Other reproduction and display of these resources is prohibited. No license is granted to any other TI intellectual property right or to any third party intellectual property right. TI disclaims responsibility for, and you will fully indemnify TI and its representatives against, any claims, damages, costs, losses, and liabilities arising out of your use of these resources.

TI's products are provided subject to TI's Terms of Sale ([www.ti.com/legal/termsofsale.html](http://www.ti.com/legal/termsofsale.html)) or other applicable terms available either on [ti.com](http://ti.com) or provided in conjunction with such TI products. TI's provision of these resources does not expand or otherwise alter TI's applicable warranties or warranty disclaimers for TI products.

Mailing Address: Texas Instruments, Post Office Box 655303, Dallas, Texas 75265  
Copyright © 2019, Texas Instruments Incorporated

## Looking for pricing, stock, or lifecycle information?

Click below to explore more details on WIN SOURCE:

 [View SN74LVC1G06DBVT on WIN SOURCE](#)

 [Texas Instruments](#) Information

## Optimize Your Supply Chain with WIN SOURCE Solutions

-  Global Sourcing Solution
-  Obsolete Management
-  Cost Control Management
-  Shortage Management
-  Alternative Solution
-  Excess Inventory Management