



**THE DATASHEET OF
TPS62150ARGTT**



TPS6215x 3-V to 17-V, 1-A Step-Down Converter in 3-mm x 3-mm QFN Package

1 Features

- DCS-Control™ Topology
- Input Voltage Range: 3 V to 17 V
- Up to 1-A Output Current
- Adjustable Output Voltage From 0.9 V to 6 V
- Pin-Selectable Output Voltage (nominal, + 5%)
- Programmable Soft Start and Tracking
- Seamless Power-Save Mode Transition
- Quiescent Current of 17 μ A (typ.)
- Selectable Operating Frequency
- Power-Good Output
- 100% Duty-Cycle Mode
- Short-Circuit Protection
- Overtemperature Protection
- Pin to Pin Compatible with [TPS62130](#) and [TPS62140](#)
- Available in a 3-mm x 3-mm, VQFN-16 Package

2 Applications

- Standard 12-V Rail Supplies
- POL Supply From Single or Multiple Li-Ion Battery
- Solid-State Disk Drives
- Embedded Systems
- LDO Replacement
- Mobile PCs, Tablets, Modems, Cameras
- Server, Microserver
- Data Terminal, Point of Sales (ePOS)

3 Description

The TPS6215x family is an easy-to-use synchronous step down dc-dc converter optimized for applications with high power density. A high switching frequency of typically 2.5 MHz allows the use of small inductors and provides fast transient response as well as high output-voltage accuracy by the use of DCS-Control topology.

With their wide operating input-voltage range of 3 V to 17 V, the devices are ideally suited for systems powered from either Li-Ion or other batteries as well as from 12-V intermediate power rails. The devices support up to 1-A continuous output current at output voltages between 0.9 V and 6 V (in 100% duty-cycle mode). The soft-start pin controls the output-voltage start-up ramp, which allows operation as either a standalone power supply or in tracking configurations. Power sequencing is also possible by configuring the enable (EN) and open-drain power-good (PG) pins.

In power-save mode, the devices draw quiescent current of about 17 μ A from VIN. Power-save-mode, entered automatically and seamlessly if the load is small, maintains high efficiency over the entire load range. In shutdown mode, the device turns off and current consumption is less than 2 μ A.

The device, available in adjustable- and fixed-output-voltage versions, comes in a 16-pin VQFN package measuring 3 x 3 mm (RGT).

Device Information⁽¹⁾

| PART NUMBER | PACKAGE | BODY SIZE (NOM) |
|-------------|-----------|-------------------|
| TPS6215X | VQFN (16) | 3.00 mm x 3.00 mm |

(1) For all available packages, see the orderable addendum at the end of the data sheet.

Typical Application Schematic

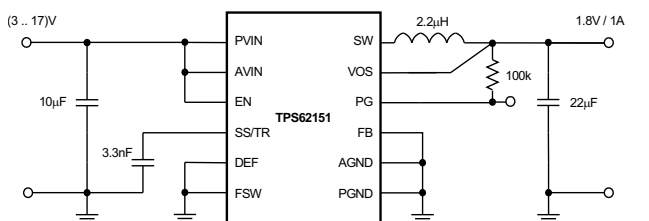

Copyright © 2016, Texas Instruments Incorporated

Efficiency vs Output Current

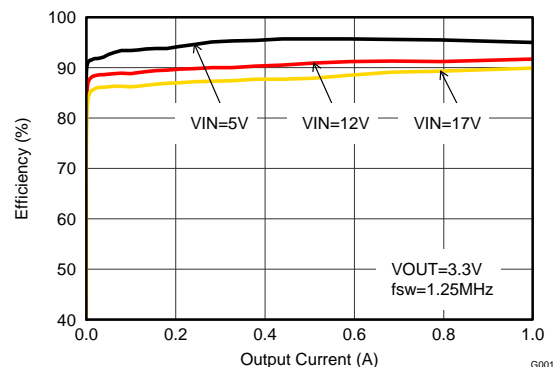

G001



Table of Contents

| | | | |
|--|-----------|--|-----------|
| 1 Features | 1 | 9.1 Application Information..... | 13 |
| 2 Applications | 1 | 9.2 Typical Application | 13 |
| 3 Description | 1 | 9.3 System Examples | 25 |
| 4 Revision History | 2 | 10 Power Supply Recommendations | 28 |
| 5 Device Comparison Table | 4 | 11 Layout | 29 |
| 6 Pin Configuration and Functions | 4 | 11.1 Layout Guidelines | 29 |
| 7 Specifications | 5 | 11.2 Layout Example | 29 |
| 7.1 Absolute Maximum Ratings | 5 | 11.3 Thermal Considerations | 30 |
| 7.2 ESD Ratings | 5 | 12 Device and Documentation Support | 31 |
| 7.3 Recommended Operating Conditions..... | 5 | 12.1 Device Support..... | 31 |
| 7.4 Thermal Information | 5 | 12.2 Documentation Support | 31 |
| 7.5 Electrical Characteristics..... | 6 | 12.3 Related Links | 31 |
| 7.6 Typical Characteristics..... | 7 | 12.4 Receiving Notification of Documentation Updates | 31 |
| 8 Detailed Description | 8 | 12.5 Community Resources..... | 32 |
| 8.1 Overview | 8 | 12.6 Trademarks | 32 |
| 8.2 Functional Block Diagrams | 8 | 12.7 Electrostatic Discharge Caution..... | 32 |
| 8.3 Feature Description..... | 9 | 12.8 Glossary | 32 |
| 8.4 Device Functional Modes..... | 11 | 13 Mechanical, Packaging, and Orderable Information | 32 |
| 9 Application and Implementation | 13 | | |

4 Revision History

NOTE: Page numbers for previous revisions may differ from page numbers in the current version.

| Changes from Revision C (November 2014) to Revision D | Page |
|--|-------------|
| • Added "Pin to Pin Compatible with TPS62130 and TPS62140" to <i>Features</i> list | 1 |
| • Changed the T_J MAX value From: 125°C To: 150°C in the <i>Absolute Maximum Rating</i> | 5 |
| • Changed the <i>Thermal Information</i> values | 5 |
| • Changed ($T_J = -40^\circ\text{C}$ to 85°C) To: ($T_J = -40^\circ\text{C}$ to 125°C) in the <i>Electrical Characteristics</i> conditions | 6 |
| • Added a test condition for IQ at $T_A = -40^\circ\text{C}$ to $+85^\circ\text{C}$ in the <i>Electrical Characteristics</i> | 6 |
| • Added Table 1 and Table 2 | 10 |
| • Added indicators (C1, C3, and C5) for capacitances to Figure 7 | 13 |
| • Added Switching Frequency graphs for 1.0-V, 1.8-V, and 5.0-V applications (Figure 24 through Figure 31) | 20 |
| • Changed <i>Layout Example</i> | 29 |

| Changes from Revision B (June 2013) to Revision C | Page |
|---|-------------|
| • Added <i>Device and Documentation Support</i> section, <i>Layout</i> and <i>ESD Ratings</i> table. | 1 |

| Changes from Revision A (November 2012) to Revision B | Page |
|--|-------------|
| • Added device TPS62150A to data sheet | 1 |
| • Added text to Tracking Function section for clarification..... | 17 |

| Changes from Original (November 2011) to Revision A | Page |
|---|-------------|
| • Added values to the Initial output voltage accuracy for TA = –10°C to 85°C..... | 6 |
| • Power-Save Mode Operation section following Equation 1 | 11 |
| • Changed the Layout Guidelines section..... | 29 |
| • Changed Layout Example | 29 |

5 Device Comparison Table

| PART NUMBER | OUTPUT VOLTAGE | Power Good Logic Level (EN=Low) |
|-------------|----------------|---------------------------------|
| TPS62150 | adjustable | High Impedance |
| TPS62150A | adjustable | Low |
| TPS62151 | 1.8 V | High Impedance |
| TPS62152 | 3.3 V | High Impedance |
| TPS62153 | 5.0 V | High Impedance |

6 Pin Configuration and Functions

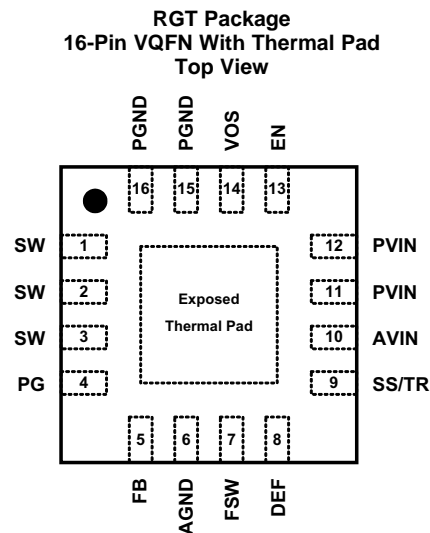

Pin Functions

| PIN ⁽¹⁾ | | I/O | DESCRIPTION |
|--------------------|---------------------|-----|---|
| NO. | NAME | | |
| 1,2,3 | SW | O | Switch node, which is connected to the internal MOSFET switches. Connect inductor between SW and output capacitor. |
| 4 | PG | O | Output power good (High = V_{OUT} ready, Low = V_{OUT} below nominal regulation) ; open drain (requires pull-up resistor) |
| 5 | FB | I | Voltage feedback of adjustable version. Connect resistive voltage divider to this pin. It is recommended to connect FB to AGND on fixed output voltage versions for improved thermal performance. |
| 6 | AGND | | Analog Ground. Must be connected directly to the Exposed Thermal Pad and common ground plane. |
| 7 | FSW | I | Switching Frequency Select (Low \approx 2.5MHz, High \approx 1.25MHz ⁽²⁾ for typical operation) ⁽³⁾ |
| 8 | DEF | I | Output Voltage Scaling (Low = nominal, High = nominal + 5%) ⁽³⁾ |
| 9 | SS/TR | I | Soft-Start / Tracking Pin. An external capacitor connected to this pin sets the internal voltage reference rise time. It can be used for tracking and sequencing. |
| 10 | AVIN | I | Supply voltage for control circuitry. Connect to same source as PVIN. |
| 11,12 | PVIN | I | Supply voltage for power stage. Connect to same source as AVIN. |
| 13 | EN | I | Enable input (High = enabled, Low = disabled) ⁽³⁾ |
| 14 | VOS | I | Output voltage sense pin and connection for the control loop circuitry. |
| 15,16 | PGND | | Power Ground. Must be connected directly to the Exposed Thermal Pad and common ground plane. |
| | Exposed Thermal Pad | | Must be connected to AGND (pin 6), PGND (pin 15,16) and common ground plane. See the Layout Example . Must be soldered to achieve appropriate power dissipation and mechanical reliability. |

- (1) For more information about connecting pins, see the [Detailed Description](#) and [Application and Implementation](#) sections.
(2) Connect FSW to V_{OUT} or PG in this case.
(3) An internal pull-down resistor keeps logic level low, if pin is floating.

7 Specifications

7.1 Absolute Maximum Ratings⁽¹⁾

over operating junction temperature range (unless otherwise noted)

| | | MIN | MAX | UNIT |
|----------------------------|---------------------------------------|------|----------------|------|
| Pin voltage ⁽²⁾ | AVIN, PVIN | -0.3 | 20 | V |
| | EN, SS/TR | -0.3 | $V_{IN} + 0.3$ | |
| | SW | -0.3 | $V_{IN} + 0.3$ | |
| | DEF, FSW, FB, PG, VOS | -0.3 | 7 | |
| Power-good sink current | PG | | 10 | mA |
| Temperature | Operating junction temperature, T_J | -40 | 150 | °C |
| | Storage temperature, T_{stg} | -65 | 150 | °C |

- (1) Stresses beyond those listed under *Absolute Maximum Ratings* may cause permanent damage to the device. These are stress ratings only, and functional operation of the device at these or any other conditions beyond those indicated under *Recommended Operating Conditions* is not implied. Exposure to absolute-maximum-rated conditions for extended periods may affect device reliability.
- (2) All voltages are with respect to network ground terminal.

7.2 ESD Ratings

| | | VALUE | UNIT |
|-------------------------------------|--|-------|------|
| $V_{(ESD)}$ Electrostatic discharge | Human body model (HBM), per ANSI/ESDA/JEDEC JS-001, all pins ⁽¹⁾ | ±2000 | V |
| | Charged device model (CDM), per JEDEC specification JESD22-C101, all pins ⁽²⁾ | ±500 | V |

- (1) JEDEC document JEP155 states that 500-V HBM allows safe manufacturing with a standard ESD control process.
- (2) JEDEC document JEP157 states that 250-V CDM allows safe manufacturing with a standard ESD control process.

7.3 Recommended Operating Conditions

over operating junction temperature range (unless otherwise noted)

| | MIN | NOM | MAX | UNIT |
|---|-----|-----|-----|------|
| Supply Voltage, V_{IN} (at AVIN and PVIN) | | 3 | 17 | V |
| Operating junction temperature, T_J | -40 | | 125 | °C |

7.4 Thermal Information

| THERMAL METRIC ⁽¹⁾ | | TPS6215x | UNIT |
|-------------------------------|--|-------------|------|
| | | RGT 16 PINS | |
| $R_{\theta JA}$ | Junction-to-ambient thermal resistance | 45 | °C/W |
| $R_{\theta JC(top)}$ | Junction-to-case(top) thermal resistance | 53.6 | °C/W |
| $R_{\theta JB}$ | Junction-to-board thermal resistance | 17.4 | °C/W |
| Ψ_{JT} | Junction-to-top characterization parameter | 1.1 | °C/W |
| Ψ_{JB} | Junction-to-board characterization parameter | 17.4 | °C/W |
| $R_{\theta JC(bot)}$ | Junction-to-case(bottom) thermal resistance | 4.5 | °C/W |

- (1) For more information about traditional and new thermal metrics, see the [Semiconductor and IC Package Thermal Metrics](#) application report.

7.5 Electrical Characteristics

 over operating junction temperature ($T_J = -40^{\circ}\text{C}$ to 125°C), typical values at $V_{IN}=12\text{ V}$ and $T_A=25^{\circ}\text{C}$ (unless otherwise noted)

| PARAMETER | | TEST CONDITIONS | MIN | NOM | MAX | UNIT | |
|--|--|---|-----|-----------------|------|--------------------|-----|
| SUPPLY | | | | | | | |
| V_{IN} | Input Voltage Range ⁽¹⁾ | | 3 | | 17 | V | |
| I_Q | Operating Quiescent Current | EN = High, $I_{OUT} = 0\text{ mA}$, device not switching | | 17 | 30 | μA | |
| | | $T_A = -40^{\circ}\text{C}$ to $+85^{\circ}\text{C}$ | | 17 | 25 | | |
| I_{SD} | Shutdown Current ⁽²⁾ | EN = Low | | 1.5 | 25 | μA | |
| | | $T_A = -40^{\circ}\text{C}$ to $+85^{\circ}\text{C}$ | | 1.5 | 4 | | |
| V_{UVLO} | Undervoltage Lockout Threshold | Falling Input Voltage (PWM mode operation) | 2.6 | 2.7 | 2.8 | V | |
| | | Hysteresis | | 200 | | mV | |
| T_{SD} | Thermal Shutdown Temperature | | | 160 | | $^{\circ}\text{C}$ | |
| | Thermal Shutdown Hysteresis | | | 20 | | | |
| CONTROL (EN, DEF, FSW, SS/TR, PG) | | | | | | | |
| V_H | High Level Input Threshold Voltage (EN, DEF, FSW) | | 0.9 | 0.65 | | V | |
| V_L | Low Level Input Threshold Voltage (EN, DEF, FSW) | | | 0.45 | 0.3 | V | |
| I_{LKG} | Input Leakage Current (EN, DEF, FSW) | EN = V_{IN} or GND; DEF, FSW = V_{OUT} or GND | | 0.01 | 1 | μA | |
| V_{TH_PG} | Power Good Threshold Voltage | Rising ($\%V_{OUT}$) | 92% | 95% | 98% | | |
| | | Falling ($\%V_{OUT}$) | 87% | 90% | 94% | | |
| V_{OL_PG} | Power Good Output Low Voltage | $I_{PG} = -2\text{ mA}$ | | 0.07 | 0.3 | V | |
| I_{LKG_PG} | Input Leakage Current (PG) | $V_{PG} = 1.8\text{ V}$ | | 1 | 400 | nA | |
| $I_{SS/TR}$ | SS/TR Pin Source Current | | 2.3 | 2.5 | 2.7 | μA | |
| POWER SWITCH | | | | | | | |
| $r_{DS(on)}$ | High-Side MOSFET ON-Resistance | $V_{IN} \geq 6\text{ V}$ | | 90 | 170 | $\text{m}\Omega$ | |
| | | $V_{IN} = 3\text{ V}$ | | 120 | | | |
| | Low-Side MOSFET ON-Resistance | $V_{IN} \geq 6\text{ V}$ | | 40 | 70 | $\text{m}\Omega$ | |
| | | $V_{IN} = 3\text{ V}$ | | 50 | | | |
| I_{LIMF} | High-Side MOSFET Forward Current Limit ⁽³⁾ | $V_{IN} = 12\text{ V}$, $T_A = 25^{\circ}\text{C}$ | 1.4 | 1.7 | 2.2 | A | |
| OUTPUT | | | | | | | |
| I_{LKG_FB} | Input Leakage Current (FB) | TPS62150, $V_{FB} = 0.8\text{ V}$ | | 1 | 100 | nA | |
| V_{OUT} | Output Voltage Range (TPS62150) | $V_{IN} \geq V_{OUT}$ | 0.9 | | 6.0 | V | |
| | DEF (Output Voltage Programming) | DEF = 0 (GND) | | V_{OUT} | | | |
| | | DEF = 1 (V_{OUT}) | | $V_{OUT} + 5\%$ | | | |
| | Initial Output Voltage Accuracy ⁽⁴⁾ | PWM mode operation, $V_{IN} \geq V_{OUT} + 1\text{ V}$ | | 785.6 | 800 | 814.4 | mV |
| | | PWM mode operation, $V_{IN} \geq V_{OUT} + 1\text{ V}$, $T_A = -10^{\circ}\text{C}$ to 85°C | | 788.0 | 800 | 812.8 | |
| | | Power Save Mode operation, $C_{OUT} = 22\text{ }\mu\text{F}$ | | 781.6 | 800 | 822.4 | |
| | Load Regulation ⁽⁵⁾ | $V_{IN} = 12\text{ V}$, $V_{OUT} = 3.3\text{ V}$, PWM mode operation | | | 0.05 | | %/A |
| Line Regulation ⁽⁵⁾ | $3\text{ V} \leq V_{IN} \leq 17\text{ V}$, $V_{OUT} = 3.3\text{ V}$, $I_{OUT} = 1\text{ A}$, PWM mode operation | | | 0.02 | | %/V | |

- (1) The device is still functional down to Undervoltage Lockout (see parameter V_{UVLO}).
- (2) Current into AVIN+PVIN pins.
- (3) This is the static current limit. It can be temporarily higher in applications due to internal propagation delay (see [Current-Limit and Short-Circuit Protection](#) section).
- (4) This is the accuracy provided at the FB pin for the adjustable V_{OUT} version (line and load regulation effects are not included). For the fixed voltage versions the (internal) resistive divider is included.
- (5) Line and load regulation depend on external component selection and layout (see [Figure 22](#) and [Figure 23](#)).

7.6 Typical Characteristics

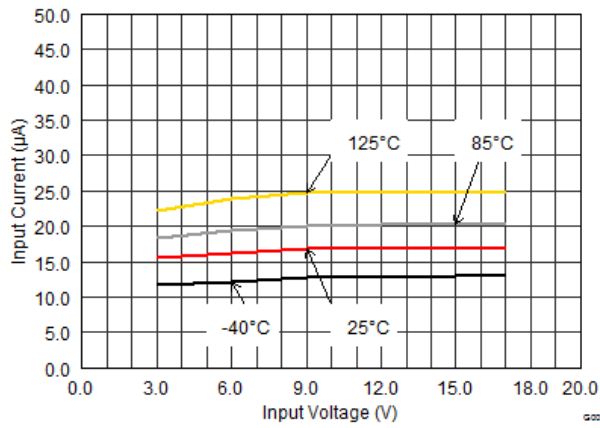

Figure 1. Quiescent Current

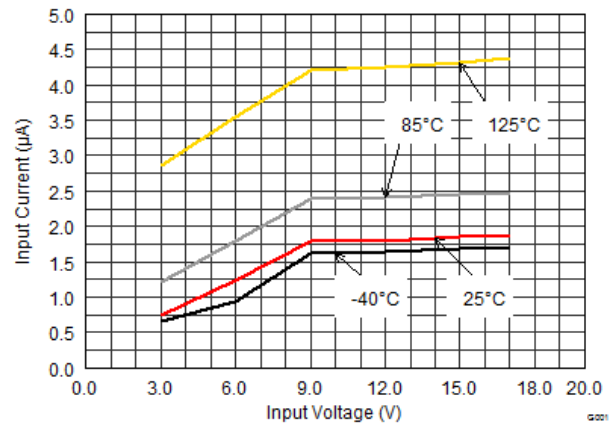

Figure 2. Shutdown Current

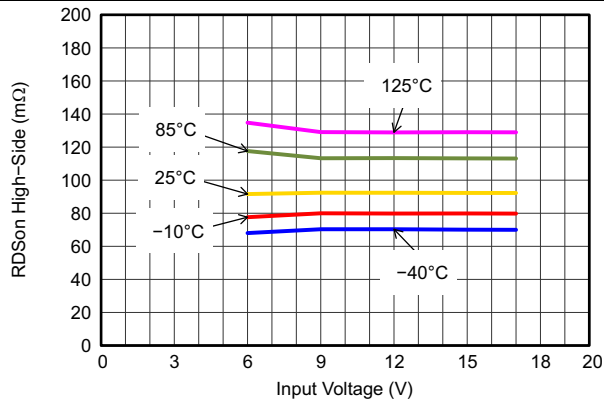

Figure 3. High-Side Switch Resistance

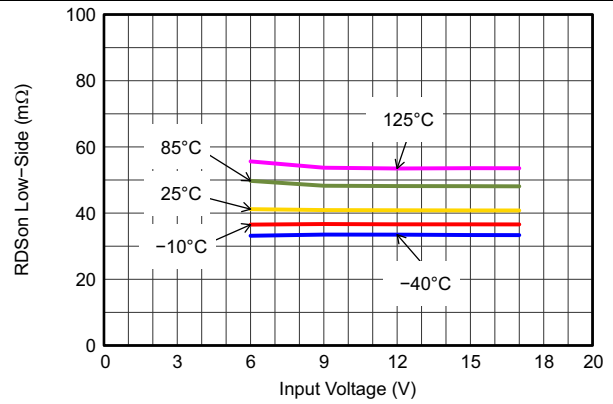

Figure 4. Low-Side Switch Resistance

8 Detailed Description

8.1 Overview

The TPS6215x synchronous switched-mode power converter is based on DCS-Control topology, an advanced regulation topology that combines the advantages of hysteretic, voltage-mode, and current-mode control, including an ac loop directly associated with the output voltage. This control loop takes information about output voltage changes and feeds that information directly to a fast comparator stage. It sets the switching frequency, which is constant for steady-state operating conditions, and provides immediate response to dynamic load changes. To get accurate dc load regulation, a voltage feedback loop is used. The internally compensated regulation network achieves fast and stable operation with small external components and low-ESR capacitors.

The DCS-Control topology supports pulse-width modulation (PWM) mode for medium and heavy load conditions and a power-save mode at light loads. During PWM, it operates at its nominal switching frequency in continuous-conduction mode. This frequency is typically about 2.5 MHz or 1.25 MHz, with a controlled frequency variation depending on the input voltage. If the load current decreases, the converter enters power-save mode to sustain high efficiency down to very light loads. In power-save mode, the switching frequency decreases linearly with the load current. Because DCS-Control topology supports both operation modes within a single building block, the transition from PWM to power-save mode is seamless without effects on the output voltage.

Fixed-output voltage versions provide the smallest solution size and lowest current consumption, requiring only three external components. An internal current limit supports nominal output currents of up to 1 A.

The TPS6215x offers both excellent dc voltage and superior load transient regulation, combined with very low output voltage ripple, minimizing interference with RF circuits.

8.2 Functional Block Diagrams

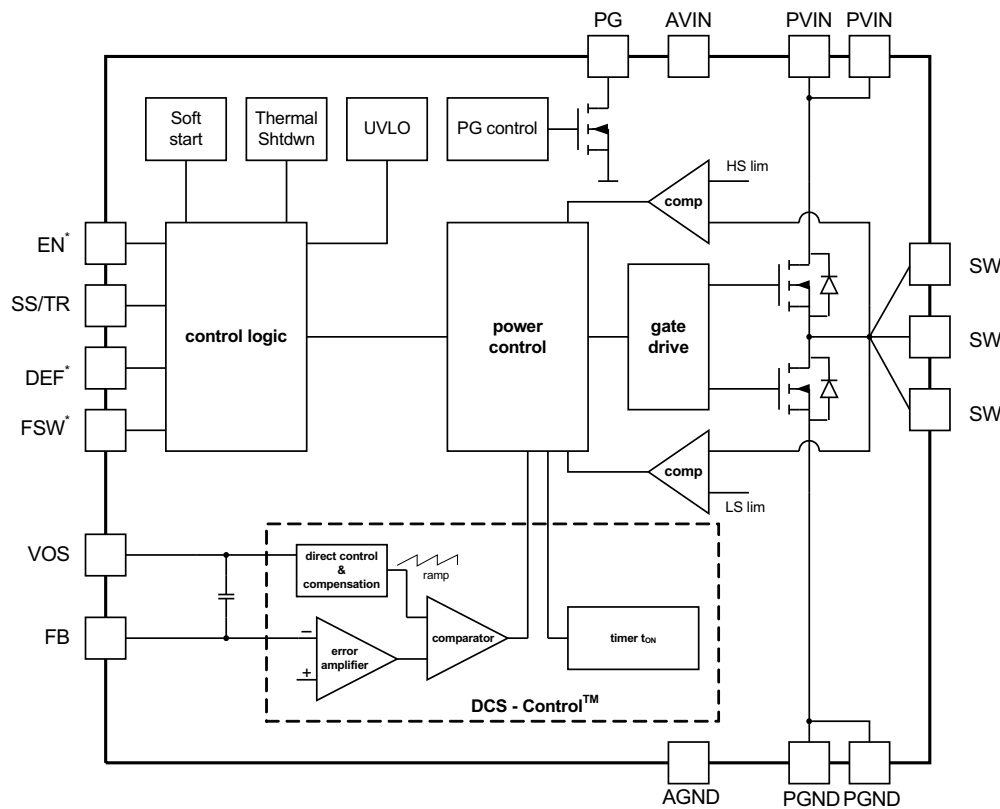

Copyright © 2016, Texas Instruments Incorporated

* This pin is connected to a pull down resistor internally (see [Feature Description](#) section)

Figure 5. TPS62150 (Adjustable Output Voltage)

Functional Block Diagrams (continued)

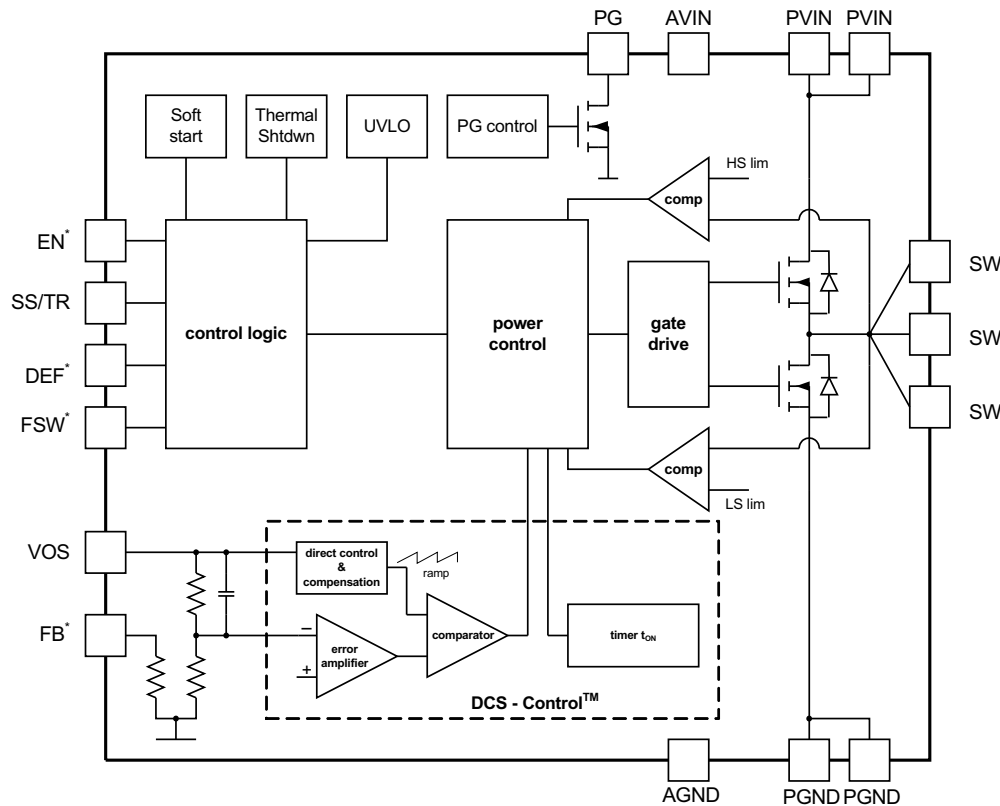

Copyright © 2016, Texas Instruments Incorporated

* This pin is connected to a pull down resistor internally (see [Feature Description](#) section)

Figure 6. TPS62151, -2, -3 (Fixed Output Voltage)

8.3 Feature Description

8.3.1 Enable / Shutdown (EN)

When Enable (EN) is set High, the device starts operation. Shutdown is forced if EN is pulled Low with a shutdown current of typically 1.5µA. During shutdown, the internal power MOSFETs as well as the entire control circuitry are turned off. The internal resistive divider pulls down the output voltage smoothly. The EN signal must be set externally to High or Low. An internal pull-down resistor of about 400kΩ is connected and keeps EN logic low, if Low is set initially and then the pin gets floating. It is disconnected if the pin is set High

Connecting the EN pin to an appropriate output signal of another power rail provides sequencing of multiple power rails.

8.3.2 Soft-Start or Tracking (SS/TR)

The internal soft-start circuitry controls the output voltage slope during start-up. This avoids excessive inrush current and ensures a controlled output-voltage rise time. It also prevents unwanted voltage drops from high-impedance power sources or batteries. When EN is set to start device operation, the device starts switching after a delay of about 50 µs, and V_{OUT} rises with a slope controlled by an external capacitor connected to the SS/TR pin. See [Figure 40](#) and [Figure 41](#) for typical start-up operation.

Feature Description (continued)

Using a very small capacitor (or leaving the SS/TR pin disconnected) provides fastest start-up behavior. There is no theoretical limit for the longest startup time. The TPS6215x can start into a pre-biased output. During monotonic pre-biased start-up, both the power MOSFETs are not allowed to turn on until the internal ramp of the device sets an output voltage above the pre-bias voltage. If the device is set to shutdown (EN = GND), undervoltage lockout, or thermal shutdown, an internal resistor pulls the SS/TR pin down to ensure a proper low level. Returning from those states causes a new start-up sequence as set by the SS/TR connection.

A voltage supplied to SS/TR can be used for tracking a master voltage. The output voltage follows this voltage in both directions, up and down (see [Application and Implementation](#)).

8.3.3 Power Good (PG)

The TPS6215x has a built-in power-good (PG) function to indicate whether the output voltage has reached its appropriate level or not. One use of the PG signal can be for start-up sequencing of multiple rails. The PG pin is an open-drain output that requires a pullup resistor (to any voltage below 7 V). It can sink 2 mA of current and maintain its specified logic-low level. With TPS62150 it is high impedance when the device is turned off due to EN, UVLO or thermal shutdown. TPS62150A features PG=Low in this case and can be used to actively discharge V_{OUT} (see [Figure 45](#)). V_{IN} must remain present for the PG pin to stay Low. See [SLVA644](#) for application details. If not used, the PG pin should be connected to GND but may be left floating.

Table 1. Power Good Pin Logic Table (TPS62150)

| Device State | | PG Logic Status | |
|----------------------|------------------------------------|-----------------|-----|
| | | High Impedance | Low |
| Enable (EN=High) | $V_{FB} \geq V_{TH_PG}$ | √ | |
| | $V_{FB} \leq V_{TH_PG}$ | | √ |
| Shutdown (EN=Low) | | √ | |
| UVLO | $0.7\text{ V} < V_{IN} < V_{UVLO}$ | √ | |
| Thermal Shutdown | $T_J > T_{SD}$ | √ | |
| Power Supply Removal | $V_{IN} < 0.7\text{ V}$ | √ | |

Table 2. Power Good Pin Logic Table (TPS62150A)

| Device State | | PG Logic Status | |
|----------------------|------------------------------------|-----------------|-----|
| | | High Impedance | Low |
| Enable (EN=High) | $V_{FB} \geq V_{TH_PG}$ | √ | |
| | $V_{FB} \leq V_{TH_PG}$ | | √ |
| Shutdown (EN=Low) | | | √ |
| UVLO | $0.7\text{ V} < V_{IN} < V_{UVLO}$ | | √ |
| Thermal Shutdown | $T_J > T_{SD}$ | | √ |
| Power Supply Removal | $V_{IN} < 0.7\text{ V}$ | √ | |

8.3.4 Pin-Selectable Output Voltage (DEF)

Setting the DEF pin to High increases the output voltage of the TPS62150x devices by 5% above the nominal voltage ⁽¹⁾. When DEF is Low, the device regulates to the nominal output voltage. Increasing the nominal voltage allows adapting the power supply voltage to the variations of the application hardware. More detailed information on voltage margining using the TPS62150x device is in [SLVA489](#). The pin has an internally connected pulldown resistor of about 400 kΩ to ensure a proper logic level if the pin is high-impedance or floating after an initially Low setting. Setting the pin High disconnects the resistor.

(1) Maximum allowed voltage is 7 V. Therefore, the recommended connection for DEF is to V_{OUT} , not V_{IN} .

8.3.5 Frequency Selection (FSW)

To get high power density with a very small solution size, a high switching frequency allows the use of small external components for the output filter. However, switching losses increase with the switching frequency. If efficiency is the key parameter, more than solution size, the switching frequency can be set to half (1.25 MHz typical) by pulling FSW to High. It is mandatory to start with FSW = Low to limit inrush current, which connecting FSW to V_{OUT} or PG can accomplish. Running with lower frequency produces higher efficiency, but also creates higher output-voltage ripple. Pull FSW to Low for high-frequency operation (2.5 MHz typical). To get low ripple and full output current at the lower switching frequency, the recommended minimum inductor value is 2.2 μH . An application can change the switching frequency during operation, if needed. An internally connected pulldown resistor of about 400 k Ω on this pin acts the same way as one on the DEF pin (see [Pin-Selectable Output Voltage \(DEF\)](#)).

8.3.6 Undervoltage Lockout (UVLO)

If the input voltage drops, the undervoltage lockout prevents faulty operation of the device by switching off both the power FETs. The typical undervoltage-lockout threshold setting is 2.7 V. The device is fully operational for voltages above the UVLO threshold and turns off if the input voltage trips the threshold. The converter starts operation again once the input voltage exceeds the threshold by a hysteresis of typically 200 mV.

8.3.7 Thermal Shutdown

An internal temperature sensor monitors the junction temperature (T_J) of the device. If T_J exceeds 160°C (typ), the device goes into thermal shutdown. Both the high-side and low-side power FETs turn off and PG goes into the high-impedance state. When T_J decreases below the hysteresis level, the converter resumes normal operation, beginning with soft start. To avoid unstable conditions, the device implements a hysteresis of typically 20°C on the thermal shutdown temperature.

8.4 Device Functional Modes

8.4.1 Pulse-Width Modulation (PWM) Operation

The TPS6215x operates using pulse-width modulation in continuous-conduction mode (CCM) with a nominal switching frequency of 2.5 MHz or 1.25 MHz, selectable with the FSW pin. The frequency variation in the PWM mode is controlled and depends on V_{IN} , V_{OUT} , and the inductance. The device operates in PWM mode as long the output current is higher than half the inductor ripple current. To maintain high efficiency at light loads, the device enters power-save mode at the boundary of discontinuous conduction mode (DCM). This happens if the output current becomes smaller than half the inductor ripple current.

8.4.2 Power-Save Mode Operation

The TPS6215x enters its built-in power-save mode seamlessly if the load current decreases. This secures a high efficiency in light load operation. The device remains in power-save mode as long as the inductor current is discontinuous.

In power-save mode, the switching frequency decreases linearly with the load current, maintaining high efficiency. The transition into and out of power-save mode happens within the entire regulation scheme and is seamless in both directions.

TPS6215x includes a fixed on-time circuitry. An estimate for this on-time, in steady-state operation with FSW=Low, is:

$$t_{ON} = \frac{V_{OUT}}{V_{IN}} \times 400 \text{ ns} \quad (1)$$

For very small output voltages, an absolute minimum on-time of about 80 ns is kept to limit switching losses. The operating frequency is thereby reduced from its nominal value, which keeps efficiency high. Also, the off-time can reach its minimum value at high duty cycles. The output voltage remains regulated in such cases. Using t_{ON} , the typical peak inductor current in power-save mode is approximated by:

Device Functional Modes (continued)

$$I_{LPSM(peak)} = \frac{(V_{IN} - V_{OUT})}{L} \times t_{ON} \quad (2)$$

When V_{IN} decreases to typically 15% above V_{OUT} , the TPS62150x device does not enter power-save mode, regardless of the load current. The device maintains output regulation in PWM mode.

8.4.3 100% Duty-Cycle Operation

The duty cycle of the buck converter is given by $D = V_{OUT} / V_{IN}$ and increases as the input voltage comes close to the output voltage. In this case, the device starts 100% duty cycle operation turning on the high-side switch 100% of the time. The high-side switch stays turned on as long as the output voltage is below the internal set point. This allows the conversion of small input-to-output voltage differences, for example, for longest operation time of battery-powered applications. In 100% duty cycle mode, the low-side FET is switched off.

The minimum input voltage to maintain output voltage regulation, depending on the load current and the output voltage level, is calculated as:

$$V_{IN(min)} = V_{OUT(min)} + I_{OUT} \times (R_{DS(on)} + R_L)$$

where

- I_{OUT} is the output current
- $R_{DS(on)}$ is the on-state resistance of the high-side FET
- R_L is the dc resistance of the inductor

(3)

8.4.4 Current-Limit and Short-Circuit Protection

The TPS6215x devices have protection against heavy-load and short-circuit events. At heavy loads, the current limit determines the maximum output current. If the current limit is reached, the high-side FET is turned off. Avoiding shoot-through current, then the low-side FET switches on to allow the inductor current to decrease. The low-side current limit is typically 1.2 A. The high-side FET turns on again only if the current in the low-side FET has decreased below the low-side current-limit threshold.

The output current of the device is limited by the current limit (see [Electrical Characteristics](#)). Due to internal propagation delay, the actual current can exceed the static current limit during that time. The dynamic current limit is calculated as follows:

$$I_{peak(typ)} = I_{LIMF} + \frac{V_L}{L} \times t_{PD}$$

where

- I_{LIMF} is the static current limit, specified in the [Electrical Characteristics](#)
- V_L is the voltage across the inductor ($V_{IN} - V_{OUT}$)
- L is the inductor value
- t_{PD} is the internal propagation delay

(4)

The current limit can exceed static values, especially if the input voltage is high and the application uses very small inductances. Calculate the peak current in the dynamic high-side switch using the following equation:

$$I_{peak(typ)} = I_{LIMF} + \frac{(V_{IN} - V_{OUT})}{L} \times 30 \text{ ns} \quad (5)$$

9 Application and Implementation

NOTE

Information in the following applications sections is not part of the TI component specification, and TI does not warrant its accuracy or completeness. TI's customers are responsible for determining suitability of components for their purposes. Customers should validate and test their design implementation to confirm system functionality.

9.1 Application Information

The TPS6215x devices are a switched-mode step-down converters, able to convert a 3-V to 17-V input voltage into a 0.9-V to 6-V output voltage, providing up to 1 A. They require a minimum number of external components. Apart from the LC output filter and the input capacitors, only the TPS62150 device needs an additional resistive divider to set the output voltage level.

9.2 Typical Application

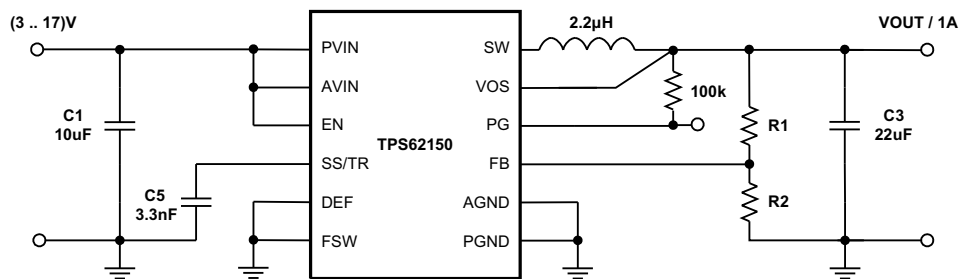

Copyright © 2016, Texas Instruments Incorporated

Figure 7. A Typical 1-A Step-Down Converter

9.2.1 Design Requirements

The following design guideline provides a component selection to operate the device within the recommended operating conditions. Using the FSW pin, the design can be optimized for highest efficiency or smallest solution size and lowest output-voltage ripple. For highest efficiency set FSW = High, and the device operates at the lower switching frequency. For smallest solution size and lowest output voltage ripple set FSW = Low, and the device operates with higher switching frequency. The typical values for all measurements are $V_{IN} = 12\text{ V}$, $V_{OUT} = 3.3\text{ V}$, and $T = 25^\circ\text{C}$, using the external components of [Table 3](#).

The component selection used for measurements is given as follows:

Table 3. List of Components

| REFERENCE | DESCRIPTION | MANUFACTURER ⁽¹⁾ |
|-----------|--|--------------------------------|
| IC | 17-V, 1-A step-down converter, QFN | TPS62150RGT, Texas Instruments |
| L1 | 2.2-µH, 3.1-A, 0.165-in × 0.165-in (4.19-mm × 4.19-mm) | XFL4020-222MEB, Coilcraft |
| C1 | 10-µF, 25-V, ceramic, 1210 | Standard |
| C3 | 22-µF, 6.3-V, ceramic, 0805 | Standard |
| C5 | 3300-pF, 25-V, ceramic, 0603 | |
| R1 | Depending on V_{OUT} | |
| R2 | Depending on V_{OUT} | |
| R3 | 100-kΩ, chip, 0603, 1/16-W, 1% | Standard |

(1) See [Third-Party Products](#) Disclaimer

9.2.2 Detailed Design Procedure

9.2.2.1 Programming the Output Voltage

Whereas the output voltage of the TPS62150 (TPS62150A) is adjustable, the TPS62151, -2, and -3 are programmed to fixed output voltages. For fixed output versions, the FB pin is pulled down internally and may be left floating. It is recommended to connect the FB pin to AGND to decrease thermal resistance. The adjustable version can be programmed for output voltages from 0.9 V to 6 V by using a resistive divider from V_{OUT} to AGND. The voltage at the FB pin is regulated to 800 mV. The value of the output voltage is set by the selection of the resistive divider from Equation 6. It is recommended to choose resistor values which allow a current of at least 2 μ A, meaning the value of R2 should not exceed 400 k Ω . Lower resistor values are recommended for highest accuracy and most robust design. For applications requiring lowest current consumption, the use of fixed-output-voltage versions is recommended.

$$R_1 = R_2 \times \left(\frac{V_{OUT}}{V_{REF}} - 1 \right) \quad (6)$$

In case of an open on the FB pin, the device clamps the output voltage at the VOS pin internally to about 7.4 V.

9.2.2.2 External Component Selection

The external components must fulfill the needs of the application, but also the stability criteria for the control loop of the device. The TPS6215x device is optimized to work within a range of external components. Consider the inductance and capacitance of the LC output filters in conjunction, creating the double pole responsible for the corner frequency of the converter (see the [Output Filter and Loop Stability](#) section). Table 4 can be used to simplify the output filter component selection. Checked cells represent combinations that are proven for stability by simulation and lab test. Further combinations should be checked for each individual application. See [SLVA463](#) for details.

Table 4. L-C Output Filter Combinations⁽¹⁾

| | 4.7 μ F | 10 μ F | 22 μ F | 47 μ F | 100 μ F | 200 μ F | 400 μ F |
|--------------|-------------|------------|------------------|------------|-------------|-------------|-------------|
| 0.47 μ H | | | | | | | |
| 1 μ H | | | √ | √ | √ | √ | |
| 2.2 μ H | | √ | √ ⁽²⁾ | √ | √ | √ | |
| 3.3 μ H | | √ | √ | √ | √ | | |
| 4.7 μ H | | | | | | | |

(1) The values in the table are nominal values. The effective capacitance was considered to vary by +20% and -50%.

(2) This LC combination is the standard value, and is recommended for most applications.

The TPS6215x device can operate with an inductor as low as 1 μ H or 2.2 μ H. FSW should be set Low in this case. However, for applications running with the low-frequency setting (FSW = High) or with low input voltages, 3.3 μ H is recommended.

9.2.2.2.1 Inductor Selection

The inductor selection is affected by several effects like inductor ripple current, output ripple voltage, PWM-to-PSM transition point, and efficiency. In addition, the inductor selected must be rated for appropriate saturation current and dc resistance (DCR). Equation 7 and Equation 8 calculate the maximum inductor current under static load conditions.

$$I_{L(max)} = I_{OUT(max)} + \frac{\Delta I_{L(max)}}{2} \quad (7)$$

$$\Delta I_{L(\max)} = V_{OUT} \times \left(\frac{1 - \frac{V_{OUT}}{V_{IN(\max)}}}{L_{(\min)} \times f_{SW}} \right)$$

where

- $I_{L(\max)}$ is the maximum inductor current
 - ΔI_L is the peak-to-peak inductor ripple current
 - $L_{(\min)}$ is the minimum effective inductor value
 - f_{SW} is the actual PWM switching frequency
- (8)

Calculating the maximum inductor current using the actual operating conditions gives the minimum required saturation current of the inductor. An added margin of about 20% is recommended. A larger inductor value is also useful to get lower ripple current, but increases the transient response time and size as well. The following inductors have been used with the TPS6215x device and are recommended for use:

Table 5. List of Inductors

| TYPE | INDUCTANCE [μ H] | SATURATION CURRENT [A] ⁽¹⁾ | DIMENSIONS [L x W x H], mm | MANUFACTURER ⁽²⁾ |
|--------------------|------------------------|---------------------------------------|----------------------------|-----------------------------|
| XFL4020-222ME_ | 2.2 μ H, \pm 20% | 3.5 | 4 x 4 x 2.1 | Coilcraft |
| XFL3012-222MEC | 2.2 μ H, \pm 20% | 1.6 | 3 x 3 x 1.2 | Coilcraft |
| XFL3012-332MEC | 3.3 μ H, \pm 20% | 1.4 | 3 x 3 x 1.2 | Coilcraft |
| VLS252012T-2R2M1R3 | 2.2 μ H, \pm 20% | 1.3 | 2.5 x 2 x 1.2 | TDK |
| LPS3015-332 | 3.3 μ H, \pm 20% | 1.4 | 3 x 3 x 1.4 | Coilcraft |
| 744025003 | 3.3 μ H, \pm 20% | 1.5 | 2.8 x 2.8 x 2.8 | Wuerth |
| PSI25201B-2R2MS | 2.2 μ H, \pm 20% | 1.3 | 2 x 2.5 x 1.2 | Cyntec |
| NR3015T-2R2M | 2.2 μ H, \pm 20% | 1.5 | 3 x 3 x 1.5 | Taiyo Yuden |

(1) Lower of I_{RMS} at 40°C rise or I_{SAT} at 30% drop.

(2) See [Third-Party Products](#) Disclaimer

The inductor value also determines the load current at which the device enters power-save mode:

$$I_{load(PSM)} = \frac{1}{2} \Delta I_L$$
(9)

Using [Equation 8](#), this current level can be adjusted by changing the inductor value.

9.2.2.2.2 Capacitor Selection

9.2.2.2.2.1 Output Capacitor

The recommended value for the output capacitor is 22 μ F. The architecture of the TPS6215x device allows the use of tiny ceramic output capacitors with low equivalent series resistance (ESR). These capacitors provide low output-voltage ripple and are recommended. To keep its low resistance up to high frequencies and to get narrow capacitance variation with temperature, it is recommended to use X7R or X5R dielectric. Using a higher value of output capacitance can have some advantages, like smaller voltage ripple and a tighter dc output accuracy in power-save mode (see [SLVA463](#)).

Note: In power-save mode, the output-voltage ripple depends on the output capacitance, the ESR of the output capacitor, and the peak inductor current. Using ceramic capacitors provides small ESR and low ripple.

9.2.2.2.2 Input Capacitor

For most applications, 10 μF is sufficient and is recommended, though a larger value reduces input-current ripple further. The input capacitor buffers the input voltage for transient events and also decouples the converter from the supply. A low-ESR multilayer ceramic capacitor is recommended for best filtering and should be placed between PVIN and PGND as close as possible to those pins. Even though AVIN and PVIN must be supplied from the same input source, it is recommended to place a capacitance of 0.1 μF from AVIN to AGND, to avoid potential noise coupling. An RC, low-pass filter from PVIN to AVIN may be used but is not required.

9.2.2.2.3 Soft-Start Capacitor

A capacitance connected between the SS/TR pin and AGND allows a user-programmable start-up slope of the output voltage. A constant-current source supplies 2.5 μA to charge the external capacitance. The capacitor required for a given soft-start ramp time for the output voltage is given by:

$$C_{\text{SS}} = t_{\text{SS}} \times \frac{2.5 \mu\text{A}}{1.25 \text{V}} \quad [\text{F}]$$

where

- C_{SS} is the capacitance (F) required at the SS/TR pin
 - t_{SS} is the desired soft-start ramp time (s)
- (10)

NOTE

DC bias effect: High capacitance ceramic capacitors have a dc bias effect, which has a strong influence on the final effective capacitance. Therefore, selecting the right capacitor value requires careful choice. Package size and voltage rating in combination with dielectric material are responsible for differences between the rated capacitor value and the effective capacitance.

9.2.2.3 Tracking Function

If a tracking function is desired, the SS/TR pin can be used for this purpose by connecting it to an external tracking voltage. The output voltage tracks that voltage. If the tracking voltage is between 50 mV and 1.2 V, the FB pin will track the SS/TR pin voltage as described in [Equation 11](#) and shown in [Figure 8](#).

$$V_{\text{FB}} \approx 0.64 \times V_{\text{SS/TR}} \quad (11)$$

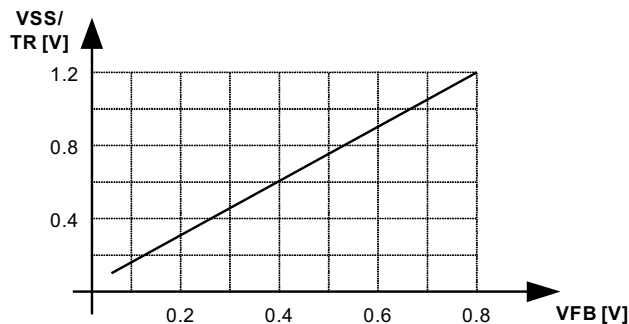
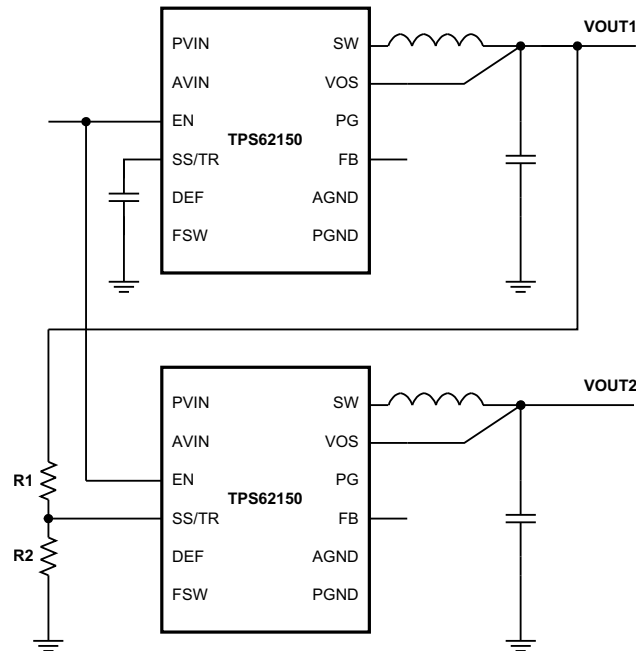

Figure 8. Voltage Tracking Relationship

Once the SS/TR pin voltage reaches about 1.2 V, the internal voltage is clamped to the internal feedback voltage and device goes to normal regulation. This works for rising and falling tracking voltages with the same behavior, as long as the input voltage is inside the recommended operating conditions. For decreasing SS/TR pin voltage, the device does not sink current from the output. So, the resulting decrease of the output voltage may be slower than the SS/TR pin voltage if the load is light. When driving the SS/TR pin with an external voltage, do not exceed the voltage rating of the SS/TR pin, which is $V_{IN} + 0.3$ V.

If the input voltage drops into undervoltage lockout or even down to zero, the output voltage goes to zero, independent of the tracking voltage. Figure 9 shows how to connect devices to get ratiometric and simultaneous sequencing by using the tracking function.



Copyright © 2016, Texas Instruments Incorporated

Figure 9. Schematic for Ratiometric and Simultaneous Start-Up

The resistive divider of R1 and R2 can be used to change the ramp rate of VOUT2 faster, slower, or the same as that of VOUT1.

A sequential start-up is achieved by connecting the PG pin of VOUT1 to the EN pin of VOUT2. A ratiometric start-up sequence happens if both supplies share the same soft-start capacitor. Equation 10 calculates the soft-start time, though the SS/TR current must be doubled. Details about these and other tracking and sequencing circuits are found in the *TPS62130/40/50 Sequencing and Tracking* application report, [SLVA470](#).

Note: If the voltage at the FB pin is below its typical value of 0.8 V, the output voltage accuracy may have a wider tolerance than specified.

9.2.2.4 Output Filter and Loop Stability

The devices of the TPS6215x family are internally compensated to be stable with L-C filter combinations corresponding to a corner frequency to be calculated with [Equation 12](#):

$$f_{LC} = \frac{1}{2\pi\sqrt{L \times C}} \quad (12)$$

Proven nominal values for inductance and ceramic capacitance are given in [Table 4](#) and are recommended for use. Different values may work, but care must be taken on the loop stability, which is affected. More information, including a detailed L-C stability matrix, can be found in the *TPS62130/40/50 Sequencing and Tracking* application report, [SLVA463](#).

The TPS6215x devices, both fixed and adjustable versions, include an internal 25-pF feedforward capacitor, connected between the VOS and FB pins. This capacitor impacts the frequency behavior and sets a pole and zero in the control loop with the resistors of the feedback divider, per equations [Equation 13](#) and [Equation 14](#):

$$f_{zero} = \frac{1}{2\pi \times R_1 \times 25 \text{ pF}} \quad (13)$$

$$f_{pole} = \frac{1}{2\pi \times 25 \text{ pF}} \times \left(\frac{1}{R_1} + \frac{1}{R_2} \right) \quad (14)$$

Though the TPS6215x devices are stable without the pole and zero being in a particular location, adjusting their location to the specific needs of the application can provide better performance in power-save mode and/or improved transient response. An external feedforward capacitor can also be added. A more-detailed discussion on the optimization for stability versus transient response can be found in the *Optimizing Transient Response of Internally Compensated dc-dc Converters With Feedforward Capacitor* and *Using a Feedforward Capacitor to Improve Stability and Bandwidth of TPS62130/40/50/60/70* application reports, [SLVA289](#) and [SLVA466](#), respectively.

9.2.3 Application Curves

$V_{IN} = 12\text{ V}$, $V_{OUT} = 3.3\text{ V}$, $T_A = 25^\circ\text{C}$, (unless otherwise noted)

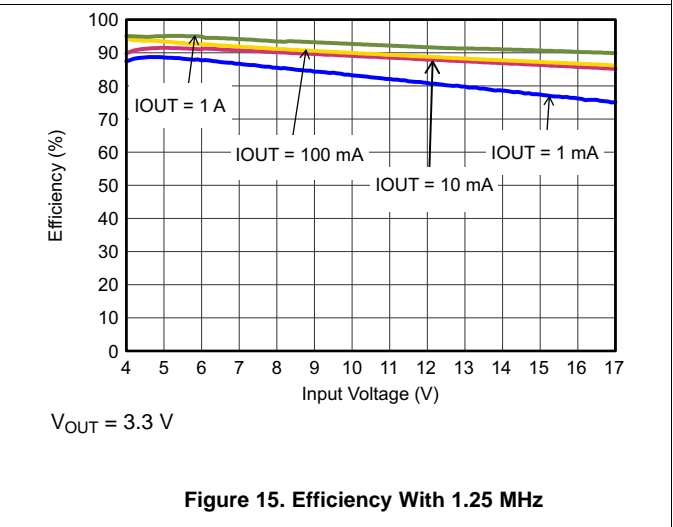
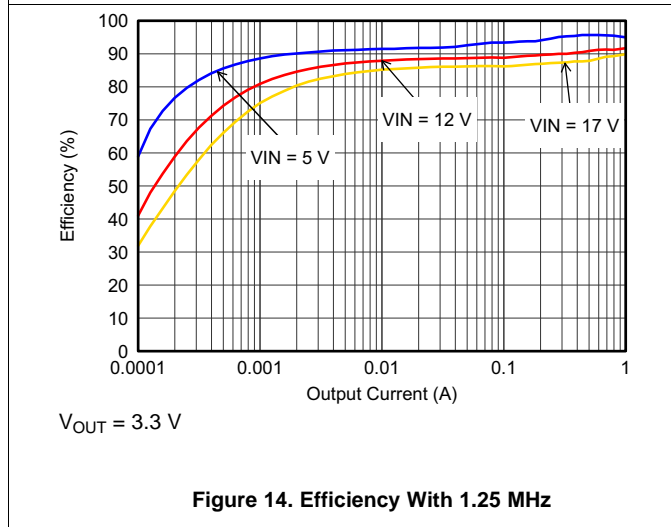
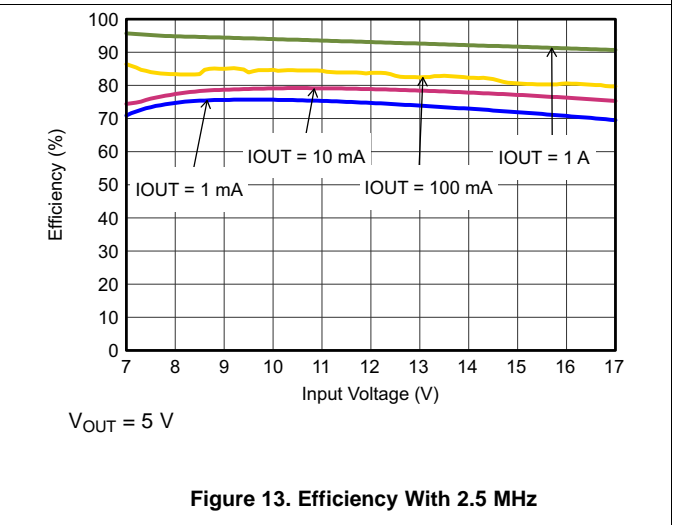
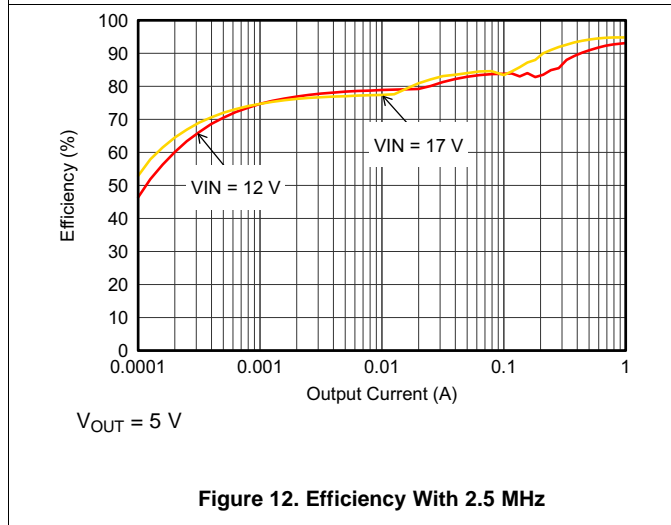
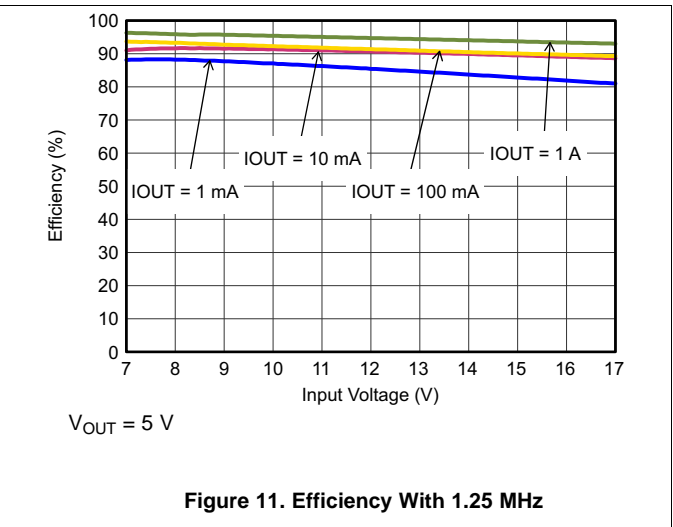
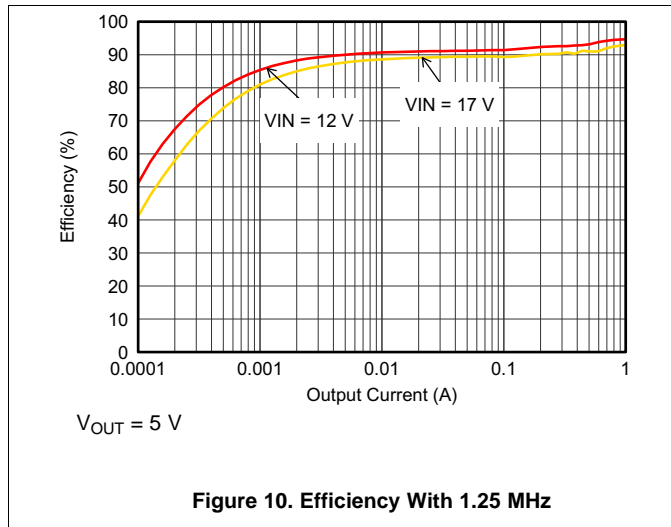

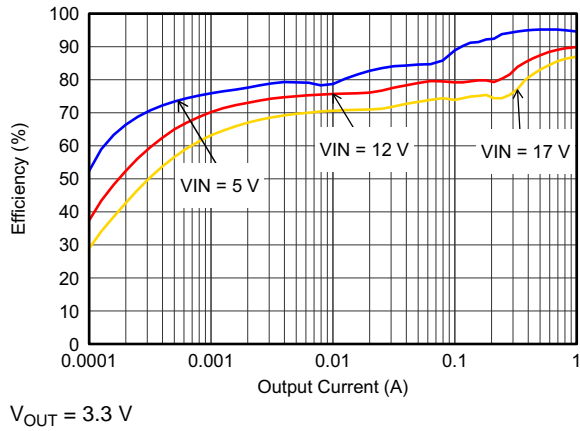

Figure 16. Efficiency With 2.5 MHz

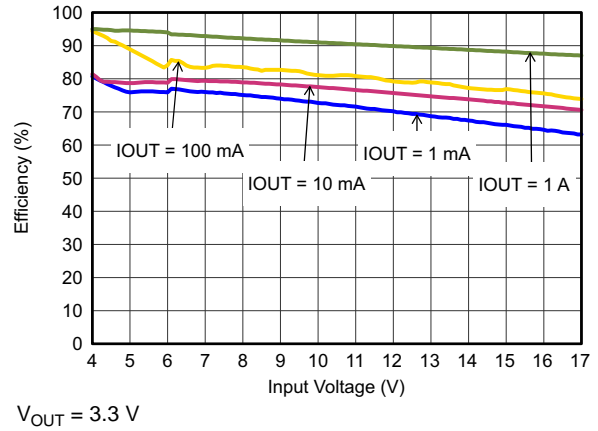

Figure 17. Efficiency With 2.5 MHz

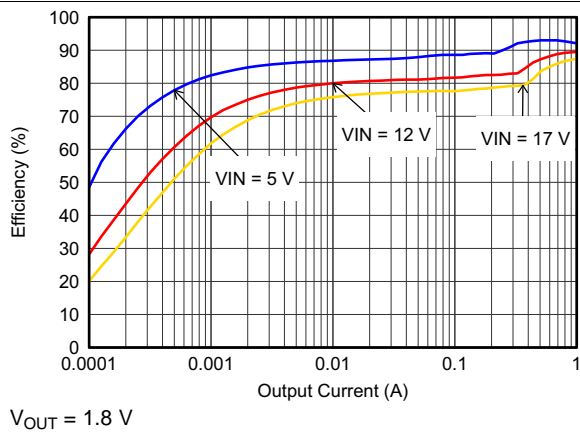

Figure 18. Efficiency With 1.25 MHz

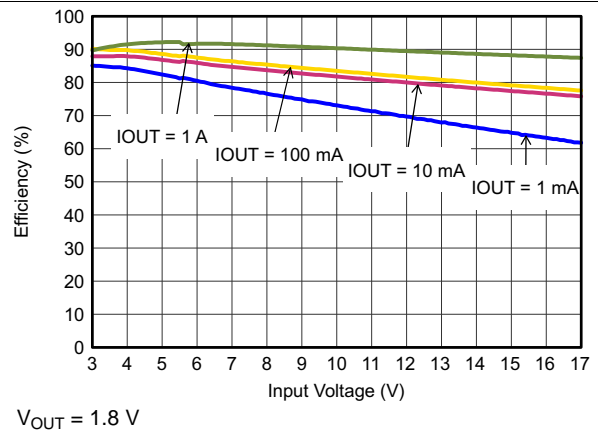

Figure 19. Efficiency With 1.25 MHz

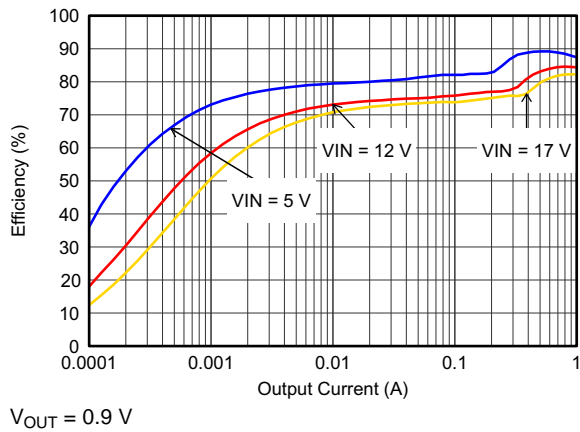

Figure 20. Efficiency With 1.25 MHz

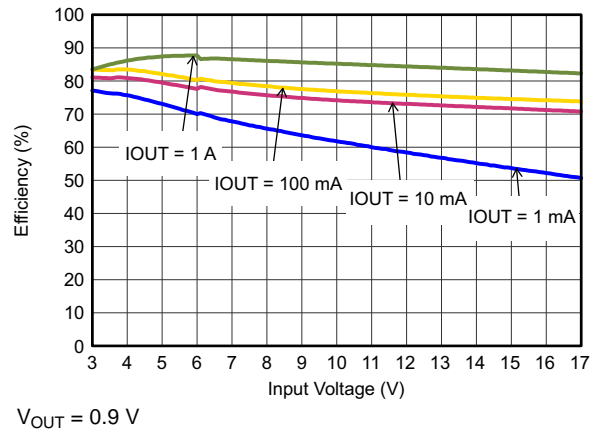

Figure 21. Efficiency With 1.25 MHz

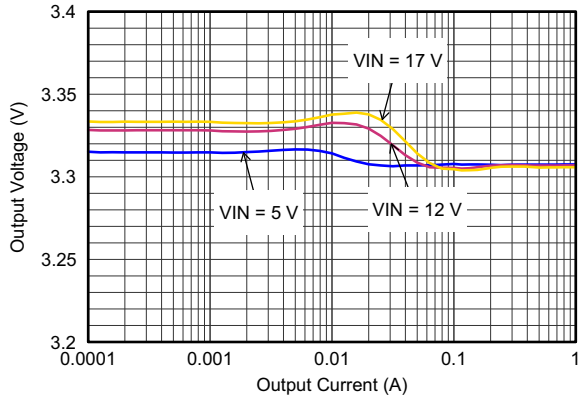

Figure 22. Output Voltage Accuracy (Load Regulation)

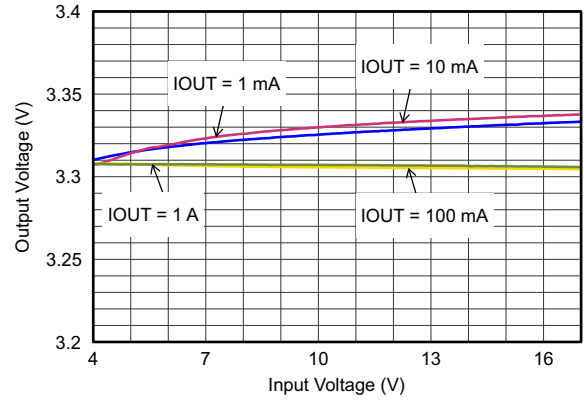

Figure 23. Output Voltage Accuracy (Line Regulation)

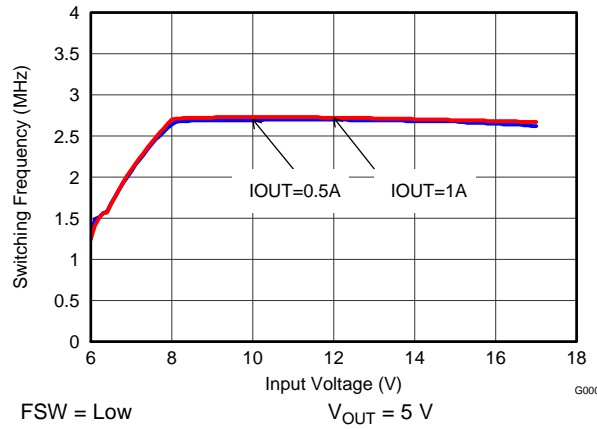

Figure 24. Switching Frequency vs Input Voltage

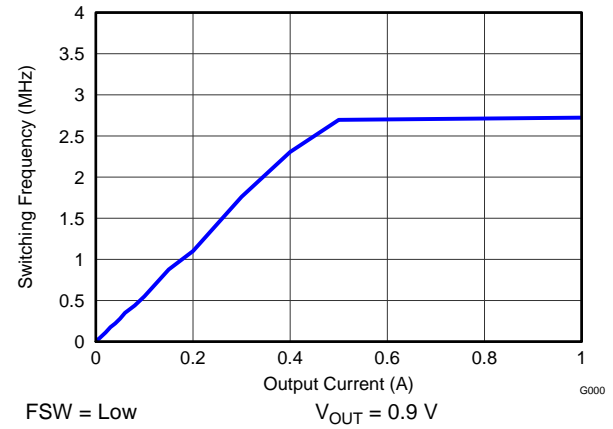

Figure 25. Switching Frequency vs Output Current

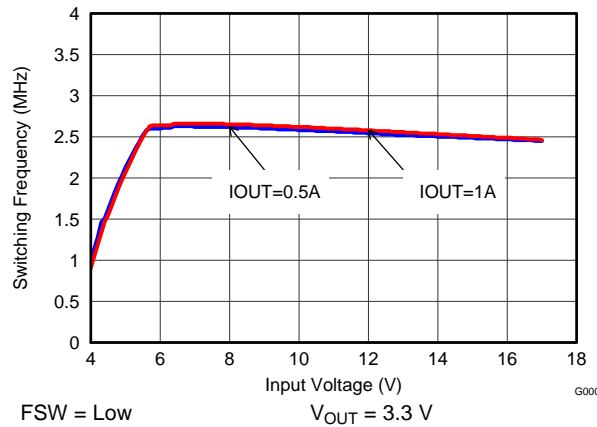

Figure 26. Switching Frequency vs Input Voltage

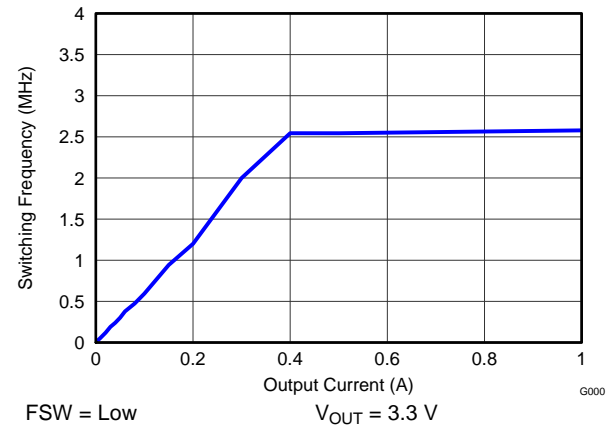

Figure 27. Switching Frequency vs Output Current

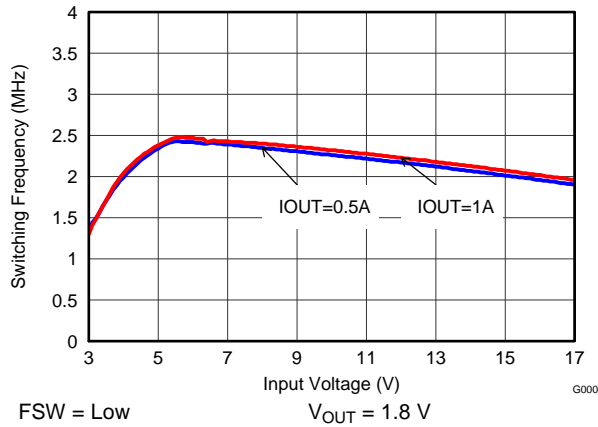

Figure 28. Switching Frequency vs Input Voltage

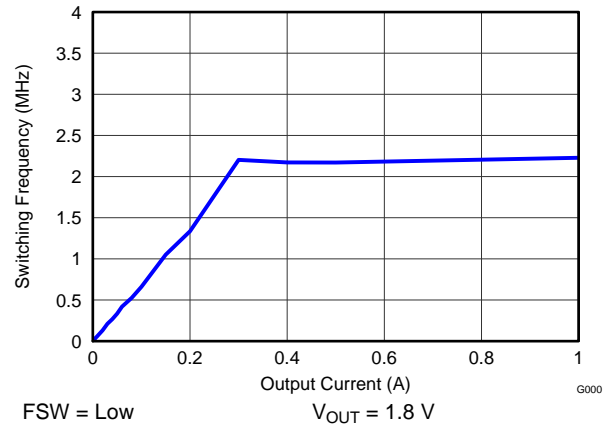

Figure 29. Switching Frequency vs Output Current

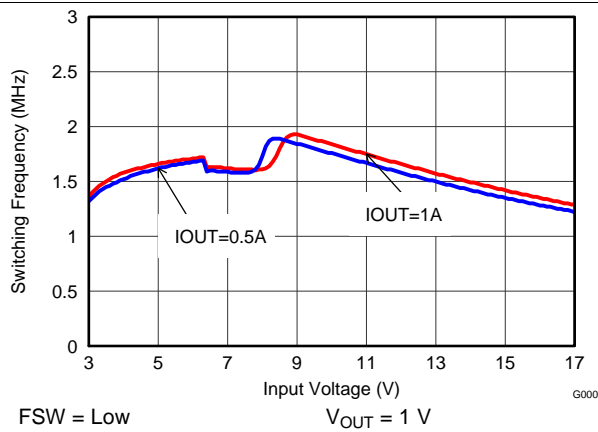

Figure 30. Switching Frequency vs Input Voltage

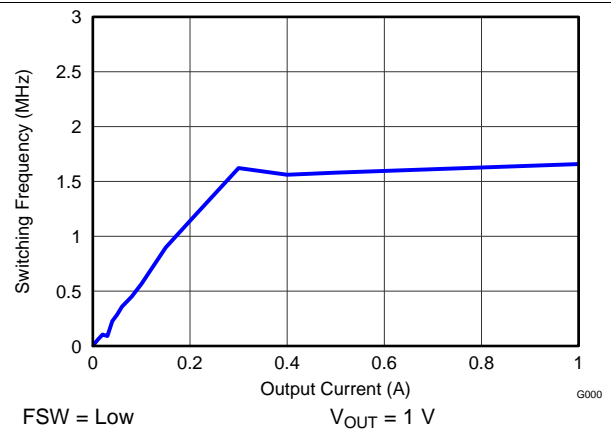

Figure 31. Switching Frequency vs Output Current

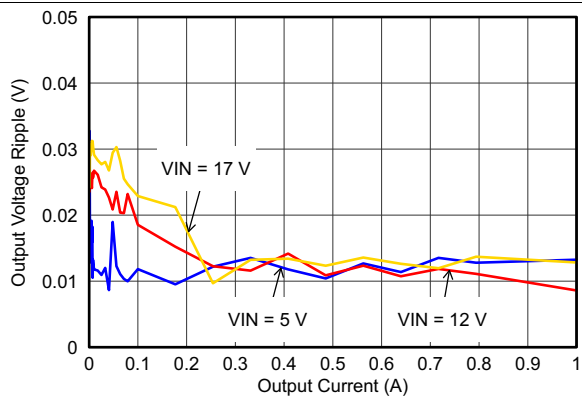

Figure 32. Output Voltage Ripple

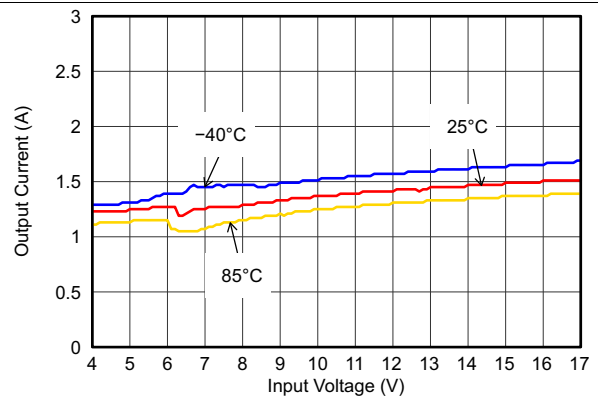

Figure 33. Maximum Output Current

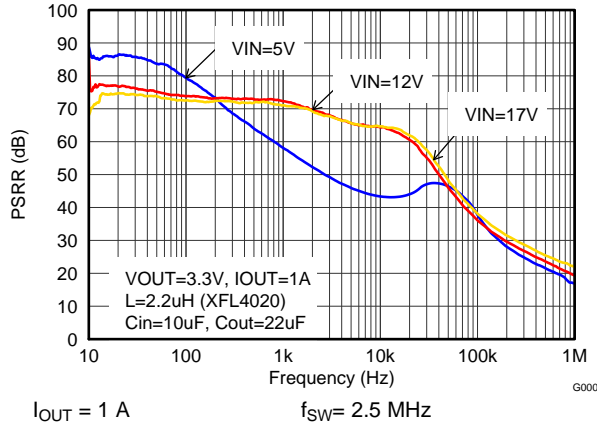

Figure 34. Power-Supply Rejection Ratio

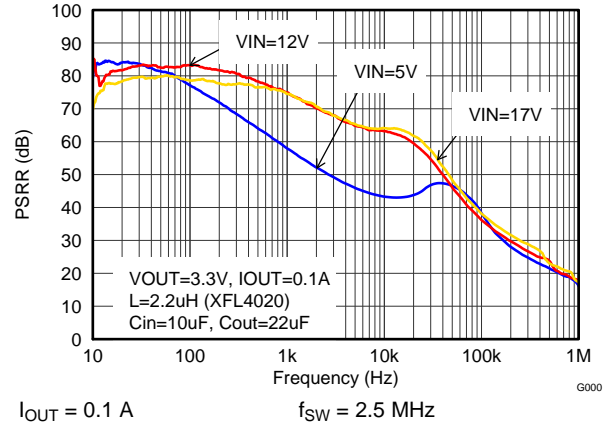

Figure 35. Power-Supply Rejection Ratio

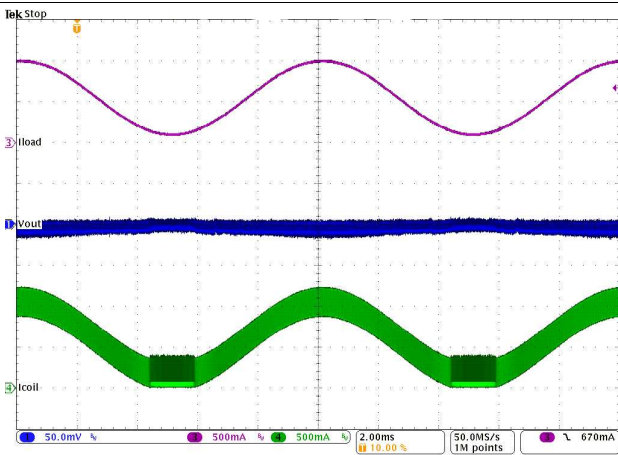

Figure 36. PWM-to-PSM Transition

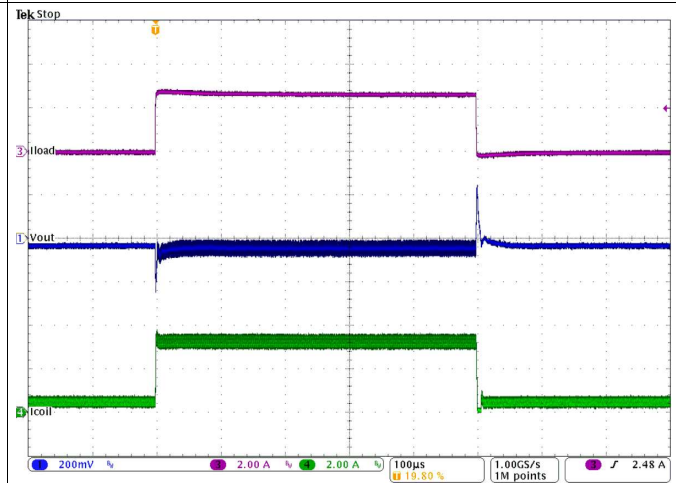

Figure 37. Load Transient Response

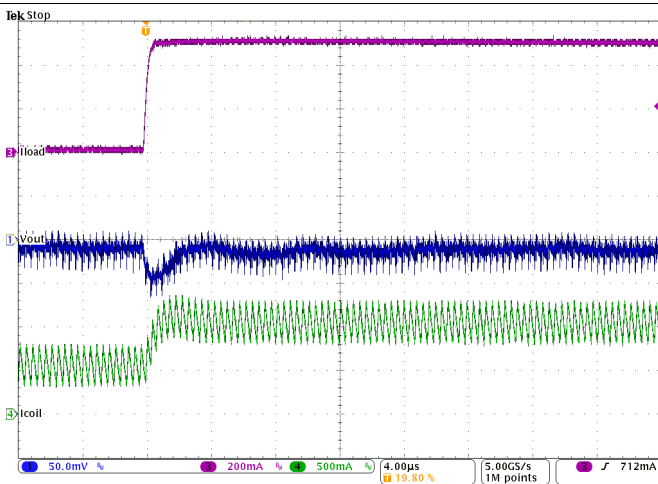

Figure 38. Load Transient Response, Rising Edge

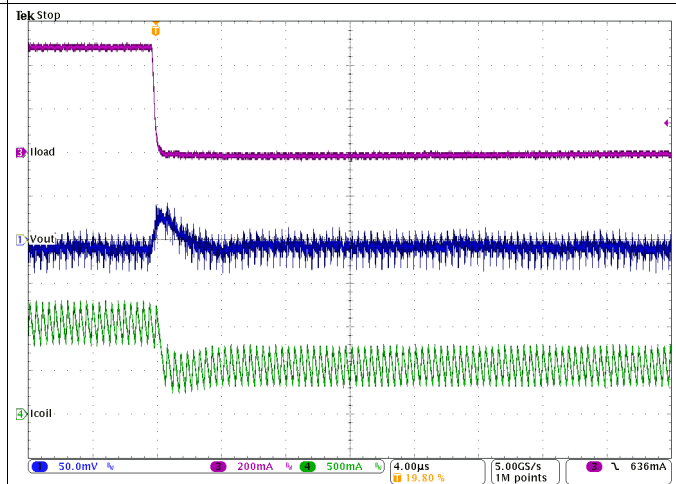

Figure 39. Load Transient Response, Falling Edge

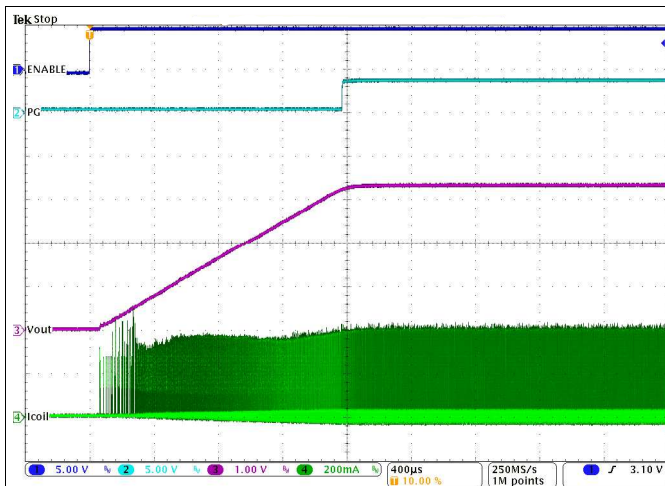

Figure 40. Start-Up Into 100 mA

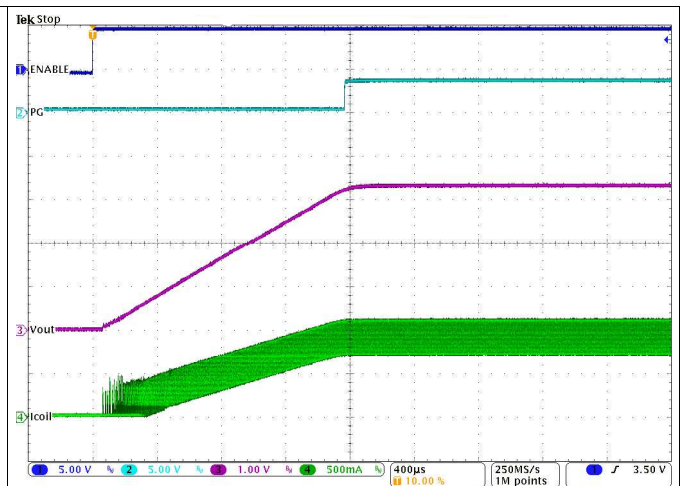
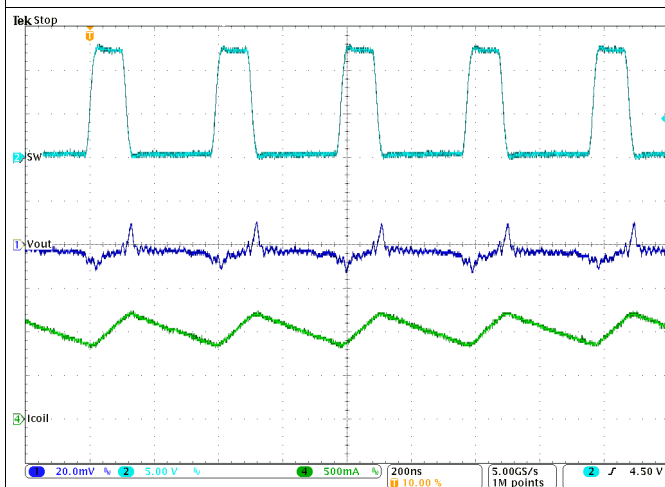
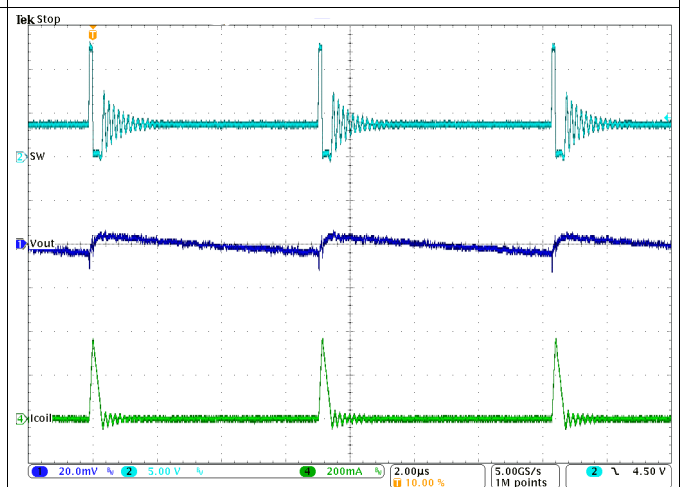

Figure 41. Start-Up Into 1 A



$I_{OUT} = 1 \text{ A}$

Figure 42. Typical Operation in PWM Mode



$I_{OUT} = 10 \text{ mA}$

Figure 43. Typical Operation in Power-Save Mode

9.3 System Examples

9.3.1 LED Power Supply

The TPS62150 can be used as a power supply for power LEDs. The FB pin can be easily set down to lower values than nominal by using the SS/TR pin. With that, the voltage drop on the sense resistor is low to avoid excessive power loss. Because this pin provides 2.5 μ A, the feedback pin voltage can be adjusted by an external resistor per Equation 15. This drop, proportional to the LED current, is used to regulate the output voltage (anode voltage) to a proper level to drive the LED. Both analog and PWM dimming are supported with the TPS62150. Figure 44 shows an application circuit, tested with analog dimming:

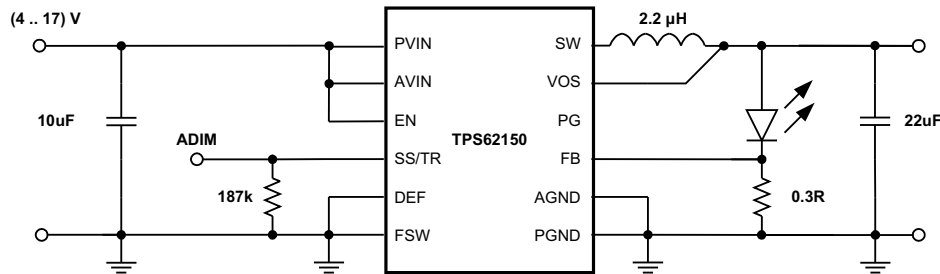

Copyright © 2016, Texas Instruments Incorporated

Figure 44. Single Power-LED Supply

The resistor at SS/TR sets the FB voltage to a level of about 300 mV, with a value calculated from Equation 15.

$$V_{FB} = 0.64 \times 2.5 \mu\text{A} \times R_{SS/TR} \quad (15)$$

The device now supplies a constant current, set by the resistor at the FB pin, by regulating the output voltage accordingly. The forward voltage requirement of the LED determines the minimum input voltage rating. More information is available in the *Using the TPS62150 as Step-Down LED Driver With Dimming* application report, SLVA451.

9.3.2 Active Output Discharge

The TPS62150A device pulls the PG pin Low when the device is shut down by EN, UVLO, or thermal shutdown. Connecting PG to V_{OUT} through a resistor can be used to discharge V_{OUT} in those cases (see Figure 45). The discharge rate can be adjusted by R3, which is also used to pull up the PG pin in normal operation. For reliability, keep the maximum current into the PG pin less than 10 mA.

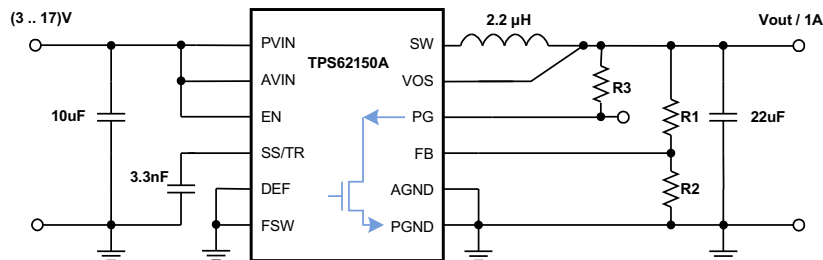

Copyright © 2016, Texas Instruments Incorporated

Figure 45. Discharge V_{OUT} Through PG Pin with TPS62150A

System Examples (continued)

9.3.3 Inverting Power Supply

The TPS6215x device can be used as an inverting power supply by rearranging external circuitry as shown in [Figure 46](#). As the former GND node now represents a voltage level below system ground, the voltage difference between V_{IN} and V_{OUT} must be limited for operation to the maximum supply voltage of 17 V (see [Equation 16](#)).

$$V_{IN} + |V_{OUT}| \leq V_{INmax} \quad (16)$$

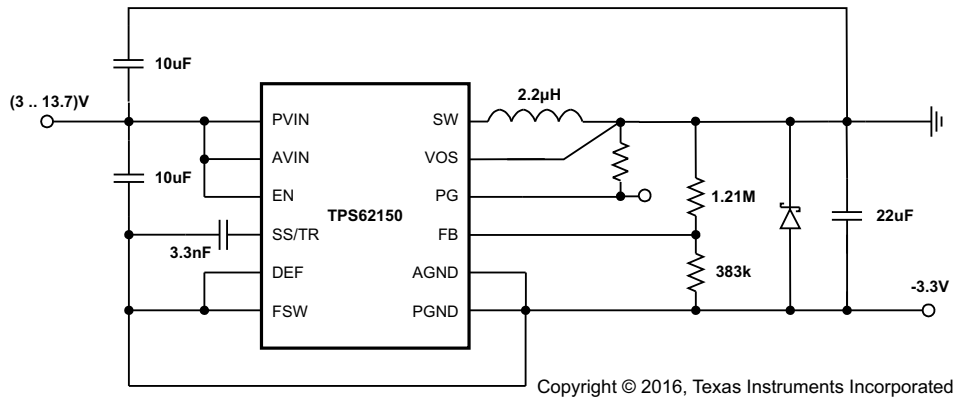

Figure 46. -3.3-V Inverting Power Supply

The transfer function of the inverting power supply configuration differs from the buck-mode transfer function, additionally incorporating a right half-plane zero. The loop stability must be adapted, and an output capacitance of at least 22 μF is recommended. A detailed design example is given in the *Using the TPS6215x in an Inverting Buck-Boost Topology* application report, [SLVA469](#).

9.3.4 Various Output Voltages

The following example circuits show how to use the various devices and configure the external circuitry to furnish different output voltages at 1 A.

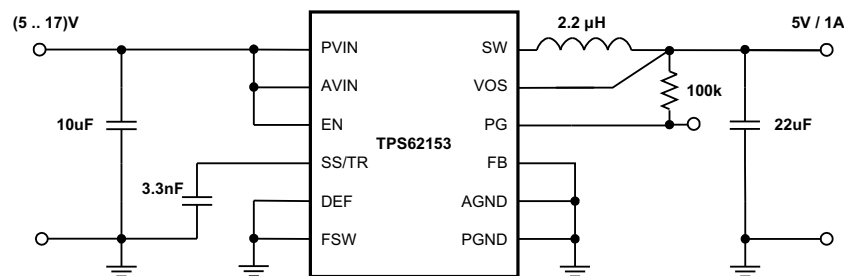
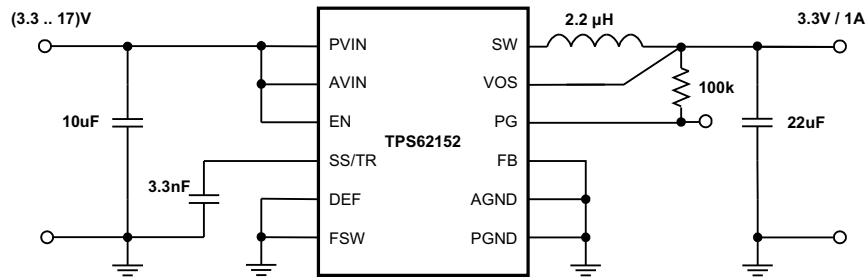

Figure 47. 5-V, 1-A Power Supply

System Examples (continued)



Copyright © 2016, Texas Instruments Incorporated

Figure 48. 3.3-V, 1-A Power Supply

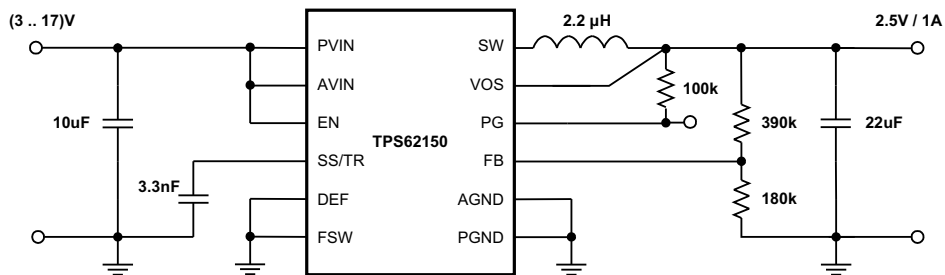

Copyright © 2016, Texas Instruments Incorporated

Figure 49. 2.5-V, 1-A Power Supply

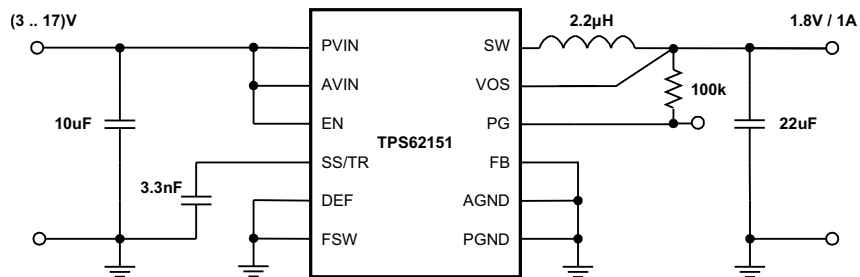

Copyright © 2016, Texas Instruments Incorporated

Figure 50. 1.8-V, 1-A Power Supply

System Examples (continued)

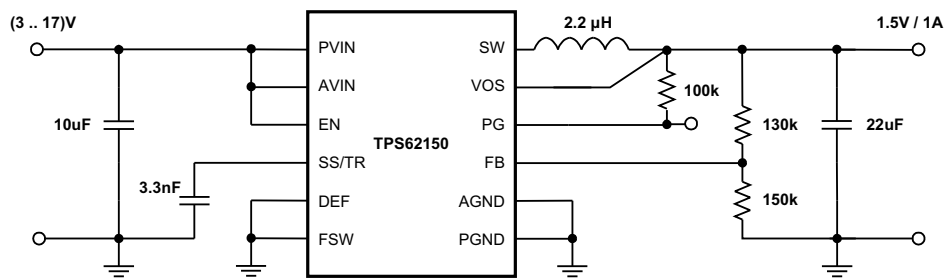

Copyright © 2016, Texas Instruments Incorporated

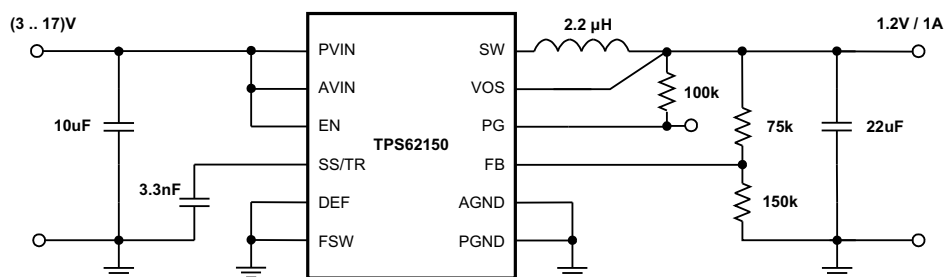
Figure 51. 1.5-V, 1-A Power Supply

Copyright © 2016, Texas Instruments Incorporated

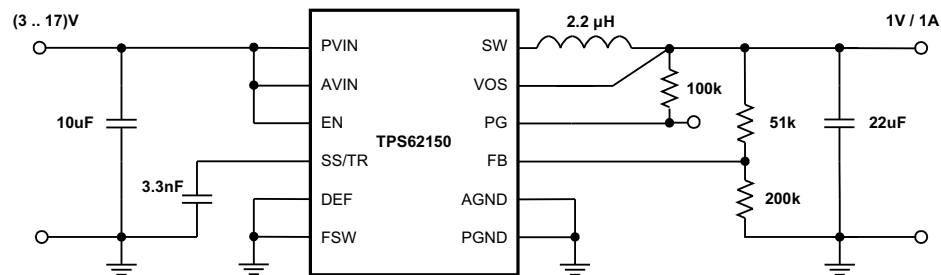
Figure 52. 1.2-V, 1-A Power Supply

Copyright © 2016, Texas Instruments Incorporated

Figure 53. 1-V, 1-A Power Supply

10 Power Supply Recommendations

The TPS6215x devices are designed to operate from a 3-V to 17-V input voltage supply. The output current of the input power supply must be rated according to the output voltage and the output current of the power rail application.

11 Layout

11.1 Layout Guidelines

Proper layout is critical for the operation of a switched-mode power supply, even more at high switching frequencies. Therefore, the PCB layout of the TPS6215x device demands careful attention to ensure operation and to get the performance specified. A poor layout can lead to issues like poor regulation (both line and load), stability and accuracy weaknesses, increased EMI radiation, and noise sensitivity.

See [Figure 54](#) for the recommended layout of the TPS6215x device, which is designed for common external ground connections. Both AGND (pin 6) and PGND (pins 15 and 16) are directly connected to the exposed thermal pad. On the PCB, the direct common-ground connection of AGND and PGND to the exposed thermal pad and the system ground (ground plane) is mandatory. Also, connect VOS (pin 14) in the shortest way to V_{OUT} at the output capacitor. To avoid noise coupling into the VOS line, this connection should be separated from the V_{OUT} power line and plane as shown in [Layout Example](#).

Provide low-inductance and -resistance paths for loops with high di/dt . Paths conducting the switched load current should be as short and wide as possible. Provide low-capacitance paths (with respect to all other nodes) for wires with high dv/dt . The input and output capacitance should be placed as close as possible to the IC pins, and parallel wiring over long distances as well as narrow traces should be avoided. Loops which conduct an alternating current should outline an area as small as possible, as this area is proportional to the energy radiated.

Sensitive nodes like FB (pin 5) and VOS (pin 14) must be connected with short wires and not near high dv/dt signals [for example, SW (pins 1, 2, and 3)]. As FB and VOS pins carry information about the output voltage, they should be connected as closely as possible to the actual output voltage (at the output capacitor). The capacitor on SS/TR (pin 9) and on AVIN (pin 19), as well as the FB resistors, R1 and R2, should be kept close to the IC and connect directly to those pins and the system ground plane.

The exposed thermal pad must be soldered to the circuit board for mechanical reliability and to achieve adequate power dissipation.

The recommended layout is implemented on the EVM and shown in its Users Guide, [SLVU437](#). Additionally, the EVM Gerber data are available for download here, [SLVC394](#).

11.2 Layout Example

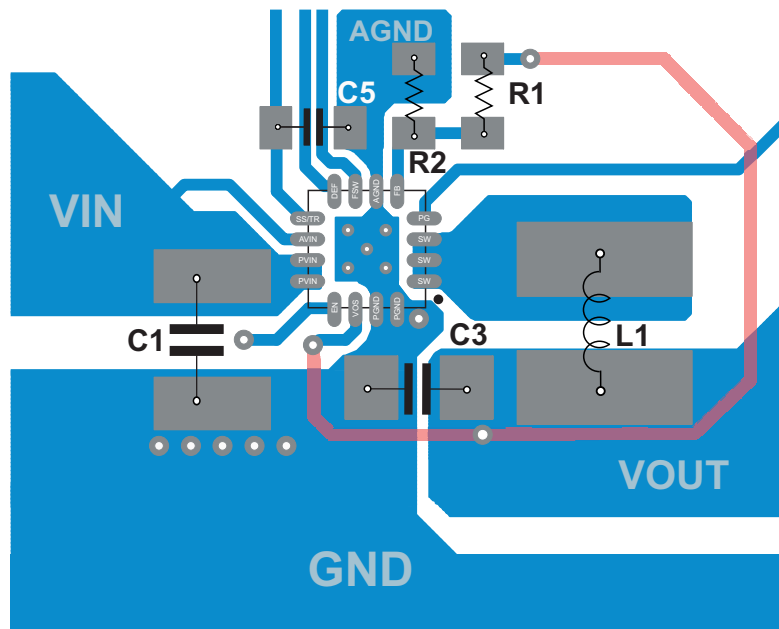

Figure 54. TPS6215x Example Layout

11.3 Thermal Considerations

Implementation of integrated circuits in low-profile and fine-pitch surface-mount packages typically requires special attention to power dissipation. Many system-dependent issues such as thermal coupling, airflow, added heat sinks, and convection surfaces, and the presence of other heat-generating components affect the power-dissipation limits of a given component.

Three basic approaches for enhancing thermal performance are listed below:

- Improving the power dissipation capability of the PCB design
- Improving the thermal coupling of the component to the PCB by soldering the exposed thermal pad
- Introducing airflow in the system

For more details on how to use the thermal parameters, see the *Thermal Characteristics of Linear and Logic Packages Using JEDEC PCB Designs* and *Semiconductor and IC Package Thermal Metrics* application reports, [SZZA017](#) and [SPRA953](#), respectively.

The TPS6215x devices are designed for a maximum operating junction temperature (T_J) of 125°C. Therefore, the maximum output power is limited by the power losses that can be dissipated over the actual thermal resistance, given by the package and the surrounding PCB structures. Because the thermal resistance of the package is fixed, increasing the size of the surrounding copper area and improving the thermal connection to the IC can reduce the thermal resistance. To get improved thermal behavior, it is recommended to use top-layer metal to connect the device with wide and thick metal lines. Internal ground layers can connect to vias directly under the IC for improved thermal performance.

If short-circuit or overload conditions are present, the device is protected by limiting internal power dissipation.

12 Device and Documentation Support

12.1 Device Support

12.1.1 Third-Party Products Disclaimer

TI'S PUBLICATION OF INFORMATION REGARDING THIRD-PARTY PRODUCTS OR SERVICES DOES NOT CONSTITUTE AN ENDORSEMENT REGARDING THE SUITABILITY OF SUCH PRODUCTS OR SERVICES OR A WARRANTY, REPRESENTATION OR ENDORSEMENT OF SUCH PRODUCTS OR SERVICES, EITHER ALONE OR IN COMBINATION WITH ANY TI PRODUCT OR SERVICE.

12.2 Documentation Support

12.2.1 Related Documentation

For related documentation, see the following:

- *Optimizing Transient Response of Internally Compensated dc-dc Converters With Feedforward Capacitor*, [SLVA289](#)
- *Using the TPS62150 as Step-Down LED Driver With Dimming*, [SLVA451](#)
- *Optimizing the TPS62130/40/50/60/70 Output Filter*, [SLVA463](#)
- *Using a Feedforward Capacitor to Improve Stability and Bandwidth of TPS62130/40/50/60/70*, [SLVA466](#)
- *Using the TPS6215x in an Inverting Buck-Boost Topology*, [SLVA469](#)
- *TPS62130/40/50 Sequencing and Tracking*, [SLVA470](#)
- *Voltage Margining Using the TPS62130*, [SLVA489](#)
- *TPS62130EVM-505, TPS62140EVM-505, and TPS62150EVM-505 Evaluation Modules User's Guide*, [SLVU437](#)
- *Semiconductor and IC Package Thermal Metrics*, [SPRA953](#)
- *Thermal Characteristics of Linear and Logic Packages Using JEDEC PCB Designs*, [SZZA017](#)

12.3 Related Links

The table below lists quick access links. Categories include technical documents, support and community resources, tools and software, and quick access to sample or buy.

Table 6. Related Links

| Parts | Product Folder | Sample & Buy | Technical Documents | Tools & Software | Support & Community |
|-----------|----------------------------|----------------------------|----------------------------|----------------------------|----------------------------|
| TPS62150 | Click here | Click here | Click here | Click here | Click here |
| TPS62150A | Click here | Click here | Click here | Click here | Click here |
| TPS62151 | Click here | Click here | Click here | Click here | Click here |
| TPS62152 | Click here | Click here | Click here | Click here | Click here |
| TPS62153 | Click here | Click here | Click here | Click here | Click here |

12.4 Receiving Notification of Documentation Updates

To receive notification of documentation updates, navigate to the device product folder on ti.com. In the upper right corner, click on *Alert me* to register and receive a weekly digest of any product information that has changed. For change details, review the revision history included in any revised document.

12.5 Community Resources

The following links connect to TI community resources. Linked contents are provided "AS IS" by the respective contributors. They do not constitute TI specifications and do not necessarily reflect TI's views; see TI's [Terms of Use](#).

TI E2E™ Online Community *TI's Engineer-to-Engineer (E2E) Community*. Created to foster collaboration among engineers. At e2e.ti.com, you can ask questions, share knowledge, explore ideas and help solve problems with fellow engineers.

Design Support *TI's Design Support* Quickly find helpful E2E forums along with design support tools and contact information for technical support.

12.6 Trademarks

DCS-Control, E2E are trademarks of Texas Instruments.
All other trademarks are the property of their respective owners.

12.7 Electrostatic Discharge Caution



These devices have limited built-in ESD protection. The leads should be shorted together or the device placed in conductive foam during storage or handling to prevent electrostatic damage to the MOS gates.

12.8 Glossary

[SLYZ022](#) — *TI Glossary*.

This glossary lists and explains terms, acronyms, and definitions.

13 Mechanical, Packaging, and Orderable Information

The following pages include mechanical, packaging, and orderable information. This information is the most-current data available for the designated devices. This data is subject to change without notice and without revision of this document. For browser-based versions of this data sheet, see the left-hand navigation pane.

PACKAGING INFORMATION

| Orderable Device | Status (1) | Package Type | Package Drawing | Pins | Package Qty | Eco Plan (2) | Lead/Ball Finish (6) | MSL Peak Temp (3) | Op Temp (°C) | Device Marking (4/5) | Samples |
|------------------|---------------|--------------|--------------------|------|----------------|----------------------------|-------------------------|----------------------|--------------|-------------------------|-------------------------|
| TPS62150ARGTR | ACTIVE | VQFN | RGT | 16 | 3000 | Green (RoHS & no Sb/Br) | CU NIPDAU | Level-2-260C-1 YEAR | -40 to 125 | PA8I | Samples |
| TPS62150ARGTT | ACTIVE | VQFN | RGT | 16 | 250 | Green (RoHS & no Sb/Br) | CU NIPDAU | Level-2-260C-1 YEAR | -40 to 125 | PA8I | Samples |
| TPS62150RGTR | ACTIVE | VQFN | RGT | 16 | 3000 | Green (RoHS & no Sb/Br) | CU NIPDAU | Level-2-260C-1 YEAR | -40 to 125 | QUA | Samples |
| TPS62150RGTT | ACTIVE | VQFN | RGT | 16 | 250 | Green (RoHS & no Sb/Br) | CU NIPDAU | Level-2-260C-1 YEAR | -40 to 125 | QUA | Samples |
| TPS62151RGTR | ACTIVE | VQFN | RGT | 16 | 3000 | Green (RoHS & no Sb/Br) | CU NIPDAU | Level-2-260C-1 YEAR | -40 to 125 | QWO | Samples |
| TPS62151RGTT | ACTIVE | VQFN | RGT | 16 | 250 | Green (RoHS & no Sb/Br) | CU NIPDAU | Level-2-260C-1 YEAR | -40 to 125 | QWO | Samples |
| TPS62152RGTR | ACTIVE | VQFN | RGT | 16 | 3000 | Green (RoHS & no Sb/Br) | CU NIPDAU | Level-2-260C-1 YEAR | -40 to 125 | QWP | Samples |
| TPS62152RGTT | ACTIVE | VQFN | RGT | 16 | 250 | Green (RoHS & no Sb/Br) | CU NIPDAU | Level-2-260C-1 YEAR | -40 to 125 | QWP | Samples |
| TPS62153RGTR | ACTIVE | VQFN | RGT | 16 | 3000 | Green (RoHS & no Sb/Br) | CU NIPDAU | Level-2-260C-1 YEAR | -40 to 125 | QWQ | Samples |
| TPS62153RGTT | ACTIVE | VQFN | RGT | 16 | 250 | Green (RoHS & no Sb/Br) | CU NIPDAU | Level-2-260C-1 YEAR | -40 to 125 | QWQ | Samples |

(1) The marketing status values are defined as follows:

ACTIVE: Product device recommended for new designs.

LIFEBUY: TI has announced that the device will be discontinued, and a lifetime-buy period is in effect.

NRND: Not recommended for new designs. Device is in production to support existing customers, but TI does not recommend using this part in a new design.

PREVIEW: Device has been announced but is not in production. Samples may or may not be available.

OBsolete: TI has discontinued the production of the device.

(2) **RoHS:** TI defines "RoHS" to mean semiconductor products that are compliant with the current EU RoHS requirements for all 10 RoHS substances, including the requirement that RoHS substance do not exceed 0.1% by weight in homogeneous materials. Where designed to be soldered at high temperatures, "RoHS" products are suitable for use in specified lead-free processes. TI may reference these types of products as "Pb-Free".

RoHS Exempt: TI defines "RoHS Exempt" to mean products that contain lead but are compliant with EU RoHS pursuant to a specific EU RoHS exemption.

Green: TI defines "Green" to mean the content of Chlorine (Cl) and Bromine (Br) based flame retardants meet JS709B low halogen requirements of <=1000ppm threshold. Antimony trioxide based flame retardants must also meet the <=1000ppm threshold requirement.

(3) MSL, Peak Temp. - The Moisture Sensitivity Level rating according to the JEDEC industry standard classifications, and peak solder temperature.

(4) There may be additional marking, which relates to the logo, the lot trace code information, or the environmental category on the device.

(5) Multiple Device Markings will be inside parentheses. Only one Device Marking contained in parentheses and separated by a "~" will appear on a device. If a line is indented then it is a continuation of the previous line and the two combined represent the entire Device Marking for that device.

(6) Lead/Ball Finish - Orderable Devices may have multiple material finish options. Finish options are separated by a vertical ruled line. Lead/Ball Finish values may wrap to two lines if the finish value exceeds the maximum column width.

Important Information and Disclaimer:The information provided on this page represents TI's knowledge and belief as of the date that it is provided. TI bases its knowledge and belief on information provided by third parties, and makes no representation or warranty as to the accuracy of such information. Efforts are underway to better integrate information from third parties. TI has taken and continues to take reasonable steps to provide representative and accurate information but may not have conducted destructive testing or chemical analysis on incoming materials and chemicals. TI and TI suppliers consider certain information to be proprietary, and thus CAS numbers and other limited information may not be available for release.

In no event shall TI's liability arising out of such information exceed the total purchase price of the TI part(s) at issue in this document sold by TI to Customer on an annual basis.

OTHER QUALIFIED VERSIONS OF TPS62150A, TPS62152 :

- Automotive: [TPS62150A-Q1](#), [TPS62152-Q1](#)

NOTE: Qualified Version Definitions:

- Automotive - Q100 devices qualified for high-reliability automotive applications targeting zero defects

TAPE AND REEL INFORMATION

QUADRANT ASSIGNMENTS FOR PIN 1 ORIENTATION IN TAPE

*All dimensions are nominal

| Device | Package Type | Package Drawing | Pins | SPQ | Reel Diameter (mm) | Reel Width W1 (mm) | A0 (mm) | B0 (mm) | K0 (mm) | P1 (mm) | W (mm) | Pin1 Quadrant |
|---------------|--------------|-----------------|------|------|--------------------|--------------------|---------|---------|---------|---------|--------|---------------|
| TPS62150ARGTR | VQFN | RGT | 16 | 3000 | 330.0 | 12.4 | 3.3 | 3.3 | 1.1 | 8.0 | 12.0 | Q2 |
| TPS62150ARGTT | VQFN | RGT | 16 | 250 | 180.0 | 12.4 | 3.3 | 3.3 | 1.1 | 8.0 | 12.0 | Q2 |
| TPS62150RGTR | VQFN | RGT | 16 | 3000 | 330.0 | 12.4 | 3.3 | 3.3 | 1.1 | 8.0 | 12.0 | Q2 |
| TPS62150RGTT | VQFN | RGT | 16 | 250 | 180.0 | 12.4 | 3.3 | 3.3 | 1.1 | 8.0 | 12.0 | Q2 |
| TPS62151RGTR | VQFN | RGT | 16 | 3000 | 330.0 | 12.4 | 3.3 | 3.3 | 1.1 | 8.0 | 12.0 | Q2 |
| TPS62151RGTT | VQFN | RGT | 16 | 250 | 180.0 | 12.4 | 3.3 | 3.3 | 1.1 | 8.0 | 12.0 | Q2 |
| TPS62152RGTR | VQFN | RGT | 16 | 3000 | 330.0 | 12.4 | 3.3 | 3.3 | 1.1 | 8.0 | 12.0 | Q2 |
| TPS62152RGTT | VQFN | RGT | 16 | 250 | 180.0 | 12.4 | 3.3 | 3.3 | 1.1 | 8.0 | 12.0 | Q2 |
| TPS62153RGTR | VQFN | RGT | 16 | 3000 | 330.0 | 12.4 | 3.3 | 3.3 | 1.1 | 8.0 | 12.0 | Q2 |
| TPS62153RGTT | VQFN | RGT | 16 | 250 | 180.0 | 12.4 | 3.3 | 3.3 | 1.1 | 8.0 | 12.0 | Q2 |

TAPE AND REEL BOX DIMENSIONS

*All dimensions are nominal

| Device | Package Type | Package Drawing | Pins | SPQ | Length (mm) | Width (mm) | Height (mm) |
|---------------|--------------|-----------------|------|------|-------------|------------|-------------|
| TPS62150ARGTR | VQFN | RGT | 16 | 3000 | 367.0 | 367.0 | 35.0 |
| TPS62150ARGTT | VQFN | RGT | 16 | 250 | 210.0 | 185.0 | 35.0 |
| TPS62150RGTR | VQFN | RGT | 16 | 3000 | 367.0 | 367.0 | 35.0 |
| TPS62150RGTT | VQFN | RGT | 16 | 250 | 210.0 | 185.0 | 35.0 |
| TPS62151RGTR | VQFN | RGT | 16 | 3000 | 367.0 | 367.0 | 35.0 |
| TPS62151RGTT | VQFN | RGT | 16 | 250 | 210.0 | 185.0 | 35.0 |
| TPS62152RGTR | VQFN | RGT | 16 | 3000 | 367.0 | 367.0 | 35.0 |
| TPS62152RGTT | VQFN | RGT | 16 | 250 | 210.0 | 185.0 | 35.0 |
| TPS62153RGTR | VQFN | RGT | 16 | 3000 | 367.0 | 367.0 | 35.0 |
| TPS62153RGTT | VQFN | RGT | 16 | 250 | 210.0 | 185.0 | 35.0 |

RGT 16

GENERIC PACKAGE VIEW

VQFN - 1 mm max height

PLASTIC QUAD FLATPACK - NO LEAD

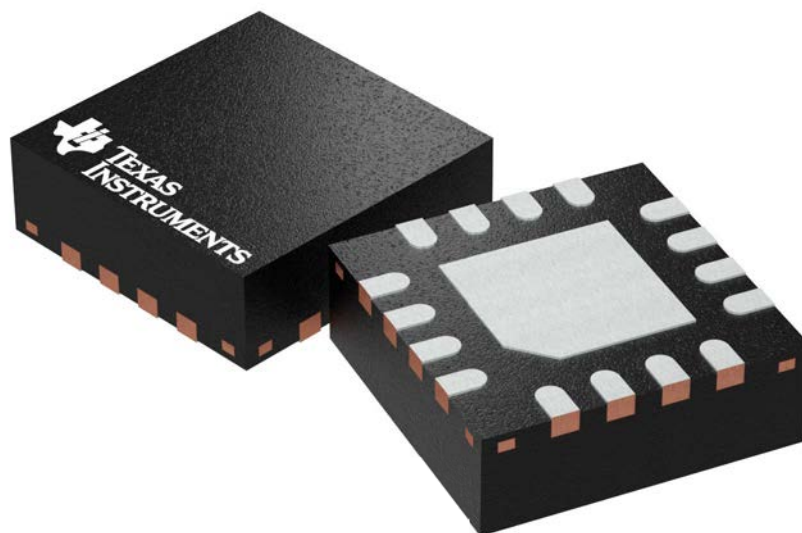

Images above are just a representation of the package family, actual package may vary.
Refer to the product data sheet for package details.

4203495/1

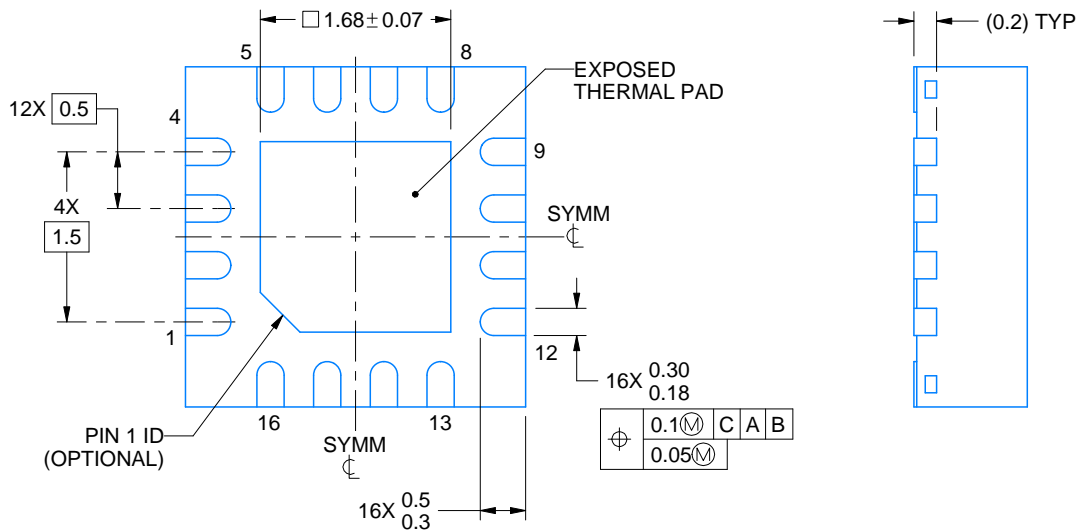
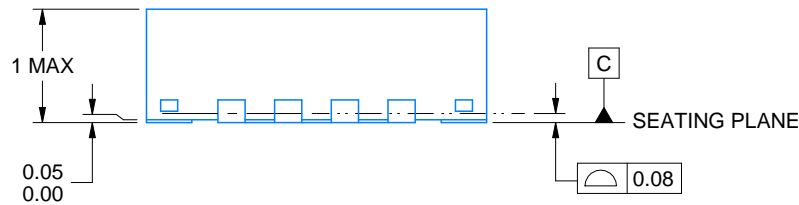
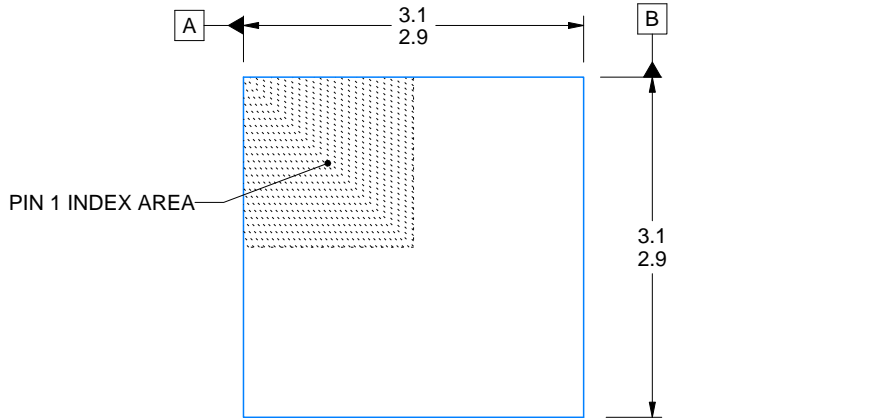
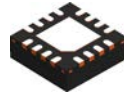

4222419/B 11/2016

NOTES:

1. All linear dimensions are in millimeters. Any dimensions in parenthesis are for reference only. Dimensioning and tolerancing per ASME Y14.5M.
2. This drawing is subject to change without notice.
3. The package thermal pad must be soldered to the printed circuit board for thermal and mechanical performance.

IMPORTANT NOTICE AND DISCLAIMER

TI PROVIDES TECHNICAL AND RELIABILITY DATA (INCLUDING DATASHEETS), DESIGN RESOURCES (INCLUDING REFERENCE DESIGNS), APPLICATION OR OTHER DESIGN ADVICE, WEB TOOLS, SAFETY INFORMATION, AND OTHER RESOURCES "AS IS" AND WITH ALL FAULTS, AND DISCLAIMS ALL WARRANTIES, EXPRESS AND IMPLIED, INCLUDING WITHOUT LIMITATION ANY IMPLIED WARRANTIES OF MERCHANTABILITY, FITNESS FOR A PARTICULAR PURPOSE OR NON-INFRINGEMENT OF THIRD PARTY INTELLECTUAL PROPERTY RIGHTS.

These resources are intended for skilled developers designing with TI products. You are solely responsible for (1) selecting the appropriate TI products for your application, (2) designing, validating and testing your application, and (3) ensuring your application meets applicable standards, and any other safety, security, or other requirements. These resources are subject to change without notice. TI grants you permission to use these resources only for development of an application that uses the TI products described in the resource. Other reproduction and display of these resources is prohibited. No license is granted to any other TI intellectual property right or to any third party intellectual property right. TI disclaims responsibility for, and you will fully indemnify TI and its representatives against, any claims, damages, costs, losses, and liabilities arising out of your use of these resources.

TI's products are provided subject to TI's Terms of Sale (www.ti.com/legal/termsofsale.html) or other applicable terms available either on ti.com or provided in conjunction with such TI products. TI's provision of these resources does not expand or otherwise alter TI's applicable warranties or warranty disclaimers for TI products.

Mailing Address: Texas Instruments, Post Office Box 655303, Dallas, Texas 75265
Copyright © 2019, Texas Instruments Incorporated

Looking for pricing, stock, or lifecycle information?

Click below to explore more details on WIN SOURCE:

 [View TPS62150ARGTT](#) on WIN SOURCE

 [Texas Instruments](#) Information

Optimize Your Supply Chain with WIN SOURCE Solutions

-  Global Sourcing Solution
-  Obsolete Management
-  Cost Control Management
-  Shortage Management
-  Alternative Solution
-  Excess Inventory Management