

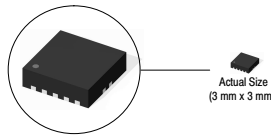

**THE DATASHEET OF
TPS71319DRCTG4**





Dual 250 mA Output, UltraLow Noise, High PSRR, Low-Dropout Linear Regulator with Integrated SVS

FEATURES

- Dual 250 mA High-Performance RF LDOs
- Integrated Supply Voltage Supervisor Monitors V_{OUT2}
- Available in Fixed and Adjustable Voltage Options (1.2 V to 5.5 V)
- High PSRR: 65 dB at 10 kHz
- UltraLow Noise: 32 μVrms
- Fast Start-Up Time: 60 μs
- Stable with 2.2 μF Ceramic Capacitor
- Excellent Load/Line Transient Response
- Very Low Dropout Voltage: 125 mV at 250 mA
- Independent Enable Pins
- Thermal Shutdown and Independent Current Limit
- Available in Thermally-Enhanced SON Package: 3mm x 3mm x 1mm

APPLICATIONS

- Cellular and Cordless Phones
- Wireless PDA/Handheld Products
- PCMCIA/Wireless LAN Applications
- Digital Camera/Camcorder/Internet Audio
- DSP/FPGA/ASIC/Controllers and Processors

DESCRIPTION

The TPS713xx family of low-dropout (LDO) voltage regulators is tailored to noise-sensitive and RF applications. These products feature dual 250 mA LDOs with ultralow noise, high power-supply rejection ratio (PSRR), and fast transient and start-up response. These devices also feature an integrated supply voltage supervisor (SVS) that monitors the voltage at OUT2 and will assert if the voltage falls to 95% (typical) of the measured output. Each regulator output is stable with low-cost 2.2 μF ceramic output capacitors and features very low dropout voltages (125 mV typical at 250 mA). Each regulator achieves fast start-up times (approximately 60 μs with a 0.001 μF bypass capacitor) while consuming very low quiescent current (300 μA typical with both outputs enabled). When the device is placed in standby mode, the supply current is reduced to less than 0.3 μA typical. Each regulator exhibits approximately 32 μVrms of output voltage noise with $V_{OUT} = 2.8 \text{ V}$ and a 0.01 μF noise reduction (NR) capacitor. Applications with analog components that are noise-sensitive, such as portable RF electronics, will benefit from high PSRR, low noise, and fast line and load transient features. The TPS713xx family is offered in a thin 3mm x 3mm SON package and is fully specified from -40°C to $+125^\circ\text{C}$ (T_J).

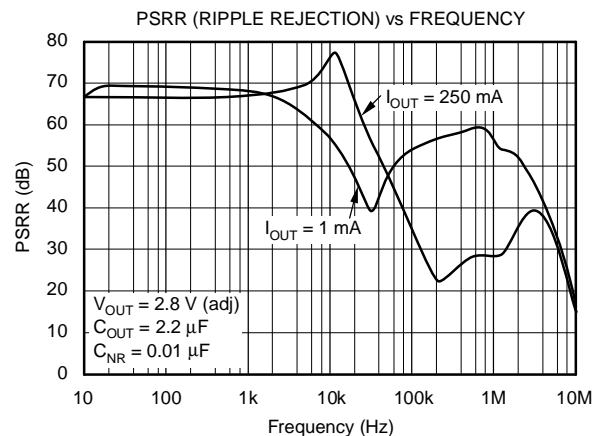
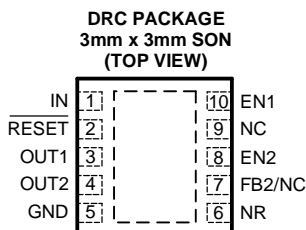

Please be aware that an important notice concerning availability, standard warranty, and use in critical applications of Texas Instruments semiconductor products and disclaimers thereto appears at the end of this data sheet.



This integrated circuit can be damaged by ESD. Texas Instruments recommends that all integrated circuits be handled with appropriate precautions. Failure to observe proper handling and installation procedures can cause damage.

ESD damage can range from subtle performance degradation to complete device failure. Precision integrated circuits may be more susceptible to damage because very small parametric changes could cause the device not to meet its published specifications.

ORDERING INFORMATION⁽¹⁾

PRODUCT	VOLTAGE (T _J)		PACKAGE-LEAD (DESIGNATOR)	SPECIFIED TEMPERATURE RANGE (T _J)	PACKAGE MARKING	ORDERING NUMBER	TRANSPORT MEDIA, QUANTITY
	V _{OUT1}	V _{OUT2}					
TPS71319	1.8 V	Adjustable	SON-10 (DRC)	-40°C to +125°C	ARP	TPS71319DRCT	Tape and Reel, 250
						TPS71319DRCR	Tape and Reel, 3000
TPS71334	3.3 V	Adjustable	SON-10 (DRC)	-40°C to +125°C	ARO	TPS71334DRCT	Tape and Reel, 250
						TPS71334DRCR	Tape and Reel, 3000

(1) For the most current package and ordering information, see the Package Ordering Addendum located at the end of this data sheet.

ABSOLUTE MAXIMUM RATINGS

over operating junction temperature range unless otherwise noted⁽¹⁾

	TPS713xx	UNIT
V _{IN} range	-0.3 to 6.0	V
V _{RESET} range	-0.3 to V _{IN} + 0.3	V
V _{EN1} , V _{EN2} range	-0.3 to V _{IN} + 0.3	V
V _{OUT} range	-0.3 to 6.0	V
Peak output current	Internally limited	
Output short-circuit duration	Indefinite	
Continuous total power dissipation	See Dissipation Ratings Table	
Junction temperature range, T _J	-40 to +150	°C
Storage temperature range	-65 to +150	°C
ESD rating, HBM	2	kV
ESD rating, CDM	500	V

(1) Stresses beyond those listed under *absolute maximum ratings* may cause permanent damage to the device. These are stress ratings only, and functional operation of the device at these or any other conditions beyond those indicated under the Electrical Characteristics is not implied. Exposure to absolute maximum rated conditions for extended periods may affect device reliability.

POWER DISSIPATION RATINGS

BOARD	PACKAGE	R _{θJC}	R _{θJA}	DERATING FACTOR ABOVE T _A = 25°C	T _A ≤ 25°C POWER RATING	T _A = 70°C POWER RATING	T _A = 85°C POWER RATING
High-K ⁽¹⁾	DRC	48	52	19 mW/°C	1.92 W	1.06 W	0.77 W

(1) The JEDEC High-K (2s2p) board design used to derive this data was a 3 inch x 3 inch, multilayer board with 1-ounce internal power and ground planes and 2-ounce copper traces on the top and bottom of the board.

ELECTRICAL CHARACTERISTICS

Over operating temperature range ($T_J = -40^\circ\text{C}$ to $+125^\circ\text{C}$), V_{IN} = highest $V_{OUT(nom)}$ + 1.0 V or 2.7 V (whichever is greater), $I_{OUT} = 1$ mA, $V_{EN1,2} = 1.2$ V, $C_{OUT} = 10$ μF , $C_{NR} = 0.01$ μF , and adjustable LDOs are tested at $V_{OUT} = 3.0$ V, unless otherwise noted. Typical values are at $T_J = 25^\circ\text{C}$.

PARAMETER		TEST CONDITIONS	MIN	TYP	MAX	UNIT	
V_{IN}	Input voltage range ⁽¹⁾		2.7		5.5	V	
V_{FB}	Internal reference (adjustable LDOs)		1.200	1.225	1.250	V	
V_{OUT}	Output voltage range (adjustable LDOs)		V_{FB}	5.5 - V_{DO}		V	
	Accuracy ⁽¹⁾	Nominal	$T_J = 25^\circ\text{C}$, $I_{OUT} = 0$ mA		-1.5	+1.5	%
Over V_{IN} , I_{OUT} , and T		$V_{OUT} + 1.0$ V $\leq V_{IN} \leq 5.5$ V, 0 $\mu\text{A} \leq I_{OUT} \leq 250$ mA		-3	± 1	+3	
$\Delta V_{OUT}/\Delta V_{IN}$	Line regulation ⁽¹⁾	$V_{OUT} + 1.0$ V $\leq V_{IN} \leq 5.5$ V		0.05		%/V	
$\Delta V_{OUT}/\Delta I_{OUT}$	Load regulation	0 $\mu\text{A} \leq I_{OUT} \leq 250$ mA		0.8		%/mA	
V_{DO}	Dropout voltage ⁽²⁾ ($V_{IN} = V_{OUT(nom)} - 0.1$ V)	2.8 V, 2.85 V Adjustable	$I_{OUT1} = I_{OUT2} = 250$ mA		125	230	mV
I_{CL}	Output current limit	$V_{OUT} = 0.9 \times V_{OUT(nom)}$		400	600	800	mA
I_{GND}	Ground pin current	One LDO enabled	$I_{OUT} = 1$ mA (enabled channel)		190	250	μA
		Both LDOs enabled	$I_{OUT1} = I_{OUT2} = 1$ mA to 250 mA		300	600	
I_{SHDN}	Shutdown current ⁽³⁾	$V_{EN} \leq 0.4$ V, 0 V $\leq V_{IN} \leq 5.5$ V, RESET open		0.3	2.0	μA	
I_{FB}	FB pin current (adjustable LDOs)			0.1	1	μA	
V_n	Output noise voltage, BW = 10 Hz - 100 kHz	No C_{NR} , $I_{OUT} = 250$ mA		$80.0 \times V_{OUT}$		μV_{rms}	
		$C_{NR} = 0.01$ μF , $I_{OUT} = 250$ mA		$11.8 \times V_{OUT}$			
PSRR	Power-supply rejection ratio (ripple rejection)	$f = 100$ Hz, $I_{OUT} = 250$ mA		65		dB	
		$f = 10$ kHz, $I_{OUT} = 250$ mA		65			
t_{STR}	Startup time	$V_{OUT} = 2.85$ V, $R_L = 30\Omega$, $C_{NR} = 0.001$ μF		60		μs	
V_{IH}	Enable threshold high (EN1, EN2)			1.2	V_{IN}	V	
V_{IL}	Enable threshold low (EN1, EN2)			0	0.4	V	
I_{EN}	Enable pin current (EN1, EN2)	$V_{IN} = V_{EN} = 5.5$ V		-1	1	μA	
	Minimum V_{IN} for valid RESET	$I_{RESET} = 10$ μA		0.6		V	
$V_{RESET, LO}$	RESET output low voltage	$I_{RESET} = 1$ mA			0.4	V	
$I_{LKG, RESET}$	RESET leakage current	$V_{IN} = V_{RESET} = 5.5$ V		10	500	nA	
V_{IT}	RESET threshold voltage	V_{OUT2} falling ⁽⁴⁾		92.5	97.5	% V_{OUT}	
V_{HYS}	RESET threshold hysteresis	V_{OUT2} rising ⁽⁴⁾		0.5		% V_{OUT}	
T_D	RESET delay time			50	100	200	ms
T_P	RESET propagation delay			10		μs	
T_{SD}	Thermal shutdown temperature	Shutdown	Temp increasing		+160	$^\circ\text{C}$	
		Reset	Temp decreasing		+140		
UVLO	Under-voltage lockout threshold	V_{IN} rising		2.25	2.65	V	
	Under-voltage lockout hysteresis	V_{IN} falling		100		mV	

(1) Minimum $V_{IN} = V_{OUT} + V_{DO}$ or 2.7 V, whichever is greater.

(2) V_{DO} is not measured for 1.8 V regulators since minimum $V_{IN} = 2.7$ V.

(3) For the adjustable version, this applies only after V_{IN} is applied; then V_{EN} transitions from high to low.

(4) RESET threshold and hysteresis is a percentage of the measured output.

FUNCTIONAL BLOCK DIAGRAM

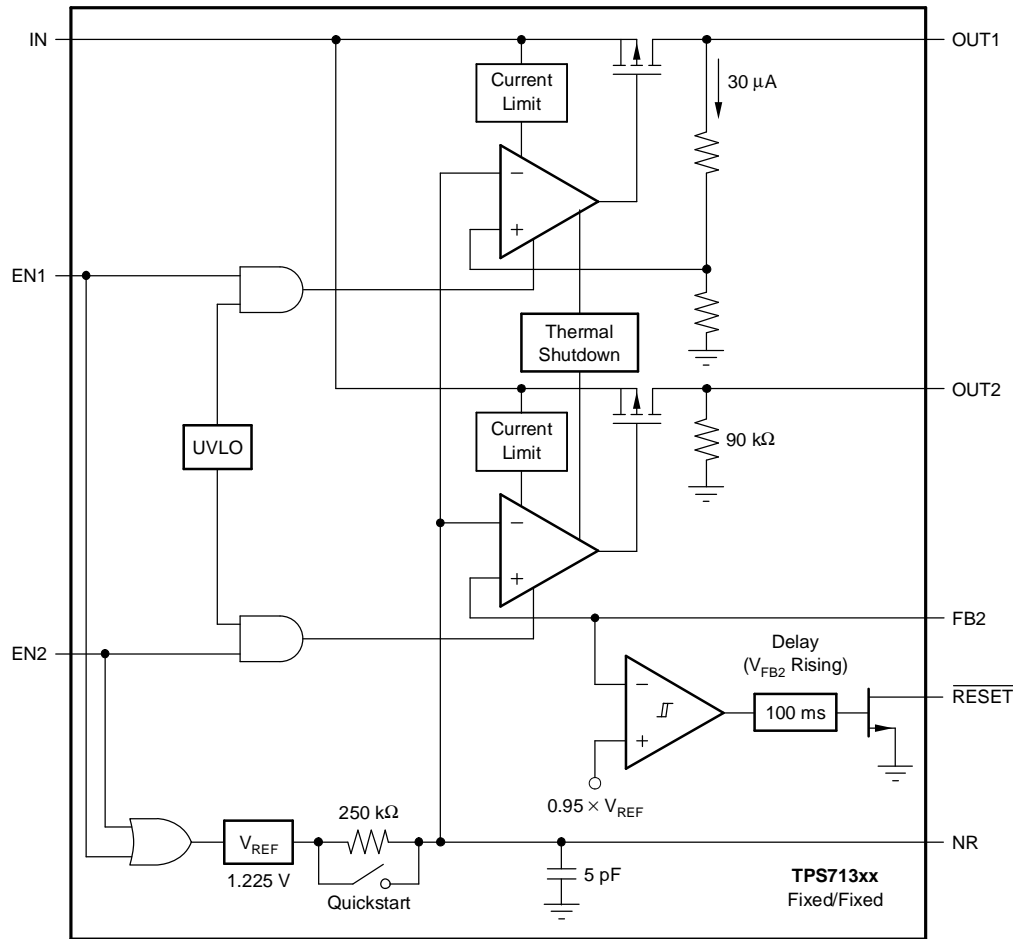

Table 1. TERMINAL FUNCTIONS

TERMINAL		DESCRIPTION
NAME	DRC	
IN	1	Unregulated input supply. A 0.1 μF capacitor should be connected from IN to GND.
GND	5, Pad	Ground
OUT1	3	Output of the regulator. A small 2.2 μF ceramic capacitor is required from this pin to ground to assure stability.
OUT2	4	Same as OUT1 but for LDO2.
EN1	10	Driving the enable pin (EN) high turns on LDO1. Driving this pin low puts LDO1 into shutdown mode, reducing operating current. The enable pin should be connected to IN if not used.
EN2	8	Same as EN1 but controls LDO2.
NC	9	No connection.
FB2/NC	7	Feedback for CH2 adjustable version; no connection for non-adjustable CH2.
NR	6	Noise reduction pin; connect an external bypass capacitor to reduce LDO output noise.
RESET	2	Open-drain reset output; monitors OUT2. A 10 kΩ to 1 MΩ pull-up resistor is suitable for most applications. The open-drain RESET pull-up voltage should not exceed V _{DD} + 0.3 V.

TYPICAL CHARACTERISTICS

For all voltage versions at $T_J = 25^\circ\text{C}$, $V_{IN} = V_{OUT(nom)} + 1\text{ V}$, $I_{OUT} = 1\text{ mA}$, $V_{EN} = 1.2\text{ V}$, $C_{OUT} = 2.2\text{ }\mu\text{F}$, and $C_{NR} = 0.01\text{ }\mu\text{F}$, unless otherwise noted.

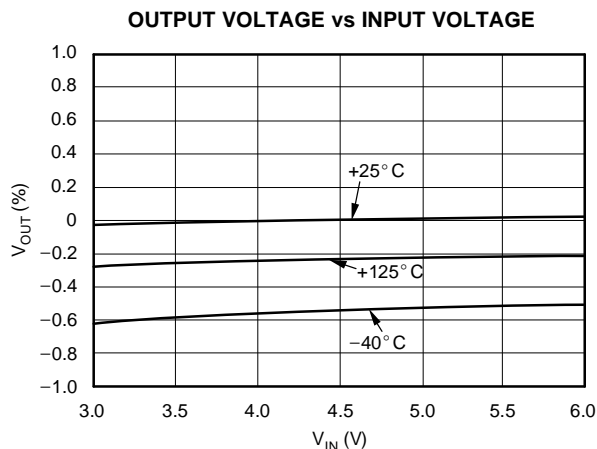

Figure 1.

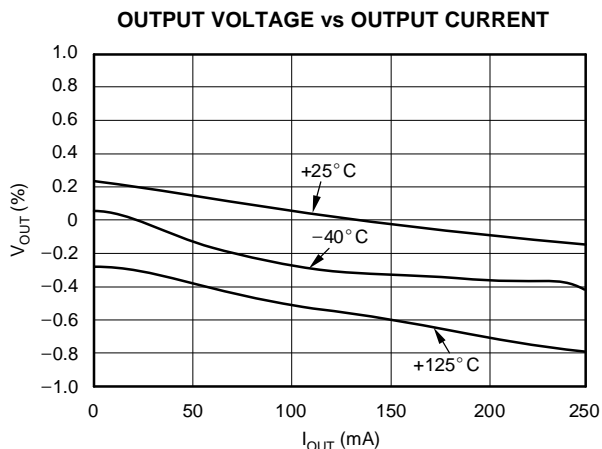

Figure 2.

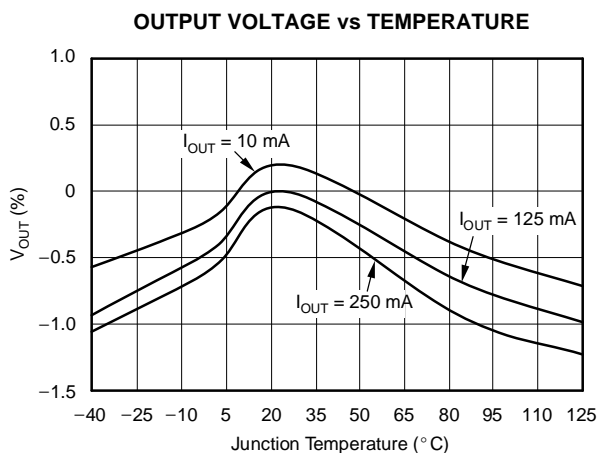

Figure 3.

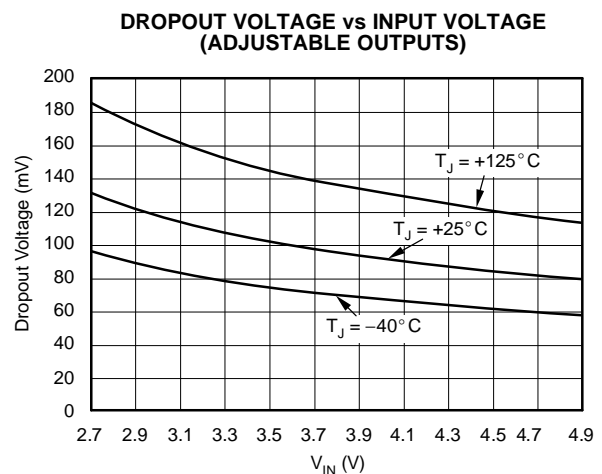

Figure 4.

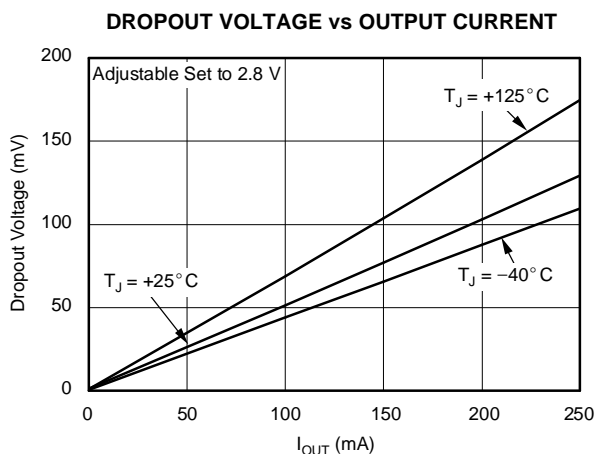

Figure 5.

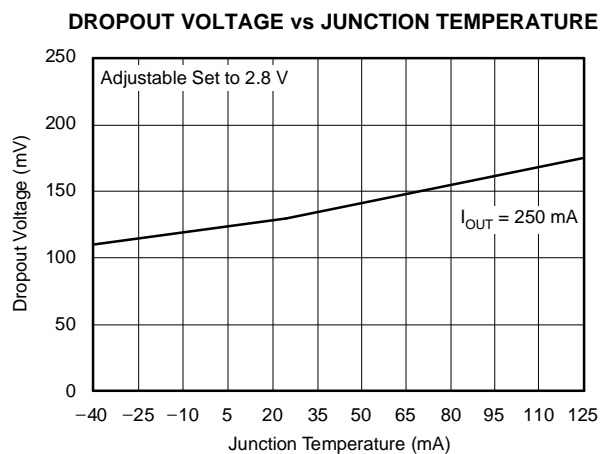

Figure 6.

TYPICAL CHARACTERISTICS (continued)

For all voltage versions at $T_J = 25^\circ\text{C}$, $V_{IN} = V_{OUT(nom)} + 1\text{ V}$, $I_{OUT} = 1\text{ mA}$, $V_{EN} = 1.2\text{ V}$, $C_{OUT} = 2.2\text{ }\mu\text{F}$, and $C_{NR} = 0.01\text{ }\mu\text{F}$, unless otherwise noted.

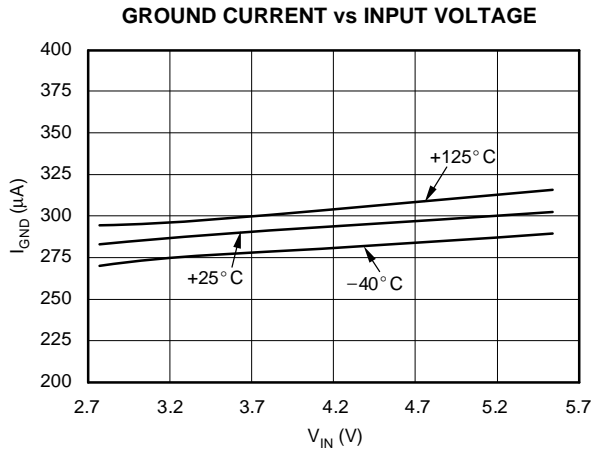

Figure 7.

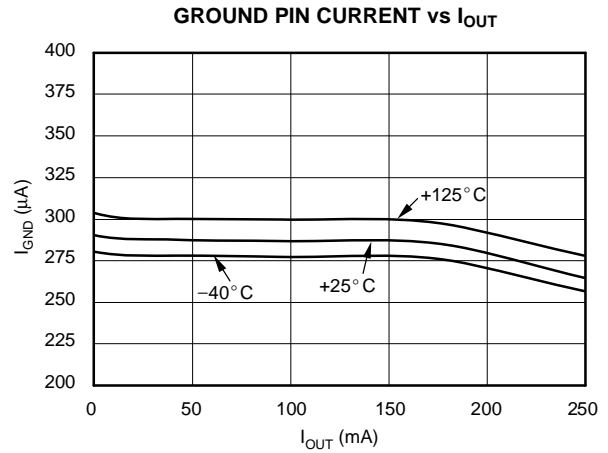

Figure 8.

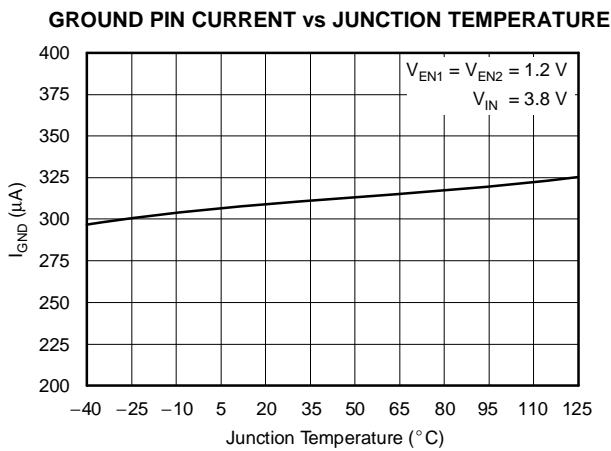

Figure 9.

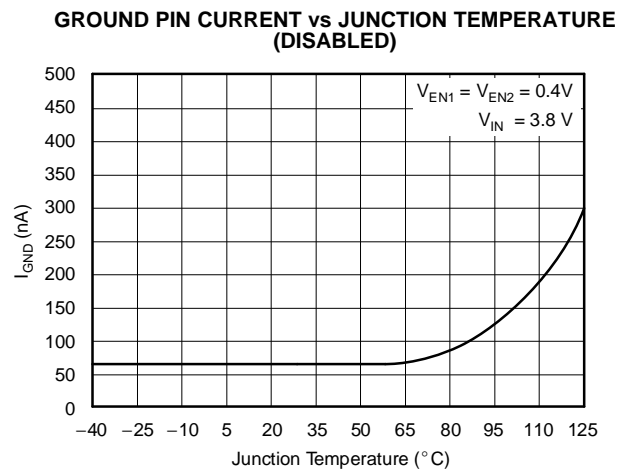

Figure 10.

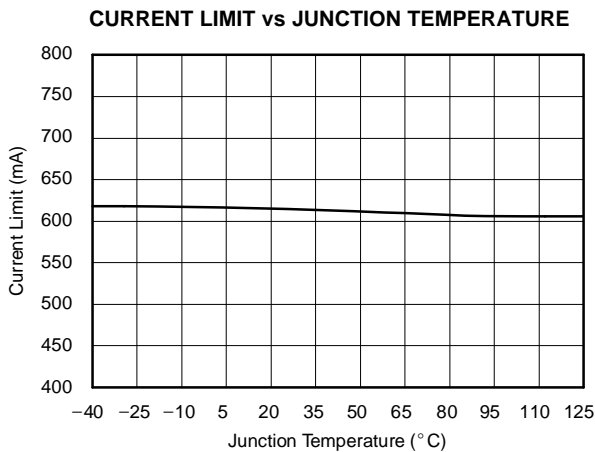

Figure 11.

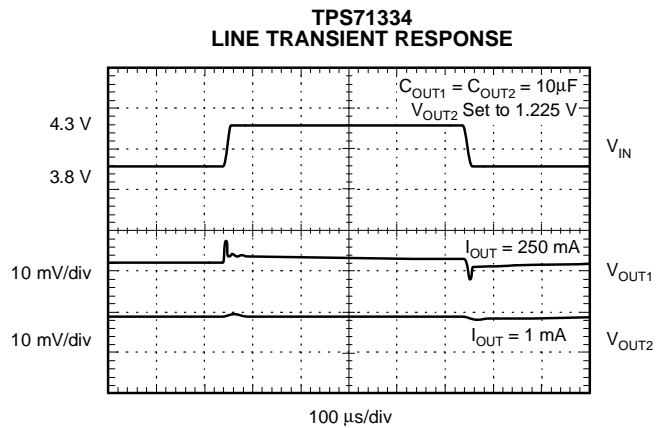

Figure 12.

TYPICAL CHARACTERISTICS (continued)

For all voltage versions at $T_J = 25^\circ\text{C}$, $V_{IN} = V_{OUT(nom)} + 1\text{ V}$, $I_{OUT} = 1\text{ mA}$, $V_{EN} = 1.2\text{ V}$, $C_{OUT} = 2.2\text{ }\mu\text{F}$, and $C_{NR} = 0.01\text{ }\mu\text{F}$, unless otherwise noted.

TPS71334
LOAD TRANSIENT RESPONSE
AND V_{OUT2} CROSSTALK

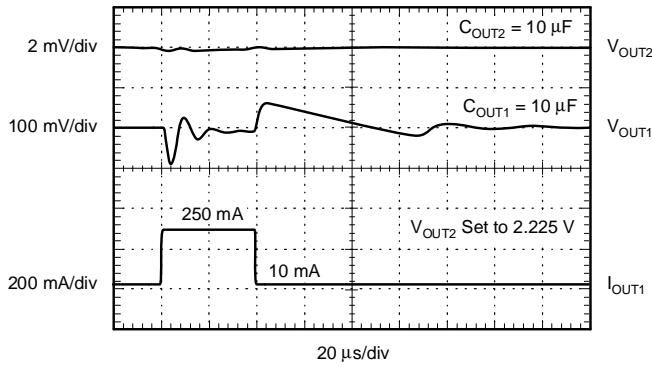

Figure 13.

TPS71334
CHANNEL-TO-CHANNEL ISOLATION vs FREQUENCY

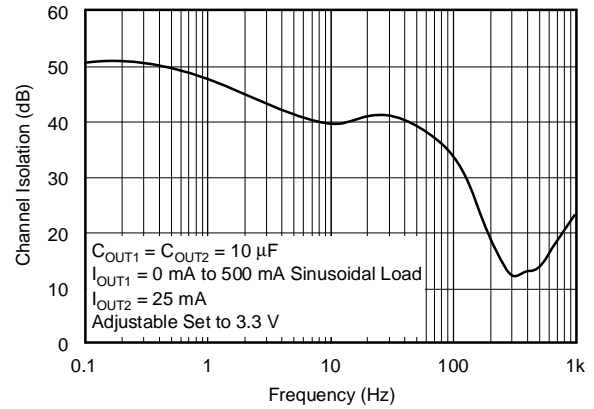

Figure 14.

TPS71334
TURN-ON/OFF RESPONSE
AND V_{OUT2} CROSSTALK

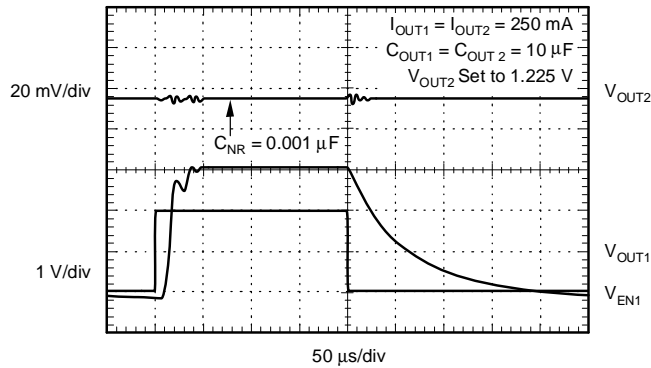

Figure 15.

TPS71334
POWER-UP/POWER-DOWN

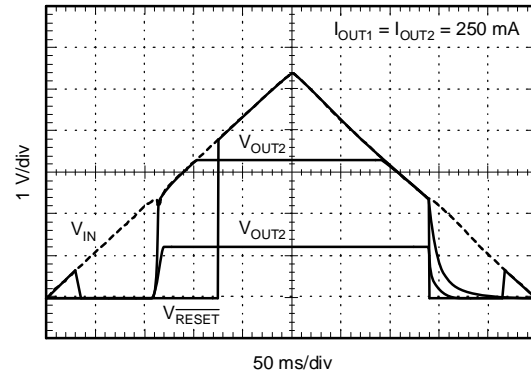

Figure 16.

TOTAL NOISE vs C_{NR}

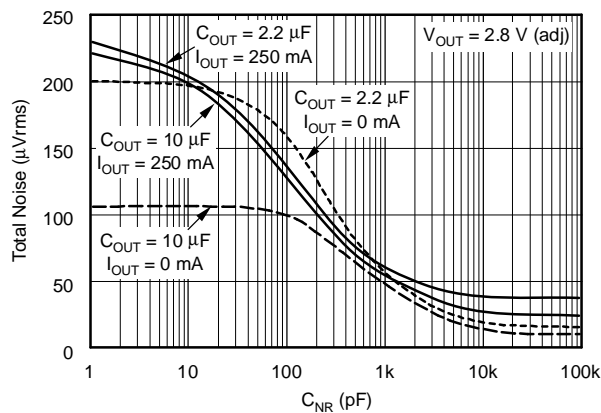

Figure 17.

NOISE SPECTRAL DENSITY
 $C_{OUT} = 2.2\text{ }\mu\text{F}$

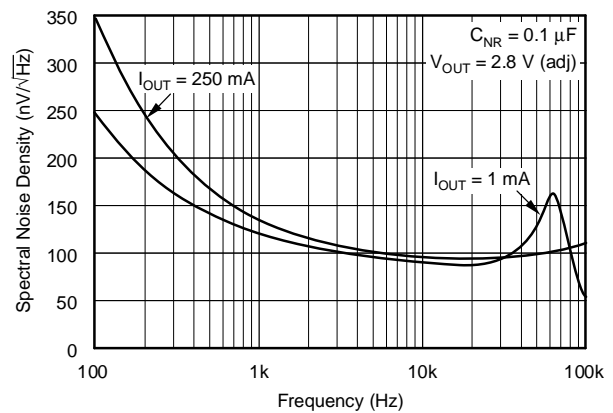

Figure 18.

TYPICAL CHARACTERISTICS (continued)

For all voltage versions at $T_J = 25^\circ\text{C}$, $V_{IN} = V_{OUT(nom)} + 1\text{ V}$, $I_{OUT} = 1\text{ mA}$, $V_{EN} = 1.2\text{ V}$, $C_{OUT} = 2.2\text{ }\mu\text{F}$, and $C_{NR} = 0.01\text{ }\mu\text{F}$, unless otherwise noted.

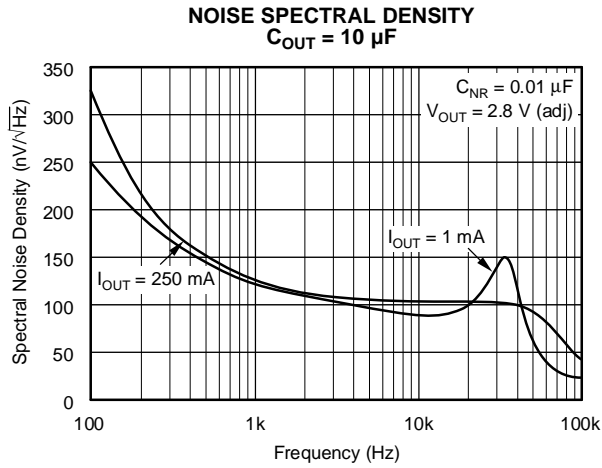

Figure 19.

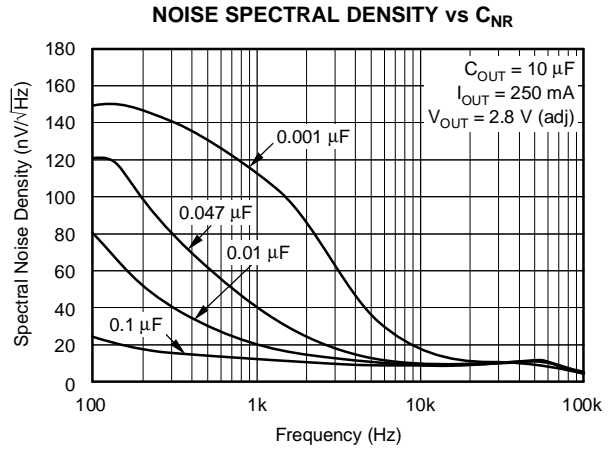

Figure 20.

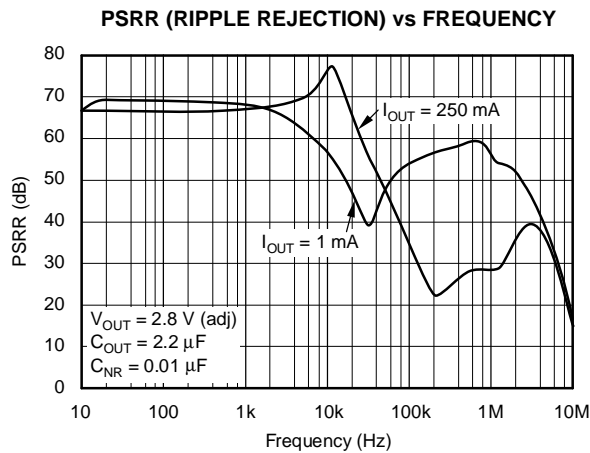

Figure 21.

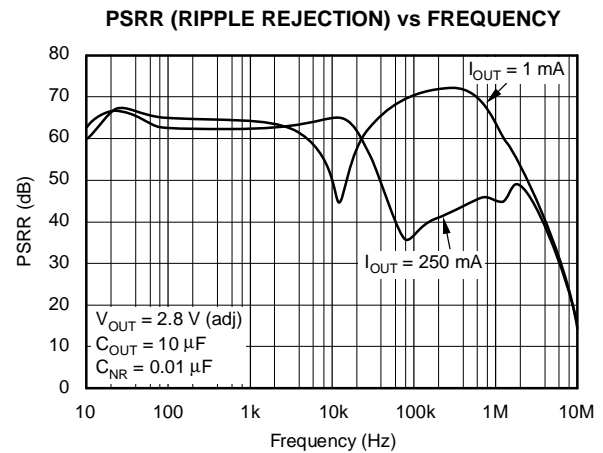

Figure 22.

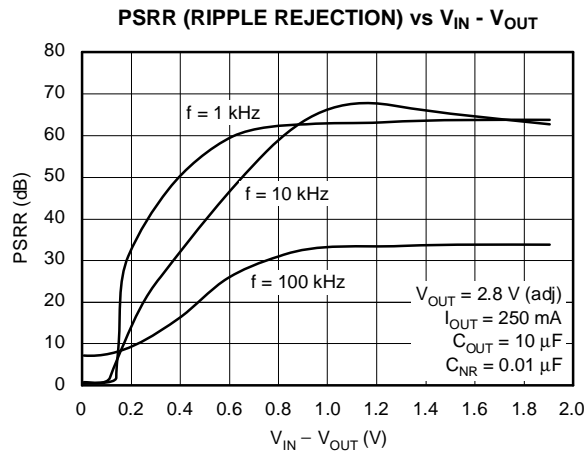

Figure 23.

APPLICATION INFORMATION

The TPS713xx family of dual low-dropout (LDO) regulators has been optimized for use in noise-sensitive battery-operated equipment. The device features extremely low dropout, high PSRR, ultralow output noise, and low quiescent current (190 μA typically per channel). When both outputs are disabled, the supply currents are reduced to less than $2\mu\text{A}$. A typical application circuit with sequencing is shown in Figure 24.

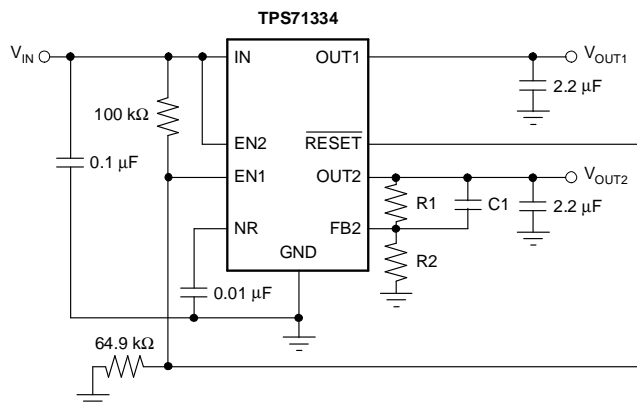

Figure 24. Typical Application Circuit (with output sequencing)

INPUT AND OUTPUT CAPACITOR REQUIREMENTS

A $0.1\ \mu\text{F}$ or larger ceramic input bypass capacitor, connected between IN and GND and located close to the TPS713xx, is required for stability. It improves transient response, noise rejection, and ripple rejection. A higher-value input capacitor may be necessary if large, fast-rise-time load transients are anticipated and the device is located several inches from the power source.

The TPS713xx requires an output capacitor connected between the outputs and GND to stabilize the internal control loops. The minimum recommended output capacitor is $2.2\ \mu\text{F}$. If an output voltage of

1.8 V or less is chosen, the minimum recommended output capacitor is $4.7\ \mu\text{F}$. Any ceramic capacitor that meets the minimum output capacitor requirements is suitable. Capacitors with higher ESR may be used, provided the worst-case ESR is less than $1\ \Omega$.

OUTPUT NOISE

The internal voltage reference is a key source of noise in an LDO regulator. The TPS713xx has an NR pin that is connected to the voltage reference through a $250\ \text{k}\Omega$ internal resistor. The $250\ \text{k}\Omega$ internal resistor, in conjunction with an external ceramic bypass capacitor connected to the NR pin, creates a low-pass filter to reduce the voltage reference noise and, therefore, the noise at the regulator output. To achieve a fast startup, the $250\ \text{k}\Omega$ internal resistor is shorted for $400\ \mu\text{s}$ after the device is enabled.

Because the primary noise source is the internal voltage reference, the output noise will be greater for higher output voltage versions. For the case where no noise reduction capacitor is used, the typical noise (μVrms) over 10 Hz to 100 kHz is 30 times the output voltage. If a $0.01\ \mu\text{F}$ capacitor is used from the NR pin to ground, the noise (μVrms) drops to 11.8 times the output voltage. For example, the TPS71334 with the adjustable output set to 2.8 V exhibits only $33\ \mu\text{Vrms}$ of output voltage noise using a $0.01\ \mu\text{F}$ ceramic bypass capacitor and a $2.2\ \mu\text{F}$ ceramic output capacitor.

STARTUP CHARACTERISTICS

To minimize startup overshoot, the TPS713xx will initially target an output voltage that is approximately 80% of the final value. To avoid a delayed startup time, noise reduction capacitors of $0.01\ \mu\text{F}$ or less are recommended. Larger noise reduction capacitors will cause the output to hold at 80% until the voltage on the noise reduction capacitor exceeds 80% of the bandgap voltage. The typical startup time with a $0.001\ \mu\text{F}$ noise reduction capacitor is $60\ \mu\text{s}$. Once one of the output voltages is present, the startup time of the other output will not be affected by the noise reduction capacitor.

PROGRAMMING THE TPS71202 ADJUSTABLE LDO REGULATOR

The output voltage of the TPS71202 dual adjustable regulator is programmed using an external resistor divider, as shown in Figure 24. The output voltage is calculated using Equation 1:

$$V_{OUT} = V_{REF} \times \left(1 + \frac{R1}{R2}\right) \quad (1)$$

where $V_{REF} = 1.225 \text{ V}$ (the internal reference voltage).

Resistors R2 and R4 should be chosen for approximately a 40 μA divider current. Lower value resistors can be used for improved noise performance, but will consume more power. Higher values should be avoided because leakage current at FB increases the output voltage error. The recommended design procedure is to choose $R2 = 30.1 \text{ k}\Omega$ to set the divider current at 40 μA , and then calculate R1 using Equation 2:

$$R1 = \left(\frac{V_{OUT}}{V_{REF}} - 1\right) \times R2 \quad (2)$$

To improve the stability and noise performance of the adjustable version, a small compensation capacitor can be placed between OUT and FB.

For voltages $\leq 1.8 \text{ V}$, the value of this capacitor should be 100 pF. For voltages $> 1.8 \text{ V}$, the approximate value of this capacitor can be calculated as Equation 3:

$$C1 = \frac{(3 \times 10^5) \times (R1 + R2)}{(R1 \times R2)} (\text{pF}) \quad (3)$$

The suggested value of this capacitor for several resistor ratios is shown in Figure 25. If this capacitor is not used (such as in a unity-gain configuration) or if an output voltage $\leq 1.8 \text{ V}$ is chosen, then the minimum recommended output capacitor is 4.7 μF instead of 2.2 μF .

DROPOUT VOLTAGE

The TPS713xx uses a PMOS pass transistor to achieve extremely low dropout. When $(V_{IN} - V_{OUT})$ is less than the dropout voltage (V_{DO}), the PMOS pass device is in its linear region of operation and the input-to-output resistance is the $R_{DS, ON}$ of the PMOS pass element. Dropout voltages at lower currents can be approximated by calculating the effective $R_{DS, ON}$ of the pass element and multiplying that resistance by the load current. $R_{DS, ON}$ of the pass element can be obtained by dividing the dropout voltage by the rated output current. For the TPS71334, the $R_{DS, ON}$ of the pass element is 84 m Ω . The dropout voltage of the TPS713xx will be less for higher output voltage versions. This is because the PMOS pass element will have lower on-resistance due to increased gate drive.

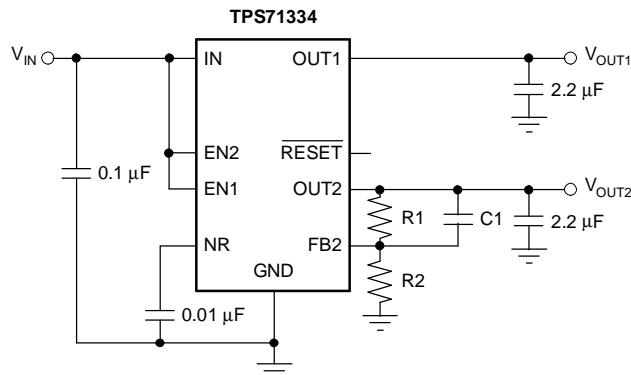

Output Voltage Programming Guide

V_{OUT2}	R1	R2	C1
1.225 V	Short	Open	Open
1.5 V	7.15 k Ω	30.1 k Ω	100 pF
2.5 V	31.6 k Ω	30.1 k Ω	22 pF
3.0 V	43.2 k Ω	30.1 k Ω	15 pF
3.3 V	49.9 k Ω	30.1 k Ω	15 pF
4.75 V	86.6 k Ω	30.1 k Ω	15 pF

Figure 25. TPS71334 Adjustable LDO Regulator Programming

SUPERVISOR DESCRIPTION

The TPS713xx has an on-chip supply voltage supervisor (SVS) that monitors the voltage at OUT2. The $\overline{\text{RESET}}$ output will assert if V_{OUT2} is below the reset threshold (V_{IT}). When OUT2 exceeds the reset threshold plus hysteresis (V_{HYS}), the $\overline{\text{RESET}}$ output will remain low for the specified delay time (t_{D}). When OUT2 is disabled by EN2 or the input voltage is below the under-voltage lockout (UVLO), the reset signal is automatically asserted. The functionality of the reset circuit is shown in Figure 26 and Table 2.

The output accuracy or output divider resistor tolerances have minimal effect on the relative V_{IT} threshold accuracy. The reset threshold V_{IT} will scale accordingly to the actual output voltage. The $\overline{\text{RESET}}$

output will remain unasserted during transients shorter than the reset circuit propagation delay (T_{P}). Even with a 2.2 μF output capacitor, typical load transient conditions will not cause $\overline{\text{RESET}}$ to falsely assert.

The $\overline{\text{RESET}}$ pin requires an external resistor to pull the pin high during the unasserted state. A 10 k Ω to 1 M Ω resistor is suitable for most applications. If the resistance is too low, the pin may not pull low enough to be recognized as a valid logic signal. If the pull-up resistor is too large, the reset pin leakage may cause the device not to pull high enough in the unasserted state. The pull-up voltage for the $\overline{\text{RESET}}$ pin should not exceed $V_{\text{IN}} + 0.3 \text{ V}$; doing so will turn on internal ESD protection devices and may damage the device.

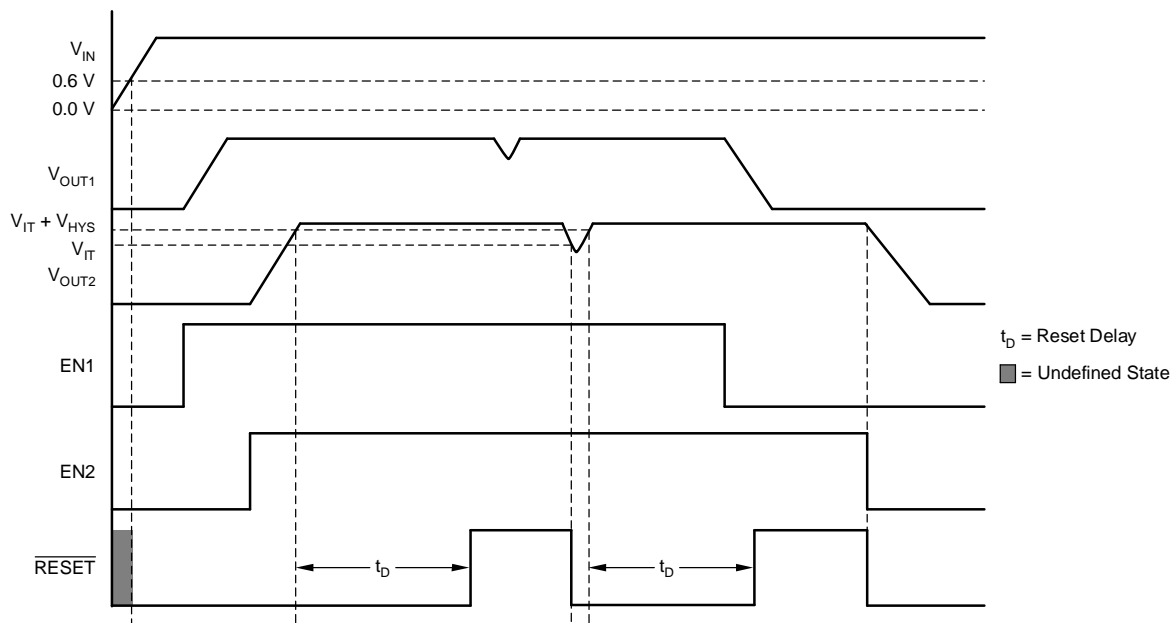

Figure 26. $\overline{\text{RESET}}$ Timing Diagram

Table 2. Reset Pin Truth Table

EN2	UVLO Asserted	V_{OUT2}	$\overline{\text{RESET}}$ Asserted
X ⁽¹⁾	Yes	X	Yes
Low	X	X	Yes
High	No	$V_{\text{OUT2}} > V_{\text{IT}}$	No
High	No	$V_{\text{OUT2}} < V_{\text{IT}}$	Yes

(1) X = don't care.

TRANSIENT RESPONSE

As with any regulator, increasing the size of the output capacitor will reduce over/undershoot magnitude but increase duration of the transient response. In the adjustable version, the addition of a capacitor, C_{FB} , from the output to the feedback pin will also improve stability and transient response. The transient response of the TPS713xx is enhanced with an active pull-down that engages when the output is over-voltaged. The active pull-down decreases the output recovery time when the load is removed. Figure 14 in the Typical Characteristics section shows the output transient response.

SHUTDOWN

Both enable pins are active high and are compatible with standard TTL-CMOS levels. The device is only completely disabled when both EN1 and EN2 are logic low. In this state, the LDO is completely off and the ground pin current drops to approximately 100 nA. With one output disabled, the ground pin current is slightly greater than half the nominal value. When shutdown capability is not required, the enable pins should be connected to the input supply.

INTERNAL CURRENT LIMIT

The TPS713xx internal current limit helps protect the regulator during fault conditions. During current limit, the output will source a fixed amount of current that is largely independent of the output voltage.

The TPS713xx PMOS-pass transistors have a built-in back diode that conducts reverse current when the input voltage drops below the output voltage (that is, during power-down). Current is conducted from the output to the input and is not internally limited. If extended reverse voltage operation is anticipated, external limiting may be appropriate.

THERMAL PROTECTION

Thermal protection disables both outputs when the junction temperature of either channel rises to approximately +160°C, allowing the device to cool. When the junction temperature cools to approximately +140°C, the output circuitry is again enabled.

Depending on power dissipation, thermal resistance, and ambient temperature, the thermal protection circuit may cycle on and off. This limits the dissipation of the regulator, protecting it from damage due to overheating.

Any tendency to activate the thermal protection circuit indicates excessive power dissipation or an inadequate heatsink. For reliable operation, junction temperature should be limited to +125°C maximum. To estimate the margin of safety in a complete design (including heatsink), increase the ambient temperature until the thermal protection is triggered; use worst-case loads and signal conditions. For good reliability, thermal protection should trigger at least +35°C above the maximum expected ambient condition of your application. This produces a worst-case junction temperature of +125°C at the highest expected ambient temperature and worst-case load.

The internal protection circuitry of the TPS713xx was designed to protect against overload conditions. It was not intended to replace proper heatsinking. Continuously running the TPS713xx into thermal shutdown will degrade device reliability.

POWER DISSIPATION

The ability to remove heat from the die is different for each package type, presenting different considerations in the PCB layout. The PCB area around the device that is free of other components moves the heat from the device to the ambient air. Performance data for a JEDEC high-K board is shown in the Dissipation Ratings table. Using heavier copper will increase the effectiveness in removing heat from the device. The addition of plated through-holes to heat-dissipating layers will also improve the heat-sink effectiveness.

Power dissipation depends on input voltage and load conditions. Power dissipation is equal to the product of the output current times the voltage drop across the output pass element (V_{IN} to V_{OUT}):

$$P_D = (V_{IN} - V_{OUT}) \times I_{OUT} \quad (4)$$

Power dissipation can be minimized by using the lowest possible input voltage necessary to assure the required output voltage.

PACKAGING INFORMATION

Orderable Device	Status (1)	Package Type	Package Drawing	Pins	Package Qty	Eco Plan (2)	Lead/Ball Finish (6)	MSL Peak Temp (3)	Op Temp (°C)	Device Marking (4/5)	Samples
TPS71319DRCR	ACTIVE	VSON	DRC	10	3000	Green (RoHS & no Sb/Br)	CU NIPDAU	Level-2-260C-1 YEAR	-40 to 125	ARP	Samples
TPS71319DRCT	ACTIVE	VSON	DRC	10	250	Green (RoHS & no Sb/Br)	CU NIPDAU	Level-2-260C-1 YEAR	-40 to 125	ARP	Samples
TPS71334DRCR	ACTIVE	VSON	DRC	10	3000	Green (RoHS & no Sb/Br)	CU NIPDAU	Level-2-260C-1 YEAR	-40 to 125	ARO	Samples
TPS71334DRCT	ACTIVE	VSON	DRC	10	250	Green (RoHS & no Sb/Br)	CU NIPDAU	Level-2-260C-1 YEAR	-40 to 125	ARO	Samples

(1) The marketing status values are defined as follows:

ACTIVE: Product device recommended for new designs.

LIFEBUY: TI has announced that the device will be discontinued, and a lifetime-buy period is in effect.

NRND: Not recommended for new designs. Device is in production to support existing customers, but TI does not recommend using this part in a new design.

PREVIEW: Device has been announced but is not in production. Samples may or may not be available.

OBSOLETE: TI has discontinued the production of the device.

(2) **RoHS:** TI defines "RoHS" to mean semiconductor products that are compliant with the current EU RoHS requirements for all 10 RoHS substances, including the requirement that RoHS substance do not exceed 0.1% by weight in homogeneous materials. Where designed to be soldered at high temperatures, "RoHS" products are suitable for use in specified lead-free processes. TI may reference these types of products as "Pb-Free".

RoHS Exempt: TI defines "RoHS Exempt" to mean products that contain lead but are compliant with EU RoHS pursuant to a specific EU RoHS exemption.

Green: TI defines "Green" to mean the content of Chlorine (Cl) and Bromine (Br) based flame retardants meet JS709B low halogen requirements of <=1000ppm threshold. Antimony trioxide based flame retardants must also meet the <=1000ppm threshold requirement.

(3) MSL, Peak Temp. - The Moisture Sensitivity Level rating according to the JEDEC industry standard classifications, and peak solder temperature.

(4) There may be additional marking, which relates to the logo, the lot trace code information, or the environmental category on the device.

(5) Multiple Device Markings will be inside parentheses. Only one Device Marking contained in parentheses and separated by a "-" will appear on a device. If a line is indented then it is a continuation of the previous line and the two combined represent the entire Device Marking for that device.

(6) Lead/Ball Finish - Orderable Devices may have multiple material finish options. Finish options are separated by a vertical ruled line. Lead/Ball Finish values may wrap to two lines if the finish value exceeds the maximum column width.

Important Information and Disclaimer:The information provided on this page represents TI's knowledge and belief as of the date that it is provided. TI bases its knowledge and belief on information provided by third parties, and makes no representation or warranty as to the accuracy of such information. Efforts are underway to better integrate information from third parties. TI has taken and

continues to take reasonable steps to provide representative and accurate information but may not have conducted destructive testing or chemical analysis on incoming materials and chemicals. TI and TI suppliers consider certain information to be proprietary, and thus CAS numbers and other limited information may not be available for release.

In no event shall TI's liability arising out of such information exceed the total purchase price of the TI part(s) at issue in this document sold by TI to Customer on an annual basis.

TAPE AND REEL INFORMATION



QUADRANT ASSIGNMENTS FOR PIN 1 ORIENTATION IN TAPE



*All dimensions are nominal

Device	Package Type	Package Drawing	Pins	SPQ	Reel Diameter (mm)	Reel Width W1 (mm)	A0 (mm)	B0 (mm)	K0 (mm)	P1 (mm)	W (mm)	Pin1 Quadrant
TPS71319DRCR	VSON	DRC	10	3000	330.0	12.4	3.3	3.3	1.1	8.0	12.0	Q2
TPS71319DRCT	VSON	DRC	10	250	180.0	12.4	3.3	3.3	1.1	8.0	12.0	Q2
TPS71334DRCR	VSON	DRC	10	3000	330.0	12.4	3.3	3.3	1.1	8.0	12.0	Q2
TPS71334DRCT	VSON	DRC	10	250	180.0	12.4	3.3	3.3	1.1	8.0	12.0	Q2

TAPE AND REEL BOX DIMENSIONS

*All dimensions are nominal

Device	Package Type	Package Drawing	Pins	SPQ	Length (mm)	Width (mm)	Height (mm)
TPS71319DRCR	VSON	DRC	10	3000	367.0	367.0	35.0
TPS71319DRCT	VSON	DRC	10	250	210.0	185.0	35.0
TPS71334DRCR	VSON	DRC	10	3000	367.0	367.0	35.0
TPS71334DRCT	VSON	DRC	10	250	210.0	185.0	35.0

GENERIC PACKAGE VIEW

DRC 10

VSON - 1 mm max height

PLASTIC SMALL OUTLINE - NO LEAD

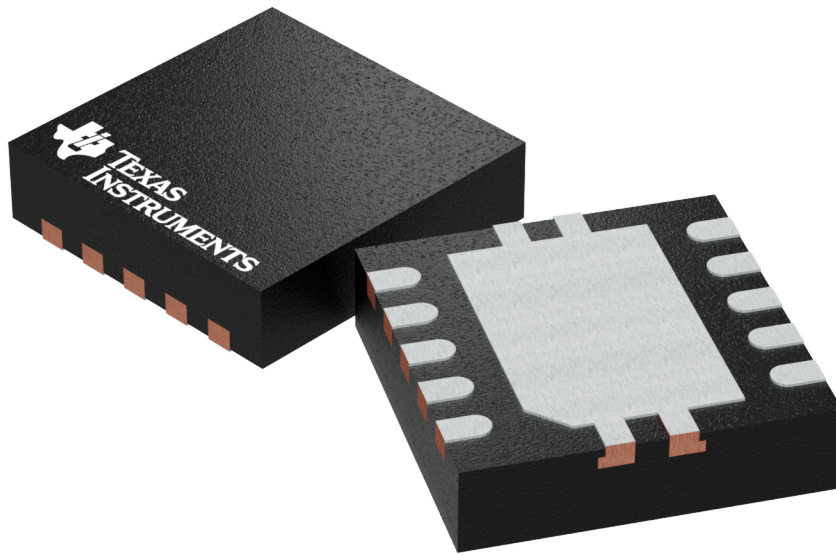

Images above are just a representation of the package family, actual package may vary.
Refer to the product data sheet for package details.

4204102-3/M

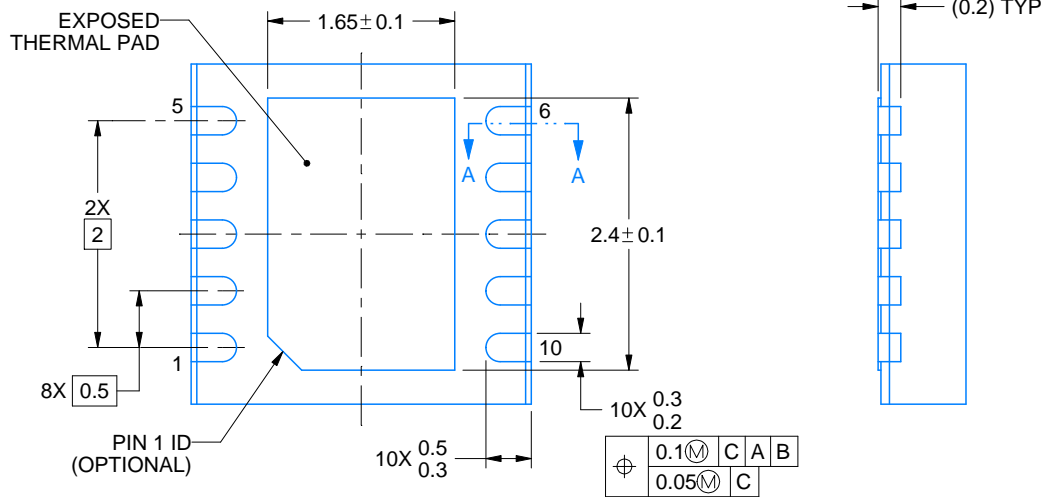
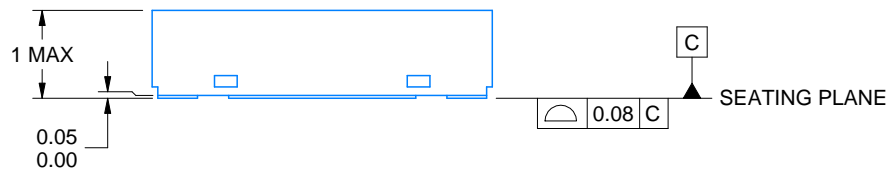
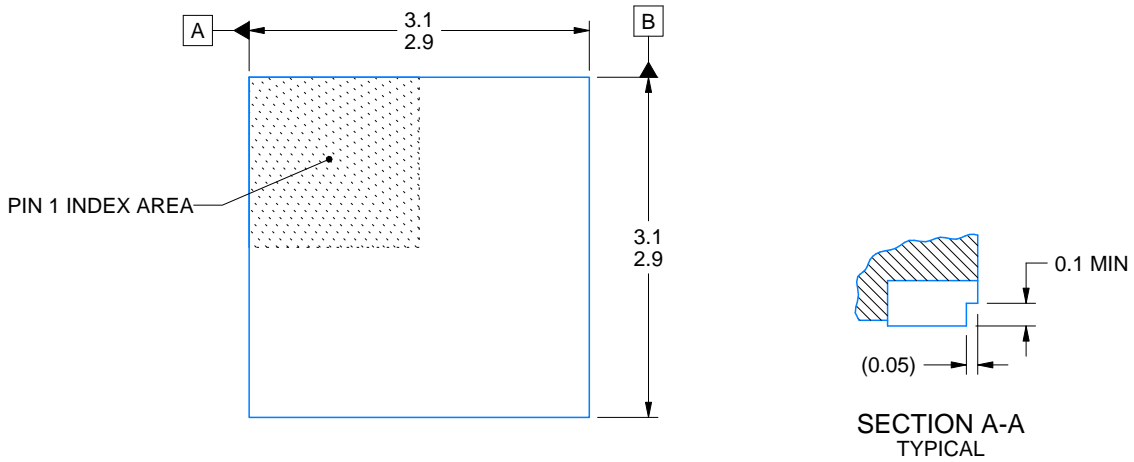

4222059/B 02/2018

NOTES:

1. All linear dimensions are in millimeters. Any dimensions in parenthesis are for reference only. Dimensioning and tolerancing per ASME Y14.5M.
2. This drawing is subject to change without notice.
3. The package thermal pad must be soldered to the printed circuit board for thermal and mechanical performance.

EXAMPLE BOARD LAYOUT

DRC0010K

VSON - 1 mm max height

PLASTIC SMALL OUTLINE - NO LEAD

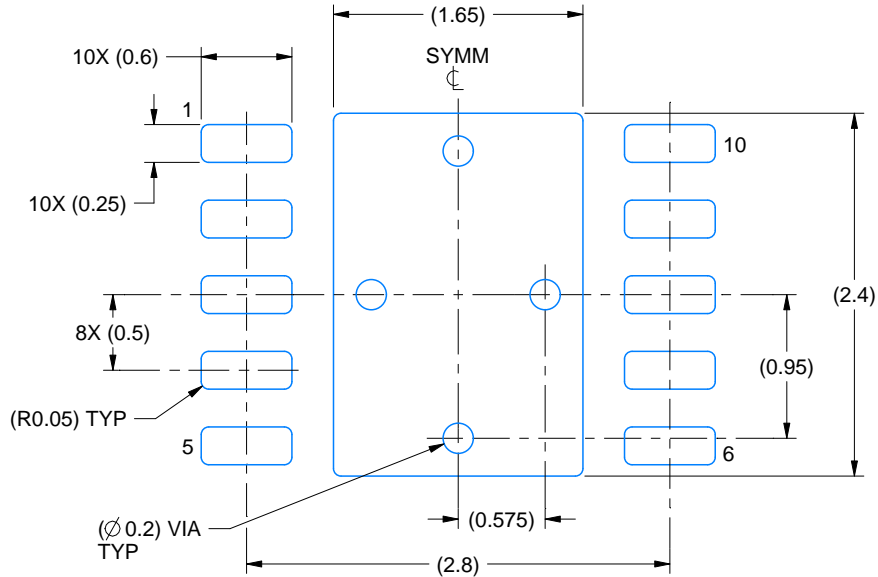

LAND PATTERN EXAMPLE
EXPOSED METAL SHOWN
SCALE:20X

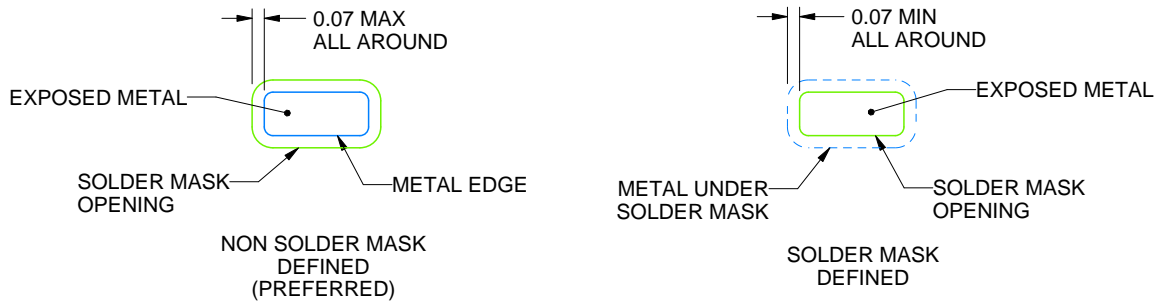

SOLDER MASK DETAILS

4222059/B 02/2018

NOTES: (continued)

4. This package is designed to be soldered to a thermal pad on the board. For more information, see Texas Instruments literature number SLUA271 (www.ti.com/lit/slua271).

EXAMPLE STENCIL DESIGN

DRC0010K

VSON - 1 mm max height

PLASTIC SMALL OUTLINE - NO LEAD

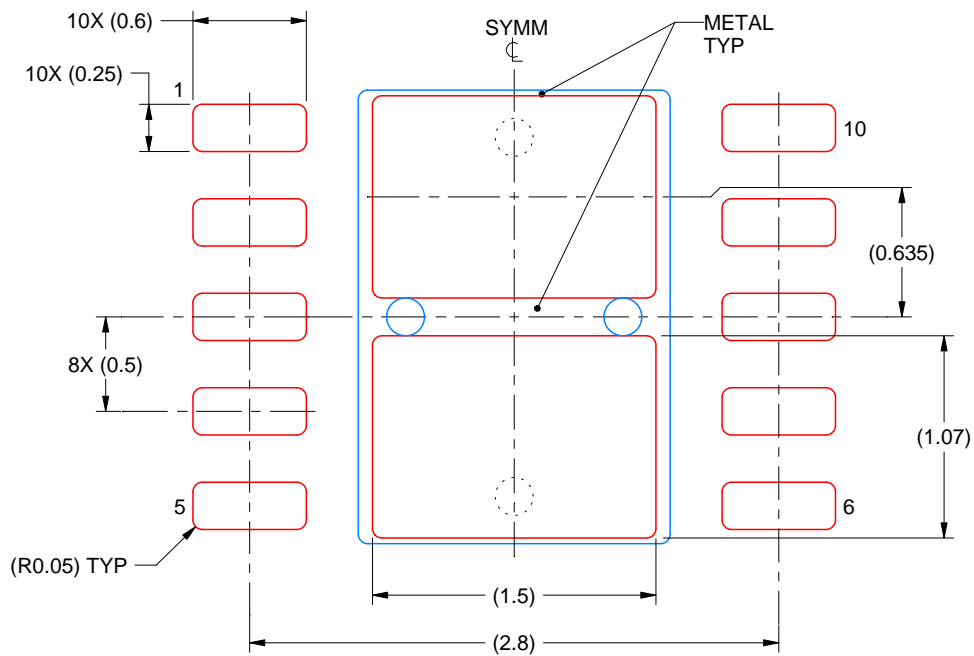

SOLDER PASTE EXAMPLE
BASED ON 0.125 mm THICK STENCIL

EXPOSED PAD
81% PRINTED SOLDER COVERAGE BY AREA
SCALE:25X

4222059/B 02/2018

NOTES: (continued)

5. Laser cutting apertures with trapezoidal walls and rounded corners may offer better paste release. IPC-7525 may have alternate design recommendations.

IMPORTANT NOTICE

Texas Instruments Incorporated (TI) reserves the right to make corrections, enhancements, improvements and other changes to its semiconductor products and services per JESD46, latest issue, and to discontinue any product or service per JESD48, latest issue. Buyers should obtain the latest relevant information before placing orders and should verify that such information is current and complete.

TI's published terms of sale for semiconductor products (<http://www.ti.com/sc/docs/stdterms.htm>) apply to the sale of packaged integrated circuit products that TI has qualified and released to market. Additional terms may apply to the use or sale of other types of TI products and services.

Reproduction of significant portions of TI information in TI data sheets is permissible only if reproduction is without alteration and is accompanied by all associated warranties, conditions, limitations, and notices. TI is not responsible or liable for such reproduced documentation. Information of third parties may be subject to additional restrictions. Resale of TI products or services with statements different from or beyond the parameters stated by TI for that product or service voids all express and any implied warranties for the associated TI product or service and is an unfair and deceptive business practice. TI is not responsible or liable for any such statements.

Buyers and others who are developing systems that incorporate TI products (collectively, "Designers") understand and agree that Designers remain responsible for using their independent analysis, evaluation and judgment in designing their applications and that Designers have full and exclusive responsibility to assure the safety of Designers' applications and compliance of their applications (and of all TI products used in or for Designers' applications) with all applicable regulations, laws and other applicable requirements. Designer represents that, with respect to their applications, Designer has all the necessary expertise to create and implement safeguards that (1) anticipate dangerous consequences of failures, (2) monitor failures and their consequences, and (3) lessen the likelihood of failures that might cause harm and take appropriate actions. Designer agrees that prior to using or distributing any applications that include TI products, Designer will thoroughly test such applications and the functionality of such TI products as used in such applications.

TI's provision of technical, application or other design advice, quality characterization, reliability data or other services or information, including, but not limited to, reference designs and materials relating to evaluation modules, (collectively, "TI Resources") are intended to assist designers who are developing applications that incorporate TI products; by downloading, accessing or using TI Resources in any way, Designer (individually or, if Designer is acting on behalf of a company, Designer's company) agrees to use any particular TI Resource solely for this purpose and subject to the terms of this Notice.

TI's provision of TI Resources does not expand or otherwise alter TI's applicable published warranties or warranty disclaimers for TI products, and no additional obligations or liabilities arise from TI providing such TI Resources. TI reserves the right to make corrections, enhancements, improvements and other changes to its TI Resources. TI has not conducted any testing other than that specifically described in the published documentation for a particular TI Resource.

Designer is authorized to use, copy and modify any individual TI Resource only in connection with the development of applications that include the TI product(s) identified in such TI Resource. NO OTHER LICENSE, EXPRESS OR IMPLIED, BY ESTOPPEL OR OTHERWISE TO ANY OTHER TI INTELLECTUAL PROPERTY RIGHT, AND NO LICENSE TO ANY TECHNOLOGY OR INTELLECTUAL PROPERTY RIGHT OF TI OR ANY THIRD PARTY IS GRANTED HEREIN, including but not limited to any patent right, copyright, mask work right, or other intellectual property right relating to any combination, machine, or process in which TI products or services are used. Information regarding or referencing third-party products or services does not constitute a license to use such products or services, or a warranty or endorsement thereof. Use of TI Resources may require a license from a third party under the patents or other intellectual property of the third party, or a license from TI under the patents or other intellectual property of TI.

TI RESOURCES ARE PROVIDED "AS IS" AND WITH ALL FAULTS. TI DISCLAIMS ALL OTHER WARRANTIES OR REPRESENTATIONS, EXPRESS OR IMPLIED, REGARDING RESOURCES OR USE THEREOF, INCLUDING BUT NOT LIMITED TO ACCURACY OR COMPLETENESS, TITLE, ANY EPIDEMIC FAILURE WARRANTY AND ANY IMPLIED WARRANTIES OF MERCHANTABILITY, FITNESS FOR A PARTICULAR PURPOSE, AND NON-INFRINGEMENT OF ANY THIRD PARTY INTELLECTUAL PROPERTY RIGHTS. TI SHALL NOT BE LIABLE FOR AND SHALL NOT DEFEND OR INDEMNIFY DESIGNER AGAINST ANY CLAIM, INCLUDING BUT NOT LIMITED TO ANY INFRINGEMENT CLAIM THAT RELATES TO OR IS BASED ON ANY COMBINATION OF PRODUCTS EVEN IF DESCRIBED IN TI RESOURCES OR OTHERWISE. IN NO EVENT SHALL TI BE LIABLE FOR ANY ACTUAL, DIRECT, SPECIAL, COLLATERAL, INDIRECT, PUNITIVE, INCIDENTAL, CONSEQUENTIAL OR EXEMPLARY DAMAGES IN CONNECTION WITH OR ARISING OUT OF TI RESOURCES OR USE THEREOF, AND REGARDLESS OF WHETHER TI HAS BEEN ADVISED OF THE POSSIBILITY OF SUCH DAMAGES.

Unless TI has explicitly designated an individual product as meeting the requirements of a particular industry standard (e.g., ISO/TS 16949 and ISO 26262), TI is not responsible for any failure to meet such industry standard requirements.

Where TI specifically promotes products as facilitating functional safety or as compliant with industry functional safety standards, such products are intended to help enable customers to design and create their own applications that meet applicable functional safety standards and requirements. Using products in an application does not by itself establish any safety features in the application. Designers must ensure compliance with safety-related requirements and standards applicable to their applications. Designer may not use any TI products in life-critical medical equipment unless authorized officers of the parties have executed a special contract specifically governing such use. Life-critical medical equipment is medical equipment where failure of such equipment would cause serious bodily injury or death (e.g., life support, pacemakers, defibrillators, heart pumps, neurostimulators, and implantables). Such equipment includes, without limitation, all medical devices identified by the U.S. Food and Drug Administration as Class III devices and equivalent classifications outside the U.S.

TI may expressly designate certain products as completing a particular qualification (e.g., Q100, Military Grade, or Enhanced Product). Designers agree that it has the necessary expertise to select the product with the appropriate qualification designation for their applications and that proper product selection is at Designers' own risk. Designers are solely responsible for compliance with all legal and regulatory requirements in connection with such selection.

Designer will fully indemnify TI and its representatives against any damages, costs, losses, and/or liabilities arising out of Designer's non-compliance with the terms and provisions of this Notice.

Looking for pricing, stock, or lifecycle information?

Click below to explore more details on WIN SOURCE:

 [View TPS71319DRCTG4 on WIN SOURCE](#)

 [Texas Instruments](#) Information

Optimize Your Supply Chain with WIN SOURCE Solutions

-  Global Sourcing Solution
-  Obsolete Management
-  Cost Control Management
-  Shortage Management
-  Alternative Solution
-  Excess Inventory Management