



50 Watt Zener Diodes

Qualified per MIL-PRF-19500/114

Qualified Levels:
JAN, JANTX, and
JANTXV

DESCRIPTION

This series of high power 50W Zener diodes, JEDEC registered 1N2804B through 1N2846B and 1N4557B through 1N4564B, provide voltage regulation in values from 3.9 V to 200 V broad range of voltages. They may be operated up to 50 W with adequate mounting and heat sinking due to their low thermal resistance. These Zeners are also available in reverse polarity. On select part numbers, these Zeners are also available in JAN, JANTX, and JANTXV military qualifications.

Important: For the latest information, visit our website <http://www.microsemi.com>.

FEATURES

- JEDEC registered 1N2804 through 1N2846B and 1N4557 through 1N4564B numbers.
- Internal solder bond construction.
- Hermetically sealed (welded).
- Zener voltage 3.9 V to 200 V.
- JAN, JANTX, and JANTXV qualifications also available per MIL-PRF-19500/114 on most family members (see [Electrical Characteristics](#) table).
(See [Part Nomenclature](#) for all available options).
- Standard polarity is anode to case. Reverse polarity is available.
- RoHS compliant versions available (commercial grade only).

APPLICATIONS / BENEFITS

- Regulates voltage over a broad range of operating current and temperature.
- Voltage tolerances of 10%, 5%, 2%, and 1% are available.
- Non-sensitive to ESD per MIL-STD-750 method 1020.
- Inherently radiation hard as described in Microsemi [MicroNote 050](#).

MAXIMUM RATINGS

Parameters/Test Conditions	Symbol	Value	Unit
Junction Temperature	T_J	-65 to +175	°C
Storage Temperature	T_{STG}	-65 to +200	°C
Thermal Resistance Junction to Case @ $T_C = 30\text{ °C} \pm 3\text{ °C}$	$R_{\theta JC}$	2.0	°C/W
Average Rated Power Dissipation @ $T_C \geq 75\text{ °C}$	$P_{M(AV)}$	50	W
Power Derating @ $T_C \geq +75\text{ °C}$		0.5	W/°C
Forward Voltage @ $I_F = 10A$	V_F	1.5	V
Solder Temperature @ 10 s max	T_{SP}	260	°C



**TO-204AD (TO-3)
Package**

MSC – Lawrence

6 Lake Street,
Lawrence, MA 01841
Tel: 1-800-446-1158 or
(978) 620-2600
Fax: (978) 689-0803

MSC – Ireland

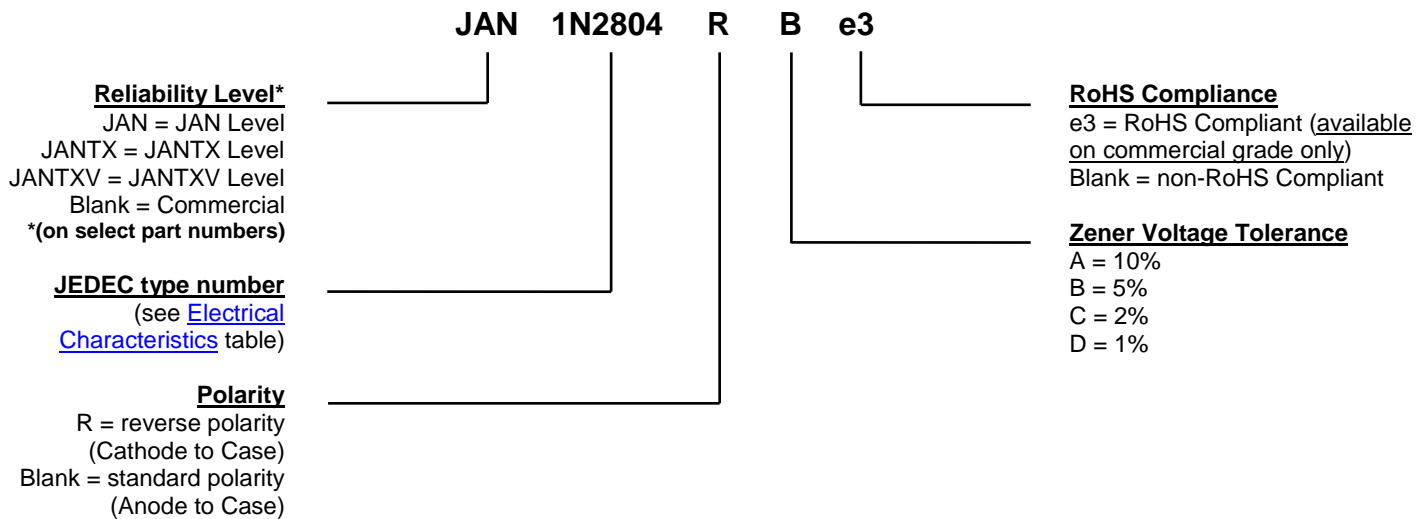
Gort Road Business Park,
Ennis, Co. Clare, Ireland
Tel: +353 (0) 65 6840044
Fax: +353 (0) 65 6822298

Website:

www.microsemi.com

MECHANICAL and PACKAGING

- CASE: Industry standard TO-3 (TO-204AD), hermetically sealed, 0.052 inch diameter pins.
- FINISH: Solder dipped tin-lead over nickel plated alloy 52. Solderable per MIL-STD-750 method 2026. RoHS compliant matte-tin plating is also available on commercial grade only.
- POLARITY: Standard polarity units are connected anode to case. Reverse polarity (cathode to case) is indicated by suffix R. In either example, both pins are common with one another as anode or cathode (see [Figure 2](#)).
- WEIGHT: Approximately 15 grams.
- MOUNTING HARDWARE: Consult factory for optional insulator and sheet metal screws.
- See [Package Dimensions](#) on last page.

PART NOMENCLATURE

SYMBOLS & DEFINITIONS

Symbol	Definition
I_R	Reverse Current: The maximum reverse (leakage) current that will flow at the specified voltage and temperature.
I_Z, I_{ZT}, I_{ZK}	Regulator Current: The dc regulator current (I_Z), at a specified test point (I_{ZT}), near breakdown knee (I_{ZK}).
I_{ZM}	Maximum Regulator (Zener) Current: The maximum rated dc current for the specified power rating.
V_R	Reverse Voltage: The reverse voltage dc value, no alternating component.
V_F	Maximum Forward Voltage: The maximum forward voltage the device will exhibit at a specified current.
V_Z	Zener Voltage: The Zener voltage the device will exhibit at a specified current (I_Z) in its breakdown region.
Z_{ZT} or Z_{ZK}	Dynamic Impedance: The small signal impedance of the diode when biased to operate in its breakdown region at a specified rms current modulation (typically 10% of I_{ZT} or I_{ZK}) and superimposed on I_{ZT} or I_{ZK} respectively.

* ELECTRICAL CHARACTERISTICS @ $T_C = 30^\circ\text{C} \pm 3^\circ\text{C}$ unless otherwise noted

JEDEC TYPE NUMBER (Note 1)	NOMINAL ZENER VOLTAGE $V_Z @ I_{ZT}$	ZENER TEST CURRENT (I_{ZT})	MAXIMUM DYNAMIC IMPEDANCE (NOTE 2)		MAX DC ZENER CURRENT (I_{ZM}) @ 75°C Stud Temp. (Note 3)	TYPICAL TEMPERATURE COEFFICIENT α_{VZ}	MAX** REVERSE CURRENT $I_R @ V_R$	
			$Z_{ZT} @ I_{ZT}$	$Z_{ZK} @ 1 \text{ mA}$ (I_{ZK})			μA	Volts
			Ohms	Ohms				
†1N4557B	3.9	3200	0.16	400	10,000	-0.050	150	0.5
†1N4558B	4.3	2900	0.16	500	9,000	-0.035	150	0.5
†1N4559B	4.7	2650	0.12	600	8,000	± 0.015	100	1.0
†1N4560B	5.1	2450	0.12	650	7,500	0.035	20	1.0
†1N4561B	5.6	2250	0.12	900	7,000	0.050	20	1.0
†1N4562B	6.2	2000	0.14	1000	6,500	0.055	20	2.0
1N4563B	6.8	1850	0.16	200	6,650	0.053	10	2.0
1N4564B	7.5	1650	0.24	100	6,050	0.057	10	3.0
†1N2804B	6.8	1850	0.2	70	7,000	0.057	150	4.5
†1N2805B	7.5	1700	0.3	70	6,360	0.067	100	5.0
†1N2806B	8.2	1500	0.4	70	5,800	0.070	50	5.4
†1N2807B	9.1	1370	0.5	70	5,240	0.075	25	6.1
†1N2808B	10	1200	0.6	80	4,760	0.081	25	6.7
†1N2809B	11	1100	0.8	80	4,330	0.085	10	8.4
†1N2810B	12	1000	1.0	80	3,970	0.079	10	9.1
†1N2811B	13	960	1.1	80	3,750	0.080	10	9.9
1N2812B	14	890	1.2	80	3,400	0.070	10	10.6
†1N2813B	15	830	1.4	80	3,170	0.082	10	11.4
†1N2814B	16	780	1.6	80	2,970	0.083	10	12.2
1N2815B	17	740	1.8	80	2,750	0.075	10	13.0
†1N2816B	18	700	2.0	80	2,640	0.085	10	13.7
1N2817B	19	660	2.2	80	2,450	0.075	10	14.4
†1N2818B	20	630	2.4	80	2,380	0.086	10	15.2
†1N2819B	22	570	2.5	80	2,160	0.087	10	16.7
†1N2820B	24	520	2.6	80	1,980	0.088	10	18.2
1N2821B	25	500	2.7	80	1,850	0.080	10	19.0
†1N2822B	27	460	2.8	90	1,760	0.090	10	20.6
†1N2823B	30	420	3.0	90	1,590	0.091	10	22.8
†1N2824B	33	380	3.2	90	1,440	0.092	10	25.1
†1N2825B	36	350	3.5	90	1,320	0.093	10	27.4
†1N2826B	39	320	4.0	90	1,220	0.094	10	29.7
†1N2827B	43	290	4.5	90	1,000	0.095	10	32.7
1N2828B	45	280	4.5	100	1,030	0.090	10	34.2
†1N2829B	47	270	5.0	100	1,020	0.095	10	35.8
1N2830B	50	250	5.0	100	935	0.090	10	38.0
†1N2831B	51	245	5.2	100	930	0.096	10	38.8
†1N2832B	56	220	6	110	850	0.096	10	42.6
†1N2833B	62	200	7	120	770	0.097	10	47.1
†1N2834B	68	180	8	140	700	0.097	10	51.7
†1N2835B	75	170	9	150	640	0.098	10	56.0
†1N2836B	82	150	11	160	580	0.098	10	62.2
†1N2837B	91	140	15	180	530	0.099	10	69.2
†1N2838B	100	120	20	200	480	0.100	10	76.0
1N2839B	105	120	25	210	430	0.090	10	79.8
†1N2840B	110	110	30	220	430	0.100	10	83.6
†1N2841B	120	100	40	240	400	0.100	10	91.2
†1N2842B	130	95	50	275	370	0.100	10	98.8
†1N2843B	150	85	75	400	320	0.100	10	114.0
†1N2844B	160	80	80	450	300	0.100	10	121.6
†1N2845B	180	68	90	525	260	0.100	10	136.8
†1N2846B	200	65	100	600	240	0.100	10	152.0

* JEDEC Registered Data. **Not JEDEC Data. † Have JAN, JANTX and JANTXV Qualifications to MIL-PRF-19500/114

See notes on following page.

NOTES:

1. The JEDEC type numbers shown (B suffix) have a +/- 5 % tolerance on nominal Zener voltage.
2. Zener voltage (V_Z) is measured with junction in thermal equilibrium with 30 °C base temperature. The test currents (I_{ZT}) have been selected so that at nominal voltages the dissipation is a constant 12.5 watts. This results in a nominal junction temperature rise of 18.75 °C.
3. The Zener impedance is derived from the 60 cycle ac voltage, which results when an ac current having an rms value equal to 10% of the dc Zener current (I_{ZT} or I_{ZK}) is superimposed on I_{ZT} or I_{ZK} . Zener impedance is measured at 2 points to ensure a sharp knee on the breakdown curve and to eliminate unstable units. A curve showing the variation of Zener impedance vs. Zener current for six representative types is shown in [Figure 3](#). Also see [MicroNote 202](#) for further information.
4. The values of I_{ZM} are calculated for a +/- 5 % tolerance on nominal Zener voltage. Allowance has been made for the rise in Zener voltage above V_{ZT} that results from Zener impedance and the increase in junction temperature as power dissipation approaches 50 watts. In the case of individual diodes, I_{ZM} is that value of current that results in a dissipation of 50 watts.

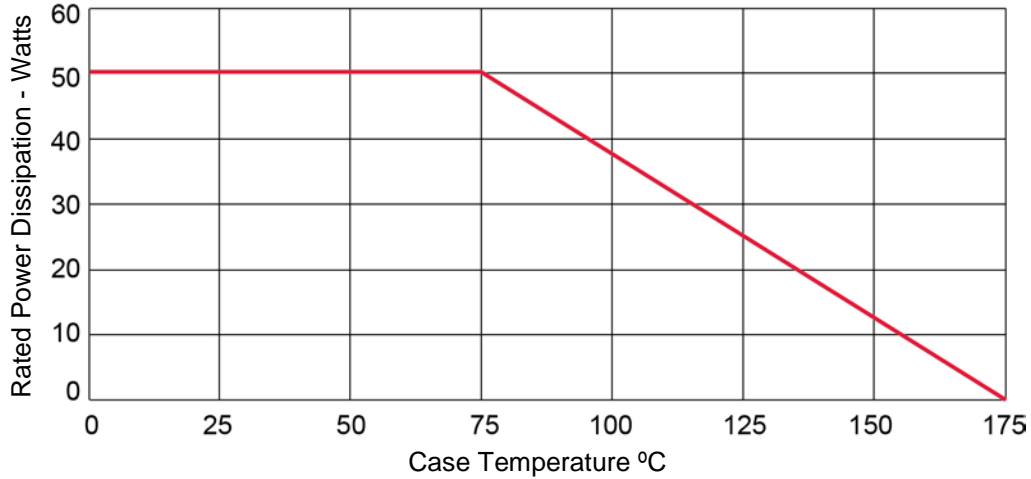
GRAPHS


FIGURE 1
Power Derating Curve

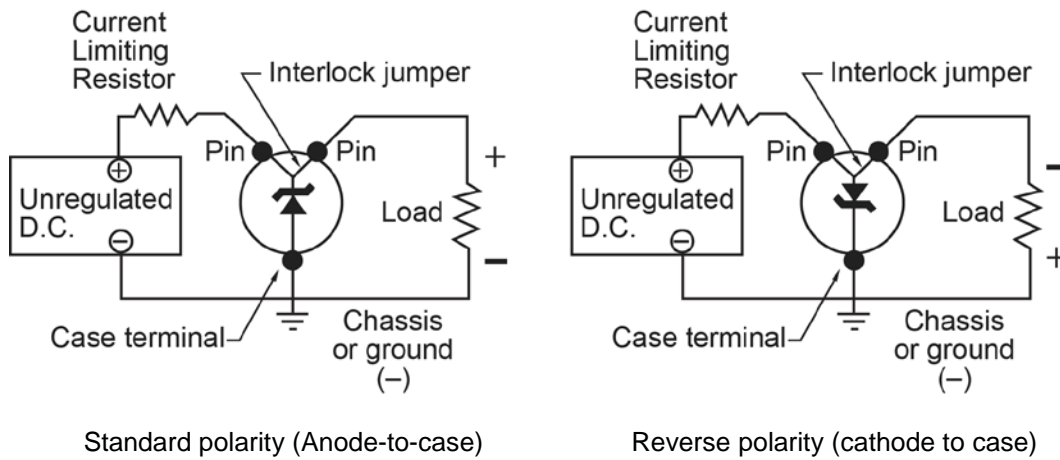
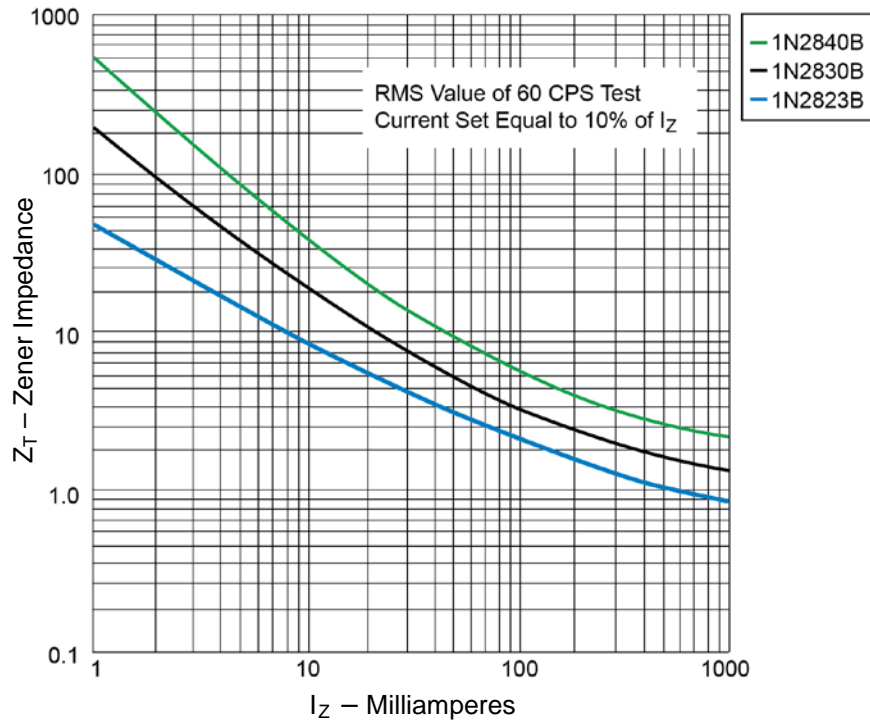
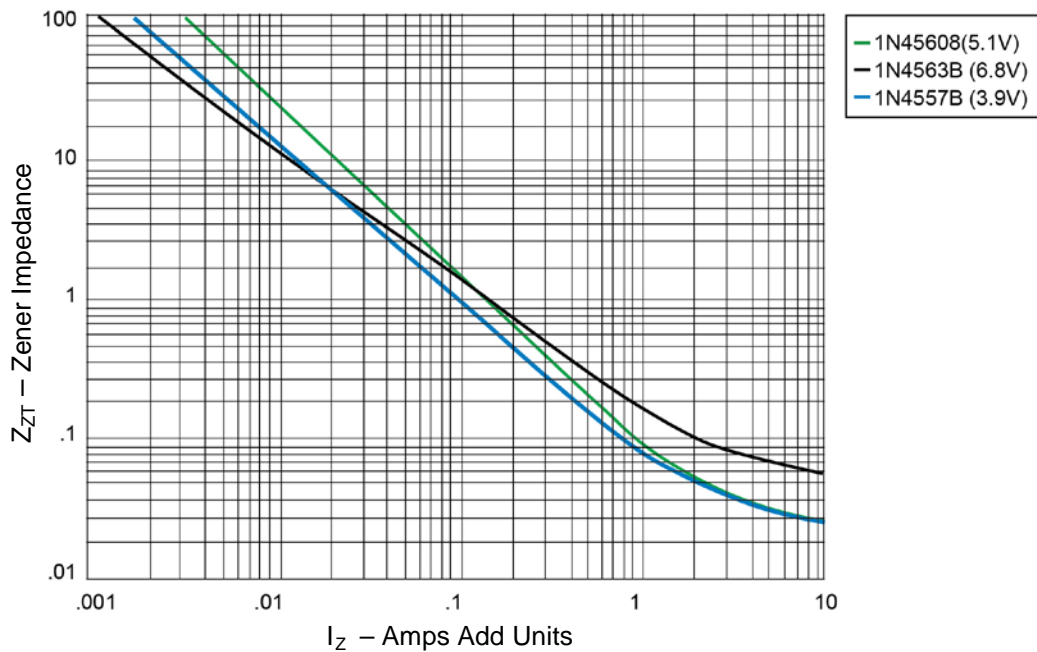


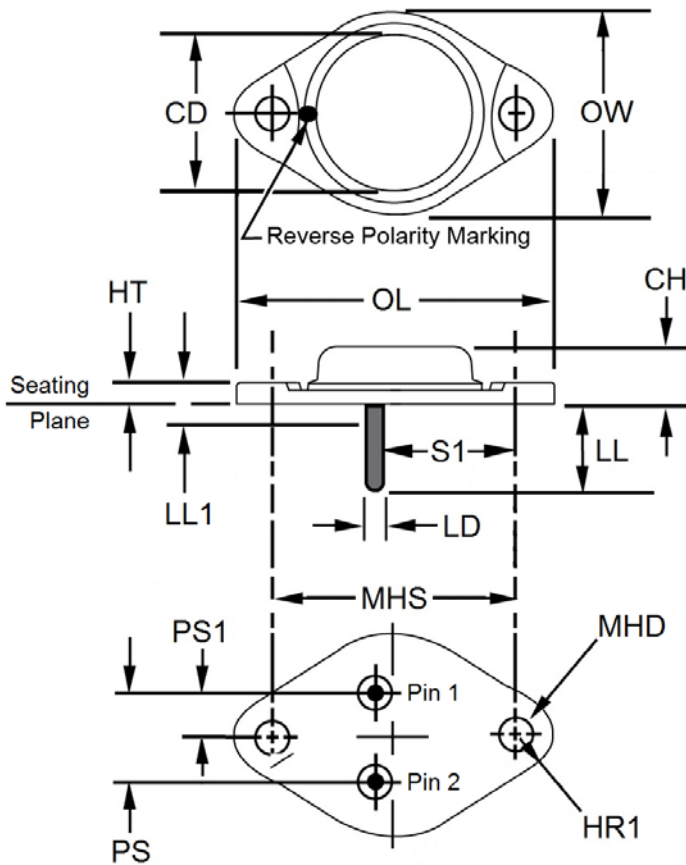
FIGURE 2
Typical circuit connections for anode-to-case and cathode-to-case polarities

GRAPHS

FIGURE 3

Typical Zener Impedance vs Zener Current for Types Shown


FIGURE 4

Typical Zener Impedance vs Zener Current for Types Shown

PACKAGE DIMENSIONS




Ltr	Dimensions				Notes
	Inches		Millimeters		
	Min	Max	Min	Max	
CD	-	0.875	-	22.23	
CH	0.270	0.380	6.86	9.65	
HR	0.495	0.525	12.57	13.34	
HR1	0.131	0.188	3.33	4.78	
HT	0.060	0.135	1.52	3.43	
LD	0.048	0.053	1.22	1.35	
LL	0.312	0.500	7.92	12.70	
L1	-	0.050	-	1.27	
MHD	0.151	0.165	3.84	4.19	
MHS	1.177	1.197	29.90	30.40	
OL	1.520	1.540	38.61	39.12	
OW	0.900	1.10	22.86	27.94	
PS	0.420	0.440	10.67	11.18	2
PS1	0.205	0.225	5.21	5.72	2
S1	0.655	0.675	16.64	17.15	

NOTES:

1. Dimensions are in inches. Millimeters are given for general information only.
2. These dimensions should be measured at points 0.050 inch (1.27 mm) +0.005 inch (+0.13 mm) –0.000 inch (–0.00 mm) below seating plane.
3. The seating plane of the header shall be flat within 0.001 inch (0.03 mm) concave to 0.004 inch (0.10 mm) convex 0.001 inch (0.03 mm) concave to 0.006 inch (0.15 mm) convex overall.
4. Pins 1 and 2 are internally connected with an internal jumper.
5. Devices with RB suffix (reverse polarity) have the cathode internally connected to the case.
6. In accordance with ASME Y14.5M, diameters are equivalent to Φ x symbology.

Looking for pricing, stock, or lifecycle information?

Click below to explore more details on WIN SOURCE:

-  [View 1N2845B on WIN SOURCE](#)
-  [Microsemi Corporation](#) Information

Optimize Your Supply Chain with WIN SOURCE Solutions

-  Global Sourcing Solution
-  Obsolete Management
-  Cost Control Management
-  Shortage Management
-  Alternative Solution
-  Excess Inventory Management