



**THE DATASHEET OF  
DDA143TU-7**



**PNP PRE-BIASED SMALL SIGNAL DUAL SURFACE MOUNT TRANSISTOR**
**Features**

- Epitaxial Planar Die Construction
- Complementary NPN Types Available (DDC)
- Built-In Biasing Resistors
- **Totally Lead-Free & Fully RoHS Compliant (Notes 1 & 2)**
- **Halogen and Antimony Free. "Green" Device (Note 3)**
- **Qualified to AEC-Q101 Standards for High Reliability**
- **PPAP Capable (Note 4)**

| Part Number | R1 (NOM) | R2 (NOM) |
|-------------|----------|----------|
| DDA124EU    | 22kΩ     | 22kΩ     |
| DDA144EU    | 47kΩ     | 47kΩ     |
| DDA114YU    | 10kΩ     | 47kΩ     |
| DDA123JU    | 2.2kΩ    | 47kΩ     |
| DDA114EU    | 10kΩ     | 10kΩ     |

**Mechanical Data**

- Case: SOT363
- Case Material: Molded Plastic, "Green" Molding Compound
- UL Flammability Classification Rating 94V-0
- Moisture Sensitivity: Level 1 per J-STD-020
- Terminals: Finish – Matte Tin Plated Leads, Solderable per MIL-STD-202, Method 208 Ⓢ3
- Weight: 0.006 grams (Approximate)

| Part Number | R1 Only |
|-------------|---------|
| DDA113TU    | 1kΩ     |
| DDA143TU    | 4.7kΩ   |
| DDA114TU    | 10kΩ    |



Top View

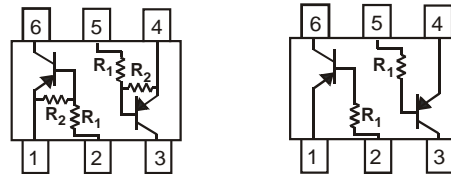

R1, R2

R1 Only

Device Schematic

**Ordering Information** (Notes 4, 5 & 6)

| Product        | Status               | Compliance | Marking | Reel Size (inches) | Tape Width (mm) | Quantity per Reel |
|----------------|----------------------|------------|---------|--------------------|-----------------|-------------------|
| DDA124EU-7-F   | Active               | AEC-Q101   | P17     | 7                  | 8               | 3,000             |
| DDA124EUQ-7-F  | Active               | Automotive | P17     | 7                  | 8               | 3,000             |
| DDA124EUQ-13-F | Active               | Automotive | P17     | 13                 | 8               | 10,000            |
| DDA144EU-7-F   | Active               | AEC-Q101   | P20     | 7                  | 8               | 3,000             |
| DDA144EUQ-7-F  | Active               | Automotive | P20     | 7                  | 8               | 3,000             |
| DDA114YU-7-F   | Active               | AEC-Q101   | P14     | 7                  | 8               | 3,000             |
| DDA114YUQ-7-F  | NRND (Use ADA114YUQ) | Automotive | P14     | 7                  | 8               | 3,000             |
| DDA123JU-7-F   | Active               | AEC-Q101   | P06     | 7                  | 8               | 3,000             |
| DDA114EU-7-F   | Active               | AEC-Q101   | P13     | 7                  | 8               | 3,000             |
| DDA114EUQ-7-F  | NRND (Use ADA114EUQ) | Automotive | P13     | 7                  | 8               | 3,000             |
| DDA113TU-7-F   | Active               | AEC-Q101   | P01     | 7                  | 8               | 3,000             |
| DDA143TU-7-F   | Active               | AEC-Q101   | P07     | 7                  | 8               | 3,000             |
| DDA143TUQ-7-F  | Active               | Automotive | P07     | 7                  | 8               | 3,000             |
| DDA143TUQ-13-F | Active               | Automotive | P07     | 13                 | 8               | 10,000            |
| DDA114TU-7-F   | Active               | AEC-Q101   | P12     | 7                  | 8               | 3,000             |
| DDA114TUQ-7-F  | Active               | Automotive | P12     | 7                  | 8               | 3,000             |
| DDA114TUQ-13-F | Active               | Automotive | P12     | 13                 | 8               | 10,000            |

- Notes:
1. No purposely added lead. Fully EU Directive 2002/95/EC (RoHS), 2011/65/EU (RoHS 2) & 2015/863/EU (RoHS 3) compliant.
  2. See <https://www.diodes.com/quality/lead-free/> for more information about Diodes Incorporated's definitions of Halogen- and Antimony-free, "Green" and Lead-free.
  3. Halogen- and Antimony-free "Green" products are defined as those which contain <900ppm bromine, <900ppm chlorine (<1500ppm total Br + Cl) and <1000ppm antimony compounds.
  4. Automotive products are AEC-Q101 qualified and are PPAP capable. Automotive, AEC-Q101 and standard products are electrically and thermally the same, except where specified. For more information, please refer to <http://www.diodes.com/quality/>.
  5. For packaging details, go to our website at <https://www.diodes.com/design/support/packageing/diodes-packaging/>.
  6. NRND = Not Recommended for New Design.

## Marking Information

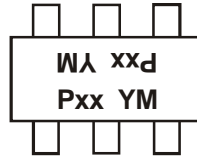

Pxx = Product Type Marking Code (See Ordering Information)  
 YM = Date Code Marking  
 Y = Year (ex: F = 2018)  
 M = Month (ex: 9 = September)

### Date Code Key

| Year | 2018 | 2019 | 2020 | 2021 | 2022 | 2023 | 2024 | 2025 | 2026 | 2027 | 2028 | 2029 | 2030 | 2031 |
|------|------|------|------|------|------|------|------|------|------|------|------|------|------|------|
| Code | F    | G    | H    | I    | J    | K    | L    | M    | N    | O    | P    | Q    | R    | S    |

| Month | Jan | Feb | Mar | Apr | May | Jun | Jul | Aug | Sep | Oct | Nov | Dec |
|-------|-----|-----|-----|-----|-----|-----|-----|-----|-----|-----|-----|-----|
| Code  | 1   | 2   | 3   | 4   | 5   | 6   | 7   | 8   | 9   | O   | N   | D   |

## Absolute Maximum Ratings (@T<sub>A</sub> = +25°C, unless otherwise specified.)

| Characteristic                           | Symbol              | Value   | Unit |
|--|---------------------|---|------|
| Supply Voltage (1) to (6) and (4) to (3) | V <sub>CC</sub>     | -50   | V    |
| Input Voltage (1) to (2) and (4) to (5)  | V <sub>IN</sub>     | +10 to -40<br>+10 to -40<br>+6 to -40<br>+5 to -12<br>+10 to -40<br>+5V Max<br>+5V Max<br>+5V Max | V    |
| Output Current                           | I <sub>O</sub>      | -30<br>-30<br>-70<br>-100<br>-50<br>-100<br>-100<br>-100  | mA   |
| Output Current                           | I <sub>C(MAX)</sub> | -100  | mA   |

## Thermal Characteristics (@T<sub>A</sub> = +25°C, unless otherwise specified.)

| Characteristic                                       | Symbol                            | Value       | Unit |
|--|-----------------------------------|-------------|------|
| Power Dissipation (Notes 7 & 8)                      | P <sub>D</sub>                    | 200         | mW   |
| Thermal Resistance, Junction to Ambient Air (Note 7) | R <sub>θJA</sub>                  | 625         | °C/W |
| Operating and Storage Temperature Range              | T <sub>J</sub> , T <sub>STG</sub> | -55 to +150 | °C   |

Notes: 7. Mounted on FR-4 PC Board with minimum recommended pad layout.  
 8. 150mW per element must not be exceeded.

**Electrical Characteristics** (@T<sub>A</sub> = +25°C, unless otherwise specified.)

| Characteristic<br>(DDA113TU & DDA143TU & DDA114TU only) | Symbol               | Min        | Typ      | Max      | Unit | Test Condition  |
|---|----------------------|------------|----------|----------|------|---|
| Collector-Base Breakdown Voltage                        | BV <sub>CBO</sub>    | -50        | —        | —        | V    | I <sub>C</sub> = -50μA  |
| Collector-Emitter Breakdown Voltage                     | BV <sub>CEO</sub>    | -50        | —        | —        | V    | I <sub>C</sub> = -1mA   |
| Emitter-Base Breakdown Voltage                          | BV <sub>EBO</sub>    | -5         | —        | —        | V    | I <sub>E</sub> = -50μA  |
| Collector Cutoff Current                                | I <sub>CBO</sub>     | —          | —        | -0.5     | μA   | V <sub>CB</sub> = -50V  |
| Emitter Cutoff Current                                  | I <sub>EBO</sub>     | —          | —        | -0.5     | μA   | V <sub>EB</sub> = -4V   |
| Collector-Emitter Saturation Voltage                    | V <sub>CE(SAT)</sub> | —          | —        | -0.3     | V    | I <sub>C</sub> /I <sub>B</sub> = -2.5mA / -0.25mA DDA143TU<br>I <sub>C</sub> /I <sub>B</sub> = -1mA / -0.1mA DDA114TU<br>I <sub>C</sub> /I <sub>B</sub> = -10mA / -1mA DDA113TU |
| DC Current Transfer Ratio                               | h <sub>FE</sub>      | 100<br>160 | 250<br>— | 600<br>— | —    | I <sub>C</sub> = -1mA, V <sub>CE</sub> = -5V<br>I <sub>C</sub> = -1mA, V <sub>CE</sub> = -5V DDA143TUQ  |
| Input Resistor (R <sub>1</sub> ) Tolerance              | ΔR <sub>1</sub>      | -30        | —        | +30      | %    | —   |
| Gain-Bandwidth Product (Note 9)                         | f <sub>T</sub>       | —          | 250      | —        | MHz  | V <sub>CE</sub> = -10V, I <sub>E</sub> = 5mA, f = 100MHz  |

| Characteristic                             | Symbol                         | Min                              | Typ  | Max                                      | Unit | Test Condition   |   |
|--|--------------------------------|----------------------------------|------|--|------|--|---|
| Input Voltage                              | V <sub>I(OFF)</sub>            | DDA124EU                         | -0.5 | -1.1                                     | —    | V  | V <sub>CC</sub> = -5V, I <sub>O</sub> = -100μA  |
|  |                                | DDA144EU                         | -0.5 | -1.1                                     |      |  |   |
| DDA114YU                                   |                                | -0.3                             | —    |  |      |  |   |
| DDA123JU                                   |                                | -0.5                             | —    |  |      |  |   |
| DDA114EU                                   |                                | -0.5                             | -1.1 |  |      |  |   |
| Input Voltage                              | V <sub>I(ON)</sub>             | DDA124EU                         | —    | -1.9                                     | -3.0 | V  | V <sub>O</sub> = -0.3, I <sub>O</sub> = -5mA<br>V <sub>O</sub> = -0.3, I <sub>O</sub> = -2mA<br>V <sub>O</sub> = -0.3, I <sub>O</sub> = -1mA<br>V <sub>O</sub> = -0.3, I <sub>O</sub> = -5mA<br>V <sub>O</sub> = -0.3, I <sub>O</sub> = -10mA |
|  |                                | DDA144EU                         | —    | -1.9                                     | -3.0 |  |   |
|  |                                | DDA114YU                         | —    | —  | -1.4 |  |   |
|  |                                | DDA123JU                         | —    | —  | -1.1 |  |   |
|  |                                | DDA114EU                         | —    | -1.9                                     | -3.0 |  |   |
| Output Voltage                             | V <sub>O(ON)</sub>             | —                                | -0.1 | -0.3                                     | V    | I <sub>O</sub> /I <sub>I</sub> = -10mA / -0.5mA<br>I <sub>O</sub> /I <sub>I</sub> = -10mA / -0.5mA<br>I <sub>O</sub> /I <sub>I</sub> = -5mA / -0.25mA<br>I <sub>O</sub> /I <sub>I</sub> = -5mA / -0.25mA<br>I <sub>O</sub> /I <sub>I</sub> = -10mA / -0.5mA                              |   |
| Input Current                              | I <sub>I</sub>                 | —                                | —    | -0.36<br>-0.18<br>-0.88<br>-3.6<br>-0.88 | mA   | V <sub>I</sub> = -5V   |   |
| Output Current                             | I <sub>O(OFF)</sub>            | —                                | —    | -0.5                                     | μA   | V <sub>CC</sub> = -50V, V <sub>I</sub> = -0V   |   |
| DC Current Gain                            | G <sub>I</sub>                 | 56<br>60<br>68<br>68<br>80<br>30 | —    | —  | —    | V <sub>O</sub> = -5V, I <sub>O</sub> = -5mA<br>V <sub>O</sub> = -5V, I <sub>O</sub> = -5mA<br>V <sub>O</sub> = -5V, I <sub>O</sub> = -5mA<br>V <sub>O</sub> = -5V, I <sub>O</sub> = -10mA<br>V <sub>O</sub> = -5V, I <sub>O</sub> = -10mA<br>V <sub>O</sub> = -5V, I <sub>O</sub> = -5mA |   |
| Input Resistor (R <sub>1</sub> ) Tolerance | ΔR <sub>1</sub>                | -30                              | —    | +30                                      | %    | —  |   |
| Resistance Ratio Tolerance                 | R <sub>2</sub> /R <sub>1</sub> | -20                              | —    | +20                                      | %    | —  |   |
| Gain-Bandwidth Product                     | f <sub>T</sub>                 | —                                | 250  | —  | MHz  | V <sub>CE</sub> = -10V, I <sub>E</sub> = -5mA, f = 100MHz  |   |

Note: 9. Transistor - For Reference Only.

**Typical Curves – DDA123JU** (@ $T_A = +25^\circ\text{C}$ , unless otherwise specified.)

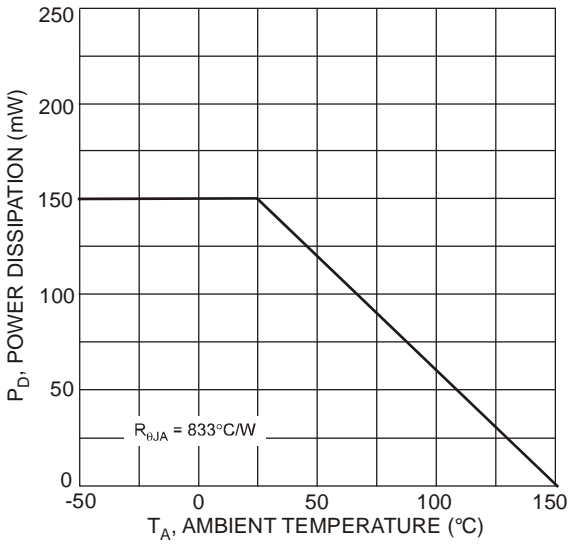

Fig. 1 Power Dissipation vs. Ambient Temperature

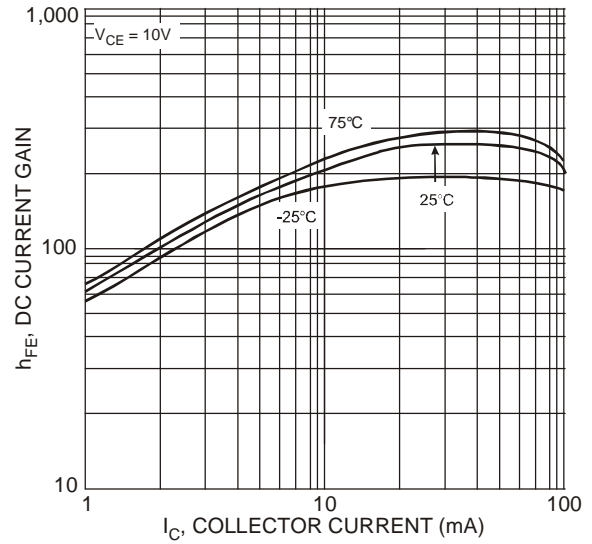

Fig. 2 Typical DC Current Gain vs. Collector Current

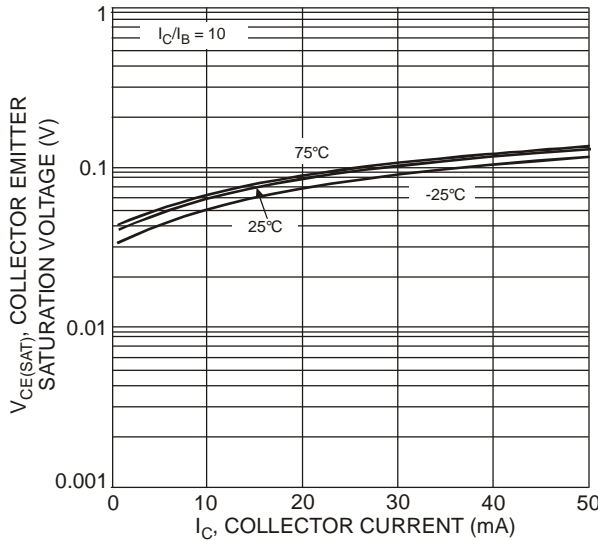

Fig. 3 Typical Collector Emitter Saturation Voltage vs. Collector Current

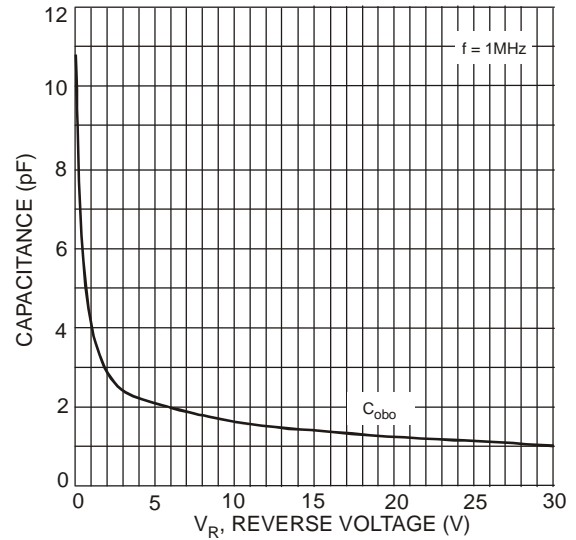

Fig. 4 Typical Capacitance Characteristics

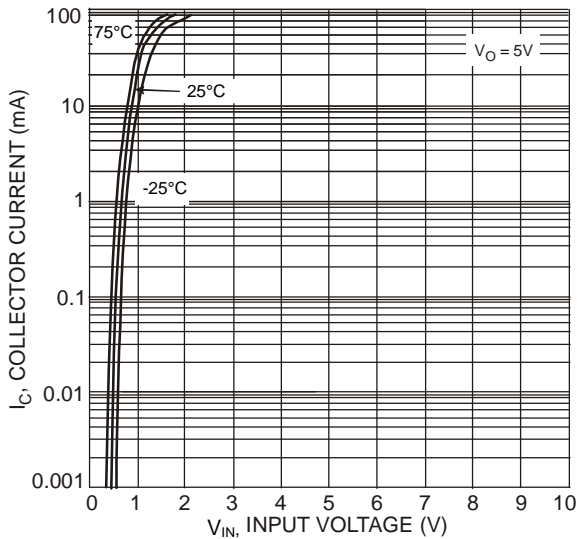

Fig. 5 Collector Current vs. Input Voltage

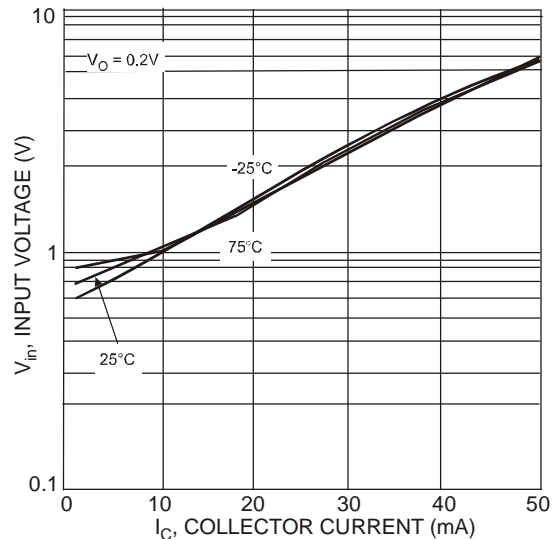

Fig. 6 Input Voltage vs. Collector Current

**Typical Curves – DDA114TU** (@ $T_A = +25^\circ\text{C}$ , unless otherwise specified.)

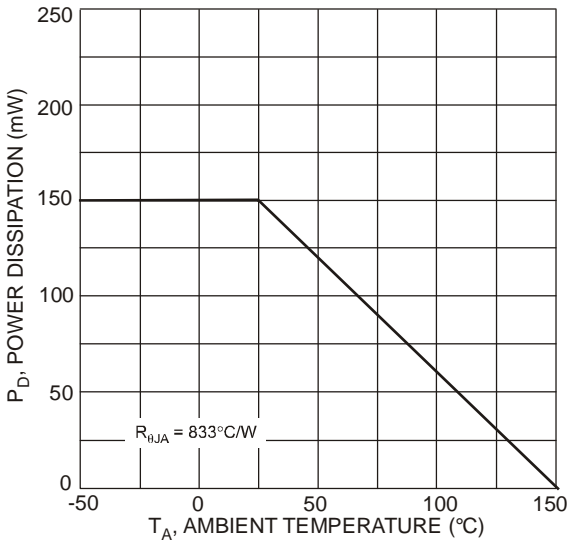

Fig.7 Power Dissipation vs. Ambient Temperature

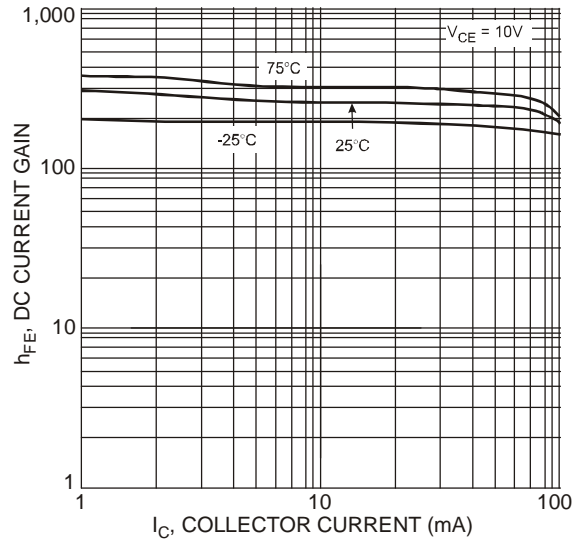

Fig.8 Typical DC Current Gain vs. Collector Current

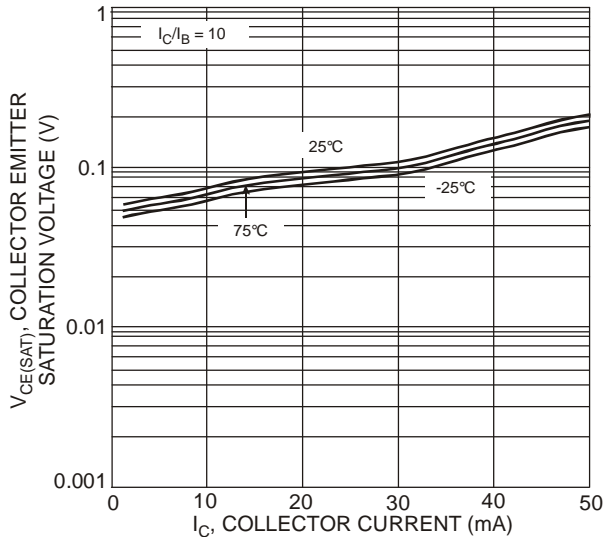

Fig.9 Typical Collector Emitter Saturation Voltage vs. Collector Current

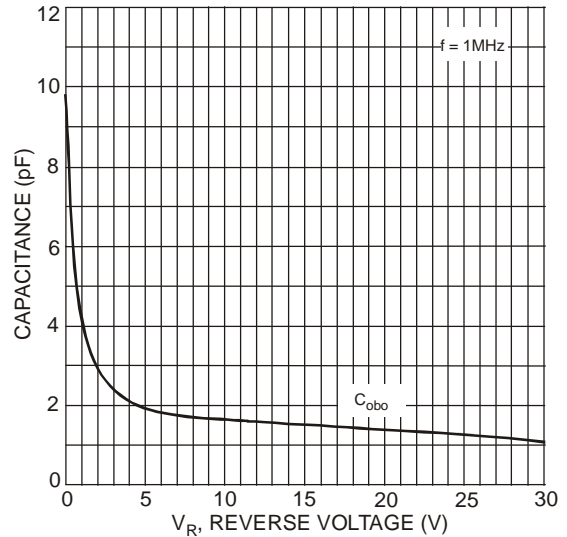

Fig.10 Typical Capacitance Characteristics

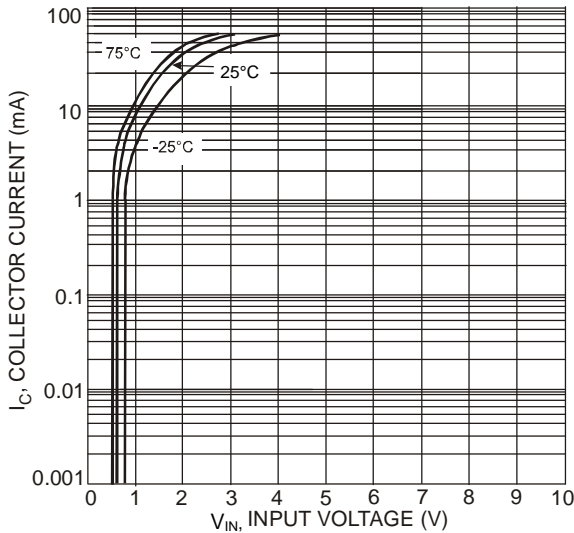

Fig.11 Collector Current vs. Input Voltage

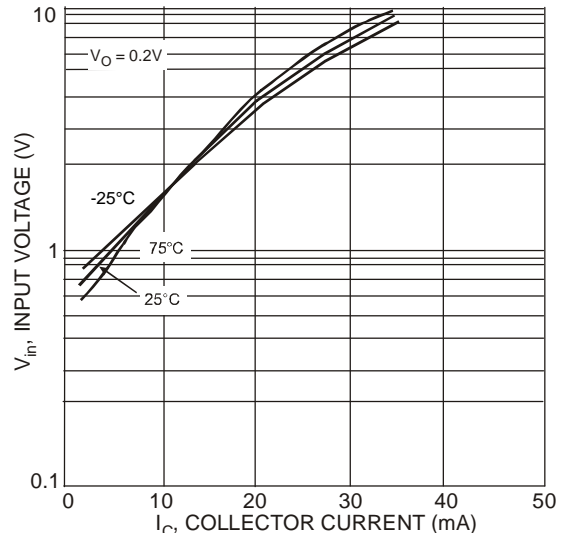
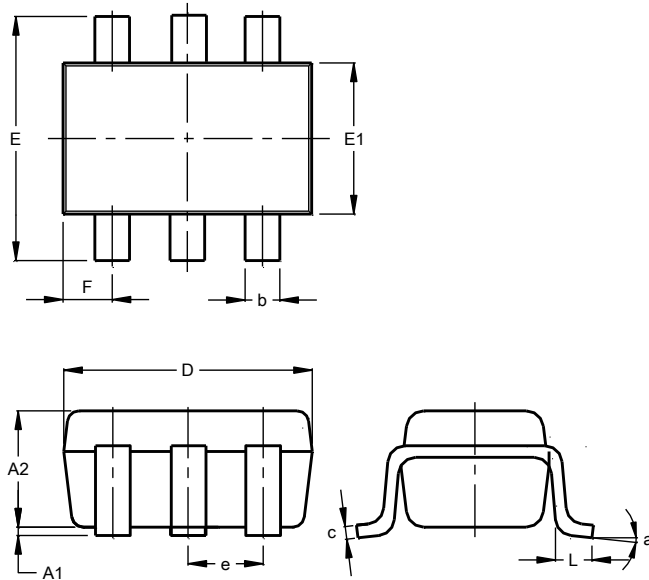

Fig.12 Input Voltage vs. Collector Current

## Package Outline Dimensions

Please see <http://www.diodes.com/package-outlines.html> for the latest version.

### SOT363



| SOT363               |           |      |       |
|----------------------|-----------|------|-------|
| Dim                  | Min       | Max  | Typ   |
| A1                   | 0.00      | 0.10 | 0.05  |
| A2                   | 0.90      | 1.00 | 0.95  |
| b                    | 0.10      | 0.30 | 0.25  |
| c                    | 0.10      | 0.22 | 0.11  |
| D                    | 1.80      | 2.20 | 2.15  |
| E                    | 2.00      | 2.20 | 2.10  |
| E1                   | 1.15      | 1.35 | 1.30  |
| e                    | 0.650 BSC |      |       |
| F                    | 0.40      | 0.45 | 0.425 |
| L                    | 0.25      | 0.40 | 0.30  |
| a                    | 0°        | 8°   | --    |
| All Dimensions in mm |           |      |       |

## Suggested Pad Layout

Please see <http://www.diodes.com/package-outlines.html> for the latest version.

### SOT363

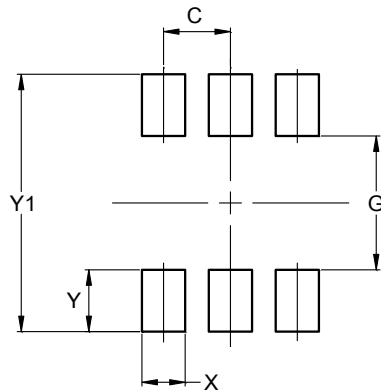

| Dimensions | Value (in mm) |
|------------|---------------|
| C          | 0.650         |
| G          | 1.300         |
| X          | 0.420         |
| Y          | 0.600         |
| Y1         | 2.500         |

**IMPORTANT NOTICE**

DIODES INCORPORATED MAKES NO WARRANTY OF ANY KIND, EXPRESS OR IMPLIED, WITH REGARDS TO THIS DOCUMENT, INCLUDING, BUT NOT LIMITED TO, THE IMPLIED WARRANTIES OF MERCHANTABILITY AND FITNESS FOR A PARTICULAR PURPOSE (AND THEIR EQUIVALENTS UNDER THE LAWS OF ANY JURISDICTION).

Diodes Incorporated and its subsidiaries reserve the right to make modifications, enhancements, improvements, corrections or other changes without further notice to this document and any product described herein. Diodes Incorporated does not assume any liability arising out of the application or use of this document or any product described herein; neither does Diodes Incorporated convey any license under its patent or trademark rights, nor the rights of others. Any Customer or user of this document or products described herein in such applications shall assume all risks of such use and will agree to hold Diodes Incorporated and all the companies whose products are represented on Diodes Incorporated website, harmless against all damages.

Diodes Incorporated does not warrant or accept any liability whatsoever in respect of any products purchased through unauthorized sales channel. Should Customers purchase or use Diodes Incorporated products for any unintended or unauthorized application, Customers shall indemnify and hold Diodes Incorporated and its representatives harmless against all claims, damages, expenses, and attorney fees arising out of, directly or indirectly, any claim of personal injury or death associated with such unintended or unauthorized application.

Products described herein may be covered by one or more United States, international or foreign patents pending. Product names and markings noted herein may also be covered by one or more United States, international or foreign trademarks.

This document is written in English but may be translated into multiple languages for reference. Only the English version of this document is the final and determinative format released by Diodes Incorporated.

**LIFE SUPPORT**

Diodes Incorporated products are specifically not authorized for use as critical components in life support devices or systems without the express written approval of the Chief Executive Officer of Diodes Incorporated. As used herein:

A. Life support devices or systems are devices or systems which:

1. are intended to implant into the body, or
2. support or sustain life and whose failure to perform when properly used in accordance with instructions for use provided in the labeling can be reasonably expected to result in significant injury to the user.

B. A critical component is any component in a life support device or system whose failure to perform can be reasonably expected to cause the failure of the life support device or to affect its safety or effectiveness.



Customers represent that they have all necessary expertise in the safety and regulatory ramifications of their life support devices or systems, and acknowledge and agree that they are solely responsible for all legal, regulatory and safety-related requirements concerning their products and any use of Diodes Incorporated products in such safety-critical, life support devices or systems, notwithstanding any devices- or systems-related information or support that may be provided by Diodes Incorporated. Further, Customers must fully indemnify Diodes Incorporated and its representatives against any damages arising out of the use of Diodes Incorporated products in such safety-critical, life support devices or systems.

Copyright © 2018, Diodes Incorporated

[www.diodes.com](http://www.diodes.com)

## Looking for pricing, stock, or lifecycle information?

Click below to explore more details on WIN SOURCE:

-  [View DDA143TU-7 on WIN SOURCE](#)
-  [Diodes Incorporated Information](#)

## Optimize Your Supply Chain with WIN SOURCE Solutions

-  Global Sourcing Solution
-  Obsolete Management
-  Cost Control Management
-  Shortage Management
-  Alternative Solution
-  Excess Inventory Management