



**THE DATASHEET OF  
NCP4625DSN18T1G**



# NCP4625

## 300 mA, 10 V, Low Dropout Regulator

The NCP4625 is a CMOS Linear voltage regulator with 300 mA output current capability. The device is capable of operating with input voltages up to 10 V, with high output voltage accuracy and low temperature–drift coefficient. The NCP4625 is easy to use, with output current fold–back protection and a thermal shutdown circuit included. A Chip Enable function is included to save power by lowering supply current.

### Features

- Operating Input Voltage Range: 2.6 V to 10 V
- Output Voltage Range: 1.2 to 6.0 V (available in 0.1 V steps)
- Low Supply Current: 23  $\mu$ A
- Very Low Dropout:
  - ◆ 200 mV ( $I_{OUT} = 100$  mA,  $V_{IN} = 3.0$  V)
  - ◆ 770 mV ( $I_{OUT} = 300$  mA,  $V_{IN} = 2.8$  V)
- High PSRR: 70 dB at 1 kHz
- Line Regulation 0.02%/V Typ
- Current Fold Back Protection
- Thermal Shutdown Protection
- Stable with Ceramic Capacitors
- Available in SC–70, SOT89 and SOT–23 Package
- These are Pb–Free Devices

### Typical Applications

- Battery products powered by Two Lithium Ion cells
- Networking and Communication Equipment
- Cameras, DVRs, STB and Camcorders
- Toys, industrial applications

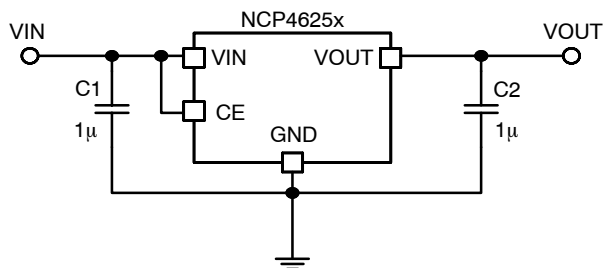

Figure 1. Typical Application Schematic



ON Semiconductor™

<http://onsemi.com>

### MARKING DIAGRAMS



SC–70  
CASE 419A

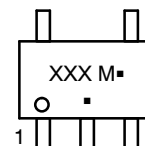

SOT–89 5  
CASE 528AB

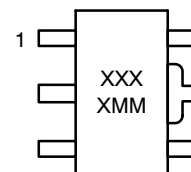

SOT–23–5  
CASE 1212

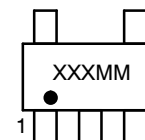

XX, XXX= Specific Device Code  
M, MM = Date Code  
A = Assembly Location  
Y = Year  
W = Work Week  
▪ = Pb–Free Package

(\*Note: Microdot may be in either location)

### ORDERING INFORMATION

See detailed ordering and shipping information in the package dimensions section on page 14 of this data sheet.

# NCP4625

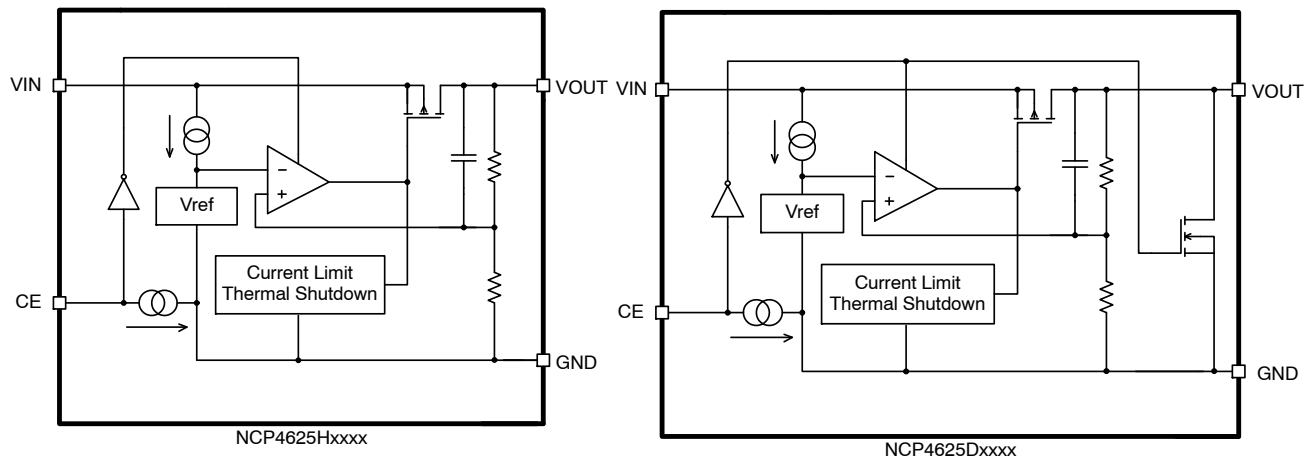

Figure 2. Simplified Schematic Block Diagram

## PIN FUNCTION DESCRIPTION

Pin No. SOT89	Pin No. SC-70	Pin No. SOT23	Pin Name	Description
5	5	1	VIN	Input pin
2	3	2	GND	Ground
3	1	3	CE	Chip enable pin (Active "H")
1	4	5	VOUT	Output pin
4	2	4	NC	No connection

## ABSOLUTE MAXIMUM RATINGS

Rating	Symbol	Value	Unit
Input Voltage (Note 1)	$V_{IN}$	12.0	V
Output Voltage	$V_{OUT}$	-0.3 to $V_{IN} + 0.3$	V
Chip Enable Input	$V_{CE}$	12.0	V
Output Current	$I_{OUT}$	330	mA
Power Dissipation SOT89	$P_D$	900	mW
Power Dissipation SC-70		380	
Power Dissipation SOT23		420	
Junction Temperature	$T_J$	-40 to 150	°C
Storage Temperature	$T_{STG}$	-55 to 125	°C
ESD Capability, Human Body Model (Note 2)	$ESD_{HBM}$	2000	V
ESD Capability, Machine Model (Note 2)	$ESD_{MM}$	200	V

Stresses exceeding Maximum Ratings may damage the device. Maximum Ratings are stress ratings only. Functional operation above the Recommended Operating Conditions is not implied. Extended exposure to stresses above the Recommended Operating Conditions may affect device reliability.

1. Refer to ELECTRICAL CHARACTERISTICS and APPLICATION INFORMATION for Safe Operating Area.
2. This device series incorporates ESD protection and is tested by the following methods:  
 ESD Human Body Model tested per AEC-Q100-002 (EIA/JESD22-A114)  
 ESD Machine Model tested per AEC-Q100-003 (EIA/JESD22-A115)  
 Latchup Current Maximum Rating tested per JEDEC standard: JESD78.

# NCP4625

## THERMAL CHARACTERISTICS

Rating	Symbol	Value	Unit
Thermal Characteristics, SOT89 Thermal Resistance, Junction-to-Air	$R_{\theta JA}$	111	$^{\circ}\text{C}/\text{W}$
Thermal Characteristics, SOT23 Thermal Resistance, Junction-to-Air	$R_{\theta JA}$	238	$^{\circ}\text{C}/\text{W}$
Thermal Characteristics, SC-70 Thermal Resistance, Junction-to-Air	$R_{\theta JA}$	263	$^{\circ}\text{C}/\text{W}$

**ELECTRICAL CHARACTERISTICS**  $-40^{\circ}\text{C} \leq T_A \leq 85^{\circ}\text{C}$ ;  $V_{IN} = V_{OUT(NOM)} + 1\text{ V}$ ;  $I_{OUT} = 1\text{ mA}$ ,  $C_{IN} = C_{OUT} = 0.47\text{ }\mu\text{F}$ , unless otherwise noted. Typical values are at  $T_A = +25^{\circ}\text{C}$ .

Parameter	Test Conditions	Symbol	Min	Typ	Max	Unit	
Operating Input Voltage		$V_{IN}$	2.6		10	V	
Output Voltage	$T_A = +25^{\circ}\text{C}$	$V_{OUT} > 1.5\text{ V}$	$V_{OUT}$	x0.99	x1.01	V	
		$V_{OUT} \leq 1.5\text{ V}$		-15	15	mV	
	$-40^{\circ}\text{C} \leq T_A \leq 85^{\circ}\text{C}$	$V_{OUT} > 1.5\text{ V}$	x0.974	x1.023	V		
		$V_{OUT} \leq 1.5\text{ V}$	-40	35	mV		
Output Voltage Temp. Coefficient	$-40^{\circ}\text{C} \leq T_A \leq 85^{\circ}\text{C}$			$\pm 80$		ppm/ $^{\circ}\text{C}$	
Line Regulation	$V_{OUT(NOM)} + 0.5\text{ V}$ or $2.6\text{ V}$ (whichever is higher) $\leq V_{IN} \leq 10\text{ V}$	$\text{LineReg}$		0.02	0.2	%/V	
Load Regulation	$I_{OUT} = 0.1\text{ mA}$ to $300\text{ mA}$	$\text{LineReg}$		10	70	mV	
Dropout Voltage	$I_{OUT} = 300\text{ mA}$	$1.2\text{ V} \leq V_{OUT} < 1.3\text{ V}$	$V_{DO}$		1.40	1.80	V
		$1.3\text{ V} \leq V_{OUT} < 1.5\text{ V}$			1.35	1.75	
		$1.5\text{ V} \leq V_{OUT} < 1.8\text{ V}$			1.20	1.55	
		$1.8\text{ V} \leq V_{OUT} < 2.3\text{ V}$			0.98	1.30	
		$2.3\text{ V} \leq V_{OUT} < 3.0\text{ V}$			0.77	1.08	
		$3.0\text{ V} \leq V_{OUT} < 4.0\text{ V}$			0.60	0.85	
		$4.0\text{ V} \leq V_{OUT} < 6.0\text{ V}$			0.50	0.75	
Output Current		$I_{OUT}$	300			mA	
Short Current Limit	$V_{OUT} = 0\text{ V}$	$I_{SC}$		40		mA	
Quiescent Current		$I_Q$		23	40	$\mu\text{A}$	
Standby Current	$V_{IN} = 10\text{ V}$ , $V_{CE} = 0\text{ V}$ , $T_A = 25^{\circ}\text{C}$	$I_{STB}$		0.1	1.0	$\mu\text{A}$	
CE Pin Threshold Voltage	CE Input Voltage "H"	$V_{CEH}$	1.7			V	
	CE Input Voltage "L"	$V_{CEL}$			0.8		
CE Pull Down Current		$I_{CEPD}$		0.3		$\mu\text{A}$	
Power Supply Rejection Ratio	$V_{IN} = V_{OUT} + 1\text{ V}$ or $3.0\text{ V}$ whichever is higher, $\Delta V_{IN} = 0.2\text{ V}_{pk-pk}$ , $I_{OUT} = 30\text{ mA}$ , $f = 1\text{ kHz}$	PSRR		70		dB	
Output Noise Voltage	$f = 10\text{ Hz}$ to $100\text{ kHz}$	$V_N$		85		$\mu\text{V}_{rms}$	
Low Output N-channel Tr. On Resistance	$V_{IN} = 7\text{ V}$ , $V_{CE} = 0\text{ V}$ , $V_{OUT} = 1.2\text{ V}$ , $V_{IN} = 2.6\text{ V}$ , $I_{OUT} = 30\text{ mA}$	$R_{LOW}$		250		$\Omega$	
Thermal Shutdown Temperature		$T_{TSD}$		165		$^{\circ}\text{C}$	
Thermal Shutdown Release		$T_{TSR}$		110		$^{\circ}\text{C}$	

TYPICAL CHARACTERISTICS

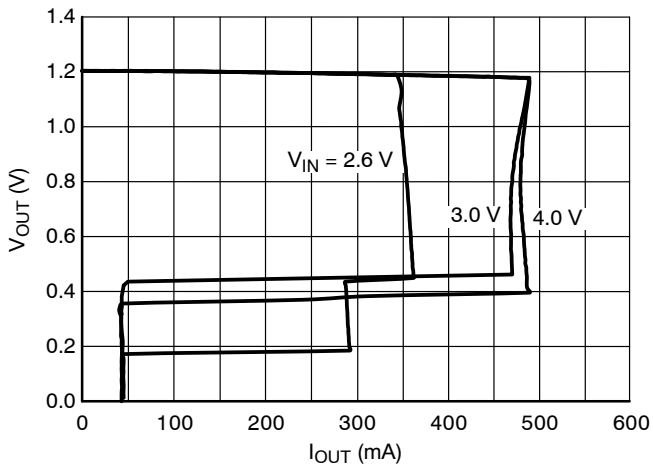

Figure 3. Output Voltage vs. Output Current  
1.2 V Version ( $T_J = 25^\circ\text{C}$ )

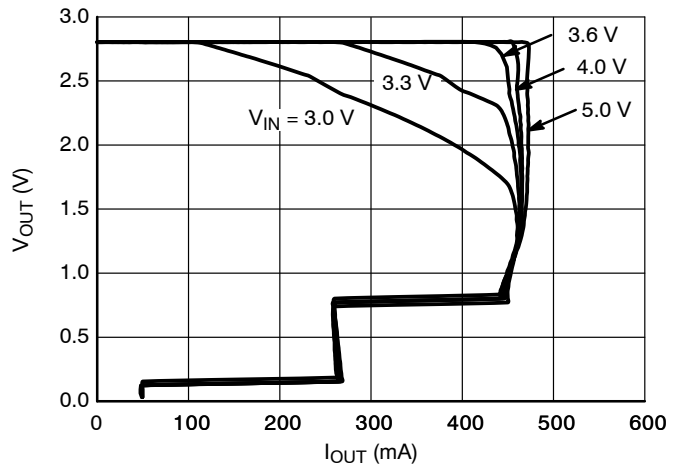

Figure 4. Output Voltage vs. Output Current  
2.8 V Version ( $T_J = 25^\circ\text{C}$ )

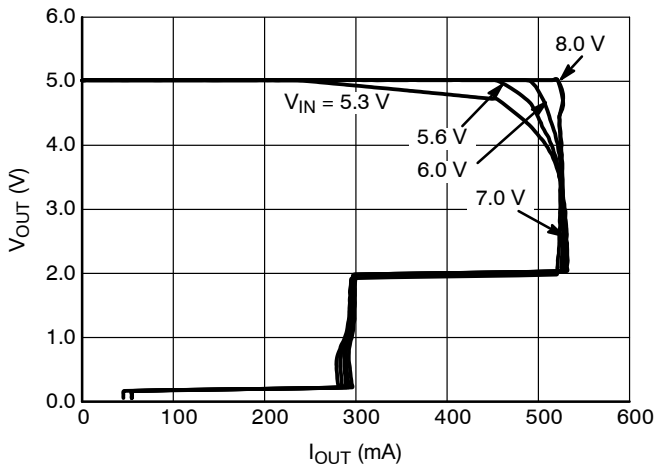

Figure 5. Output Voltage vs. Output Current  
5.0 V Version ( $T_J = 25^\circ\text{C}$ )

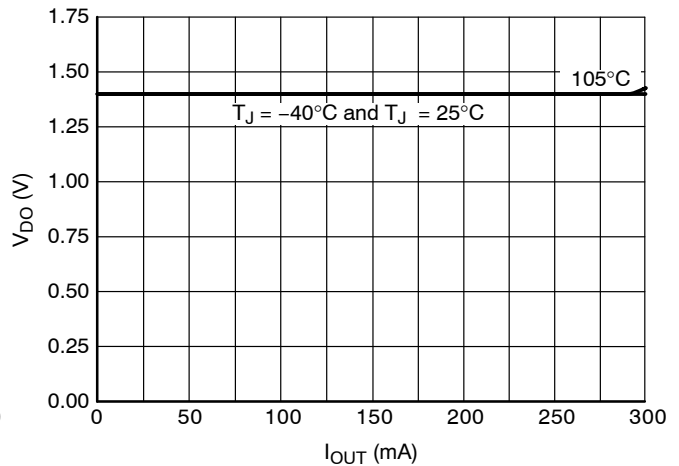

Figure 6. Dropout Voltage vs. Output Current  
1.2 V Version

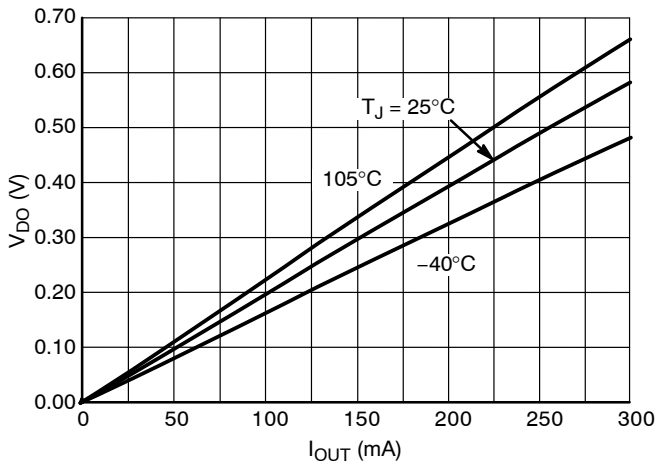

Figure 7. Dropout Voltage vs. Output Current  
2.8 V Version

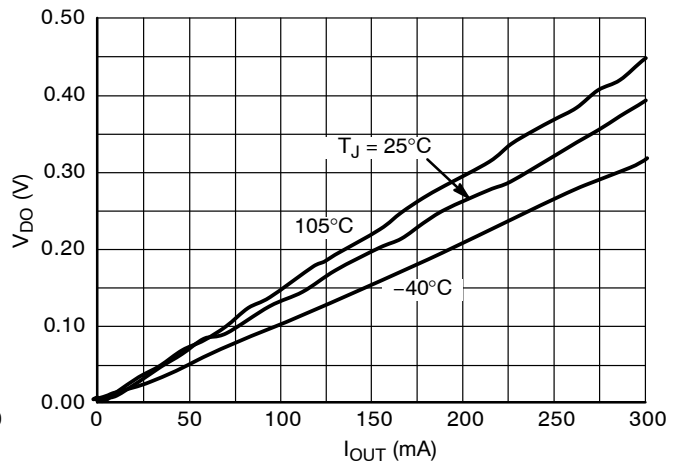

Figure 8. Dropout Voltage vs. Output Current  
5.0 V Version

TYPICAL CHARACTERISTICS

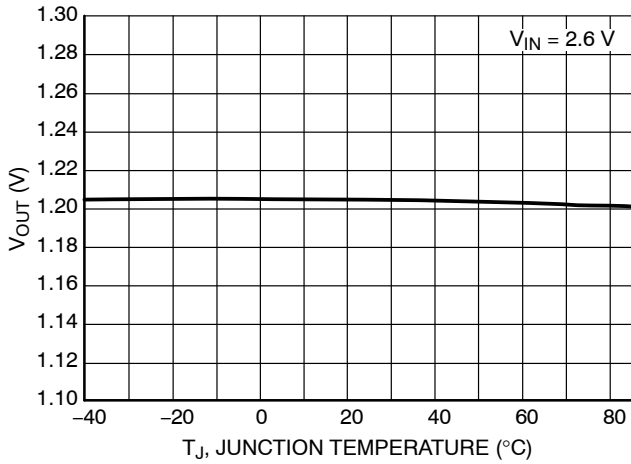

Figure 9. Output Voltage vs. Temperature, 1.2 V Version

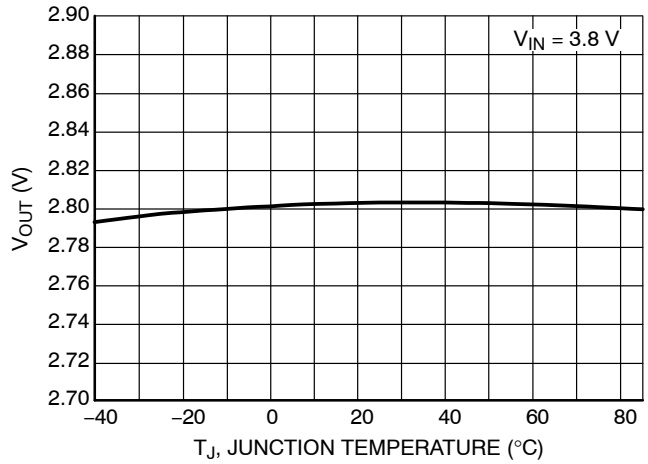

Figure 10. Output Voltage vs. Temperature, 2.8 V Version

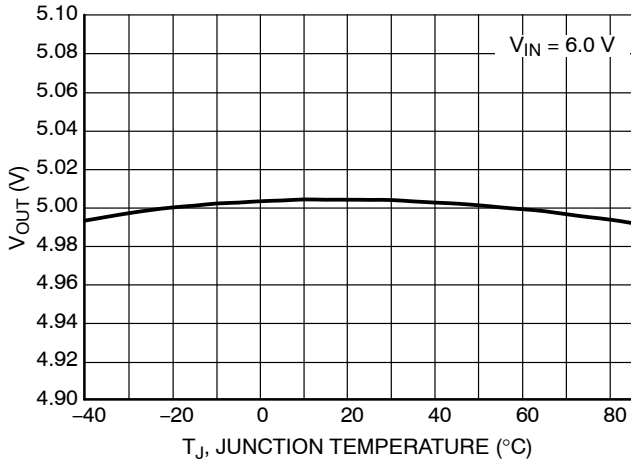

Figure 11. Output Voltage vs. Temperature, 5.0 V Version

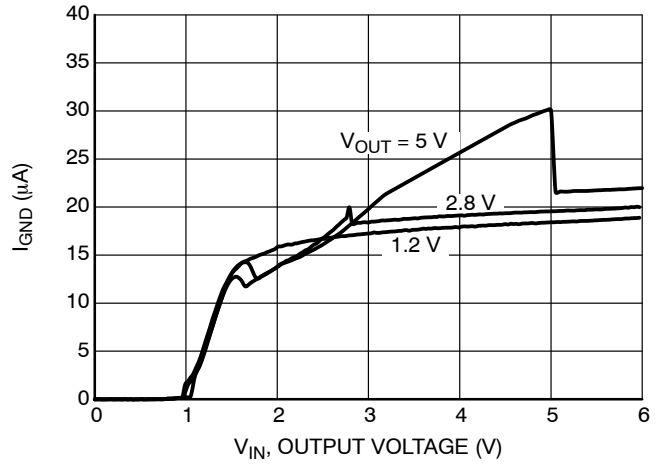

Figure 12. Supply Current vs. Input Voltage

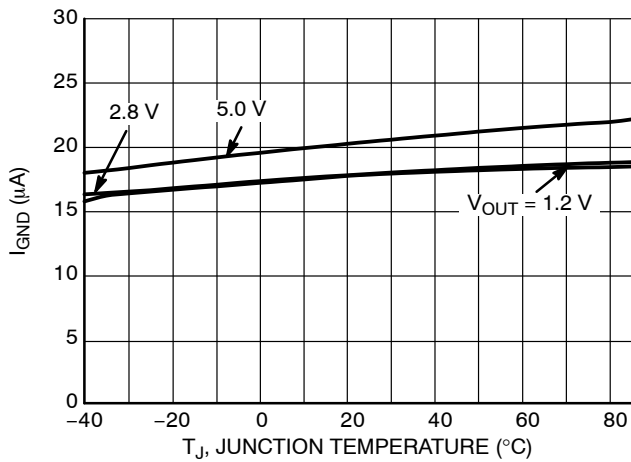

Figure 13. Supply Current vs. Temperature, 1.2 V Version

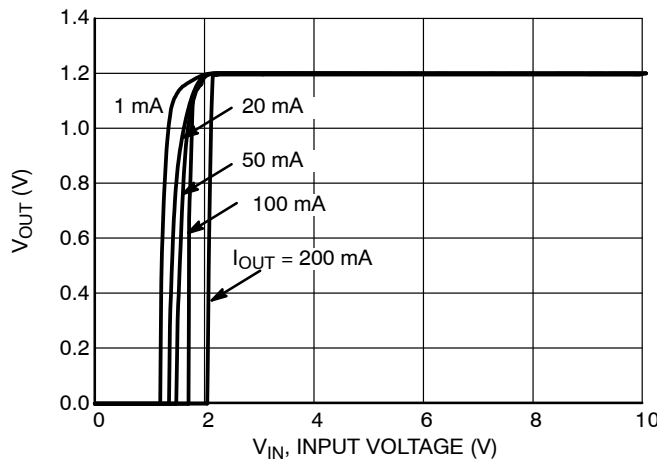

Figure 14. Output Voltage vs. Input Voltage, 1.2 V Version

TYPICAL CHARACTERISTICS

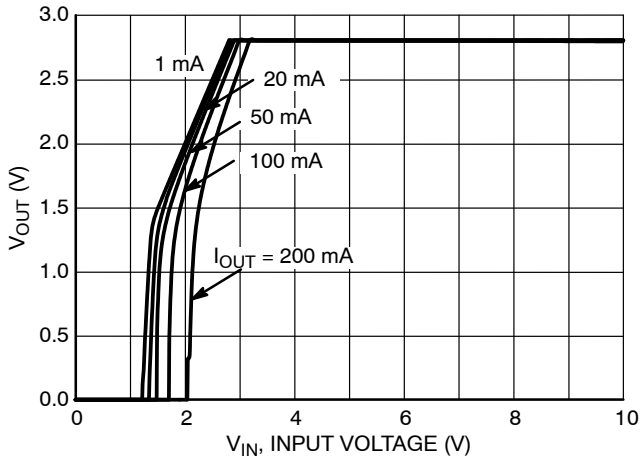

Figure 15. Output Voltage vs. Input Voltage, 2.8 V Version

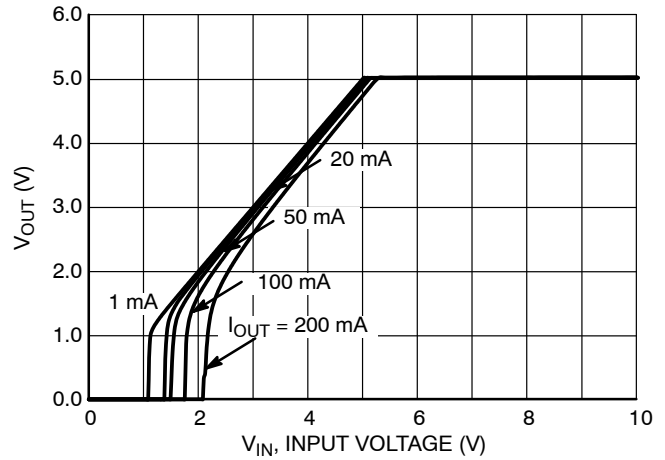

Figure 16. Output Voltage vs. Input Voltage, 5.0 V Version

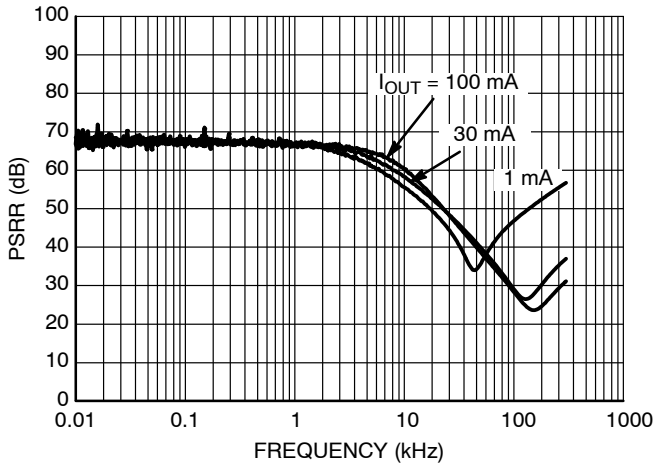

Figure 17. PSRR, 1.2 V Version,  $V_{IN} = 2.6 V$

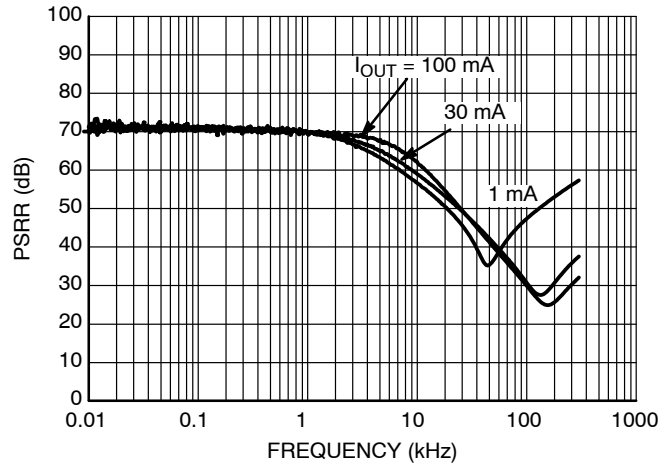

Figure 18. PSRR, 1.2 V Version,  $V_{IN} = 3.0 V$

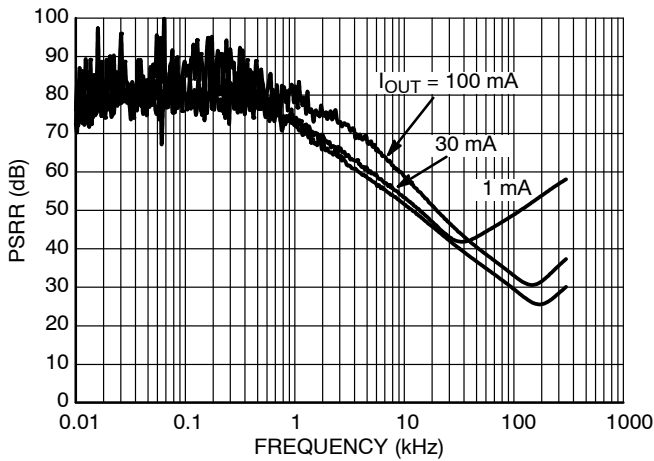

Figure 19. PSRR, 2.8 V Version,  $V_{IN} = 3.8 V$

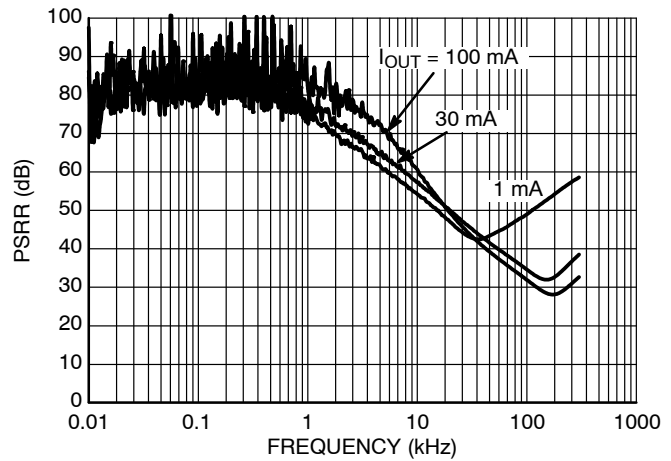

Figure 20. PSRR, 2.8 V Version,  $V_{IN} = 4.8 V$

TYPICAL CHARACTERISTICS

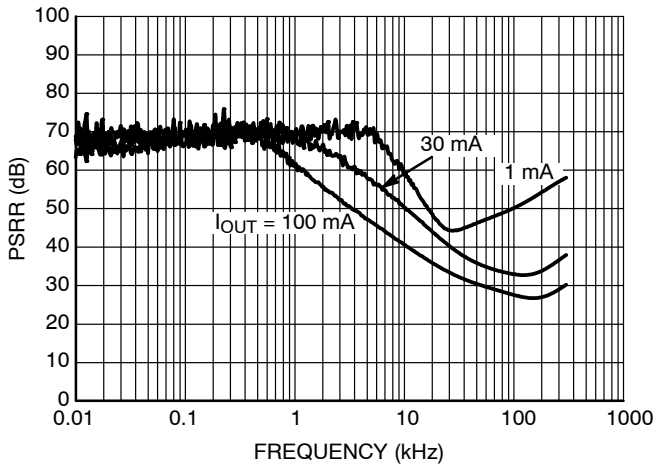

Figure 21. PSRR, 5.0 V Version,  $V_{IN} = 6.0 V$

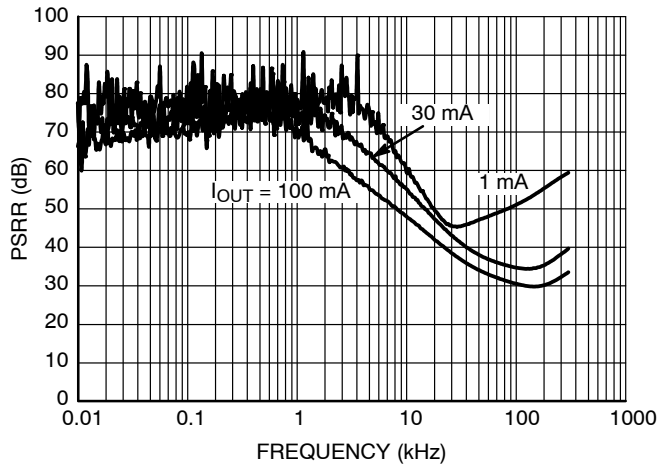

Figure 22. PSRR, 5.0 V Version,  $V_{IN} = 7.0 V$

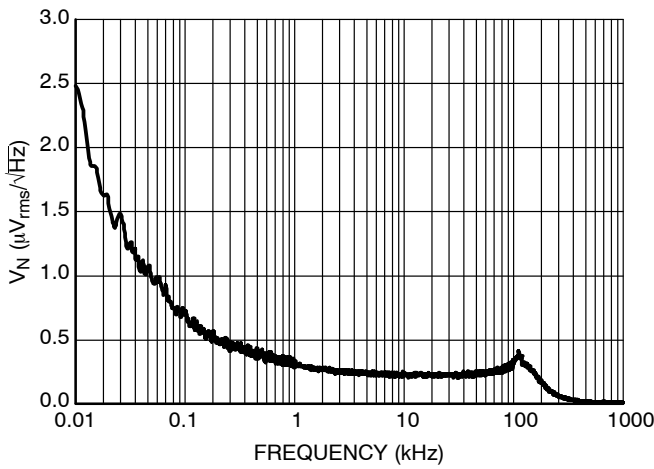

Figure 23. Output Voltage Noise, 1.2 V Version,  $V_{IN} = 2.6 V$

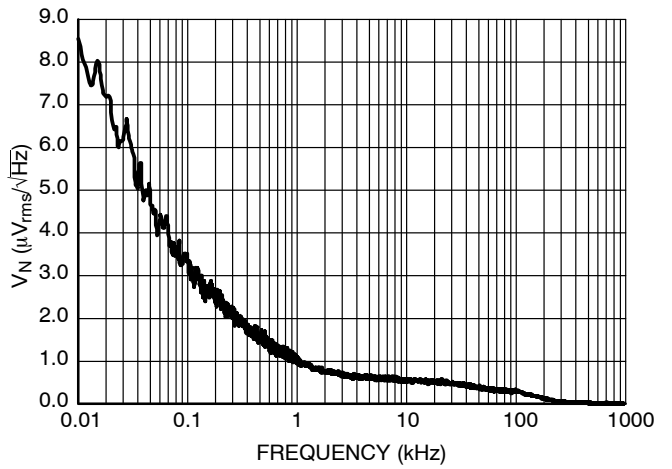

Figure 24. Output Voltage Noise, 2.8 V Version,  $V_{IN} = 3.8 V$

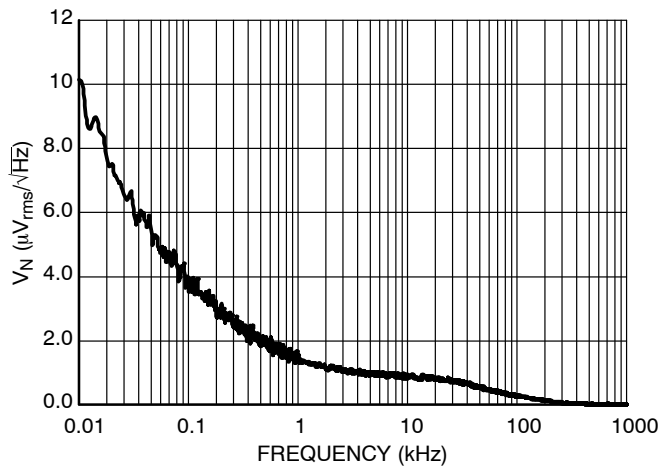
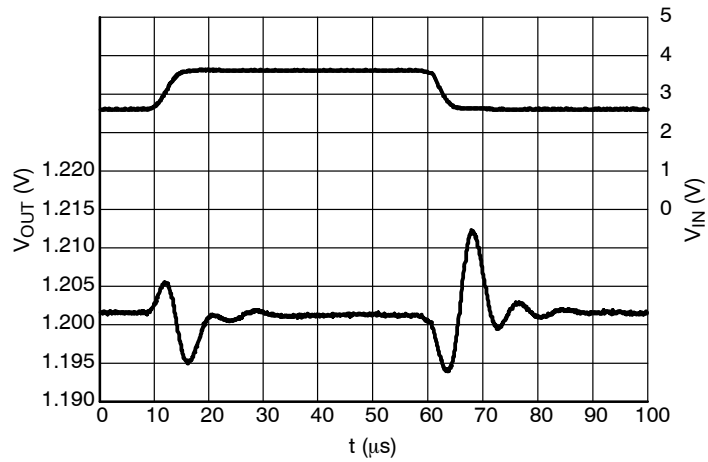

Figure 25. Output Voltage Noise, 5.0 V Version,  $V_{IN} = 6.0 V$

# NCP4625

## TYPICAL CHARACTERISTICS



**Figure 26. Line Transients, 1.2 V Version,  
 $t_R = t_F = 5 \mu\text{s}$ ,  $I_{OUT} = 30 \text{ mA}$**

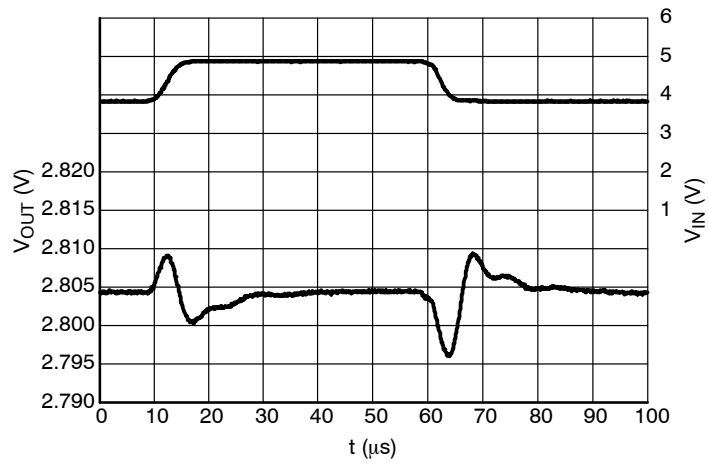

**Figure 27. Line Transients, 2.8 V Version,  
 $t_R = t_F = 5 \mu\text{s}$ ,  $I_{OUT} = 30 \text{ mA}$**

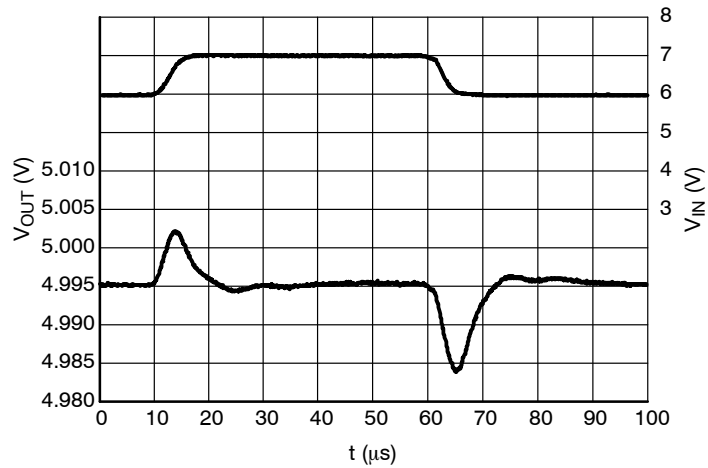

**Figure 28. Line Transients, 5.0 V Version,  
 $t_R = t_F = 5 \mu\text{s}$ ,  $I_{OUT} = 30 \text{ mA}$**

# NCP4625

## TYPICAL CHARACTERISTICS

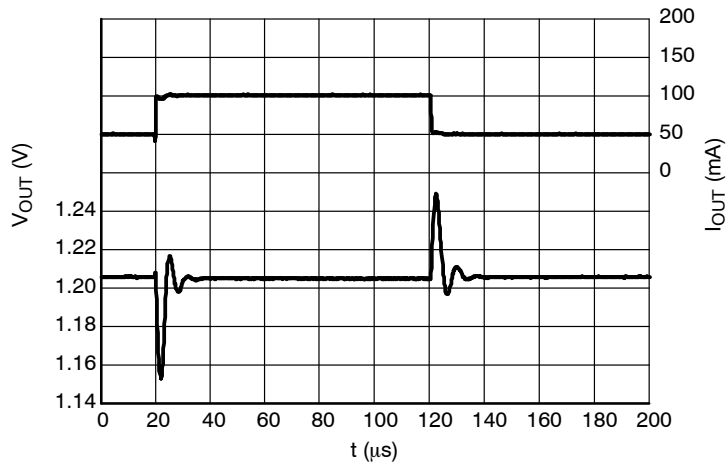

**Figure 29. Load Transients, 1.2 V Version,  
 $I_{OUT} = 50 - 100 \text{ mA}$ ,  $t_R = t_F = 0.5 \mu\text{s}$ ,  $V_{IN} = 2.6 \text{ V}$**

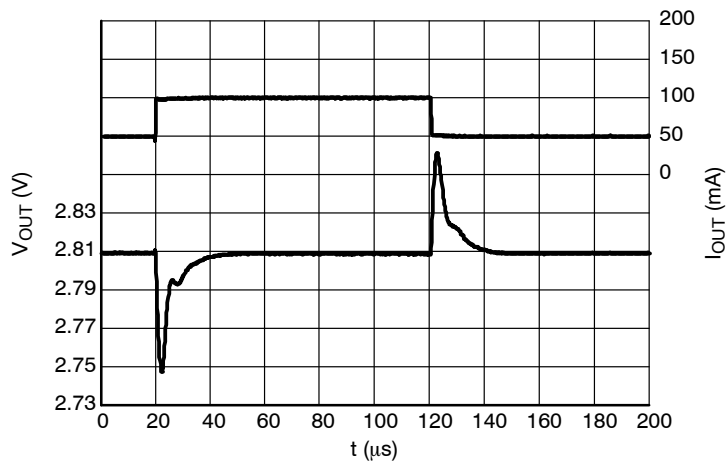

**Figure 30. Load Transients, 2.8 V Version,  
 $I_{OUT} = 50 - 100 \text{ mA}$ ,  $t_R = t_F = 0.5 \mu\text{s}$ ,  $V_{IN} = 3.8 \text{ V}$**

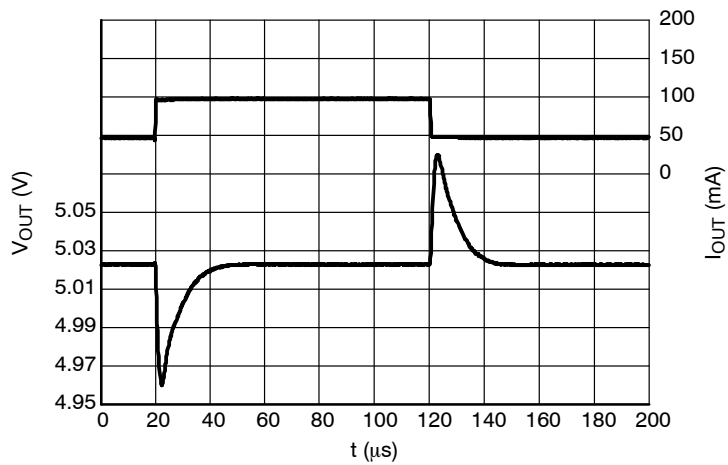

**Figure 31. Load Transients, 5.0 V Version,  
 $I_{OUT} = 50 - 100 \text{ mA}$ ,  $t_R = t_F = 0.5 \mu\text{s}$ ,  $V_{IN} = 6.0 \text{ V}$**

# NCP4625

## TYPICAL CHARACTERISTICS

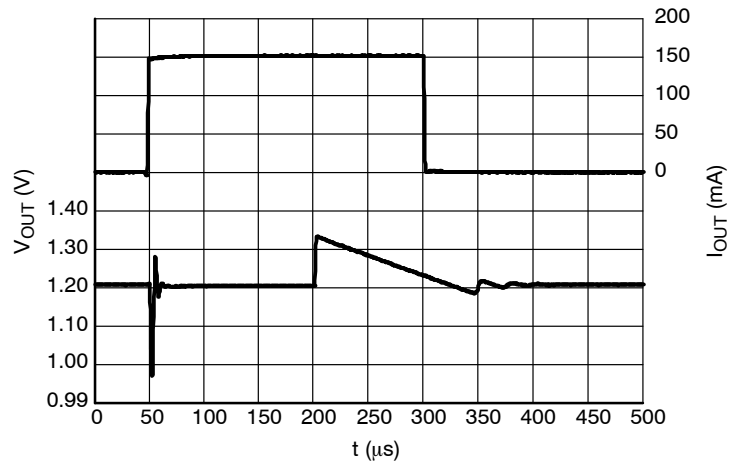

**Figure 32. Load Transients, 1.2 V Version,  
 $I_{OUT} = 1 - 150 \text{ mA}$ ,  $t_R = t_F = 0.5 \mu\text{s}$ ,  $V_{IN} = 2.6 \text{ V}$**

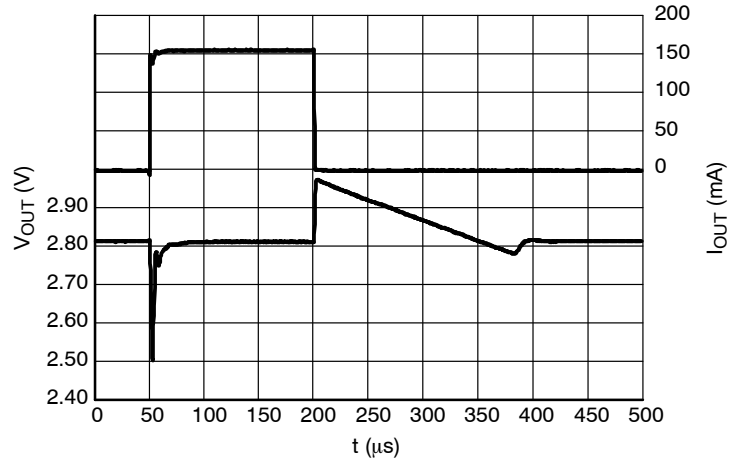

**Figure 33. Load Transients, 2.8 V Version,  
 $I_{OUT} = 1 - 150 \text{ mA}$ ,  $t_R = t_F = 0.5 \mu\text{s}$ ,  $V_{IN} = 3.8 \text{ V}$**

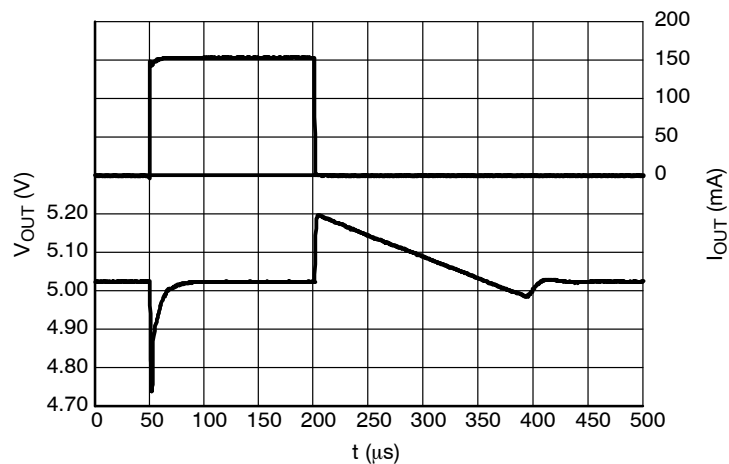

**Figure 34. Load Transients, 5.0 V Version,  
 $I_{OUT} = 1 - 150 \text{ mA}$ ,  $t_R = t_F = 0.5 \mu\text{s}$ ,  $V_{IN} = 6.0 \text{ V}$**

# NCP4625

## TYPICAL CHARACTERISTICS

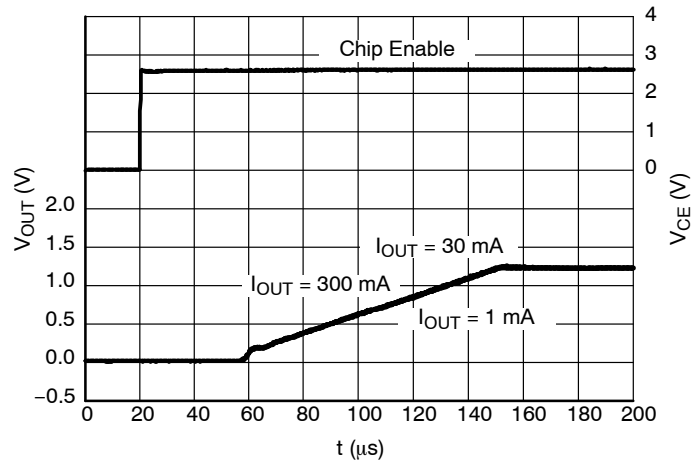

Figure 35. Start-up, 1.2 V Version,  $V_{\text{IN}} = 2.6 \text{ V}$

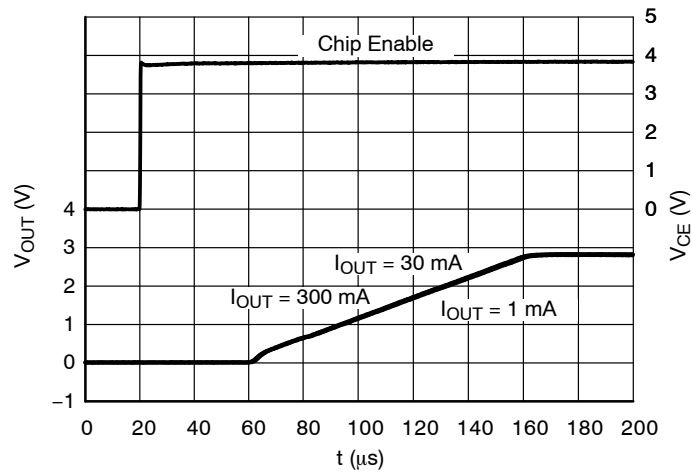

Figure 36. Start-up, 2.8 V Version,  $V_{\text{IN}} = 3.8 \text{ V}$

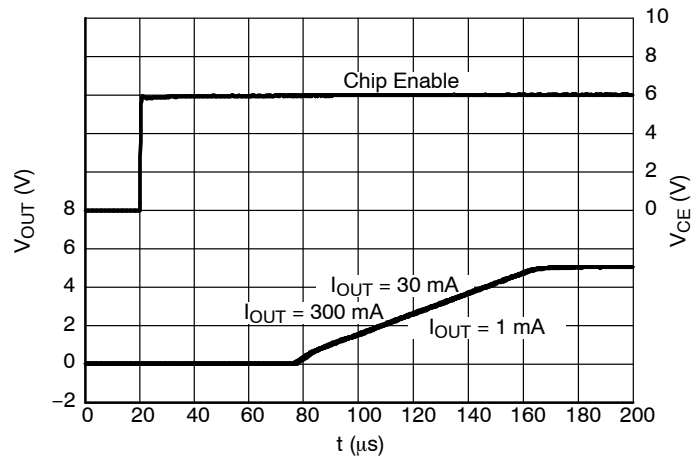

Figure 37. Start-up, 5.0 V Version,  $V_{\text{IN}} = 6.0 \text{ V}$

# NCP4625

## TYPICAL CHARACTERISTICS

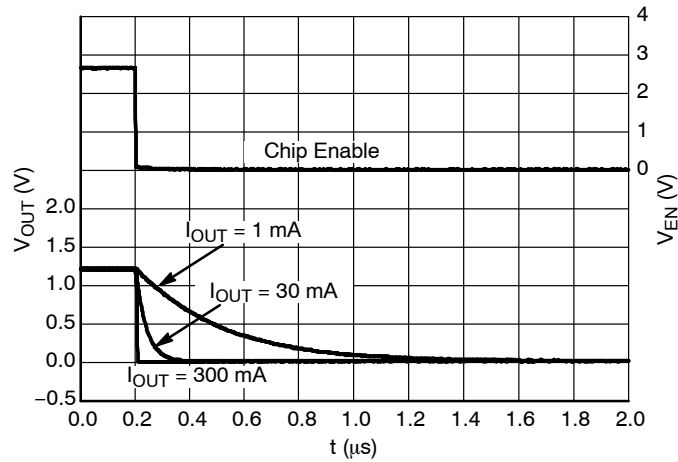

Figure 38. Shutdown, 1.2 V Version D,  
 $V_{IN} = 2.6 \text{ V}$

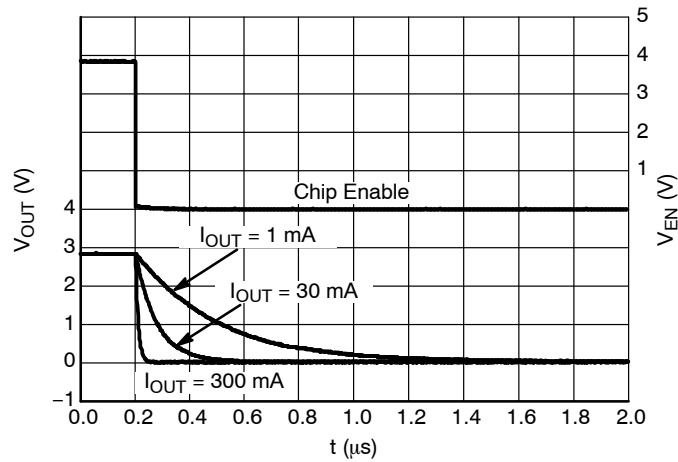

Figure 39. Shutdown, 2.8 V Version D,  
 $V_{IN} = 3.8 \text{ V}$

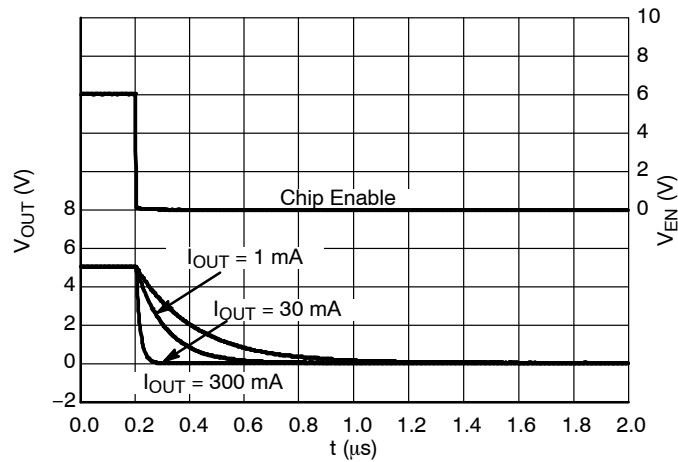

Figure 40. Shutdown, 5.0 V Version D,  
 $V_{IN} = 6.0 \text{ V}$

## APPLICATION INFORMATION

A typical application circuit for NCP4625 series is shown in Figure 41.

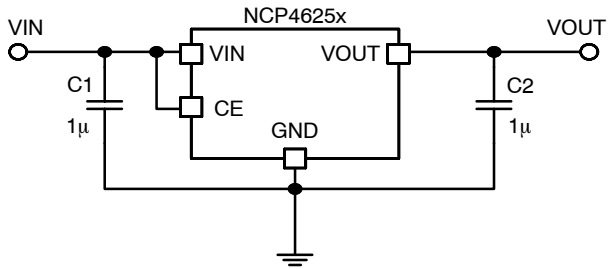

Figure 41. Typical Application Schematic

#### Input Decoupling Capacitor (C1)

A 1  $\mu\text{F}$  ceramic input decoupling capacitor should be connected as close as possible to the input and ground pin of the NCP4625. Higher values and lower ESR improves line transient response.

#### Output Decoupling Capacitor (C2)

A 1  $\mu\text{F}$  ceramic output decoupling capacitor is enough to achieve stable operation of the IC. If a tantalum capacitor is used, and its ESR is high, loop oscillation may result. The capacitors should be connected as close as possible to the output and ground pins. Larger values and lower ESR improves dynamic parameters.

#### Enable Operation

The enable pin CE may be used for turning the regulator on and off. The IC is switched on when a high level voltage is applied to the CE pin. The enable pin has an internal pull down current source. If the enable function is not needed connect CE pin to VIN.

#### Output Discharger

The D version includes a transistor between  $V_{\text{OUT}}$  and GND that is used for faster discharging of the output capacitor. This function is activated when the IC goes into disable mode.

#### Thermal

As a power across the IC increase, it might become necessary to provide some thermal relief. The maximum power dissipation supported by the device is dependent upon board design and layout. Mounting pad configuration on the PCB, the board material, and also the ambient temperature affect the rate of temperature increase for the part. When the device has good thermal conductivity through the PCB the junction temperature will be relatively low in high power dissipation applications.

#### PCB Layout

Make the VIN and GND line as large as practical. If their impedance is high, noise pickup or unstable operation may result. Connect capacitors C1 and C2 as close as possible to the IC, and make wiring as short as possible.

# NCP4625

## ORDERING INFORMATION

Device	Nominal Output Voltage	Description	Marking	Package	Shipping <sup>†</sup>
NCP4625DSN12T1G	1.2 V	Auto discharge	FBA	SOT-23 (Pb-Free)	3000 / Tape & Reel
NCP4625DSN18T1G	1.8 V	Auto discharge	FBH	SOT-23 (Pb-Free)	3000 / Tape & Reel
NCP4625DSN28T1G	2.8 V	Auto discharge	FBU	SOT-23 (Pb-Free)	3000 / Tape & Reel
NCP4625DSN30T1G	3.0 V	Auto discharge	FBX	SOT-23 (Pb-Free)	3000 / Tape & Reel
NCP4625DSN33T1G	3.3 V	Auto discharge	GBA	SOT-23 (Pb-Free)	3000 / Tape & Reel
NCP4625DSN50T1G	5.0 V	Auto discharge	GBT	SOT-23 (Pb-Free)	3000 / Tape & Reel
NCP4625HSN12T1G	1.2 V	Standard	FAA	SOT-23 (Pb-Free)	3000 / Tape & Reel
NCP4625HSN18T1G	1.8 V	Standard	FAH	SOT-23 (Pb-Free)	3000 / Tape & Reel
NCP4625HSN28T1G	2.8 V	Standard	FAU	SOT-23 (Pb-Free)	3000 / Tape & Reel
NCP4625HSN30T1G	3.0 V	Standard	FAX	SOT-23 (Pb-Free)	3000 / Tape & Reel
NCP4625HSN33T1G	3.3 V	Standard	GAA	SOT-23 (Pb-Free)	3000 / Tape & Reel
NCP4625HSN50T1G	5.0 V	Standard	GAT	SOT-23 (Pb-Free)	3000 / Tape & Reel

†For information on tape and reel specifications, including part orientation and tape sizes, please refer to our Tape and Reel Packaging Specifications Brochure, BRD8011/D.

# NCP4625

## PACKAGE DIMENSIONS

SC-88A (SC-70-5/SOT-353)

CASE 419A-02

ISSUE K

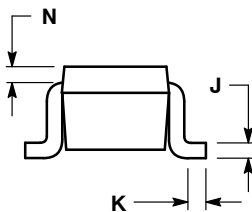
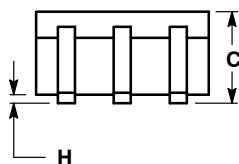
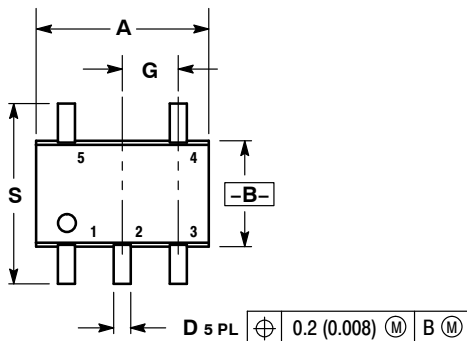

NOTES:

1. DIMENSIONING AND TOLERANCING PER ANSI Y14.5M, 1982.
2. CONTROLLING DIMENSION: INCH.
3. 419A-01 OBSOLETE. NEW STANDARD 419A-02.
4. DIMENSIONS A AND B DO NOT INCLUDE MOLD FLASH, PROTRUSIONS, OR GATE BURRS.

DIM	INCHES		MILLIMETERS	
	MIN	MAX	MIN	MAX
A	0.071	0.087	1.80	2.20
B	0.045	0.053	1.15	1.35
C	0.031	0.043	0.80	1.10
D	0.004	0.012	0.10	0.30
G	0.026 BSC		0.65 BSC	
H	---	0.004	---	0.10
J	0.004	0.010	0.10	0.25
K	0.004	0.012	0.10	0.30
N	0.008 REF		0.20 REF	
S	0.079	0.087	2.00	2.20

# NCP4625

## PACKAGE DIMENSIONS

SOT-89, 5 LEAD  
CASE 528AB-01  
ISSUE O

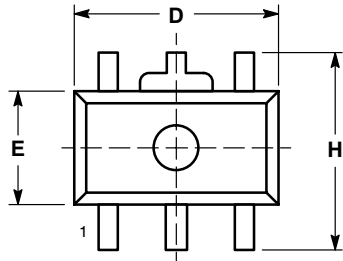

TOP VIEW

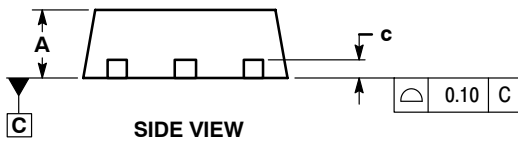

SIDE VIEW

NOTES:

1. DIMENSIONING AND TOLERANCING PER ASME Y14.5M, 1994.
2. CONTROLLING DIMENSION: MILLIMETERS.
3. LEAD THICKNESS INCLUDES LEAD FINISH.
4. DIMENSIONS D AND E DO NOT INCLUDE MOLD FLASH, PROTRUSIONS, OR GATE BURRS.
5. DIMENSIONS L, L2, L3, L4, L5, AND H ARE MEASURED AT DATUM PLANE C.

DIM	MILLIMETERS	
	MIN	MAX
A	1.40	1.60
b	0.32	0.52
b1	0.37	0.57
c	0.30	0.50
D	4.40	4.60
D2	1.40	1.80
E	2.40	2.60
e	1.40	1.60
H	4.25	4.45
L	1.10	1.50
L2	0.80	1.20
L3	0.95	1.35
L4	0.65	1.05
L5	0.20	0.60

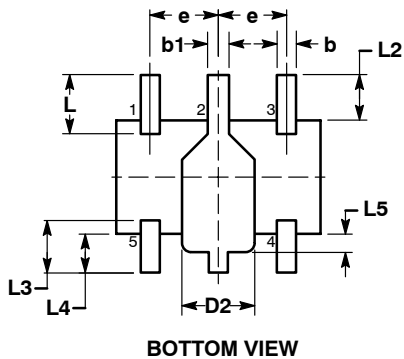

BOTTOM VIEW

### RECOMMENDED MOUNTING FOOTPRINT\*

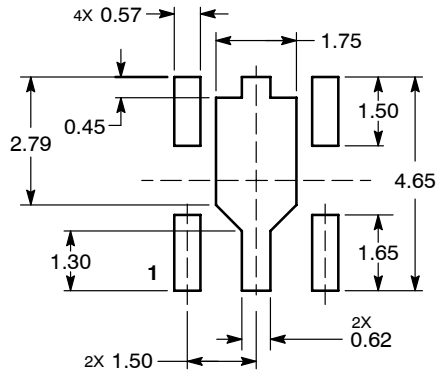

DIMENSIONS: MILLIMETERS

\*For additional information on our Pb-Free strategy and soldering details, please download the ON Semiconductor Soldering and Mounting Techniques Reference Manual, SOLDERRM/D.

# NCP4625

## PACKAGE DIMENSIONS

### SOT-23 5-LEAD CASE 1212-01 ISSUE A

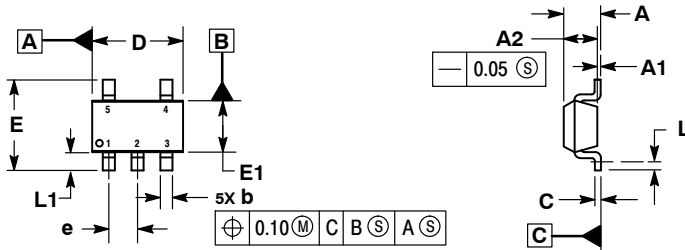

NOTES:

1. DIMENSIONING AND TOLERANCING PER ASME Y14.5M, 1994.
2. CONTROLLING DIMENSIONS: MILLIMETERS.
3. DATUM C IS THE SEATING PLANE.

MILLIMETERS		
DIM	MIN	MAX
A	---	1.45
A1	0.00	0.10
A2	1.00	1.30
b	0.30	0.50
c	0.10	0.25
D	2.70	3.10
E	2.50	3.10
E1	1.50	1.80
e	0.95 BSC	
L	0.20	---
L1	0.45	0.75

### RECOMMENDED SOLDERING FOOTPRINT\*

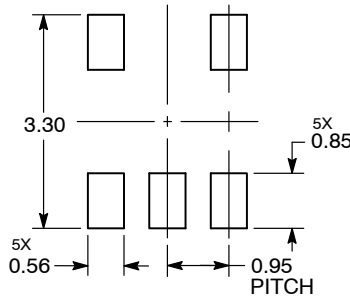

DIMENSIONS: MILLIMETERS

\*For additional information on our Pb-Free strategy and soldering details, please download the ON Semiconductor Soldering and Mounting Techniques Reference Manual, SOLDERRM/D.

ON Semiconductor and are registered trademarks of Semiconductor Components Industries, LLC (SCILLC). SCILLC reserves the right to make changes without further notice to any products herein. SCILLC makes no warranty, representation or guarantee regarding the suitability of its products for any particular purpose, nor does SCILLC assume any liability arising out of the application or use of any product or circuit, and specifically disclaims any and all liability, including without limitation special, consequential or incidental damages. "Typical" parameters which may be provided in SCILLC data sheets and/or specifications can and do vary in different applications and actual performance may vary over time. All operating parameters, including "Typicals" must be validated for each customer application by customer's technical experts. SCILLC does not convey any license under its patent rights nor the rights of others. SCILLC products are not designed, intended, or authorized for use as components in systems intended for surgical implant into the body, or other applications intended to support or sustain life, or for any other application in which the failure of the SCILLC product could create a situation where personal injury or death may occur. Should Buyer purchase or use SCILLC products for any such unintended or unauthorized application, Buyer shall indemnify and hold SCILLC and its officers, employees, subsidiaries, affiliates, and distributors harmless against all claims, costs, damages, and expenses, and reasonable attorney fees arising out of, directly or indirectly, any claim of personal injury or death associated with such unintended or unauthorized use, even if such claim alleges that SCILLC was negligent regarding the design or manufacture of the part. SCILLC is an Equal Opportunity/Affirmative Action Employer. This literature is subject to all applicable copyright laws and is not for resale in any manner.

### PUBLICATION ORDERING INFORMATION

**LITERATURE FULFILLMENT:**  
Literature Distribution Center for ON Semiconductor  
P.O. Box 5163, Denver, Colorado 80217 USA  
**Phone:** 303-675-2175 or 800-344-3860 Toll Free USA/Canada  
**Fax:** 303-675-2176 or 800-344-3867 Toll Free USA/Canada  
**Email:** orderlit@onsemi.com

**N. American Technical Support:** 800-282-9855 Toll Free  
USA/Canada  
**Europe, Middle East and Africa Technical Support:**  
Phone: 421 33 790 2910  
**Japan Customer Focus Center**  
Phone: 81-3-5817-1050

**ON Semiconductor Website:** [www.onsemi.com](http://www.onsemi.com)  
**Order Literature:** <http://www.onsemi.com/orderlit>

For additional information, please contact your local Sales Representative

## Looking for pricing, stock, or lifecycle information?

Click below to explore more details on WIN SOURCE:

- ⊖ [View NCP4625DSN18T1G on WIN SOURCE](#)
- ⊖ [ON Semiconductor Information](#)

## Optimize Your Supply Chain with WIN SOURCE Solutions

- ✓ Global Sourcing Solution
- ✓ Obsolete Management
- ✓ Cost Control Management
- ✓ Shortage Management
- ✓ Alternative Solution
- ✓ Excess Inventory Management