

500 mA Low Dropout Regulator

Features

- Guaranteed 500 mA Output Over the Full Operating Temperature Range
- Low 300 mV Typical Dropout Voltage at Full Load
- Extremely Tight Load and Line Regulation
- Current and Thermal Limiting
- Reversed-Battery Protection
- TO-220 and TO-263 Packages
- Low Temperature Coefficient
- No-Load Stability
- Low Noise Output

Applications

- Portable and Laptop Computers
- Desktop Computer
- Battery Chargers
- SMPS Post-Regulator and DC/DC Modules
- Consumer and Personal Electronics

General Description

The MIC5237 is a general-purpose low-dropout regulator capable of 500 mA output current with better than 3% output voltage accuracy. Using Microchip's proprietary Super β PNP process with a PNP pass element, these regulators feature less than 300 mV dropout voltage and typically 8 mA ground current at full load.

Designed for applications that require moderate current over a broad input voltage range, including hand-held and battery-powered devices, the MIC5237 is intended for applications that can tolerate moderate voltage drop at higher current.

Key features include low ground current to help prolong battery life, reversed-battery protection, current limiting, overtemperature shutdown, and thermally efficient packaging. The MIC5237 is available in fixed output voltages only.

For space-critical applications and improved performance, see the MIC5209 and MIC5219. For output current requirements up to 750 mA, see the MIC2937.

Package Types

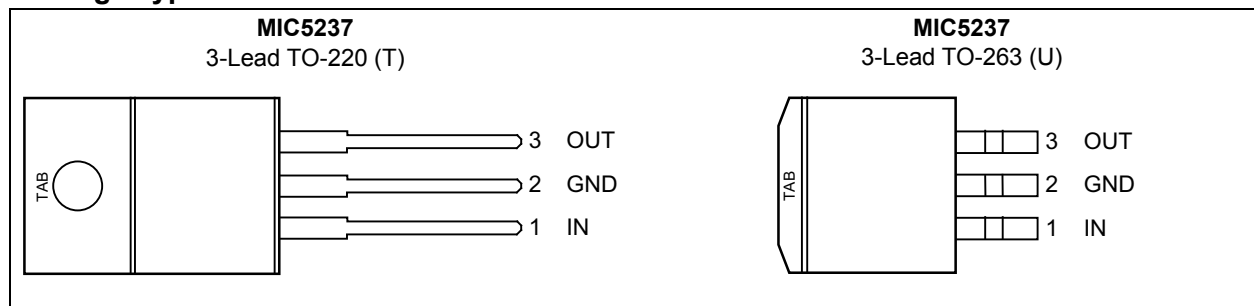

MIC5237

Typical Application Circuit

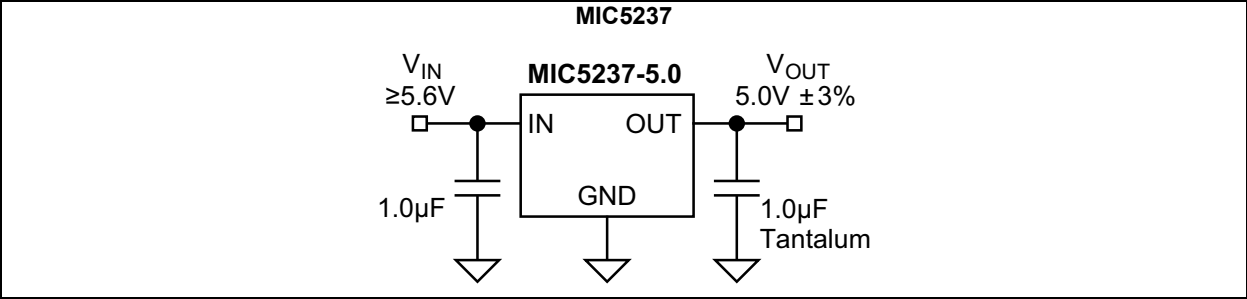

Functional Block Diagrams

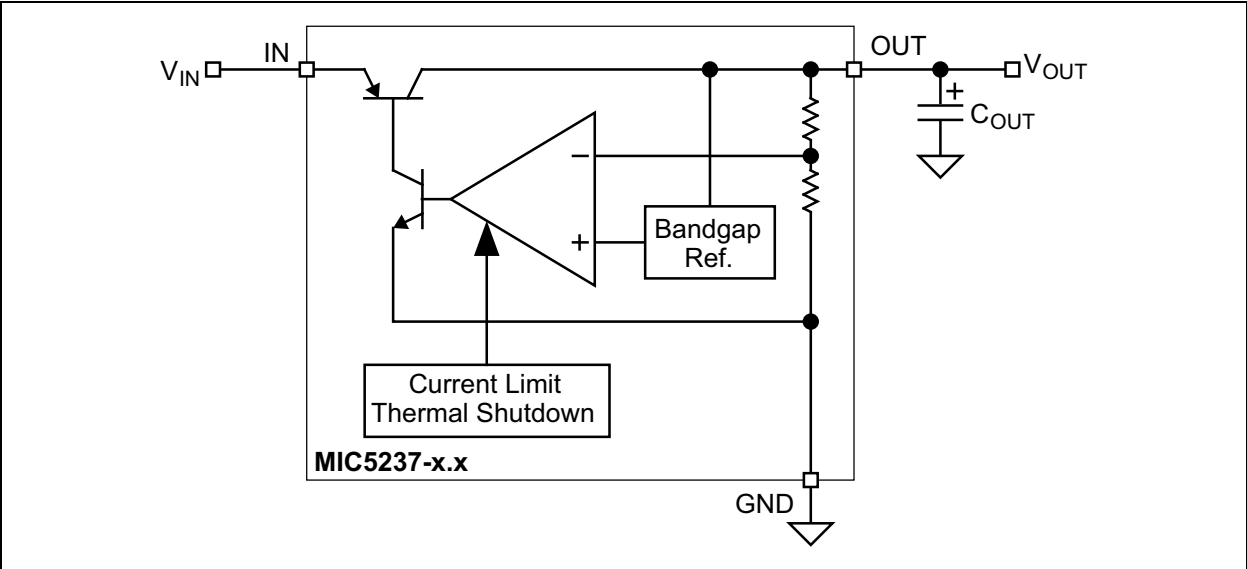

1.0 ELECTRICAL CHARACTERISTICS

Absolute Maximum Ratings †

Supply Input Voltage (V_{IN}) –20V to +20V
 Power Dissipation (P_D) (Note 1) Internally Limited

Operating Ratings ‡

Supply Input Voltage (V_{IN}) +2.5V to +16V

† **Notice:** Stresses above those listed under “Absolute Maximum Ratings” may cause permanent damage to the device. This is a stress rating only and functional operation of the device at those or any other conditions above those indicated in the operational sections of this specification is not intended. Exposure to maximum rating conditions for extended periods may affect device reliability.

‡ **Notice:** The device is not guaranteed to function outside its operating ratings.

Note 1: The maximum allowable power dissipation at any T_A (ambient temperature) is calculated using: $P_{D(max)} = (T_{J(max)} - T_A) \div \theta_{JA}$. Exceeding the maximum allowable power dissipation will result in excessive die temperature, and the regulator will go into thermal shutdown.

TABLE 1-1: ELECTRICAL CHARACTERISTICS

Electrical Characteristics: $V_{IN} = V_{OUT} + 1.0V$; $C_{OUT} = 4.7 \mu F$; $I_{OUT} = 100 \mu A$; $T_J = +25^\circ C$, **bold** values indicate $-40^\circ C \leq T_J \leq +125^\circ C$; unless noted.

Parameter	Symbol	Min.	Typ.	Max.	Units	Conditions
Output Voltage Accuracy	V_{OUT}	–3	—	3	%	Variation from nominal V_{OUT} .
		–5	—	5		
Output Voltage Temperature Coefficient	$\Delta V_{OUT}/\Delta T$	—	40	—	ppm/°C	Note 1
Line Regulation	$\Delta V_{OUT}/V_{OUT}$	—	—	0.05	%/V	$V_{IN} = V_{OUT} + 1V$ to 16V
		—	0.015	0.1		
Load Regulation	$\Delta V_{OUT}/V_{OUT}$	—	0.05	0.5	%	$I_{OUT} = 100 \mu A$ to 500 mA, Note 2
		—	—	0.7		
Dropout Voltage, Note 3	$V_{IN} - V_{OUT}$	—	10	70	mV	$I_{OUT} = 100 \mu A$
		—	—	90	mV	
		—	115	190	mV	$I_{OUT} = 50 mA$
		—	—	280	mV	
		—	165	350	mV	$I_{OUT} = 150 mA$
		—	—	450	mV	
		—	300	600	mV	$I_{OUT} = 500 mA$
—	—	700	mV			
Ground Pin Current, Note 4	I_{GND}	—	80	130	μA	$I_{OUT} = 100 \mu A$
		—	—	170	μA	
		—	350	650	μA	$I_{OUT} = 50 mA$
		—	—	900	μA	
		—	1.8	2.5	mA	$I_{OUT} = 150 mA$
		—	—	3.0	mA	
		—	8	15	mA	$I_{OUT} = 500 mA$
—	—	20	mA			
Ripple Rejection	PSRR	—	75	—	dB	f = 120 Hz

MIC5237

TABLE 1-1: ELECTRICAL CHARACTERISTICS (CONTINUED)

Electrical Characteristics: $V_{IN} = V_{OUT} + 1.0V$; $C_{OUT} = 4.7 \mu F$; $I_{OUT} = 100 \mu A$; $T_J = +25^\circ C$, **bold** values indicate $-40^\circ C \leq T_J \leq +125^\circ C$; unless noted.

Parameter	Symbol	Min.	Typ.	Max.	Units	Conditions
Current Limit	I_{LIMIT}	—	700	900	mA	$V_{OUT} = 0V$
		—	—	1000		
Thermal Regulation	$\frac{\Delta V_{OUT}}{\Delta P_D}$	—	0.05	—	%/W	Note 5
Output Noise	e_{no}	—	500	—	nV/ \sqrt{Hz}	$V_{OUT} = 5.0V$, $I_{OUT} = 50 mA$, $C_{OUT} = 2.2 \mu F$

- Note 1:** Output voltage temperature coefficient is defined as the worst case voltage change divided by the total temperature range.
- 2:** Regulation is measured at constant junction temperature using low duty cycle pulse testing. Parts are tested for load regulation in the load range from 100 μA to 500 mA. Changes in output voltage due to heating effects are covered by the thermal regulation specification.
- 3:** Dropout voltage is defined as the input to output differential at which the output voltage drops 2% below its nominal value measured at 1V differential.
- 4:** Ground pin current is the regulator quiescent current plus pass transistor base current. The total current drawn from the supply is the sum of the load current plus the ground pin current.
- 5:** Thermal regulation is defined as the change in output voltage at a time “t” after a change in power dissipation is applied, excluding load or line regulation effects. Specifications are for a 500 mA load pulse at $V_{IN} = 16V$ for $t = 10 ms$.

TEMPERATURE SPECIFICATIONS (Note 1)

Parameters	Sym.	Min.	Typ.	Max.	Units	Conditions
Temperature Ranges						
Junction Operating Temperature Range	T_J	-40	—	+125	°C	—
Lead Temperature	—	—	—	+260	°C	Soldering, 5s
Package Thermal Resistances						
Thermal Resistance TO-263	θ_{JC}	—	3	—	°C/W	—
Thermal Resistance TO-220	θ_{JC}	—	3	—	°C/W	—
	θ_{JA}	—	55	—	°C/W	—

Note 1: The maximum allowable power dissipation is a function of ambient temperature, the maximum allowable junction temperature and the thermal resistance from junction to air (i.e., T_A , T_J , θ_{JA}). Exceeding the maximum allowable power dissipation will cause the device operating junction temperature to exceed the maximum +125°C rating. Sustained junction temperatures above +125°C can impact the device reliability.

MIC5237

2.0 TYPICAL PERFORMANCE CURVES

Note: The graphs and tables provided following this note are a statistical summary based on a limited number of samples and are provided for informational purposes only. The performance characteristics listed herein are not tested or guaranteed. In some graphs or tables, the data presented may be outside the specified operating range (e.g., outside specified power supply range) and therefore outside the warranted range.

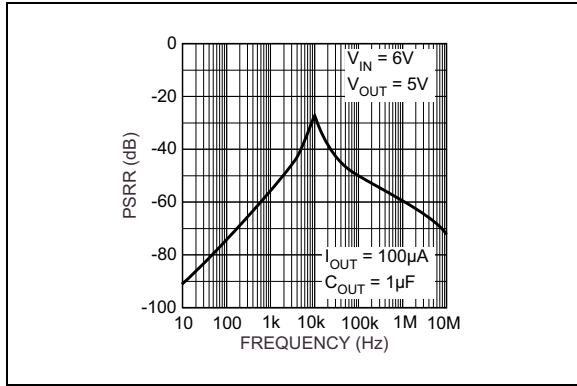

FIGURE 2-1: Power Supply Rejection Ratio.

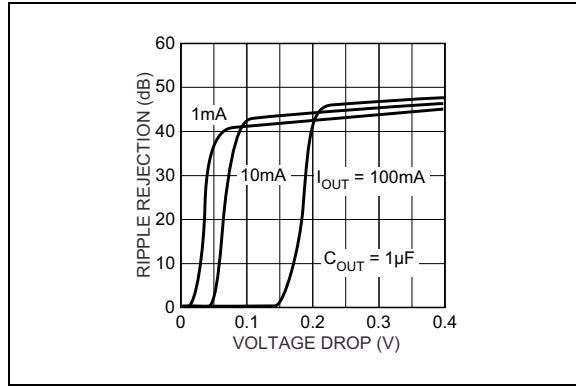

FIGURE 2-4: Power Supply Ripple Rejection vs. Voltage Drop.

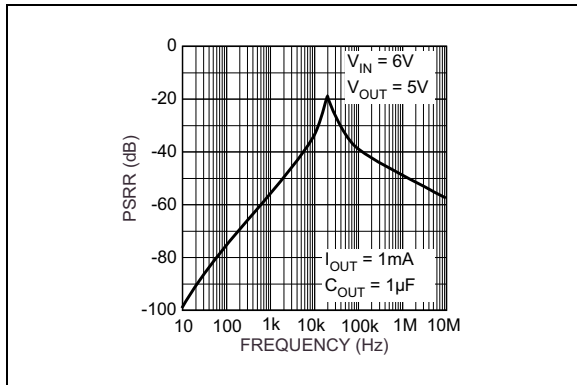

FIGURE 2-2: Power Supply Rejection Ratio.

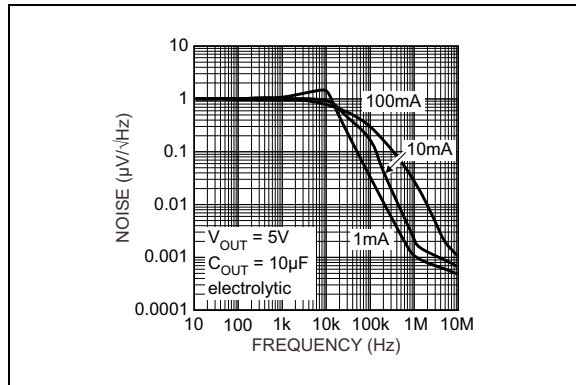

FIGURE 2-5: Noise Performance.

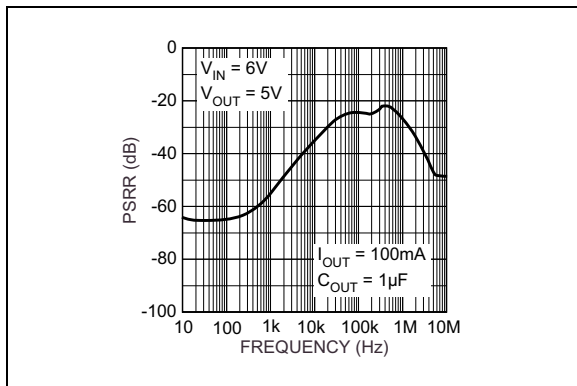

FIGURE 2-3: Power Supply Rejection Ratio.

3.0 PIN DESCRIPTIONS

The descriptions of the pins are listed in [Table 3-1](#).

TABLE 3-1: PIN FUNCTION TABLE

Pin Number	Pin Name	Description
1	IN	Supply input.
2, TAB	GND	Ground: TO-220 and TO-263 pin 2 and TAB are internally connected.
3	OUT	Regulator output.

MIC5237

4.0 APPLICATION INFORMATION

The MIC5237 is intended for general purpose use and can be implemented in a wide variety of applications where 500 mA of output current is needed. It is available in several voltage options for ease-of-use. For voltage options that are not available on the MIC5237, consult the MIC5209 for a 500 mA adjustable LDO regulator, or the MIC5219 for applications that require only short-duration peak output current.

4.1 Input Capacitor

A 1 μF capacitor should be placed from IN to GND if there is more than 10 inches of wire between the input and the ac filter capacitor or if a battery is used as the input.

4.2 Output Capacitor

An output capacitor is required between OUT and GND to prevent oscillation. 1 μF minimum is recommended for standard applications. Larger values improve the regulator's transient response. The output capacitor value may be increased without limit.

The output capacitor should have an ESR (equivalent series resistance) of about 5 Ω or less and a resonant frequency above 1 MHz. Ultra low-ESR capacitors can cause low-amplitude oscillations and/or under-damped transient response. Most tantalum or aluminum electrolytic capacitors are adequate; film types will work, but are more expensive. Because many aluminum electrolytics have electrolytes that freeze at about -30°C , solid tantalums are recommended for operation below -25°C .

At lower values of output current, less output capacitance is needed for output stability. The capacitor can be reduced to 0.47 μF for current below 10 mA or 0.33 μF for currents below 1 mA.

For 2.5V applications a 22 μF output capacitor is recommended to reduce startup voltage overshoot.

4.3 No-Load Stability

The MIC5237 will remain stable and in regulation with no load (other than the internal voltage divider) unlike many other voltage regulators. This is especially important in CMOS RAM keep-alive applications.

4.4 Thermal Considerations

Proper thermal design can be accomplished with some basic design criteria and some simple equations. The following information is required to implement a regulator design.

- V_{IN} = Input Voltage
- V_{OUT} = Output Voltage
- I_{OUT} = Output Current

- T_A = Ambient Operating Temperature
- I_{GND} = Ground Current

The regulator ground current, I_{GND} , can be measured or read from the data sheet. Assuming the worst case scenario is good design procedure, and the corresponding ground current number can be obtained from the data sheet. First, calculate the power dissipation of the device. This example uses the MIC5237-5.0YT, a 13V input, and 500 mA output current, which results in 20 mA of ground current, worst case. The power dissipation is the sum of two power calculations: voltage drop \times output current and input voltage \times ground current.

EQUATION 4-1:

$$P_D = [(V_{IN} - V_{OUT}) \times I_{OUT}] + (V_{IN} \times I_{GND})$$

EQUATION 4-2:

$$P_D = [(13V - 5V) \times 500mA] + (13V \times 20mA) \\ = 4.260W$$

From this number, the heat sink thermal resistance is determined using the regulator's maximum operating junction temperature ($T_{J(max)}$) and the ambient temperature (T_A) along with the power dissipation number already calculated.

- T_{JMAX} = 125 $^{\circ}\text{C}$
- θ_{JC} = Junction-to-Case Thermal Resistance
- θ_{CS} = Case-to-Sink Thermal Resistance
- θ_{JA} = Junction-to-Ambient Thermal Resistance
- θ_{SA} = Sink-to-Ambient Thermal Resistance

To determine the heat sink thermal resistance, the junction-to-case thermal resistance of the device must be used along with the case-to-heat sink thermal resistance. These numbers show the heat sink thermal resistance required at $T_A = 25^{\circ}\text{C}$ that does not exceed the maximum operating junction temperature.

EQUATION 4-3:

$$\theta_{JA} = \frac{T_{J(MAX)} - T_A}{P_D}$$

EQUATION 4-4:

$$\theta_{SA} = \theta_{JA} - \theta_{JC}$$

θ_{CS} is approximately $1^{\circ}\text{C}/\text{W}$ and θ_{JC} for the TO-220 is $3^{\circ}\text{C}/\text{W}$ in this example.

EQUATION 4-5:

$$\theta_{JA} = \frac{125^{\circ}\text{C} - 25^{\circ}\text{C}}{4.260\text{W}} = 23.5^{\circ}\text{C}/\text{W}$$

EQUATION 4-6:

$$\theta_{SA} = 23.5^{\circ}\text{C}/\text{W} - (3^{\circ}\text{C}/\text{W} + 1^{\circ}\text{C}/\text{W}) = 19.5^{\circ}\text{C}/\text{W}$$

Therefore, a heat sink with a thermal resistance of $19.5^{\circ}\text{C}/\text{W}$ will allow the part to operate safely and it will not exceed the maximum junction temperature of the device. The heat sink can be reduced by limiting power dissipation, by reducing the input voltage or output current. Either the TO-220 or TO-263 package can operate reliably at 2W of power dissipation without a heat sink. Above 2W, a heat sink is recommended.

MIC5237

5.0 PACKAGING INFORMATION

5.1 Package Marking Information

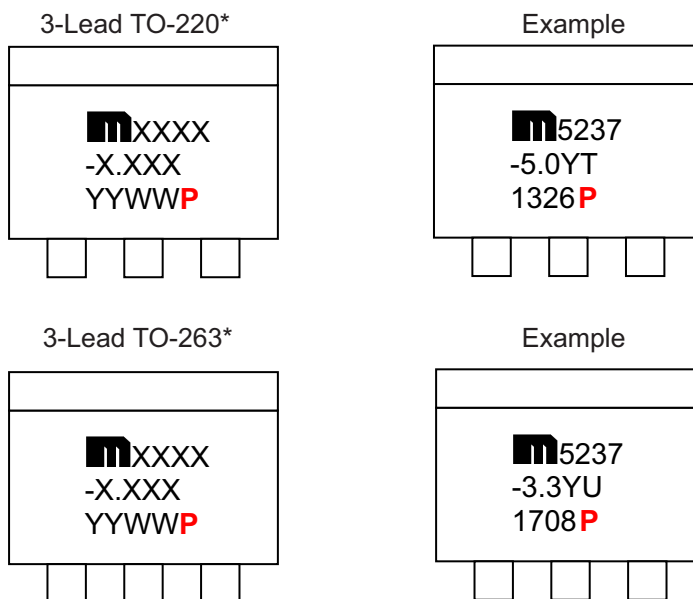

Legend:	XX...X	Product code or customer-specific information
	Y	Year code (last digit of calendar year)
	YY	Year code (last 2 digits of calendar year)
	WW	Week code (week of January 1 is week '01')
	NNN	Alphanumeric traceability code
	(e3)	Pb-free JEDEC® designator for Matte Tin (Sn)
	*	This package is Pb-free. The Pb-free JEDEC designator ((e3)) can be found on the outer packaging for this package.
	•, ▲, ▼	Pin one index is identified by a dot, delta up, or delta down (triangle mark).
Note:	In the event the full Microchip part number cannot be marked on one line, it will be carried over to the next line, thus limiting the number of available characters for customer-specific information. Package may or may not include the corporate logo.	
	Underbar (¯) and/or Overbar (¯) symbol may not be to scale.	

3-Lead TO-220 Package Outline and Recommended Land Pattern

TITLE

3 LEAD TO220 PACKAGE OUTLINE & RECOMMENDED LAND PATTERN

DRAWING #	TO220-3LD-PL-1	UNIT	INCH
Lead Frame	Copper Alloy	Lead Finish	Matte Tin

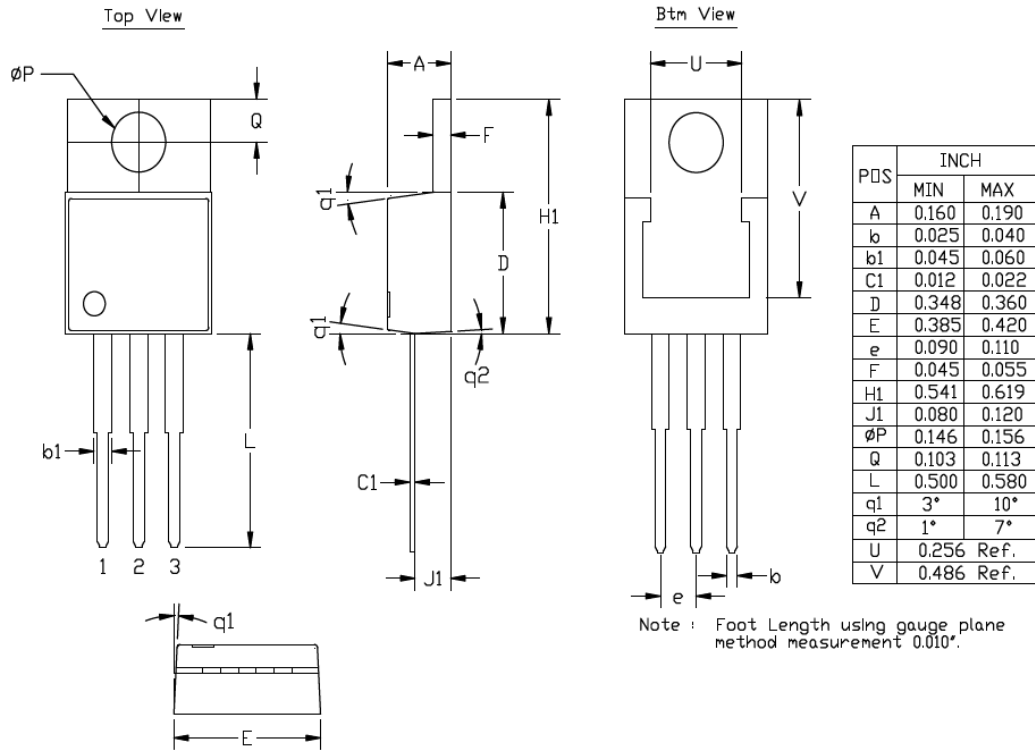

Note: For the most current package drawings, please see the Microchip Packaging Specification located at <http://www.microchip.com/packaging>.

MIC5237

3-Lead TO-263 Package Outline and Recommended Land Pattern

TITLE

3 LEAD TO263 PACKAGE OUTLINE & RECOMMENDED LAND PATTERN

DRAWING #	TO263-3LD-PL-1	UNIT	INCH/MM
------------------	----------------	-------------	---------

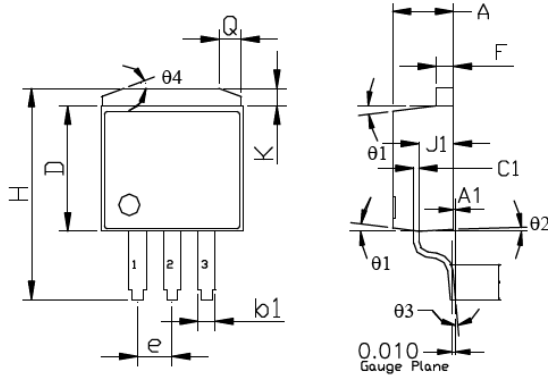

TOP VIEW

SIDE VIEW 1

POS	INCH		MM	
	MIN	MAX	MIN	MAX
A	0.170	0.181	4.318	4.597
A1	0.000	0.012	0.000	0.305
b1	0.047	0.053	1.194	1.346
C1	0.012	0.023	0.305	0.584
D	0.330	0.361	8.382	9.169
E	0.396	0.420	10.058	10.668
e	0.095	0.105	2.413	2.667
F	0.045	0.055	1.143	1.397
H	0.575	0.625	14.605	15.875
J1	0.080	0.120	2.032	3.048
L1	0.090	0.110	2.286	2.794
K	0.045	0.066	1.143	1.676
theta1	3°	10°	3°	10°
theta2	1°	7°	1°	7°
theta3	0°	8°	0°	8°
theta4	18°	22°	18°	22°
Q	0.055	0.075	1.397	1.905
U	0.256	Ref.	6.502	Ref.
V	0.303	Ref.	7.696	Ref.

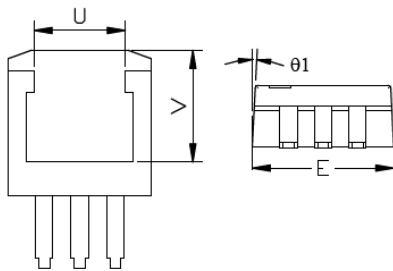

BOTTOM VIEW

SIDE VIEW 2

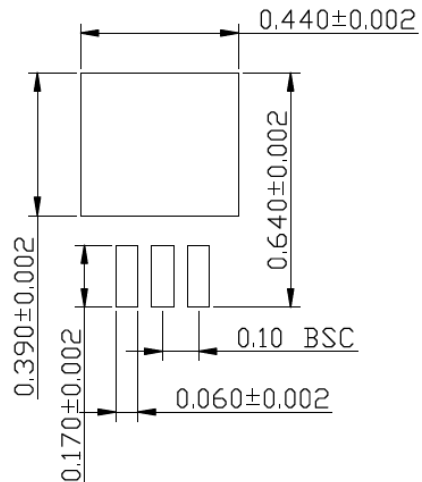

RECOMMENDED LAND PATTERN (UNIT: INCH)

NOTES:
FOOT LENGTH USE GAUGE PLANE METHOD MEASUREMENT 0.010"

Note: For the most current package drawings, please see the Microchip Packaging Specification located at <http://www.microchip.com/packaging>.

APPENDIX A: REVISION HISTORY

Revision A (October 2018)

- Converted Micrel document MIC5237 to Microchip data sheet DS20006095A.
- Minor text changes throughout.

MIC5237

NOTES:

PRODUCT IDENTIFICATION SYSTEM

To order or obtain information, e.g., on pricing or delivery, contact your local Microchip representative or sales office.

<u>PART NO.</u>	<u>-X.X</u>	<u>X</u>	<u>XX</u>	<u>-XX</u>																																													
Device	Voltage	Temperature	Package	Media Type																																													
<table border="1" style="width: 100%;"> <tr> <td style="width: 15%;">Device:</td> <td>MIC5237:</td> <td colspan="3">500 mA Low Dropout Regulator</td> </tr> <tr> <td>Voltage:</td> <td>2.5 =</td> <td colspan="3">2.5V (TO-263 Only)</td> </tr> <tr> <td></td> <td>3.3 =</td> <td colspan="3">3.3V (TO-263 Only)</td> </tr> <tr> <td></td> <td>5.0 =</td> <td colspan="3">5.0V (Both Packages)</td> </tr> <tr> <td>Temperature:</td> <td>Y =</td> <td colspan="3">-40°C to +125°C</td> </tr> <tr> <td>Package:</td> <td>T =</td> <td colspan="3">3-Lead TO-220</td> </tr> <tr> <td></td> <td>U =</td> <td colspan="3">3-Lead TO-263</td> </tr> <tr> <td>Media Type:</td> <td><blank>=</td> <td colspan="3">50/Tube (Both Packages)</td> </tr> <tr> <td></td> <td>TR =</td> <td colspan="3">750/Reel (TO-263 Only)</td> </tr> </table>					Device:	MIC5237:	500 mA Low Dropout Regulator			Voltage:	2.5 =	2.5V (TO-263 Only)				3.3 =	3.3V (TO-263 Only)				5.0 =	5.0V (Both Packages)			Temperature:	Y =	-40°C to +125°C			Package:	T =	3-Lead TO-220				U =	3-Lead TO-263			Media Type:	<blank>=	50/Tube (Both Packages)				TR =	750/Reel (TO-263 Only)		
Device:	MIC5237:	500 mA Low Dropout Regulator																																															
Voltage:	2.5 =	2.5V (TO-263 Only)																																															
	3.3 =	3.3V (TO-263 Only)																																															
	5.0 =	5.0V (Both Packages)																																															
Temperature:	Y =	-40°C to +125°C																																															
Package:	T =	3-Lead TO-220																																															
	U =	3-Lead TO-263																																															
Media Type:	<blank>=	50/Tube (Both Packages)																																															
	TR =	750/Reel (TO-263 Only)																																															
<p>Examples:</p> <p>a) MIC5237-2.5YU: 500 mA Low Dropout Regulator 2.5V, -40°C to +125°C, 3-Lead TO-263, 50/Tube</p> <p>b) MIC5237-2.5YU-TR: 500 mA Low Dropout Regulator 2.5V, -40°C to +125°C, 3-Lead TO-263, 750/Reel</p> <p>c) MIC5237-3.3YU: 500 mA Low Dropout Regulator 3.3V, -40°C to +125°C, 3-Lead TO-263, 50/Tube</p> <p>d) MIC5237-3.3YU-TR: 500 mA Low Dropout Regulator 3.3V, -40°C to +125°C, 3-Lead TO-263, 750/Reel</p> <p>e) MIC5237-5.0YU: 500 mA Low Dropout Regulator 5.0V, -40°C to +125°C, 3-Lead TO-263, 50/Tube</p> <p>f) MIC5237-5.0YU-TR: 500 mA Low Dropout Regulator 5.0V, -40°C to +125°C, 3-Lead TO-263, 750/Reel</p> <p>g) MIC5237-5.0YT: 500 mA Low Dropout Regulator 5.0V, -40°C to +125°C, 3-Lead TO-220, 50/Tube</p> <p>Note 1: Tape and Reel identifier only appears in the catalog part number description. This identifier is used for ordering purposes and is not printed on the device package. Check with your Microchip Sales Office for package availability with the Tape and Reel option.</p>																																																	

MIC5237

NOTES:

Note the following details of the code protection feature on Microchip devices:

- Microchip products meet the specification contained in their particular Microchip Data Sheet.
- Microchip believes that its family of products is one of the most secure families of its kind on the market today, when used in the intended manner and under normal conditions.
- There are dishonest and possibly illegal methods used to breach the code protection feature. All of these methods, to our knowledge, require using the Microchip products in a manner outside the operating specifications contained in Microchip's Data Sheets. Most likely, the person doing so is engaged in theft of intellectual property.
- Microchip is willing to work with the customer who is concerned about the integrity of their code.
- Neither Microchip nor any other semiconductor manufacturer can guarantee the security of their code. Code protection does not mean that we are guaranteeing the product as “unbreakable.”

Code protection is constantly evolving. We at Microchip are committed to continuously improving the code protection features of our products. Attempts to break Microchip's code protection feature may be a violation of the Digital Millennium Copyright Act. If such acts allow unauthorized access to your software or other copyrighted work, you may have a right to sue for relief under that Act.

Information contained in this publication regarding device applications and the like is provided only for your convenience and may be superseded by updates. It is your responsibility to ensure that your application meets with your specifications. MICROCHIP MAKES NO REPRESENTATIONS OR WARRANTIES OF ANY KIND WHETHER EXPRESS OR IMPLIED, WRITTEN OR ORAL, STATUTORY OR OTHERWISE, RELATED TO THE INFORMATION, INCLUDING BUT NOT LIMITED TO ITS CONDITION, QUALITY, PERFORMANCE, MERCHANTABILITY OR FITNESS FOR PURPOSE. Microchip disclaims all liability arising from this information and its use. Use of Microchip devices in life support and/or safety applications is entirely at the buyer's risk, and the buyer agrees to defend, indemnify and hold harmless Microchip from any and all damages, claims, suits, or expenses resulting from such use. No licenses are conveyed, implicitly or otherwise, under any Microchip intellectual property rights unless otherwise stated.

Microchip received ISO/TS-16949:2009 certification for its worldwide headquarters, design and wafer fabrication facilities in Chandler and Tempe, Arizona; Gresham, Oregon and design centers in California and India. The Company's quality system processes and procedures are for its PIC® MCUs and dsPIC® DSCs, KEELOQ® code hopping devices, Serial EEPROMs, microperipherals, nonvolatile memory and analog products. In addition, Microchip's quality system for the design and manufacture of development systems is ISO 9001:2000 certified.

**QUALITY MANAGEMENT SYSTEM
CERTIFIED BY DNV
= ISO/TS 16949 =**

Trademarks

The Microchip name and logo, the Microchip logo, AnyRate, AVR, AVR logo, AVR Freaks, BitCloud, chipKIT, chipKIT logo, CryptoMemory, CryptoRF, dsPIC, FlashFlex, flexPWR, Heldo, JukeBlox, KeeLoq, Klear, LANCheck, LINK MD, maXStylus, maXTouch, MediaLB, megaAVR, MOST, MOST logo, MPLAB, OptoLyzer, PIC, picoPower, PICSTART, PIC32 logo, Prochip Designer, QTouch, SAM-BA, SpyNIC, SST, SST Logo, SuperFlash, tinyAVR, UNI/O, and XMEGA are registered trademarks of Microchip Technology Incorporated in the U.S.A. and other countries.

ClockWorks, The Embedded Control Solutions Company, EtherSynch, Hyper Speed Control, HyperLight Load, IntellIMOS, mTouch, Precision Edge, and Quiet-Wire are registered trademarks of Microchip Technology Incorporated in the U.S.A.

Adjacent Key Suppression, AKS, Analog-for-the-Digital Age, Any Capacitor, AnyIn, AnyOut, BodyCom, CodeGuard, CryptoAuthentication, CryptoAutomotive, CryptoCompanion, CryptoController, dsPICDEM, dsPICDEM.net, Dynamic Average Matching, DAM, ECAN, EtherGREEN, In-Circuit Serial Programming, ICSP, INICnet, Inter-Chip Connectivity, JitterBlocker, KlearNet, KlearNet logo, memBrain, Mindi, MiWi, motorBench, MPASM, MPF, MPLAB Certified logo, MPLIB, MPLINK, MultiTRAK, NetDetach, Omniscient Code Generation, PICDEM, PICDEM.net, PICKit, PICtail, PowerSmart, PureSilicon, QMatrix, REAL ICE, Ripple Blocker, SAM-ICE, Serial Quad I/O, SMART-I.S., SQI, SuperSwitcher, SuperSwitcher II, Total Endurance, TSHARC, USBCheck, VariSense, ViewSpan, WiperLock, Wireless DNA, and ZENA are trademarks of Microchip Technology Incorporated in the U.S.A. and other countries.

SQTP is a service mark of Microchip Technology Incorporated in the U.S.A.

Silicon Storage Technology is a registered trademark of Microchip Technology Inc. in other countries.

GestIC is a registered trademark of Microchip Technology Germany II GmbH & Co. KG, a subsidiary of Microchip Technology Inc., in other countries.

All other trademarks mentioned herein are property of their respective companies.

© 2018, Microchip Technology Incorporated, All Rights Reserved.
ISBN: 978-1-5224-3735-2



MICROCHIP

Worldwide Sales and Service

AMERICAS

Corporate Office
2355 West Chandler Blvd.
Chandler, AZ 85224-6199
Tel: 480-792-7200
Fax: 480-792-7277
Technical Support:
<http://www.microchip.com/support>
Web Address:
www.microchip.com

Atlanta

Duluth, GA
Tel: 678-957-9614
Fax: 678-957-1455

Austin, TX

Tel: 512-257-3370

Boston

Westborough, MA
Tel: 774-760-0087
Fax: 774-760-0088

Chicago

Itasca, IL
Tel: 630-285-0071
Fax: 630-285-0075

Dallas

Addison, TX
Tel: 972-818-7423
Fax: 972-818-2924

Detroit

Novi, MI
Tel: 248-848-4000

Houston, TX

Tel: 281-894-5983

Indianapolis

Noblesville, IN
Tel: 317-773-8323
Fax: 317-773-5453
Tel: 317-536-2380

Los Angeles

Mission Viejo, CA
Tel: 949-462-9523
Fax: 949-462-9608
Tel: 951-273-7800

Raleigh, NC

Tel: 919-844-7510

New York, NY

Tel: 631-435-6000

San Jose, CA

Tel: 408-735-9110
Tel: 408-436-4270

Canada - Toronto

Tel: 905-695-1980
Fax: 905-695-2078

ASIA/PACIFIC

Australia - Sydney
Tel: 61-2-9868-6733

China - Beijing
Tel: 86-10-8569-7000

China - Chengdu
Tel: 86-28-8665-5511

China - Chongqing
Tel: 86-23-8980-9588

China - Dongguan
Tel: 86-769-8702-9880

China - Guangzhou
Tel: 86-20-8755-8029

China - Hangzhou
Tel: 86-571-8792-8115

China - Hong Kong SAR
Tel: 852-2943-5100

China - Nanjing
Tel: 86-25-8473-2460

China - Qingdao
Tel: 86-532-8502-7355

China - Shanghai
Tel: 86-21-3326-8000

China - Shenyang
Tel: 86-24-2334-2829

China - Shenzhen
Tel: 86-755-8864-2200

China - Suzhou
Tel: 86-186-6233-1526

China - Wuhan
Tel: 86-27-5980-5300

China - Xian
Tel: 86-29-8833-7252

China - Xiamen
Tel: 86-592-2388138

China - Zhuhai
Tel: 86-756-3210040

ASIA/PACIFIC

India - Bangalore
Tel: 91-80-3090-4444

India - New Delhi
Tel: 91-11-4160-8631

India - Pune
Tel: 91-20-4121-0141

Japan - Osaka
Tel: 81-6-6152-7160

Japan - Tokyo
Tel: 81-3-6880-3770

Korea - Daegu
Tel: 82-53-744-4301

Korea - Seoul
Tel: 82-2-554-7200

Malaysia - Kuala Lumpur
Tel: 60-3-7651-7906

Malaysia - Penang
Tel: 60-4-227-8870

Philippines - Manila
Tel: 63-2-634-9065

Singapore
Tel: 65-6334-8870

Taiwan - Hsin Chu
Tel: 886-3-577-8366

Taiwan - Kaohsiung
Tel: 886-7-213-7830

Taiwan - Taipei
Tel: 886-2-2508-8600

Thailand - Bangkok
Tel: 66-2-694-1351

Vietnam - Ho Chi Minh
Tel: 84-28-5448-2100

EUROPE

Austria - Wels
Tel: 43-7242-2244-39
Fax: 43-7242-2244-393

Denmark - Copenhagen
Tel: 45-4450-2828
Fax: 45-4485-2829

Finland - Espoo
Tel: 358-9-4520-820

France - Paris
Tel: 33-1-69-53-63-20
Fax: 33-1-69-30-90-79

Germany - Garching
Tel: 49-8931-9700

Germany - Haan
Tel: 49-2129-3766400

Germany - Heilbronn
Tel: 49-7131-67-3636

Germany - Karlsruhe
Tel: 49-721-625370

Germany - Munich
Tel: 49-89-627-144-0
Fax: 49-89-627-144-44

Germany - Rosenheim
Tel: 49-8031-354-560

Israel - Ra'anana
Tel: 972-9-744-7705

Italy - Milan
Tel: 39-0331-742611
Fax: 39-0331-466781

Italy - Padova
Tel: 39-049-7625286

Netherlands - Drunen
Tel: 31-416-690399
Fax: 31-416-690340

Norway - Trondheim
Tel: 47-7288-4388

Poland - Warsaw
Tel: 48-22-3325737

Romania - Bucharest
Tel: 40-21-407-87-50

Spain - Madrid
Tel: 34-91-708-08-90
Fax: 34-91-708-08-91

Sweden - Gothenberg
Tel: 46-31-704-60-40

Sweden - Stockholm
Tel: 46-8-5090-4654

UK - Wokingham
Tel: 44-118-921-5800
Fax: 44-118-921-5820

Looking for pricing, stock, or lifecycle information?

Click below to explore more details on WIN SOURCE:

- ⊖ [View MIC5237-3.3BU on WIN SOURCE](#)
- ⊖ [Microchip Technology](#) Information

Optimize Your Supply Chain with WIN SOURCE Solutions

- ✓ Global Sourcing Solution
- ✓ Obsolete Management
- ✓ Cost Control Management
- ✓ Shortage Management
- ✓ Alternative Solution
- ✓ Excess Inventory Management