



ON Semiconductor®

www.onsemi.com

MCH6431

Power MOSFET 30V, 55mΩ, 5A, Single N-Channel

Features

- Low On-Resistance
- 4V Drive
- ESD Diode-Protected Gate
- Pb-Free, Halogen Free and RoHS Compliance

Specifications

Absolute Maximum Ratings at Ta = 25°C

| Parameter | Symbol | Value | Unit |
|---|------------------|-------------|------|
| Drain to Source Voltage | V _{DSS} | 30 | V |
| Gate to Source Voltage | V _{GSS} | ±20 | V |
| Drain Current (DC) | I _D | 5 | A |
| Drain Current (Pulse) PW≤10μs, duty cycle≤1% | I _{DP} | 20 | A |
| Power Dissipation When mounted on ceramic substrate (1200mm ² × 0.8mm) | P _D | 1.5 | W |
| Junction Temperature | T _J | 150 | °C |
| Storage Temperature | T _{stg} | -55 to +150 | °C |

Thermal Resistance Ratings

| Parameter | Symbol | Value | Unit |
|---|------------------|-------|------|
| Junction to Ambient When mounted on ceramic substrate (1200mm ² × 0.8mm) | R _{θJA} | 83.3 | °C/W |

| V _{DSS} | R _{DS(on)} Max | I _D Max |
|------------------|-------------------------|--------------------|
| 30V | 55mΩ@ 10V | 5A |
| | 91mΩ@ 4.5V | |
| | 109mΩ@ 4V | |

Electrical Connection N-Channel

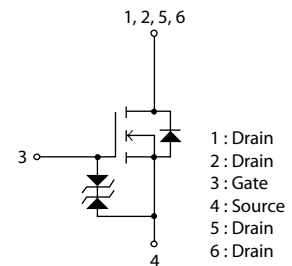

Packing Type : TL

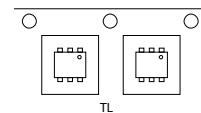

Marking

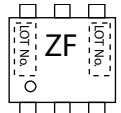

Stresses exceeding those listed in the Maximum Ratings table may damage the device. If any of these limits are exceeded, device functionality should not be assumed, damage may occur and reliability may be affected.

ORDERING INFORMATION

See detailed ordering and shipping information on page 5 of this data sheet.

MCH6431

Electrical Characteristics at $T_a = 25^\circ\text{C}$

| Parameter | Symbol | Conditions | Value | | | Unit |
|--|---------------|---|-----------------------------------|-----|----------|------------------|
| | | | min | typ | max | |
| Drain to Source Breakdown Voltage | $V_{(BR)DSS}$ | $I_D=1\text{mA}, V_{GS}=0\text{V}$ | 30 | | | V |
| Zero-Gate Voltage Drain Current | I_{DSS} | $V_{DS}=30\text{V}, V_{GS}=0\text{V}$ | | | 1 | μA |
| Gate to Source Leakage Current | I_{GSS} | $V_{GS}=\pm 16\text{V}, V_{DS}=0\text{V}$ | | | ± 10 | μA |
| Gate Threshold Voltage | $V_{GS(th)}$ | $V_{DS}=10\text{V}, I_D=1\text{mA}$ | 1.2 | | 2.6 | V |
| Forward Transconductance | g_{FS} | $V_{DS}=10\text{V}, I_D=2.5\text{A}$ | | 2.2 | | S |
| Static Drain to Source On-State Resistance | $R_{DS(on)1}$ | $I_D=2.5\text{A}, V_{GS}=10\text{V}$ | | 42 | 55 | $\text{m}\Omega$ |
| | $R_{DS(on)2}$ | $I_D=1.2\text{A}, V_{GS}=4.5\text{V}$ | | 65 | 91 | $\text{m}\Omega$ |
| | $R_{DS(on)3}$ | $I_D=1.2\text{A}, V_{GS}=4\text{V}$ | | 78 | 109 | $\text{m}\Omega$ |
| Input Capacitance | C_{iss} | $V_{DS}=10\text{V}, f=1\text{MHz}$ | | 280 | | pF |
| Output Capacitance | C_{oss} | | | 60 | | pF |
| Reverse Transfer Capacitance | C_{rss} | | | 30 | | pF |
| Turn-ON Delay Time | $t_{d(on)}$ | | | 5.7 | | ns |
| Rise Time | t_r | See specified Test Circuit | | 11 | | ns |
| Turn-OFF Delay Time | $t_{d(off)}$ | | | 21 | | ns |
| Fall Time | t_f | | | 10 | | ns |
| Total Gate Charge | Q_g | $V_{DS}=15\text{V}, V_{GS}=10\text{V}, I_D=5\text{A}$ | | 5.6 | | nC |
| Gate to Source Charge | Q_{gs} | | | 1.2 | | nC |
| Gate to Drain "Miller" Charge | Q_{gd} | | | 0.8 | | nC |
| Forward Diode Voltage | V_{SD} | | $I_S=5\text{A}, V_{GS}=0\text{V}$ | | 0.85 | 1.2 |

Product parametric performance is indicated in the Electrical Characteristics for the listed test conditions, unless otherwise noted. Product performance may not be indicated by the Electrical Characteristics if operated under different conditions.

Switching Time Test Circuit

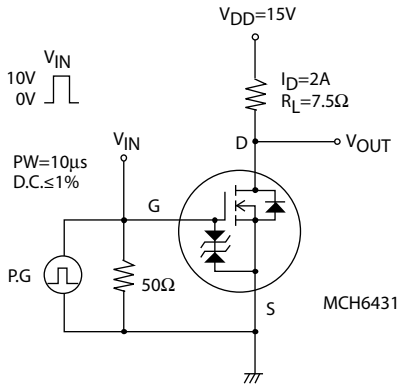

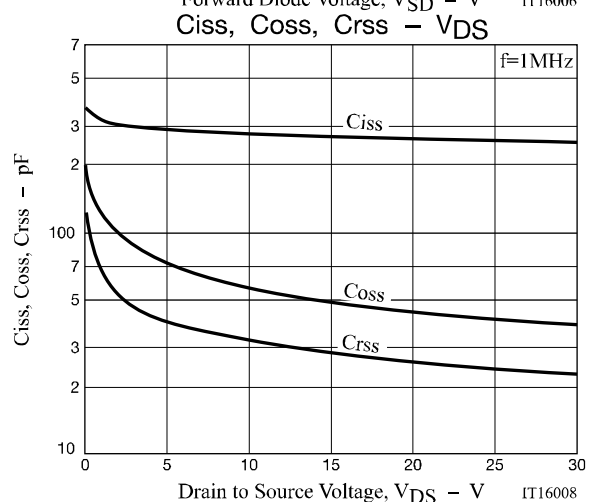
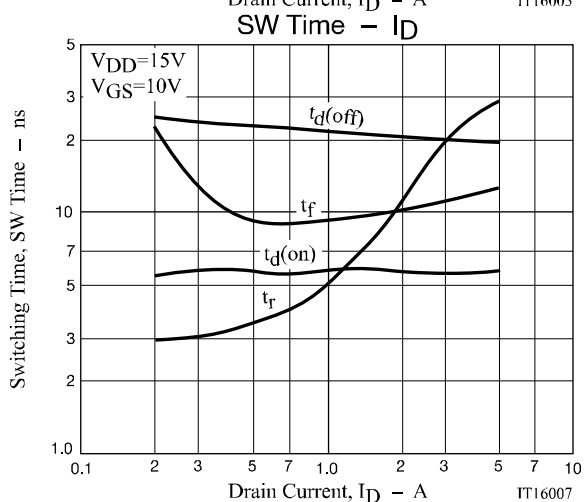
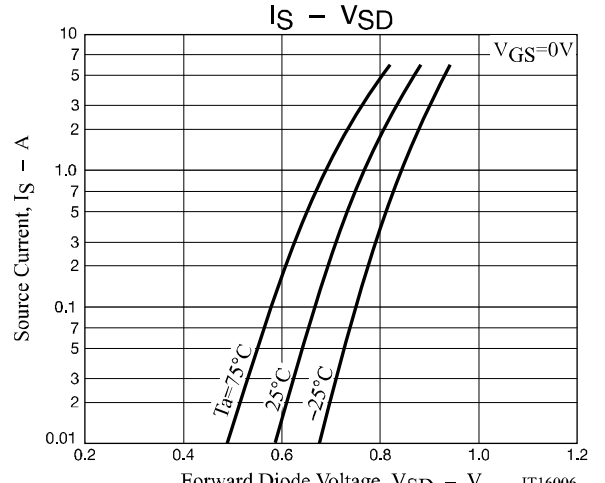
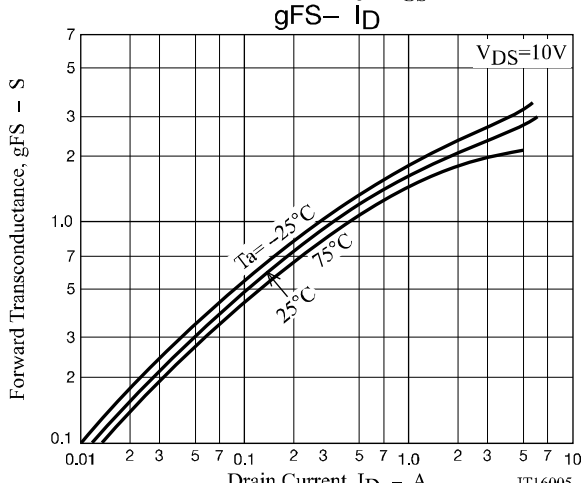
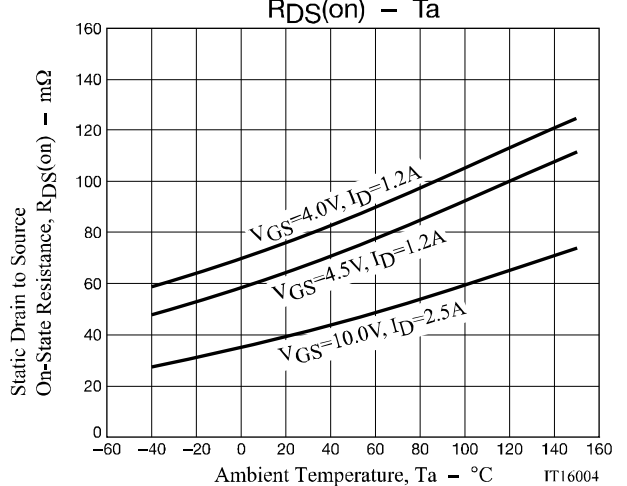
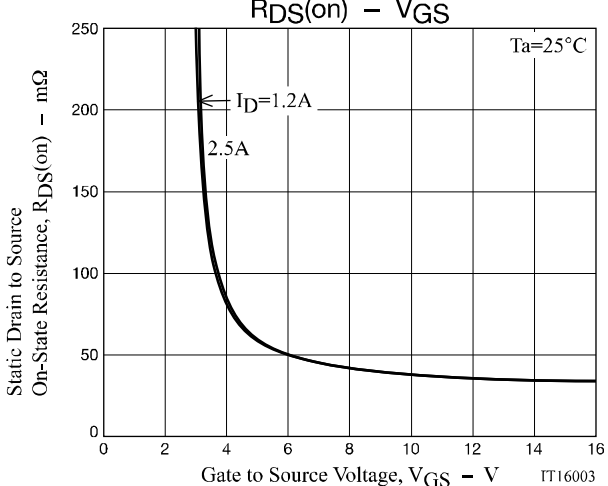
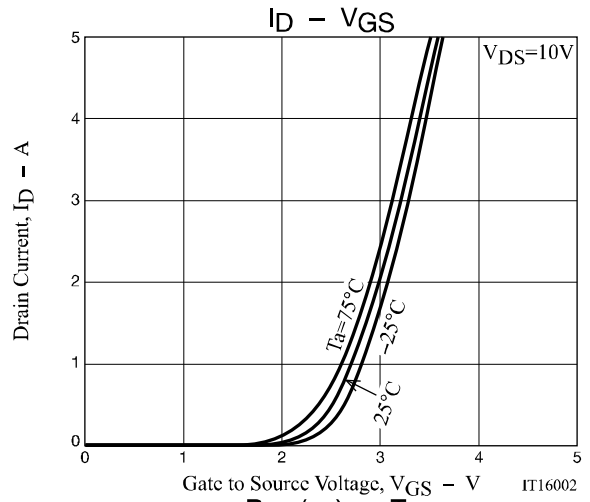
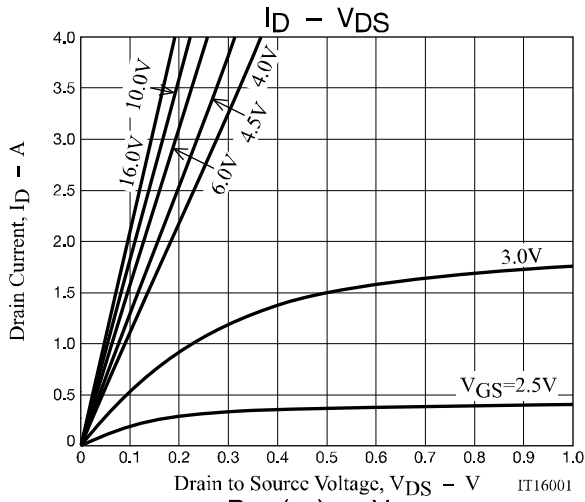

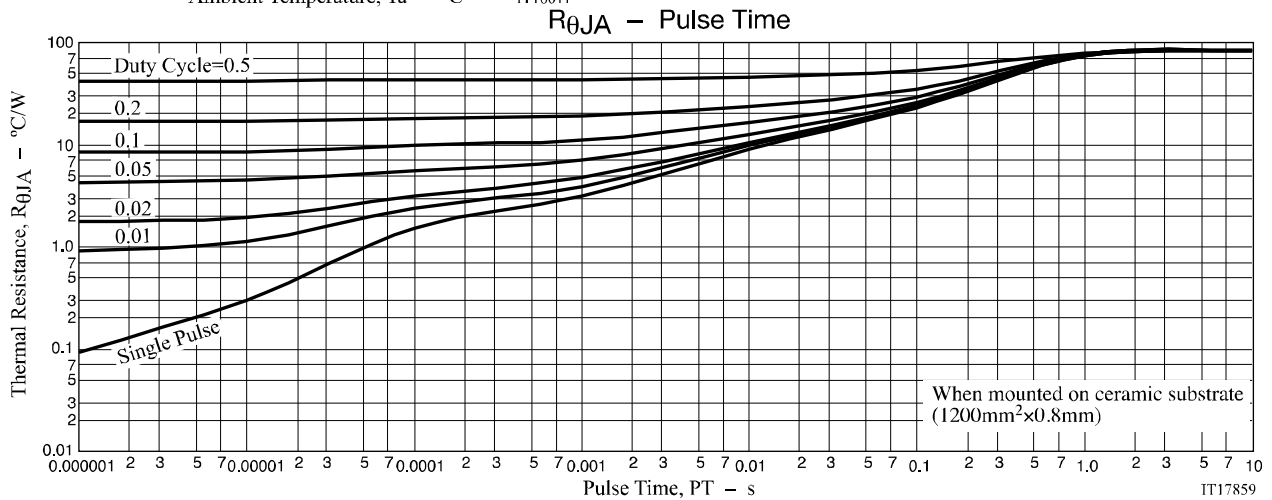
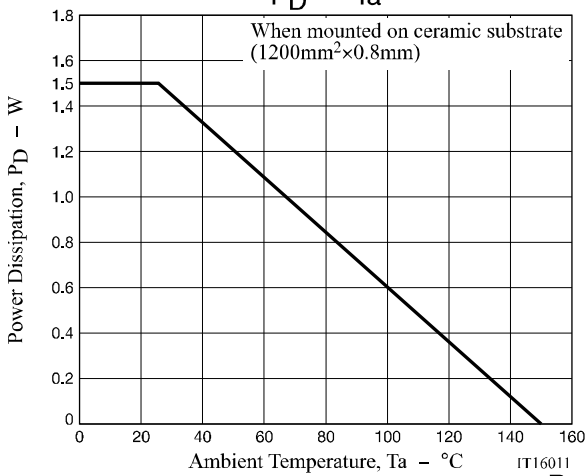
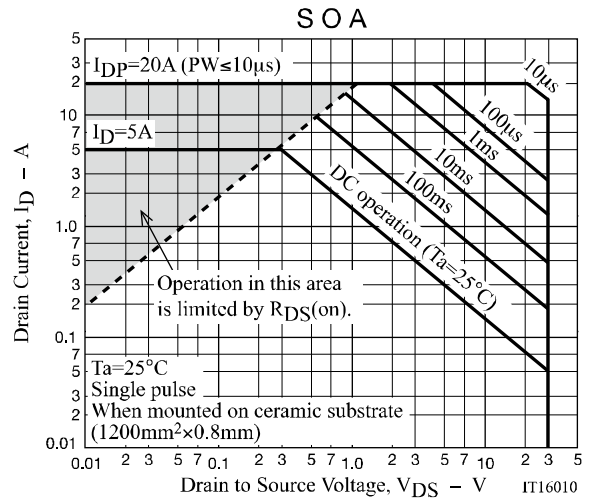
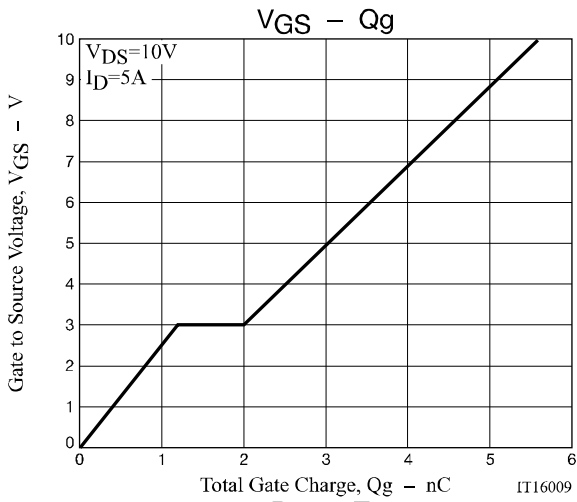



Looking for pricing, stock, or lifecycle information?

Click below to explore more details on WIN SOURCE:

-  [View MCH6431-TL-H on WIN SOURCE](#)
-  [ON Semiconductor](#) Information

Optimize Your Supply Chain with WIN SOURCE Solutions

-  Global Sourcing Solution
-  Obsolete Management
-  Cost Control Management
-  Shortage Management
-  Alternative Solution
-  Excess Inventory Management