



# THE DATASHEET OF CMSSH-3A TR



CMSSH-3  
 CMSSH-3A  
 CMSSH-3C  
 CMSSH-3S

**SURFACE MOUNT SILICON  
 SCHOTTKY DIODES**



**SOT-323 CASE**



[www.centrasemi.com](http://www.centrasemi.com)

**DESCRIPTION:**

The CENTRAL SEMICONDUCTOR CMSSH-3 series devices are silicon Schottky diodes, epoxy molded in an SOT-323 surface mount package, designed for fast switching applications requiring a low forward voltage drop.

**CMSSH-3:** SINGLE  
**CMSSH-3A:** DUAL, COMMON ANODE  
**CMSSH-3C:** DUAL, COMMON CATHODE  
**CMSSH-3S:** DUAL, IN SERIES

**MARKING CODE: 95D**  
**MARKING CODE: B1D**  
**MARKING CODE: B2D**  
**MARKING CODE: A5D**

**MAXIMUM RATINGS:** ( $T_A=25^\circ\text{C}$ )

Peak Repetitive Reverse Voltage  
 Continuous Forward Current  
 Peak Repetitive Forward Current  
 Peak Forward Surge Current,  $t_p=10\text{ms}$   
 Power Dissipation  
 Operating and Storage Junction Temperature  
 Thermal Resistance

SYMBOL		UNITS
$V_{RRM}$	30	V
$I_F$	100	mA
$I_{FRM}$	200	mA
$I_{FSM}$	750	mA
$P_D$	275	mW
$T_J, T_{stg}$	-65 to +150	$^\circ\text{C}$
$\theta_{JA}$	455	$^\circ\text{C/W}$

**ELECTRICAL CHARACTERISTICS PER DIODE:** ( $T_A=25^\circ\text{C}$  unless otherwise noted)

SYMBOL	TEST CONDITIONS	MIN	TYP	MAX	UNITS
$I_R$	$V_R=25\text{V}$		90	500	nA
$I_R$	$V_R=25\text{V}, T_A=100^\circ\text{C}$		25	100	$\mu\text{A}$
$BV_R$	$I_R=100\mu\text{A}$	30			V
$V_F$	$I_F=2.0\text{mA}$		0.29	0.33	V
$V_F$	$I_F=15\text{mA}$		0.37	0.45	V
$V_F$	$I_F=100\text{mA}$		0.51	1.00	V
$C_J$	$V_R=1.0\text{V}, f=1.0\text{MHz}$		7.0		pF
$t_{rr}$	$I_F=I_R=10\text{mA}, I_{rr}=1.0\text{mA}, R_L=100\Omega$			5.0	ns

CMSSH-3  
 CMSSH-3A  
 CMSSH-3C  
 CMSSH-3S

SURFACE MOUNT SILICON  
 SCHOTTKY DIODES



SOT-323 CASE - MECHANICAL OUTLINE

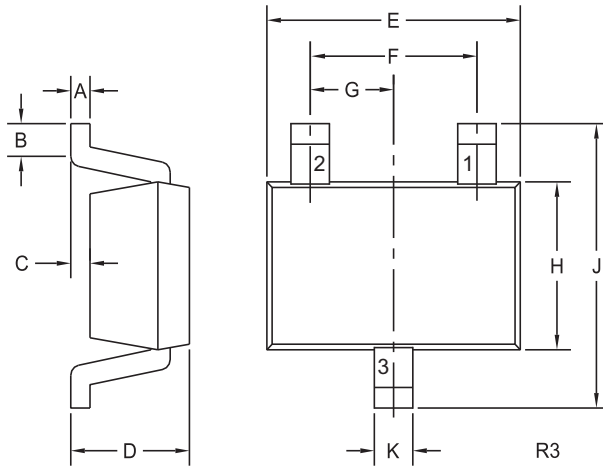

SYMBOL	DIMENSIONS			
	INCHES		MILLIMETERS	
	MIN	MAX	MIN	MAX
A	0.002	0.008	0.05	0.20
B	0.004	-	0.10	-
C	-	0.004	-	0.10
D	0.031	0.043	0.80	1.10
E	0.071	0.087	1.80	2.20
F	0.051		1.30	
G	0.026		0.65	
H	0.045	0.053	1.15	1.35
J	0.079	0.087	2.00	2.20
K	0.008	0.016	0.20	0.40

SOT-323 (REV: R3)

PIN CONFIGURATIONS

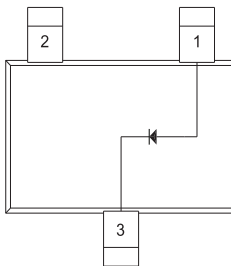

**CMSSH-3**

**LEAD CODE:**

- 1) Anode
- 2) NC
- 3) Cathode

**MARKING CODE: 95D**

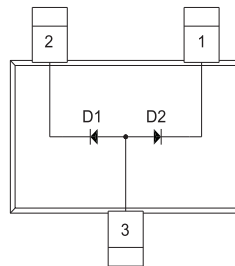

**CMSSH-3A**

**LEAD CODE:**

- 1) Cathode D2
- 2) Cathode D1
- 3) Anode D1, D2

**MARKING CODE: B1D**

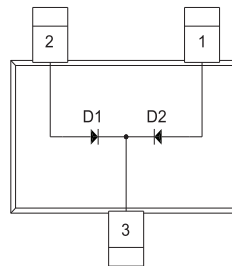

**CMSSH-3C**

**LEAD CODE:**

- 1) Anode D2
- 2) Anode D1
- 3) Cathode D1, D2

**MARKING CODE: B2D**

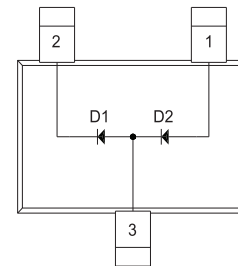

**CMSSH-3S**

**LEAD CODE:**

- 1) Anode D2
- 2) Cathode D1
- 3) Anode D1, Cathode D2

**MARKING CODE: A5D**

R4 (11-February 2016)

CMSSH-3  
 CMSSH-3A  
 CMSSH-3C  
 CMSSH-3S

SURFACE MOUNT SILICON  
 SCHOTTKY DIODES



TYPICAL ELECTRICAL CHARACTERISTICS

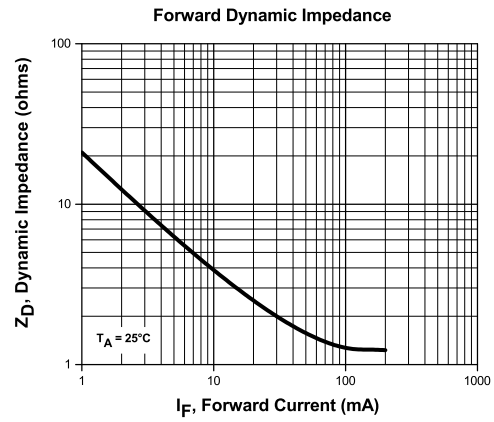
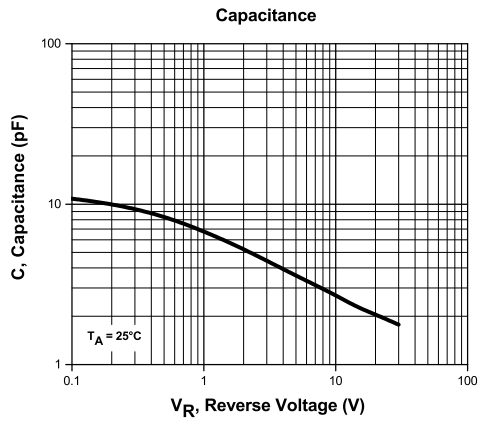
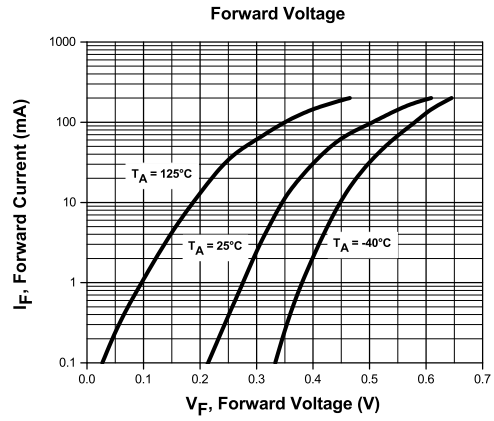
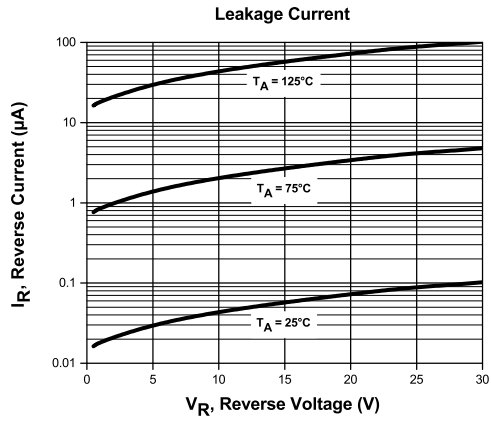

R4 (11-February 2016)

CMSSH-3  
 CMSSH-3A  
 CMSSH-3C  
 CMSSH-3S

SURFACE MOUNT SILICON  
 SCHOTTKY DIODES



TYPICAL ELECTRICAL CHARACTERISTICS

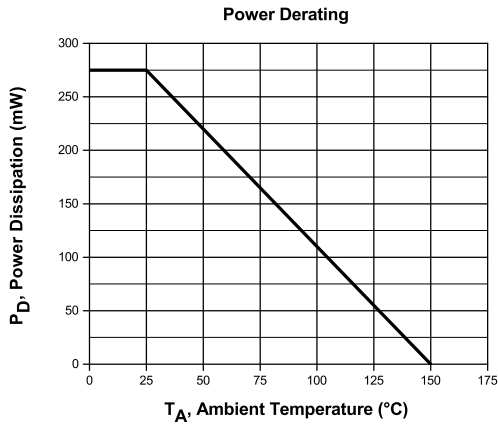
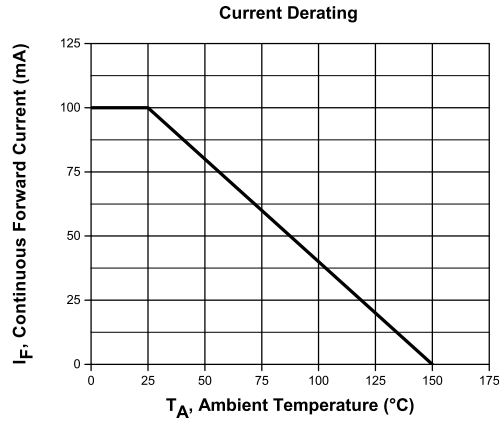
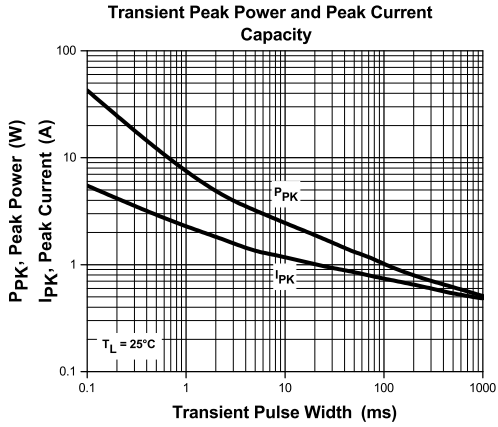

R4 (11-February 2016)

## OUTSTANDING SUPPORT AND SUPERIOR SERVICES



---

### PRODUCT SUPPORT

Central's operations team provides the highest level of support to insure product is delivered on-time.

- Supply management (Customer portals)
- Inventory bonding
- Consolidated shipping options
- Custom bar coding for shipments
- Custom product packing

---

### DESIGNER SUPPORT/SERVICES

Central's applications engineering team is ready to discuss your design challenges. Just ask.

- Free quick ship samples (2<sup>nd</sup> day air)
- Online technical data and parametric search
- SPICE models
- Custom electrical curves
- Environmental regulation compliance
- Customer specific screening
- Up-screening capabilities
- Special wafer diffusions
- PbSn plating options
- Package details
- Application notes
- Application and design sample kits
- Custom product and package development

---

### REQUESTING PRODUCT PLATING

1. If requesting Tin/Lead plated devices, add the suffix " TIN/LEAD" to the part number when ordering (example: 2N2222A TIN/LEAD).
2. If requesting Lead (Pb) Free plated devices, add the suffix " PBFREE" to the part number when ordering (example: 2N2222A PBFREE).

---

### CONTACT US

#### Corporate Headquarters & Customer Support Team

Central Semiconductor Corp.  
145 Adams Avenue  
Hauppauge, NY 11788 USA  
Main Tel: (631) 435-1110  
Main Fax: (631) 435-1824  
Support Team Fax: (631) 435-3388  
[www.centrasemi.com](http://www.centrasemi.com)

**Worldwide Field Representatives:**  
[www.centrasemi.com/wwreps](http://www.centrasemi.com/wwreps)



**Worldwide Distributors:**  
[www.centrasemi.com/wwdistributors](http://www.centrasemi.com/wwdistributors)

---

For the latest version of Central Semiconductor's **LIMITATIONS AND DAMAGES DISCLAIMER**, which is part of Central's Standard Terms and Conditions of sale, visit: [www.centrasemi.com/terms](http://www.centrasemi.com/terms)

## Looking for pricing, stock, or lifecycle information?

Click below to explore more details on WIN SOURCE:

-  [View CMSSH-3A TR on WIN SOURCE](#)
-  [Central Semiconductor Corp Information](#)

## Optimize Your Supply Chain with WIN SOURCE Solutions

-  Global Sourcing Solution
-  Obsolete Management
-  Cost Control Management
-  Shortage Management
-  Alternative Solution
-  Excess Inventory Management