



**THE DATASHEET OF
RT9030-12GU5**



150mA, Low Input Voltage, Low Dropout, Low Noise Ultra-Fast Without Bypass Capacitor CMOS LDO Regulator

General Description

The RT9030 is a high-performance, 150mA LDO regulator, offering extremely high PSRR and ultra-low dropout. Ideal for portable RF and wireless applications with demanding performance and space requirements.

The RT9030 quiescent current as low as 25µA, further prolonging the battery life. The RT9030 also works with low-ESR ceramic capacitors, reducing the amount of board space necessary for power applications, critical in hand-held wireless devices.

The RT9030 consumes typical 0.7µA in shutdown mode and has fast turn-on time less than 40µs. The other features include ultra-low dropout voltage, high output accuracy, current limiting protection, and high ripple rejection ratio. Available in the SC-70-5 and WDFN-6L 1.6x1.6 package.

Ordering Information

RT9030-□□□□	Package Type
	U5 : SC-70-5
	QW : WDFN-6L 1.6x1.6 (W-Type)
	Lead Plating System
	G : Green (Halogen Free and Pb Free)
	Fixed Output Voltage
	10 : 1.0V
	11 : 1.1V
	⋮
	32 : 3.2V
	33 : 3.3V
	1B : 1.25V
	1H : 1.85V
	2H : 2.85V
	1K : 1.05V

Note :

Richtek products are :

- ▶ RoHS compliant and compatible with the current requirements of IPC/JEDEC J-STD-020.
- ▶ Suitable for use in SnPb or Pb-free soldering processes.

Features

- Wide Operating Voltage Ranges : 1.65V to 5.5V
- Output Voltage Ranges : 1V to 3.3V
- Low Dropout : 100mV at 150mA
- Ultra-Low-Noise for RF Application
- Ultra-Fast Response in Line/Load Transient
- Current Limiting Protection
- Thermal Shutdown Protection
- High Power Supply Rejection Ratio
- Only 1µF Output Capacitor Required for Stability
- TTL-Logic-Controlled Shutdown Input
- RoHS Compliant and Halogen Free

Applications

- CDMA/GSM Cellular Handsets
- Portable Information Appliances
- Laptop, Palmtops, Notebook Computers
- Hand-Held Instruments
- Mini PCI & PCI-Express Cards
- PCMCIA & New Cards

Pin Configurations

(TOP VIEW)

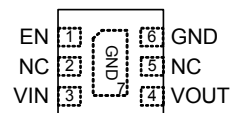
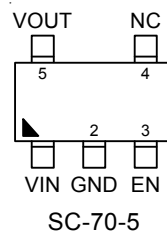

Marking Information

For marking information, contact our sales representative directly or through a Richtek distributor located in your area.

Typical Application Circuit

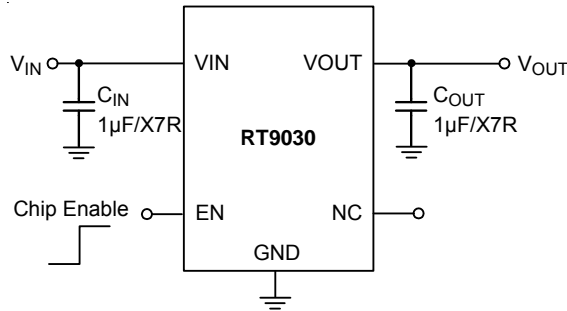

Functional Pin Description

Pin Number		Pin Name	Pin Function
SC-70-5	WDFN-6L 1.6x1.6		
5	4	VOUT	Regulator Output.
4	2, 5	NC	No Internal Connection.
2	6, 7 (Exposed Pad)	GND	Ground. The exposed pad must be soldered to a large PCB and connected to GND for maximum power dissipation.
3	1	EN	Enable Input Logic, Active High. When the EN pin is open it will be pulled to low internally.
1	3	VIN	Supply Input.

Function Block Diagram

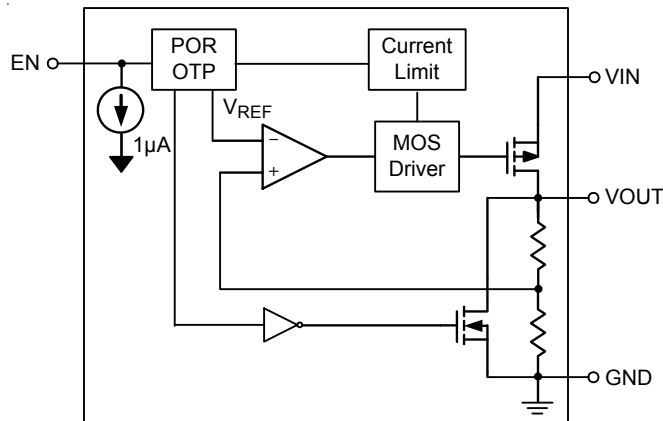

Absolute Maximum Ratings (Note 1)

- Supply Input Voltage ----- 6V
- EN Input Voltage ----- 6V
- Power Dissipation, P_D @ $T_A = 25^\circ\text{C}$
 - SC-70-5 ----- 0.3W
 - WDFN-6L 1.6x1.6 ----- 0.571W
- Package Thermal Resistance (Note 2)
 - SC-70-5, θ_{JA} ----- 333°C/W
 - WDFN-6L 1.6x1.6, θ_{JA} ----- 175°C/W
- Lead Temperature (Soldering, 10 sec.) ----- 260°C
- Junction Temperature ----- 150°C
- Storage Temperature Range ----- -65°C to 150°C
- ESD Susceptibility (Note 3)
 - HBM (Human Body Model) ----- 2kV
 - MM (Machine Model) ----- 200V

Recommended Operating Conditions (Note 4)

- Input Voltage Range ----- 1.65V to 5.5V
- Junction Temperature Range ----- -40°C to 125°C
- Ambient Temperature Range ----- -40°C to 85°C

Electrical Characteristics

($V_{IN} = V_{OUT} + 0.5V$, $V_{EN} = V_{IN}$, $C_{IN} = C_{OUT} = 1\mu\text{F}/X5R$ (Ceramic), $T_A = 25^\circ\text{C}$, unless otherwise specified)

Parameter	Symbol	Test Conditions	Min	Typ	Max	Unit
Output Noise Voltage	V_{ON}	$I_{OUT} = 0\text{mA}$	--	30	--	μV_{RMS}
Output Voltage Accuracy (Fixed Output Voltage)	ΔV_{OUT}	$I_{OUT} = 150\text{mA}$	-2	0	2	%
Quiescent Current (Note 5)	I_Q	$I_{OUT} = 0\text{mA}$	--	25	50	μA
Shutdown Current	I_{SHDN}	$V_{EN} = 0V$	--	0.7	1.5	μA
Current Limit	I_{LIM}	$R_{LOAD} = 0\Omega$, $1.65V \leq V_{IN} < 5.5V$	170	285	400	mA
Dropout Voltage (Note 6)	V_{DROP}	$V_{OUT} = 1.7V$ to $2.4V$, $I_{OUT} = 150\text{mA}$, $1.65V \leq V_{IN} \leq 5.5V$	50	--	200	mV
		$V_{OUT} = 2.5V$ to $3.3V$, $I_{OUT} = 150\text{mA}$, $1.65V \leq V_{IN} \leq 5.5V$	20	--	150	
Load Regulation (Note 7) (Fixed Output Voltage)	ΔV_{LOAD}	$1\text{mA} < I_{OUT} < 150\text{mA}$ $1.65V \leq V_{IN} \leq 5.5V$	--	--	1	%
EN Threshold	Logic-Low Voltage	V_{IL}	0	--	0.3	V
	Logic-High Voltage	V_{IH}	1.6	--	5.5	
Enable Pin Current	I_{EN}		--	1	3	μA
Power Supply Rejection Rate	$f = 1\text{kHz}$	PSRR	--	-67	--	dB
	$f = 10\text{kHz}$		--	-55	--	
	$f = 100\text{kHz}$		--	-40	--	

Parameter	Symbol	Test Conditions	Min	Typ	Max	Unit
Line Regulation	ΔV_{LINE}	$V_{IN} = (V_{OUT} + 0.5)$ to 5.5V, $I_{OUT} = 1mA$ to 150mA	--	0.01	0.2	%/V
Thermal Shutdown Temperature	T_{SD}		--	150	--	°C
Thermal Shutdown Hysteresis	ΔT_{SD}		--	20	--	

Note 1. Stresses beyond those listed “Absolute Maximum Ratings” may cause permanent damage to the device. These are stress ratings only, and functional operation of the device at these or any other conditions beyond those indicated in the operational sections of the specifications is not implied. Exposure to absolute maximum rating conditions may affect device reliability.

Note 2. θ_{JA} is measured at $T_A = 25^\circ C$ on a low effective thermal conductivity single-layer test board per JEDEC 51-3.

Note 3. Devices are ESD sensitive. Handling precaution is recommended.

Note 4. The device is not guaranteed to function outside its operating conditions.

Note 5. Quiescent, or ground current, is the difference between input and output currents. It is defined by $I_Q = I_{IN} - I_{OUT}$ under no load condition ($I_{OUT} = 0mA$). The total current drawn from the supply is the sum of the load current plus the ground pin current.

Note 6. The dropout voltage is defined as $V_{IN} - V_{OUT}$, which is measured when V_{OUT} is $V_{OUT(NORMAL)} - 100mV$.

Note 7. Regulation is measured at constant junction temperature by using a 2ms current pulse. Devices are tested for load regulation in the load range from 10mA to 120mA.

Typical Operating Characteristics

Output Voltage vs. Temperature

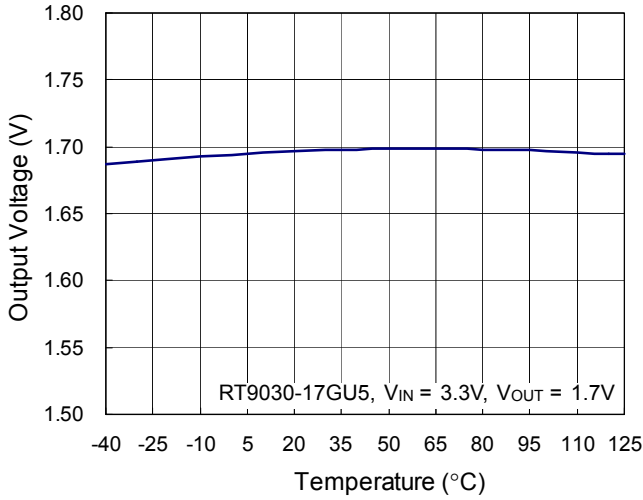

Quiescent Current vs. Temperature

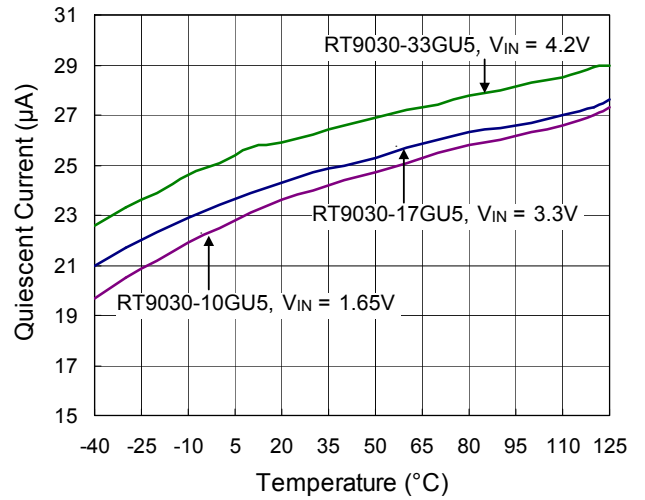

Dropout Voltage vs. Load Current

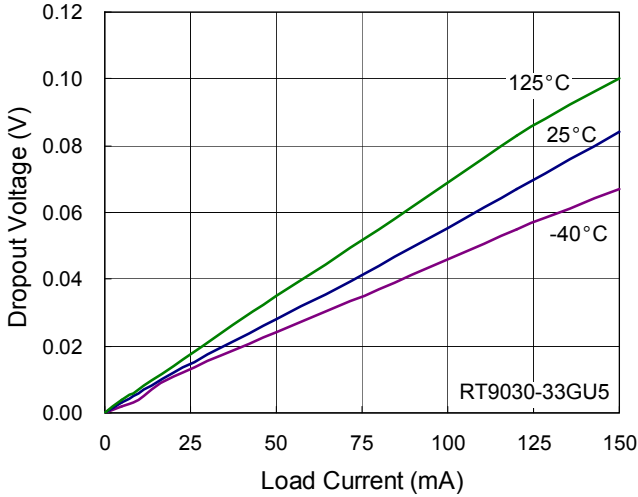

Dropout Voltage vs. Load Current

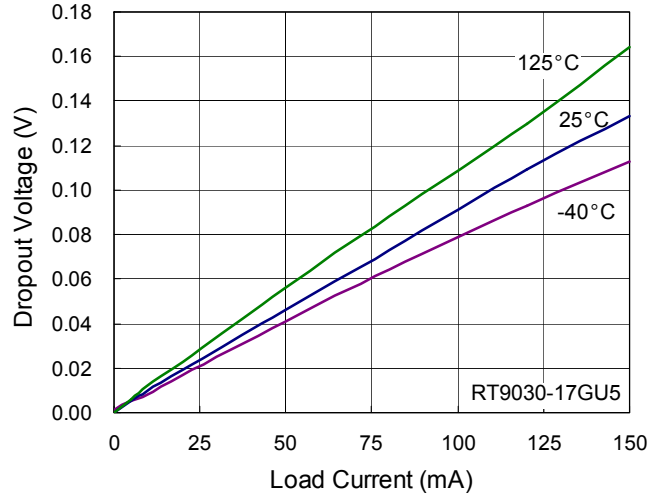

Power On from EN

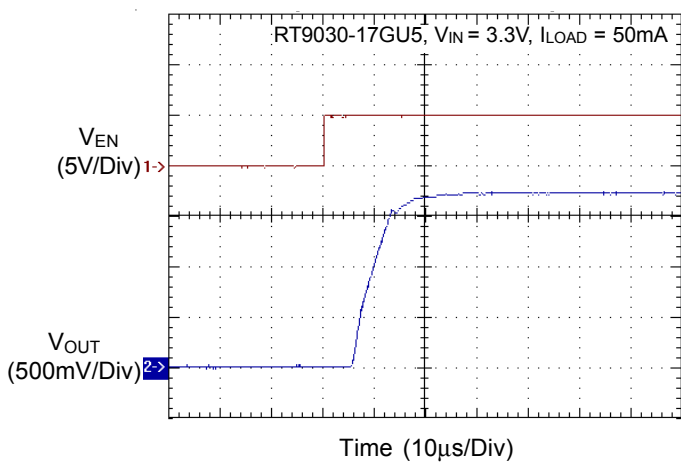

Power Off from EN

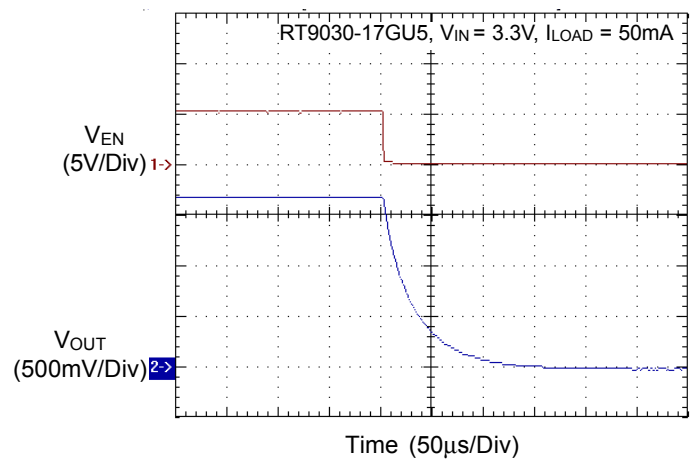

Line Transient Response

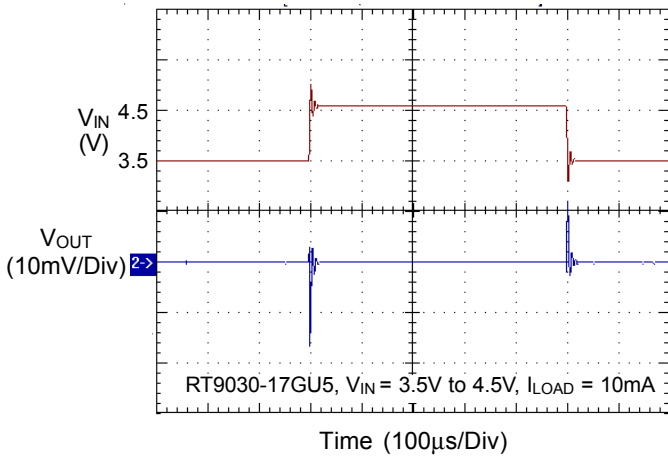

Line Transient Response

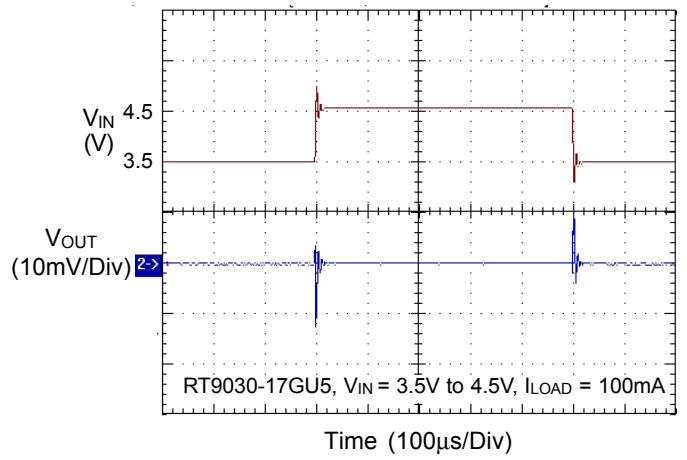

Load Transient Response

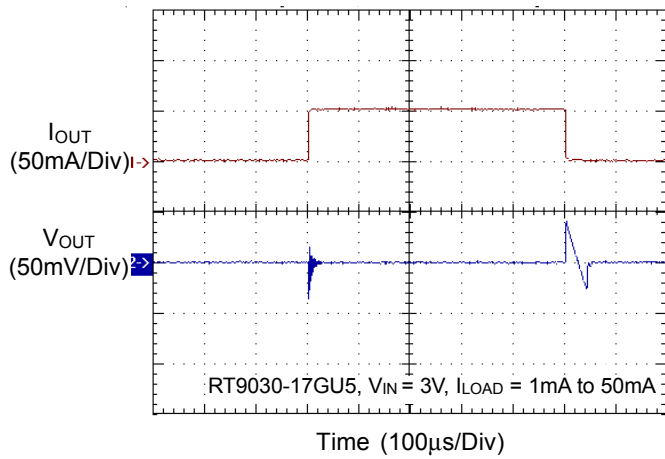

Load Transient Response

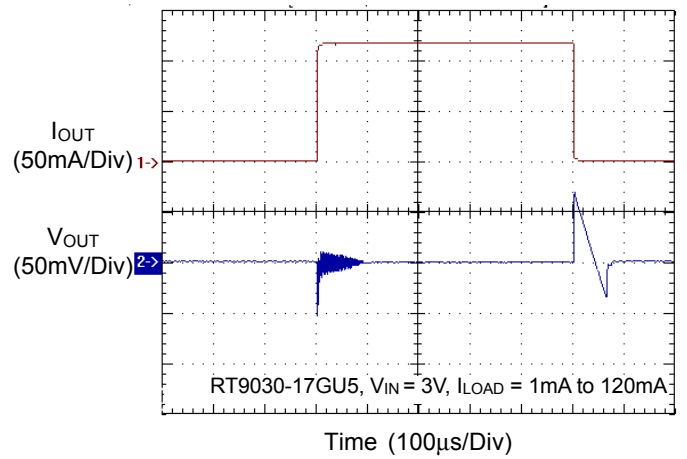

Noise

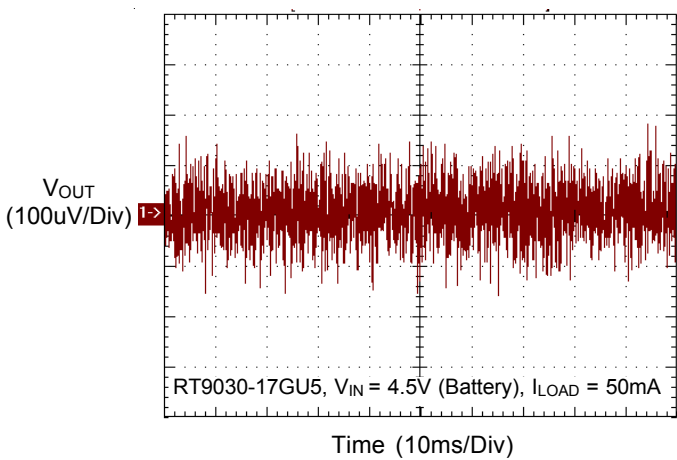

PSRR

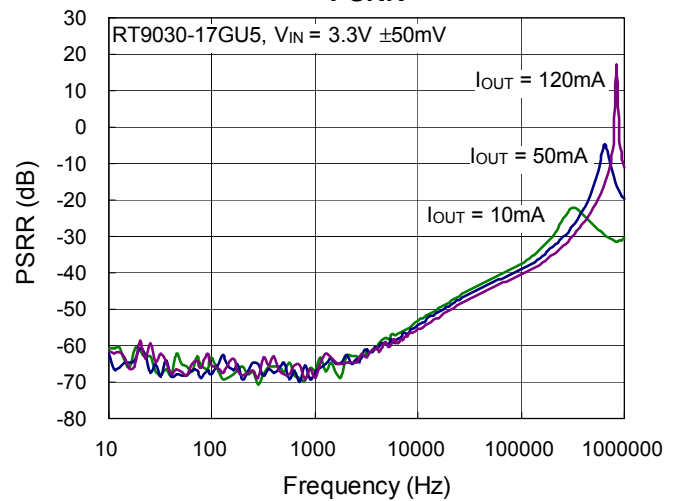

Applications Information

Capacitor Selection

In order to confirm the regulator stability and performance, X7R/X5R or other better quality ceramic capacitor should be selected.

Like any low-dropout regulator, the external capacitors used with the RT9030 must be carefully selected for regulator stability and performance. Using a capacitor whose value is larger than 1μF on the RT9030 input and the amount of capacitance can be increased without limit. The input capacitor should be located in a distance of no more than 0.5 inch from the input pin of the IC and returned to a clean analog ground. The capacitor with larger value and lower ESR (equivalent series resistance) provides better PSRR and line-transient response.

The output capacitor must meet both requirements for minimum amount of capacitance in all LDOs application. The RT9030 is designed specifically to work with low ESR ceramic output capacitor in space-saving and performance consideration. Using a ceramic capacitor whose value is at least 1μF on the RT9030 output ensures stability. Output capacitor with larger capacitance can reduce noise and improve load transient response, stability, and PSRR. The output capacitor should be located in a distance of no more than 0.5 inch from the VOUT pin of the RT9030 and returned to a clean analog ground.

Enable

The RT9030 goes into shutdown mode when the EN pin is in a logic low condition. During this condition, the pass transistor, error amplifier, and bandgap are turned off, reducing the supply current to 0.7μA typical. The EN pin can be directly tied to VIN to keep the part on.

Current limit

The RT9030 contains an independent current limiter, which monitors and controls the pass transistor's gate voltage, limiting the output current to 285mA (typ.). The output can be shorted to ground indefinitely without damaging the part.

Thermal Shutdown Protection

As the die temperature is > 150°C, the chip will enter protection mode. The power MOSFET will turn-off during protection mode to prevent abnormal operation.

Thermal Considerations

Thermal protection limits power dissipation in the RT9030. When the operation junction temperature exceeds 170°C, the OTP circuit starts the thermal shutdown function and turns the pass element off. The pass element turn on again after the junction temperature cools by 30°C.

For continuous operation, do not exceed absolute maximum operation junction temperature 125°C. The power dissipation definition in device is :

$$P_D = (V_{IN} - V_{OUT}) \times I_{OUT} + V_{IN} \times I_Q$$

The maximum power dissipation depends on the thermal resistance of IC package, PCB layout, the rate of surroundings airflow and temperature difference between junction to ambient. The maximum power dissipation can be calculated by following formula :

$$P_{D(MAX)} = (T_{J(MAX)} - T_A) / \theta_{JA}$$

Where $T_{J(MAX)}$ is the maximum operation junction temperature, T_A is the ambient temperature and the θ_{JA} is the junction to ambient thermal resistance.

For recommended operating conditions specification the maximum junction temperature of the die is 125°C. The junction to ambient thermal resistance θ_{JA} for WDFN-6L 1.6x1.6 package is 165°C/W and SC-70-5 package is 333°C/W on the standard JEDEC 51-3 single-layer thermal test board. The maximum power dissipation at $T_A = 25^\circ\text{C}$ can be calculated by following formula :

$$P_{D(MAX)} = (125^\circ\text{C} - 25^\circ\text{C}) / (165^\circ\text{C/W}) = 0.606\text{W for WDFN-6L 1.6x1.6 packages}$$

$$P_{D(MAX)} = (125^\circ\text{C} - 25^\circ\text{C}) / (333^\circ\text{C/W}) = 0.300\text{W for SC-70-5 packages}$$

The maximum power dissipation depends on operating ambient temperature for fixed $T_{J(MAX)}$ and thermal resistance θ_{JA} . The Figure 3 of derating curves allows the

designer to see the effect of rising ambient temperature on the maximum power allowed.

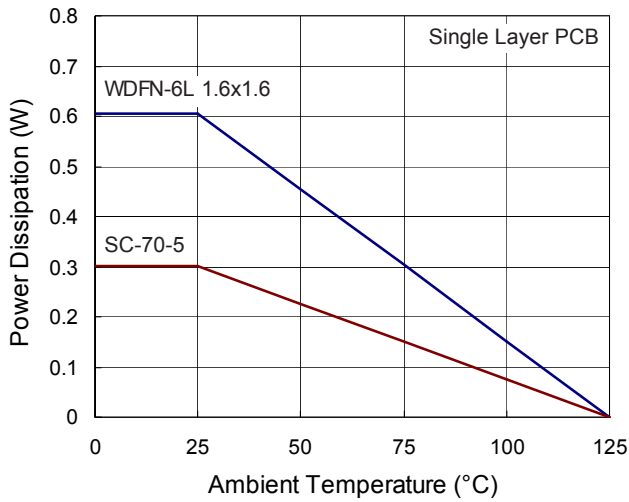

Figure 3. Derating Curve of Maximum Power Dissipation

Layout Considerations

Careful PCB Layout is necessary for better performance.

The following guidelines should be followed for good PCB layout.

- ▶ Place the input and output capacitors as close as possible to the IC.
- ▶ Keep VIN and VOUT trace as possible as short and wide.
- ▶ Use a large PCB ground plane for maximum thermal dissipation.

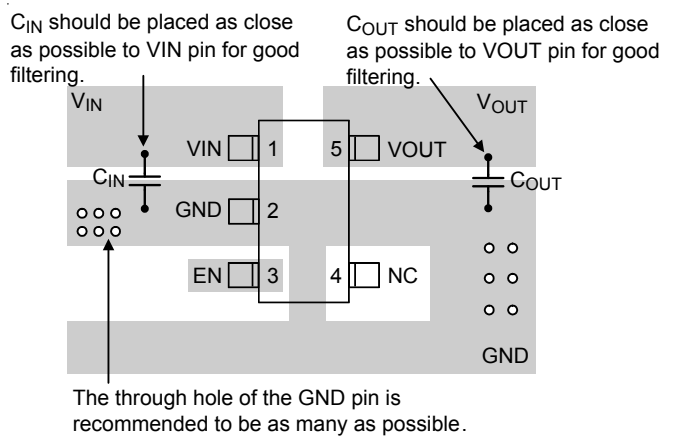
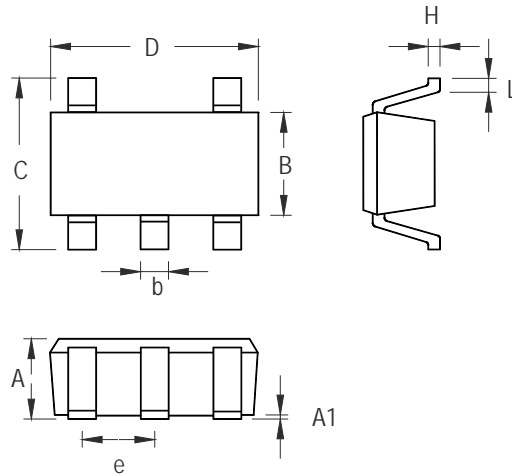

Figure 4

Outline Dimension



Symbol	Dimensions In Millimeters		Dimensions In Inches	
	Min	Max	Min	Max
A	0.800	1.100	0.031	0.044
A1	0.000	0.100	0.000	0.004
B	1.150	1.350	0.045	0.054
b	0.150	0.400	0.006	0.016
C	1.800	2.450	0.071	0.096
D	1.800	2.250	0.071	0.089
e	0.650		0.026	
H	0.080	0.260	0.003	0.010
L	0.210	0.460	0.008	0.018

SC-70-5 Surface Mount Package

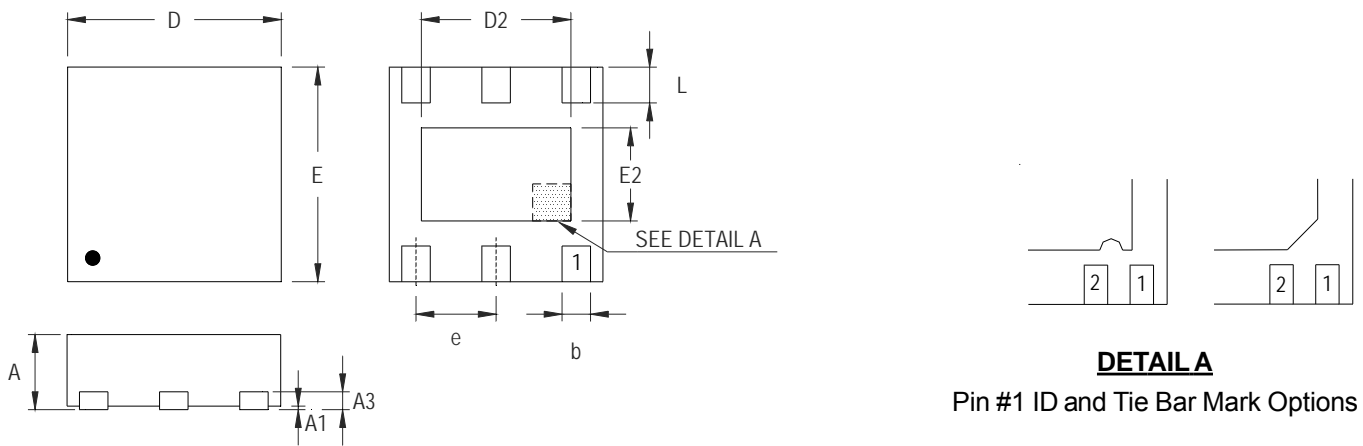

DETAIL A

Pin #1 ID and Tie Bar Mark Options

Note : The configuration of the Pin #1 identifier is optional, but must be located within the zone indicated.

Symbol	Dimensions In Millimeters		Dimensions In Inches	
	Min	Max	Min	Max
A	0.700	0.800	0.028	0.031
A1	0.000	0.050	0.000	0.002
A3	0.175	0.250	0.007	0.010
b	0.200	0.300	0.008	0.012
D	1.550	1.650	0.061	0.065
D2	0.950	1.050	0.037	0.041
E	1.550	1.650	0.061	0.065
E2	0.550	0.650	0.022	0.026
e	0.500		0.020	
L	0.190	0.290	0.007	0.011

W-Type 6L DFN 1.6x1.6 Package



Richtek Technology Corporation

14F, No. 8, Tai Yuen 1st Street, Chupei City
 Hsinchu, Taiwan, R.O.C.
 Tel: (8863)5526789

Richtek products are sold by description only. Richtek reserves the right to change the circuitry and/or specifications without notice at any time. Customers should obtain the latest relevant information and data sheets before placing orders and should verify that such information is current and complete. Richtek cannot assume responsibility for use of any circuitry other than circuitry entirely embodied in a Richtek product. Information furnished by Richtek is believed to be accurate and reliable. However, no responsibility is assumed by Richtek or its subsidiaries for its use; nor for any infringements of patents or other rights of third parties which may result from its use. No license is granted by implication or otherwise under any patent or patent rights of Richtek or its subsidiaries.

Looking for pricing, stock, or lifecycle information?

Click below to explore more details on WIN SOURCE:

-  [View RT9030-12GU5 on WIN SOURCE](#)
-  [Richtek USA Inc. Information](#)

Optimize Your Supply Chain with WIN SOURCE Solutions

-  Global Sourcing Solution
-  Obsolete Management
-  Cost Control Management
-  Shortage Management
-  Alternative Solution
-  Excess Inventory Management