



**THE DATASHEET OF
ISL6445IAZ-TK**



ISL6445

1.4MHz Dual, 180° Out-of-Phase, Step-Down PWM Controller

FN9230
Rev 1.00
Jun 3, 2008

The ISL6445 is a high-performance, dual-output PWM controller optimized for converting wall adapter, battery or network intermediate bus DC input supplies into the system supply voltages required for a wide variety of applications. Each output is adjustable down to 0.8V. The two PWMs are synchronized 180° out-of-phase reducing the RMS input current and ripple voltage.

The ISL6445 incorporates several protection features. An adjustable overcurrent protection circuit monitors the output current by sensing the voltage drop across the lower MOSFET. Hiccup mode overcurrent operation protects the DC/DC components from damage during output overload/short circuit conditions. Each PWM has an independent logic-level shutdown input ($\overline{SD1}$ and $\overline{SD2}$).

A single PGOOD signal is issued when soft-start is complete on both PWM controllers and their outputs are within 10% of the set point. Thermal shutdown circuitry turns off the device if the junction temperature exceeds +150°C.

Pinout

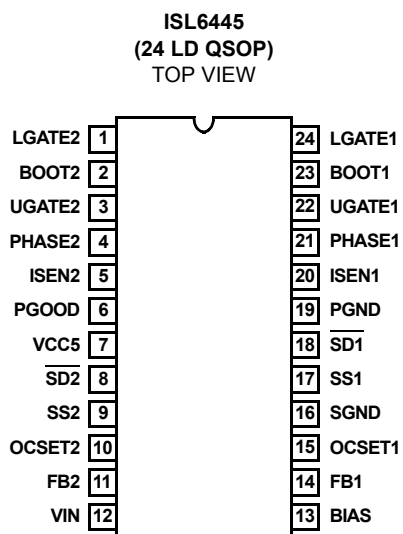

Features

- Wide Input Supply Voltage Range
 - 5.6V to 24V
 - 4.5V to 5.6V
- Two Independently Programmable Output Voltages
- Switching Frequency 1.4MHz
- Out-of-Phase PWM Controller Operation
 - Reduces Required Input Capacitance and Power Supply Induced Loads
- No External Current Sense Resistor
 - Uses Lower MOSFET's $r_{DS(ON)}$
- Programmable Soft-Start
- Extensive Circuit Protection Functions
 - PGOOD
 - UVLO
 - Overcurrent
 - Over-temperature
 - Independent Shutdown for Both PWMs
- Excellent Dynamic Response
 - Voltage Feed-Forward with Current Mode Control
- Pb-Free (RoHS Compliant)

Applications

- Power Supplies with Two Outputs
- xDSL Modems/Routers
- DSP, ASIC, and FPGA Power Supplies
- Set-Top Boxes
- Dual Output Supplies for DSP, Memory, Logic, μ P Core and I/O
- Telecom Systems

Ordering Information

PART NUMBER (Note)	PART MARKING	TEMP. RANGE (°C)	PACKAGE (Pb-Free)	PKG. DWG. #
ISL6445IAZ*	ISL 6445IAZ	-40 to +85	24 Ld QSOP	M24.15

*Add "-TK" suffix for tape and reel. Please refer to TB347 for details on reel specifications.

NOTE: These Intersil Pb-free plastic packaged products employ special Pb-free material sets, molding compounds/die attach materials, and 100% matte tin plate plus anneal (e3 termination finish, which is RoHS compliant and compatible with both SnPb and Pb-free soldering operations). Intersil Pb-free products are MSL classified at Pb-free peak reflow temperatures that meet or exceed the Pb-free requirements of IPC/JEDEC J STD-020.

Block Diagram

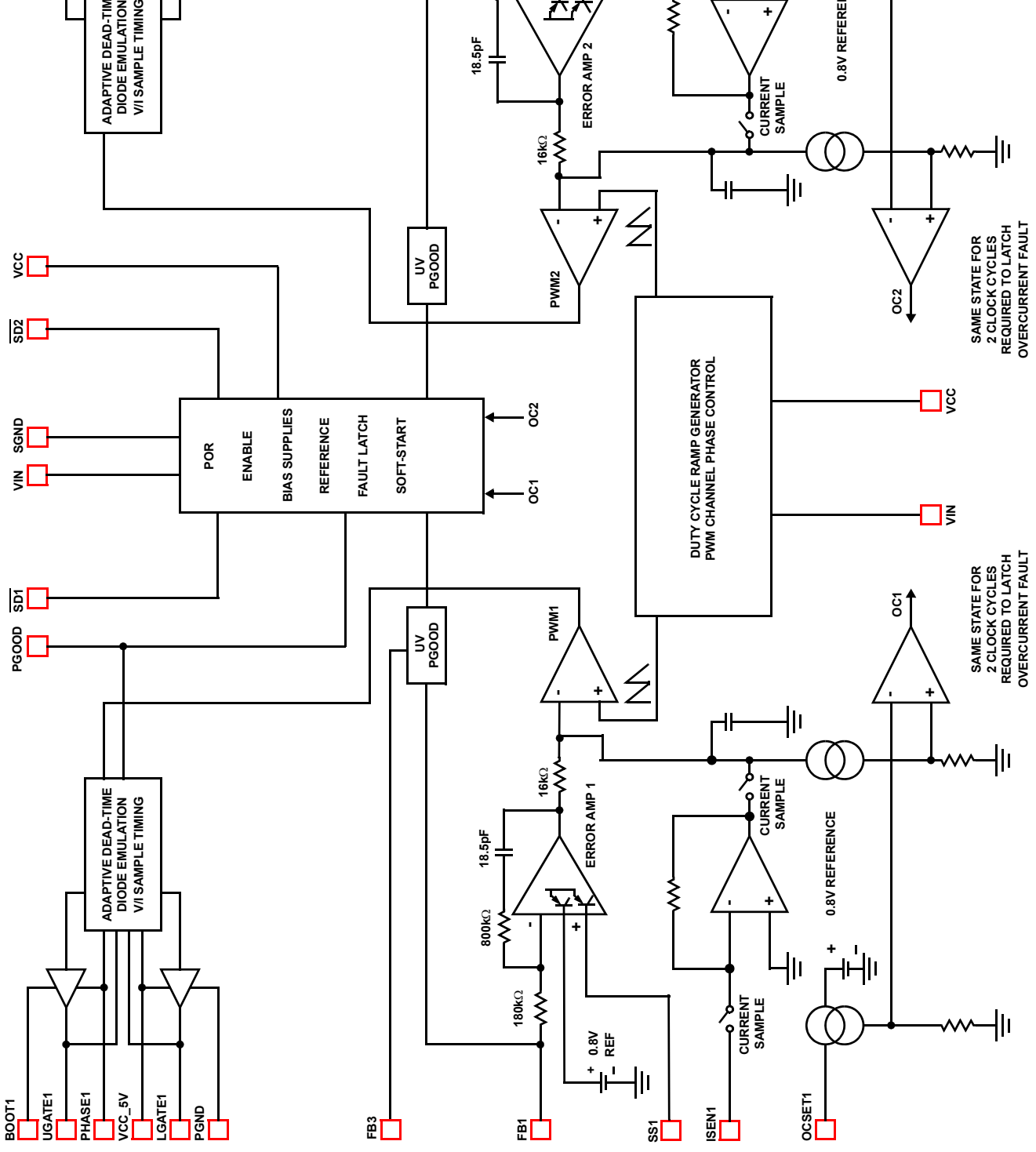

Absolute Maximum Ratings

Supply Voltage (VCC_5V Pin)	-0.3V to +7V
Input Voltage (VIN Pin)	+27V
BOOT1, 2 and UGATE1, 2	+35V
PHASE1, 2 and ISEN1, 2	+27V
BOOT1, 2 with Respect to PHASE1, 2	+6.5V
UGATE1, 2	(PHASE1, 2 - 0.3V) to (BOOT1, 2 +0.3V)

Thermal Information

Thermal Resistance (Typical)	θ_{JA} (°C/W)
24 Lead QSOP (Note 1)	85
Maximum Junction Temperature (Plastic Package)	-55°C to +150°C
Maximum Storage Temperature Range	-65°C to +150°C
Temperature Range	-40°C to +85°C
Pb-Free Reflow Profile	see link below
	http://www.intersil.com/pbfree/Pb-FreeReflow.asp

CAUTION: Do not operate at or near the maximum ratings listed for extended periods of time. Exposure to such conditions may adversely impact product reliability and result in failures not covered by warranty.

NOTE:

- θ_{JA} is measured with the component mounted on a high effective thermal conductivity test board in free air. See Tech Brief TB379 for details.

Electrical Specifications

Recommended operating conditions unless otherwise noted. Refer to "Block Diagram" on page 3 and "Typical Application Schematic" on page 2. V_{IN} = 5.6V to 24V, or V_{CC5} = 5V \pm 10%, T_A = -40°C to +85°C, Typical values are at T_A = +25°C. Parameters with MIN and/or MAX limits are 100% tested at +25°C, unless otherwise specified. Temperature limits established by characterization and are not production tested.

PARAMETER	TEST CONDITIONS	MIN	TYP	MAX	UNITS
VIN SUPPLY					
Input Voltage Range		5.6	12	24	V
VCC_5V SUPPLY (Note 2)					
Input Voltage		4.5	5.0	5.6	V
Output Voltage	$V_{IN} > 5.6V, I_L = 20mA$	4.5	5.0	5.5	V
Maximum Output Current	$V_{IN} = 12V$	60	-	-	mA
SUPPLY CURRENT					
Shutdown Current (Note 3)	$\overline{SD1} = \overline{SD2} = GND$	-	50	375	μA
Operating Current (Note 4)		-	2.0	4.0	mA
REFERENCE SECTION					
Nominal Reference Voltage		-	0.8	-	V
Reference Voltage Tolerance		-1.0	-	1.0	%
POWER-ON RESET					
Rising VCC_5V Threshold		4.25	4.45	4.5	V
Falling VCC_5V Threshold		3.95	4.2	4.4	V
OSCILLATOR					
Total Frequency Variation		1.25	1.4	1.55	MHz
Peak-to-Peak Sawtooth Amplitude (Note 5)	$V_{IN} = 12V$	-	1.6	-	V
	$V_{IN} = 5V$	-	0.667	-	V
Ramp Offset (Note 6)		-	1.0	-	V
SHUTDOWN1/SHUTDOWN2					
HIGH Level (Converter Enabled)	Internal Pull-up (3 μA)	2.0	-	-	V
LOW Level (Converter Disabled)		-	-	0.8	V
PWM CONVERTERS					
Output Voltage		-	0.8	-	V
FB Pin Bias Current		-	-	150	nA
Maximum Duty Cycle	PWM1, $C_{OUT} = 1000pF, T_A = +25^\circ C$	71	-	-	%
	PWM2, $C_{OUT} = 1000pF, T_A = +25^\circ C$	73	-	-	%

Electrical Specifications Recommended operating conditions unless otherwise noted. Refer to “Block Diagram” on page 3 and “Typical Application Schematic” on page 2. $V_{IN} = 5.6V$ to $24V$, or $VCC5 = 5V \pm 10\%$, $T_A = -40^\circ C$ to $+85^\circ C$, Typical values are at $T_A = +25^\circ C$. Parameters with MIN and/or MAX limits are 100% tested at $+25^\circ C$, unless otherwise specified. Temperature limits established by characterization and are not production tested. **(Continued)**

PARAMETER	TEST CONDITIONS	MIN	TYP	MAX	UNITS
Minimum Duty Cycle		-	4	-	%
PWM CONTROLLER ERROR AMPLIFIERS					
DC Gain (Note 6)		80	88	-	dB
Gain-Bandwidth Product (Note 6)		5.9	-	-	MHz
Slew Rate (Note 6)		-	2.0	-	V/ μs
Maximum Output Voltage (Note 6)		0.9	-	-	V
Minimum Output Voltage (Note 6)		-	-	3.6	V
PWM CONTROLLER GATE DRIVERS (Note 7)					
Sink/Source Current		-	400	-	mA
Upper Drive Pull-Up Resistance	$VCC5 = 4.5V$	-	8	-	Ω
Upper Drive Pull-Down Resistance	$VCC5 = 4.5V$	-	3.2	-	Ω
Lower Drive Pull-Up Resistance	$VCC5 = 4.5V$	-	8	-	Ω
Lower Drive Pull-Down Resistance	$VCC5 = 4.5V$	-	1.8	-	Ω
Rise Time	$C_{OUT} = 1000pF$	-	18	-	ns
Fall Time	$C_{OUT} = 1000pF$	-	18	-	ns
POWER GOOD AND CONTROL FUNCTIONS					
PGOOD LOW Level Voltage	Pull-up = $100k\Omega$	-	0.1	0.5	V
PGOOD Leakage Current		-	-	± 1.0	μA
PGOOD Upper Threshold, PWM 1 and 2	Fraction of set point	105	-	120	%
PGOOD Lower Threshold, PWM 1 and 2	Fraction of set point	80	-	95	%
ISEN and CURRENT LIMIT					
Full Scale Input Current (Note 8)		-	32	-	μA
Overcurrent Threshold (Note 8)	$ROCSET = 110k\Omega$	-	64	-	μA
OCSET (Current Limit) Voltage		-	1.75	-	V
SOFT-START					
Soft-Start Current		-	5	-	μA
PROTECTION					
Thermal Shutdown	Rising	-	150	-	$^\circ C$
	Hysteresis	-	20	-	$^\circ C$

NOTES:

- In normal operation, where the device is supplied with voltage on the V_{IN} pin, the VCC_5V pin provides a 5V output capable of 60mA (min). When the VCC_5V pin is used as a 5V supply input, the internal LDO regulator is disabled and the V_{IN} input pin must be connected to the VCC_5V pin. (Refer to the “Pin Descriptions” on page 8 for more details.)
- This is the total shutdown current with $V_{IN} = VCC_5V = PVCC = 5V$.
- Operating current is the supply current consumed when the device is active but not switching. It does not include gate drive current.
- The peak-to-peak sawtooth amplitude is production tested at 12V only; at 5V this parameter is guaranteed by design.
- Limits should be considered typical and are not production tested.
- Limits established by characterization and are not production tested.
- Established by characterization. The full scale current of $32\mu A$ is recommended for optimum current sample and hold operation. See “Feedback Loop Compensation” on page 11.

Typical Performance Curves

Oscilloscope plots are taken using the ISL6445EVAL Evaluation Board.

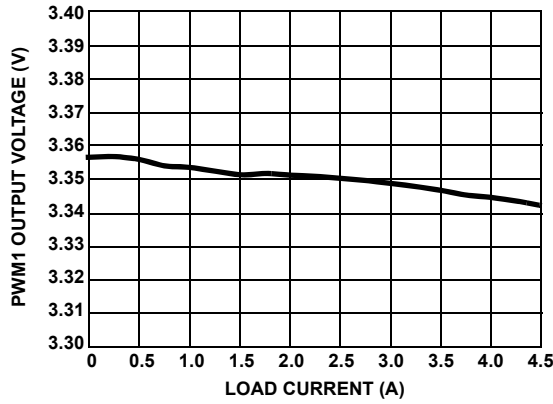

FIGURE 1. PWM1 LOAD REGULATION

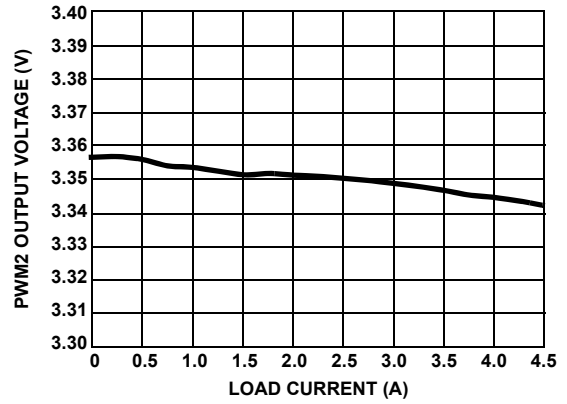

FIGURE 2. PWM2 LOAD REGULATION

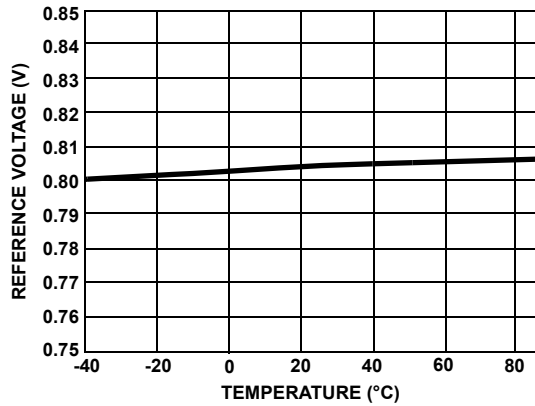

FIGURE 3. REFERENCE VOLTAGE VARIATION OVER TEMPERATURE

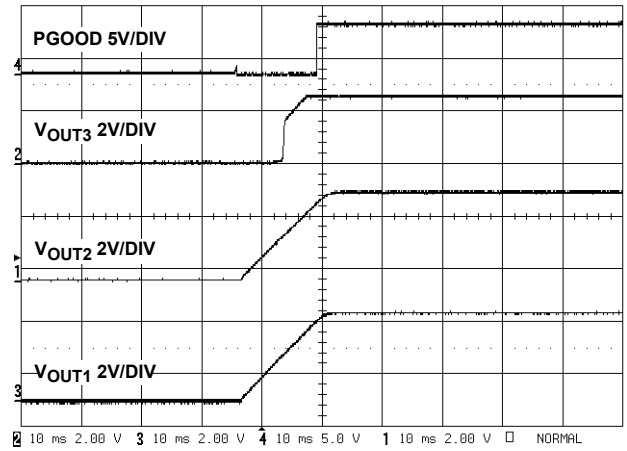

FIGURE 4. SOFT-START WAVEFORMS WITH PGOOD

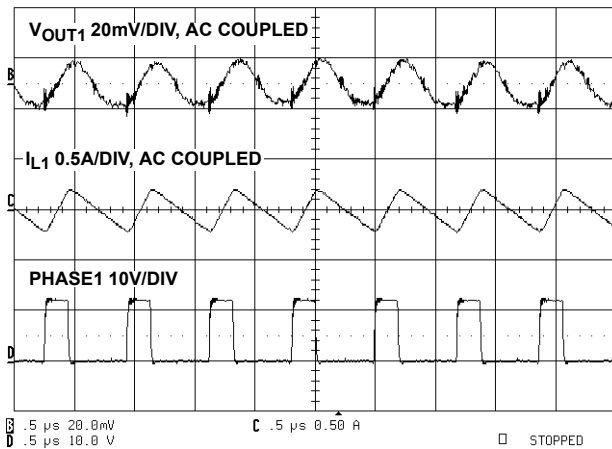

FIGURE 5. PWM1 WAVEFORMS

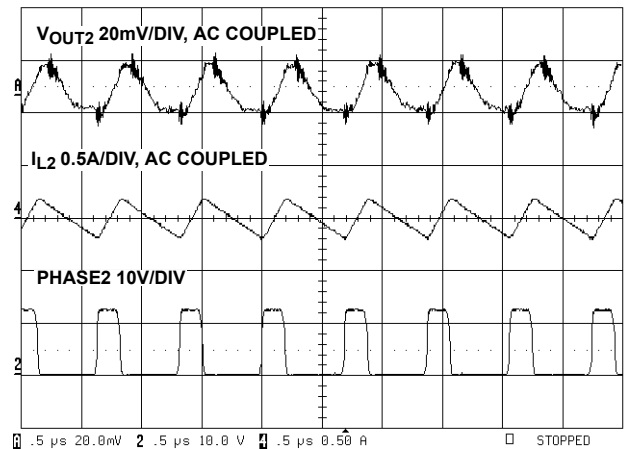

FIGURE 6. PWM2 WAVEFORMS

Typical Performance Curves

Oscilloscope plots are taken using the ISL6445EVAL Evaluation Board.

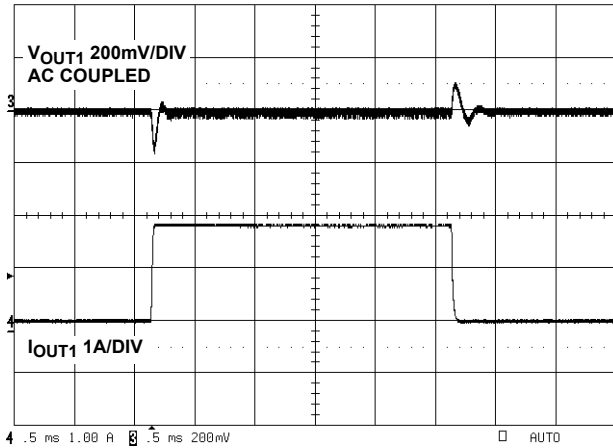

FIGURE 7. LOAD TRANSIENT RESPONSE V_{OUT1} (3.3V)

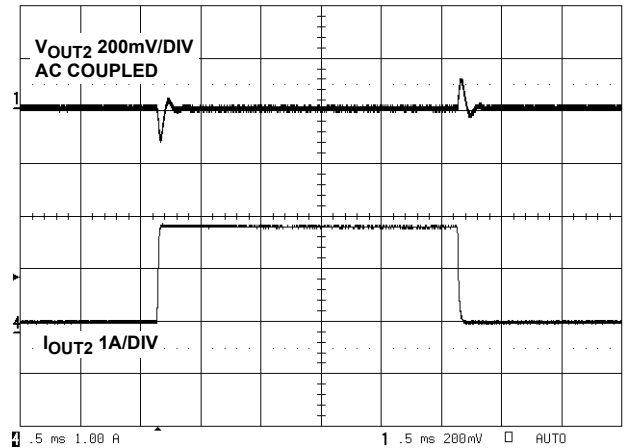

FIGURE 8. LOAD TRANSIENT RESPONSE V_{OUT2} (1.2V)

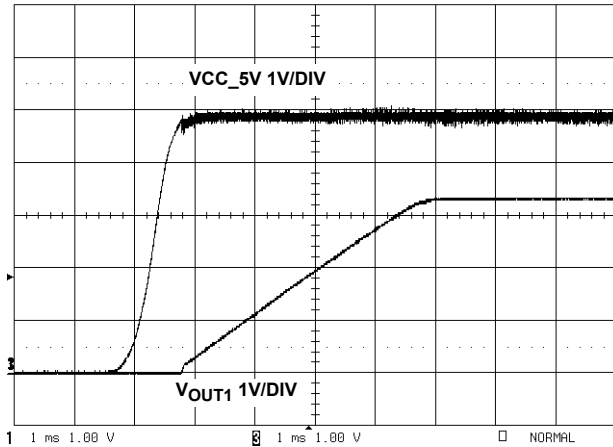

FIGURE 9. PWM SOFT-START WAVEFORM

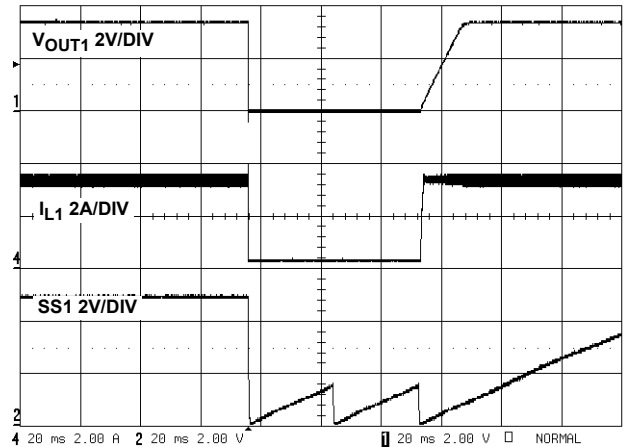

FIGURE 10. OVERCURRENT HICCUP MODE OPERATION

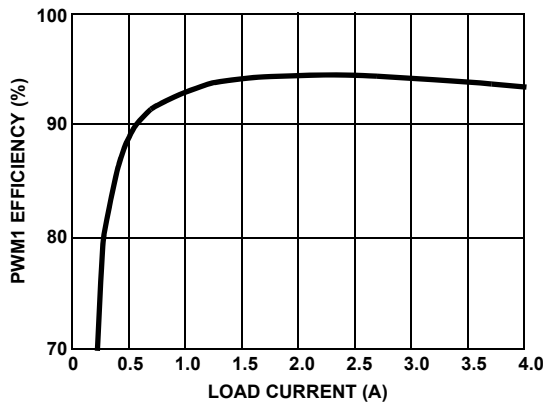

FIGURE 11. PWM1 EFFICIENCY vs LOAD (3.3V), $V_{IN} = 5V$

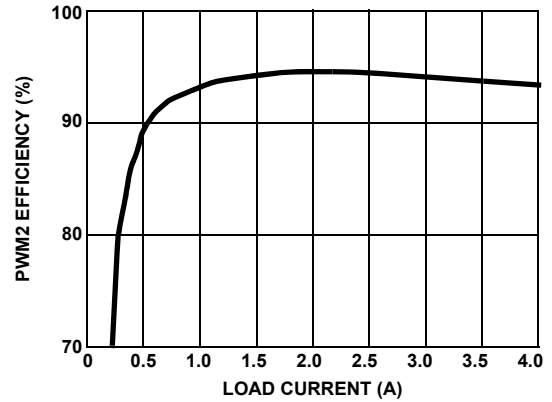

FIGURE 12. PWM2 EFFICIENCY vs LOAD (3.3V), $V_{IN} = 5V$

Pin Descriptions

BOOT2, BOOT1 - These pins power the upper MOSFET drivers of each PWM converter. Connect this pin to the junction of the bootstrap capacitor and the cathode of the bootstrap diode. The anode of the bootstrap diode is connected to the VCC_5V pin.

UGATE2, UGATE1 - These pins provide the gate drive for the upper MOSFETs.

PHASE2, PHASE1 - These pins are connected to the junction of the upper MOSFETs source, output filter inductor and lower MOSFETs drain.

LGATE2, LGATE1 - These pins provide the gate drive for the lower MOSFETs.

PGND - This pin provides the power ground connection for the lower gate drivers for both PWM1 and PWM2. This pin should be connected to the sources of the lower MOSFETs and the (-) terminals of the external input capacitors.

FB2, FB1 - These pins are connected to the feedback resistor divider and provide the voltage feedback signals for the respective controller. They set the output voltage of the converter. In addition, the PGOOD circuit uses these inputs to monitor the output voltage status.

ISEN2, ISEN1 - These pins are used to monitor the voltage drop across the lower MOSFET for current loop feedback and overcurrent protection.

PGOOD - This is an open drain logic output used to indicate the status of the output voltages. This pin is pulled low when either of the two PWM outputs is not within 10% of the respective nominal voltage.

SGND - This is the small-signal ground, common to both controllers, and must be routed separately from the high current ground (PGND). All voltage levels are measured with respect to this pin. Connect the additional SGND pins to this pin.

VIN - Use this pin to power the device with an external supply voltage with a range of 5.6V to 24V. For 5V \pm 10% operation, connect this pin to VCC5.

VCC5 - This pin is the output of the internal +5V linear regulator. This output supplies the bias for the IC, the low side gate drivers, and the external boot circuitry for the high side gate drivers. The IC may be powered directly from a single 5V (\pm 10%) supply at this pin. When used as a 5V supply input, this pin must be externally connected to V_{IN}. The VCC5 pin must be always decoupled to power ground with a recommended minimum of 4.7 μ F ceramic capacitor, placed very close to the pin.

BIAS - This pin must be connected directly to VCC5.

SS1, SS2 - These pins provide a soft-start function for their respective PWM controllers. When the chip is enabled, the

regulated 5 μ A pull-up current source charges the capacitor connected from this pin to ground. The error amplifier reference voltage ramps from 0V to 0.8V while the voltage on the soft-start pin ramps from 0V to 0.8V.

SD1, SD2 - These pins provide an enable/disable function for their respective PWM output. The output is enabled when this pin is floating or pulled HIGH, and disabled when the pin is pulled LOW.

OCSET2, OCSET1 - A resistor from this pin to ground sets the overcurrent threshold for the respective PWM.

Functional Description

General Description

The ISL6445 integrates control circuits for two synchronous buck converters. The two synchronous bucks operate 180 degrees out of phase to substantially reduce the input ripple and thus reduce the input filter requirements. The chip has four control lines (SS1, SD1, SS2, and SD2), which provide independent control for each of the synchronous buck outputs.

The PWM controllers employ a free-running frequency of 1.4MHz. The current mode control scheme with an input voltage feed-forward ramp input to the modulator provides excellent rejection of input voltage variations and provides simplified loop compensation.

Internal 5V Linear Regulator (VCC5)

All ISL6445 functions are internally powered from an on-chip, low dropout, +5V regulator. The maximum regulator input voltage is 24V. Bypass the regulator's output (VCC5) with a 4.7 μ F capacitor to ground. The dropout voltage for this LDO is typically 600mV, so when V_{IN} is greater than 5.6V, VCC5 is +5V. The ISL6445 also employs an undervoltage lockout circuit that disables both regulators when VCC5 falls below 4.4V.

The internal LDO can source over 60mA to supply the IC, power the low side gate drivers, charge the external boot capacitor and supply small external loads. When driving large FETs, little or no regulator current may be available for external loads.

For example, a single large FET with 30nC total gate charge requires 30nC x 1.4MHz = 42mA. Thus four total FETs would require 36mA. With 3mA for the internal bias would leave approximately 20mA for an external +5V supply. Also, at higher input voltages with larger FETs, the power dissipation across the internal 5V will increase. Excessive dissipation across this regulator must be avoided to prevent junction temperature rise. Larger FETs can be used with 5V \pm 10% input applications. The thermal overload protection circuit will be triggered if the VCC5 output is short circuited. Connect VCC5 to V_{IN} for 5V \pm 10% input applications.

Soft-Start Operation

When soft-start is initiated, the voltage on the SS pin of the enabled PWM channels starts to ramp gradually, due to the 5 μ A current sourced into the external capacitor. The output voltage follows the soft-start voltage.

When the SS pin voltage reaches 0.8V, the output voltage of the enabled PWM channel reaches the regulation point, and the soft-start pin voltage continues to rise. At this point the PGOOD and fault circuitry is enabled. This completes the soft-start sequence. Any further rise of SS pin voltage does not affect the output voltage. By varying the values of the soft-start capacitors, it is possible to provide sequencing of the main outputs at start-up. The soft-start time can be obtained from Equation 1:

$$T_{SOFT} = 0.8V \left(\frac{C_{SS}}{5\mu A} \right) \quad (\text{EQ. 1})$$

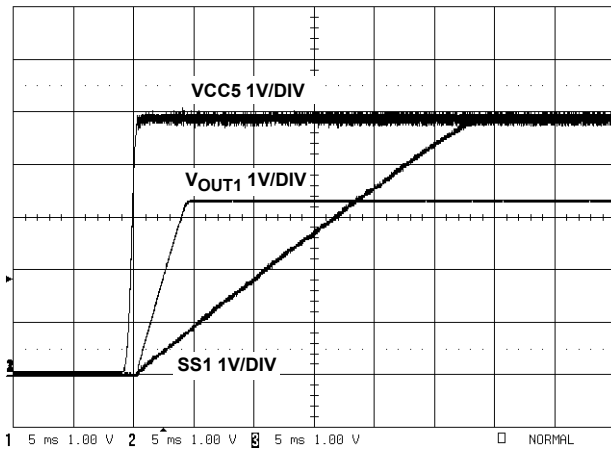

FIGURE 13. SOFT-START OPERATION

The soft-start capacitors can be chosen to provide startup tracking for the two PWM outputs. This can be achieved by choosing the soft-start capacitors such that the soft-start capacitor ratio equals the respective PWM output voltage ratio. For example, if I use PWM1 = 1.2V and PWM2 = 3.3V then the soft-start capacitor ratio should be, $C_{SS1}/C_{SS2} = 1.2/3.3 = 0.364$. Figure 14 shows that soft-start waveform with $C_{SS1} = 0.01\mu\text{F}$ and $C_{SS2} = 0.027\mu\text{F}$.

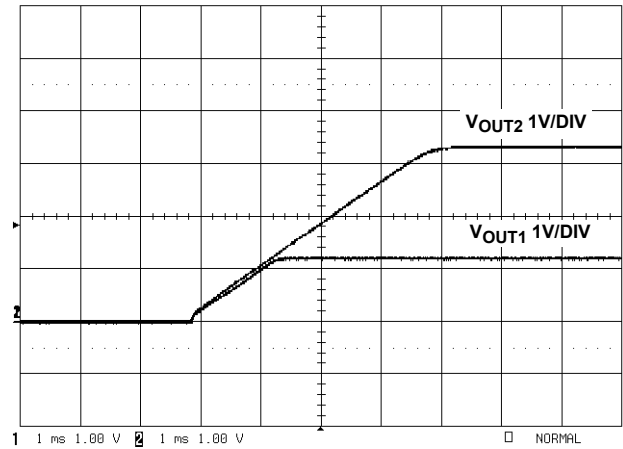

FIGURE 14. PWM1 AND PWM2 OUTPUT TRACKING DURING START-UP

Output Voltage Programming

A resistive divider from the output to ground sets the output voltage of either PWM channel. The center point of the divider shall be connected to FBx pin. The output voltage value is determined by Equation 2.

$$V_{OUTx} = 0.8V \left(\frac{R1 + R2}{R2} \right) \quad (\text{EQ. 2})$$

where R_1 is the top resistor of the feedback divider network and R_2 is the resistor connected from FB1 or FB2 to ground.

Out-of-Phase Operation

The two PWM controllers in the ISL6445 operate 180° out-of-phase to reduce input ripple current. This reduces the input capacitor ripple current requirements, reduces power supply-induced noise, and improves EMI. This effectively helps to lower component cost, save board space and reduce EMI.

Dual PWMs typically operate in-phase and turn on both upper FETs at the same time. The input capacitor must then support the instantaneous current requirements of both controllers simultaneously, resulting in increased ripple voltage and current. The higher RMS ripple current lowers the efficiency due to the power loss associated with the ESR of the input capacitor. This typically requires more low-ESR capacitors in parallel to minimize the input voltage ripple and ESR-related losses, or to meet the required ripple current rating.

With dual synchronized out-of-phase operation, the high-side MOSFETs of the ISL6445 turn on 180° out-of-phase. The instantaneous input current peaks of both regulators no longer overlap, resulting in reduced RMS ripple current and input voltage ripple. This reduces the required input capacitor ripple current rating, allowing fewer or less expensive capacitors, and reducing the shielding requirements for EMI. The typical operating curves show the synchronized 180° out-of-phase operation.

Input Voltage Range

The ISL6445 is designed to operate from input supplies ranging from 4.5V to 24V. However, the input voltage range can be effectively limited by the available maximum duty cycle ($D_{MAX} = 71\%$).

$$V_{IN(min)} = \left(\frac{V_{OUT} + V_{d1}}{0.71} \right) + V_{d2} - V_{d1} \quad (\text{EQ. 3})$$

where,

V_{d1} = Sum of the parasitic voltage drops in the inductor discharge path, including the lower FET, inductor and PC board.

V_{d2} = Sum of the voltage drops in the charging path, including the upper FET, inductor and PC board resistances.

The maximum input voltage and minimum output voltage is limited by the minimum on-time ($t_{ON(min)}$).

$$V_{IN(max)} \leq \frac{V_{OUT}}{t_{ON(min)} \times 1.4\text{MHz}} \quad (\text{EQ. 4})$$

where, $t_{ON(min)} = 30\text{ns}$

Gate Control Logic

The gate control logic translates generated PWM signals into gate drive signals providing amplification, level shifting and shoot-through protection. The gate drivers have some circuitry that helps optimize the ICs performance over a wide range of operational conditions. As MOSFET switching times can vary dramatically from type to type and with input voltage, the gate control logic provides adaptive dead time by monitoring real gate waveforms of both the upper and the lower MOSFETs. Shoot-through control logic provides a 20ns deadtime to ensure that both the upper and lower MOSFETs will not turn on simultaneously and cause a shoot-through condition.

Gate Drivers

The low-side gate driver is supplied from VCC5 and provides a peak sink/source current of 400mA. The high-side gate driver is also capable of 400mA current. Gate-drive voltages for the upper N-Channel MOSFET are generated by the flying capacitor boot circuit. A boot capacitor connected from the BOOT pin to the PHASE node provides power to the high side MOSFET driver. To limit the peak current in the IC, an external resistor may be placed between the UGATE pin and the gate of the external MOSFET. This small series resistor also damps any oscillations caused by the resonant tank of the parasitic inductances in the traces of the board and the FET's gate to drain capacitance.

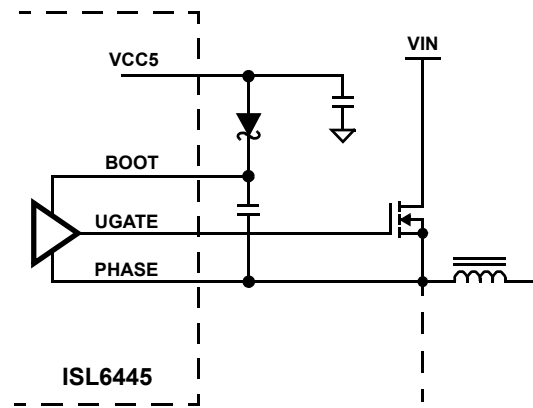

FIGURE 15. GATE DRIVER

At start-up the low-side MOSFET turns on and forces PHASE to ground in order to charge the BOOT capacitor to 5V. After the low-side MOSFET turns off, the high-side MOSFET is turned on by closing an internal switch between BOOT and UGATE. This provides the necessary gate-to-source voltage to turn on the upper MOSFET, an action that boosts the 5V gate drive signal above V_{IN} . The current required to drive the upper MOSFET is drawn from the internal 5V regulator.

Protection Circuits

The converter output is monitored and protected against overload, short circuit and undervoltage conditions. A sustained overload on the output sets the PGOOD low and initiates hiccup mode.

Both PWM controllers use the lower MOSFET's ON-resistance, $r_{DS(ON)}$, to monitor the current in the converter. The sensed voltage drop is compared with a threshold set by a resistor connected from the OCSETx pin to ground.

$$R_{OCSET} = \frac{(7)(R_{CS})}{(I_{OC})(r_{DS(ON)})} \quad (\text{EQ. 5})$$

where, I_{OC} is the desired overcurrent protection threshold, and R_{CS} is a value of the current sense resistor connected to the ISENx pin. If the lower MOSFET current exceeds the overcurrent threshold, an overcurrent condition is detected. If overcurrent is detected for 2 consecutive clock cycles then the IC enters a hiccup mode by turning off the gate drivers and entering into soft-start. The IC will cycle 2x through soft-start before trying to restart. The IC will continue to cycle through soft-start until the overcurrent condition is removed.

Because of the nature of this current sensing technique, and to accommodate a wide range of $r_{DS(ON)}$ variations, the value of the overcurrent threshold should represent an overload current about 150% to 180% of the maximum operating current. If more accurate current protection is desired place a current sense resistor in series with the lower MOSFET source.

Over-Temperature Protection

The IC incorporates an over-temperature protection circuit that shuts the IC down when a die temperature of +150°C is reached. Normal operation resumes when the die temperatures drops below +130°C through the initiation of a full soft-start cycle.

Feedback Loop Compensation

To reduce the number of external components and to simplify the process of determining compensation components, both PWM controllers have internally compensated error amplifiers. To make internal compensation possible several design measures were taken.

First, the ramp signal applied to the PWM comparator is proportional to the input voltage provided via the VIN pin. This keeps the modulator gain constant with variation in the input voltage. Second, the load current proportional signal is derived from the voltage drop across the lower MOSFET during the PWM time interval and is subtracted from the amplified error signal on the comparator input. This creates an internal current control loop. The resistor connected to the ISEN pin sets the gain in the current feedback loop. Equation 6 estimates the required value of the current sense resistor depending on the maximum operating load current and the value of the MOSFET's $r_{DS(ON)}$.

$$R_{CS} \geq \frac{(I_{MAX})(r_{DS(ON)})}{32\mu A} \tag{EQ. 6}$$

Choosing R_{CS} to provide 32μA of current to the current sample and hold circuitry is recommended but values down to 2μA and up to 100μA can be used.

Due to the current loop feedback, the modulator has a single pole response with -20dB slope at a frequency determined by the load.

$$F_{PO} = \frac{1}{2\pi \cdot R_O \cdot C_O} \tag{EQ. 7}$$

where R_O is load resistance and C_O is load capacitance. For this type of modulator, a Type 2 compensation circuit is usually sufficient.

Figure 16 shows a Type 2 amplifier and its response along with the responses of the current mode modulator and the converter. The Type 2 amplifier, in addition to the pole at origin, has a zero-pole pair that causes a flat gain region at frequencies in between the zero and the pole.

$$F_Z = \frac{1}{2\pi \cdot R_2 \cdot C_1} = 6kHz \tag{EQ. 8}$$

$$F_P = \frac{1}{2\pi \cdot R_1 \cdot C_2} = 600kHz \tag{EQ. 9}$$

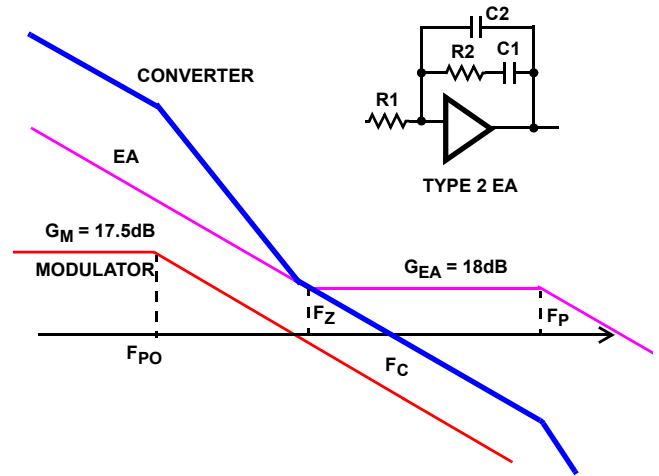

FIGURE 16. FEEDBACK LOOP COMPENSATION

The zero frequency, the amplifier high-frequency gain, and the modulator gain are chosen to satisfy most typical applications. The crossover frequency will appear at the point where the modulator attenuation equals the amplifier high frequency gain. The only task that the system designer has to complete is to specify the output filter capacitors to position the load main pole somewhere within one decade lower than the amplifier zero frequency. With this type of compensation plenty of phase margin is easily achieved due to zero-pole pair phase 'boost'.

Conditional stability may occur only when the main load pole is positioned too much to the left side on the frequency axis due to excessive output filter capacitance. In this case, the ESR zero placed within the 1.2kHz to 30kHz range gives some additional phase 'boost'. Some phase boost can also be achieved by connecting capacitor C_Z in parallel with the upper resistor R_1 of the divider that sets the output voltage value. Please refer to the "Output Inductor" and "Capacitor Selection" on page 13 for further details.

Layout Guidelines

Careful attention to layout requirements is necessary for successful implementation of a ISL6445 based DC/DC converter. The ISL6445 switches at a very high frequency and therefore the switching times are very short. At these switching frequencies, even the shortest trace has significant impedance. Also the peak gate drive current rises significantly in extremely short time. Transition speed of the current from one device to another causes voltage spikes across the interconnecting impedances and parasitic circuit elements. These voltage spikes can degrade efficiency, generate EMI, increase device overvoltage stress and ringing. Careful component selection and proper PC board layout minimizes the magnitude of these voltage spikes.

There are two sets of critical components in a DC/DC converter using the ISL6445. The switching power components and the small signal components. The switching power components are the most critical from a layout point of view because they switch a large amount of energy so they tend to generate a large amount of noise. The critical small signal components are those connected to sensitive nodes or those supplying critical bias currents. A multi-layer printed circuit board is recommended.

Layout Considerations

1. The Input capacitors, Upper FET, Lower FET, Inductor and Output capacitor should be placed first. Isolate these power components on the topside of the board with their ground terminals adjacent to one another. Place the input high frequency decoupling ceramic capacitor very close to the MOSFETs. Making the gate traces as short and thick as possible will limit the parasitic inductance and reduce the level of dv/dt seen at the gate of the lower FETs when the upper FET turns on.
2. Use separate ground planes for power ground and small signal ground. Connect the SGND and PGND together close of the IC. Do not connect them together anywhere else.
3. The loop formed by Input capacitor, the top FET and the bottom FET must be kept as small as possible.
4. Insure the current paths from the input capacitor to the MOSFET; to the output inductor and output capacitor are as short as possible with maximum allowable trace widths.
5. Place The PWM controller IC close to lower FET. The LGATE connection should be short and wide. The IC can be best placed over a quiet ground area. Avoid switching ground loop current in this area.
6. Place VCC5 bypass capacitor very close to VCC5 pin of the IC and connect its ground to the PGND plane.
7. Place the gate drive components BOOT diode and BOOT capacitors together near controller IC.
8. The output capacitors should be placed as close to the load as possible. Use short wide copper regions to connect output capacitors to load to avoid inductance and resistances.
9. Use copper filled polygons or wide but short trace to connect junction of upper FET. Lower FET and output inductor. Also keep the PHASE node connection to the IC short. Do not unnecessary oversize the copper islands for PHASE node. Since the phase nodes are subjected to very high dv/dt voltages, the stray capacitor formed between these islands and the surrounding circuitry will tend to couple switching noise.
10. Route all high speed switching nodes away from the control circuitry.
11. Create separate small analog ground plane near the IC. Connect SGND pin to this plane. All small signal grounding paths including feedback resistors, current

limit setting resistors, SDx pull-down resistors should be connected to this SGND plane.

12. Ensure the feedback connection to output capacitor is short and direct.

Component Selection Guidelines

MOSFET Considerations

The logic level MOSFETs are chosen for optimum efficiency given the potentially wide input voltage range and output power requirements. Two N-Channel MOSFETs are used in each of the synchronous-rectified buck converters for the PWM1 and PWM2 outputs. These MOSFETs should be selected based upon $r_{DS(ON)}$, gate supply requirements, and thermal management considerations.

The power dissipation includes two loss components; conduction loss and switching loss. These losses are distributed between the upper and lower MOSFETs according to duty cycle (see Equations 10 and 11). The conduction losses are the main component of power dissipation for the lower MOSFETs. Only the upper MOSFET has significant switching losses, since the lower device turns on and off into near zero voltage. Equations 10 and 11 assume linear voltage-current transitions and do not model power loss due to the reverse-recovery of the lower MOSFET's body diode.

$$P_{UPPER} = \frac{(I_O)^2 (r_{DS(ON)}) (V_{OUT})}{V_{IN}} + \frac{(I_O)(V_{IN})(t_{SW})(F_{SW})}{2} \quad (\text{EQ. 10})$$

$$P_{LOWER} = \frac{(I_O)^2 (r_{DS(ON)}) (V_{IN} - V_{OUT})}{V_{IN}} \quad (\text{EQ. 11})$$

A large gate-charge increases the switching time, t_{SW} , which increases the upper MOSFET switching losses. Ensure that both MOSFETs are within their maximum junction temperature at high ambient temperature by calculating the temperature rise according to package thermal-resistance specifications.

As the input voltage increases the power dissipation in the internal +5V regulator increases. To ensure that the ISL6445 does not overheat choose the external MOSFETs based on the total FET gate charge according the Figure 17. The plot shows the maximum recommended gate charge for different maximum ambient operating temperatures.

The power dissipation across the internal LDO comes from the bias current for the chip as well as the current needed to supply the internal gate drivers that drive the external MOSFETs. The plot uses a recommended maximum operating junction temperature of +125°C and calculates the maximum gate charge based on the die temperature and the maximum drive current that the internal LDO can supply.

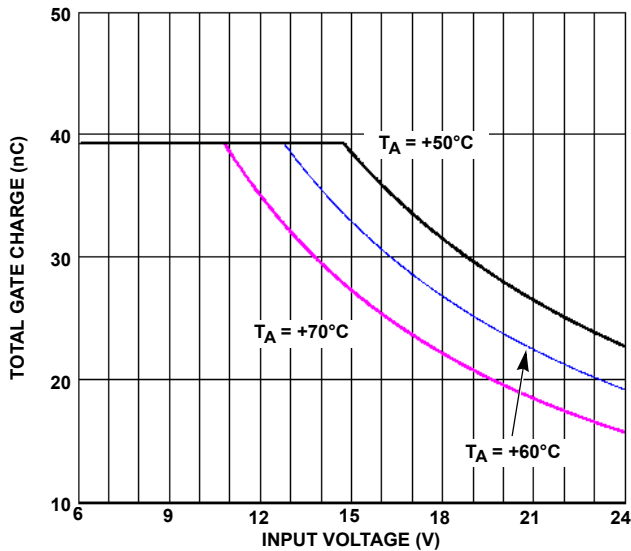

FIGURE 17. FET GATE CHARGE

Output Capacitor Selection

The output capacitors for each output have unique requirements. In general, the output capacitors should be selected to meet the dynamic regulation requirements including ripple voltage and load transients. Selection of output capacitors is also dependent on the output inductor, so some inductor analysis is required to select the output capacitors.

One of the parameters limiting the converter’s response to a load transient is the time required for the inductor current to slew to it’s new level. The ISL6445 will provide either 0% or 71% duty cycle in response to a load transient.

The response time is the time interval required to slew the inductor current from an initial current value to the load current level. During this interval the difference between the inductor current and the transient current level must be supplied by the output capacitor(s). Minimizing the response time can minimize the output capacitance required. Also, if the load transient rise time is slower than the inductor response time, as in a hard drive or CD drive, it reduces the requirement on the output capacitor.

The maximum capacitor value required to provide the full, rising step, transient load current during the response time of the inductor is:

$$C_{OUT} = \frac{(L_O)(I_{TRAN})^2}{2(V_{IN} - V_O)(DV_{OUT})} \tag{EQ. 12}$$

where, C_{OUT} is the output capacitor(s) required, L_O is the output inductor, I_{TRAN} is the transient load current step, V_{IN} is the input voltage, V_O is output voltage, and DV_{OUT} is the drop in output voltage allowed during the load transient.

High frequency capacitors initially supply the transient current and slow the load rate-of-change seen by the bulk capacitors. The bulk filter capacitor values are generally

determined by the ESR (Equivalent Series Resistance) and voltage rating requirements as well as actual capacitance requirements.

The output voltage ripple is due to the inductor ripple current and the ESR of the output capacitors as defined by Equation 13:

$$V_{RIPPLE} = \Delta I_L (ESR) \tag{EQ. 13}$$

where, I_L is calculated in the “Output Inductor Selection” on page 13.

High frequency decoupling capacitors should be placed as close to the power pins of the load as physically possible. Be careful not to add inductance in the circuit board wiring that could cancel the usefulness of these low inductance components. Consult with the manufacturer of the load circuitry for specific decoupling requirements.

Use only specialized low-ESR capacitors intended for switching-regulator applications at 1.4MHz for the bulk capacitors. In most cases, multiple small-case electrolytic capacitors perform better than a single large-case capacitor.

The stability requirement on the selection of the output capacitor is that the ‘ESR zero’, f_Z, be between 1.2kHz and 30kHz. This range is set by an internal, single compensation zero at 6kHz. The ESR zero can be a factor of five on either side of the internal zero and still contribute to increased phase margin of the control loop. Therefore,

$$C_{OUT} = \frac{1}{2\pi(ESR)(f_Z)} \tag{EQ. 14}$$

In conclusion, the output capacitors must meet three criteria:

1. They must have sufficient bulk capacitance to sustain the output voltage during a load transient while the output inductor current is slewing to the value of the load transient,
2. The ESR must be sufficiently low to meet the desired output voltage ripple due to the output inductor current, and
3. The ESR zero should be placed, in a rather large range, to provide additional phase margin.

The recommended output capacitor value for the ISL6445 is between 150µF to 680µF, to meet stability criteria with external compensation. Use of aluminum electrolytic, POSCAP, or tantalum type capacitors is recommended. Use of low ESR ceramic capacitors is possible but would take more rigorous loop analysis to ensure stability.

Output Inductor Selection

The PWM converters require output inductors. The output inductor is selected to meet the output voltage ripple requirements. The inductor value determines the converter’s ripple current and the ripple voltage is a function of the ripple current and output capacitor(s) ESR. The ripple voltage

expression is given in the capacitor selection section and the ripple current is approximated by Equation 15:

$$\Delta I_L = \frac{(V_{IN} - V_{OUT})(V_{OUT})}{(f_S)(L)(V_{IN})} \quad (\text{EQ. 15})$$

For the ISL6445, use Inductor values between 1µH to 3.3µH.

Input Capacitor Selection

The important parameters for the bulk input capacitor(s) are the voltage rating and the RMS current rating. For reliable operation, select bulk input capacitors with voltage and current ratings above the maximum input voltage and largest RMS current required by the circuit. The capacitor voltage rating should be at least 1.25x greater than the maximum input voltage and 1.5x is a conservative guideline. The AC RMS Input current varies with the load. The total RMS current supplied by the input capacitance is as shown in Equation 16:

$$I_{RMS} = \sqrt{I_{RMS1}^2 + I_{RMS2}^2} \quad (\text{EQ. 16})$$

where,

$$I_{RMSx} = \sqrt{DC - DC^2} \quad (\text{EQ. 17})$$

DC is duty cycle of the respective PWM.

Depending on the specifics of the input power and its impedance, most (or all) of this current is supplied by the input capacitor(s). Figure 18 shows the advantage of having the PWM converters operating out of phase. If the converters were operating in phase, the combined RMS current would be the algebraic sum, which is a much larger value as shown. The combined out-of-phase current is the square root of the sum of the square of the individual reflected currents and is significantly less than the combined in-phase current.

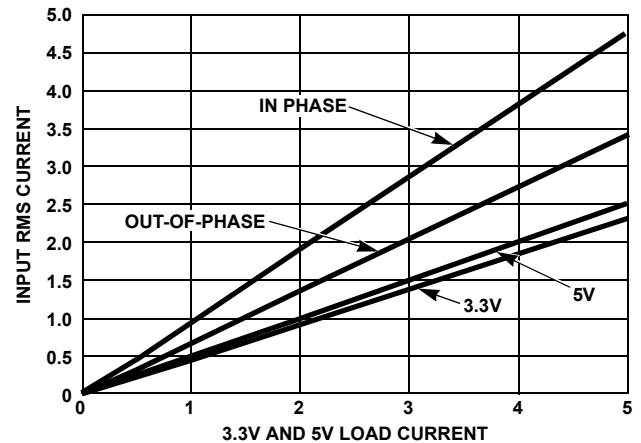

FIGURE 18. INPUT RMS CURRENT vs LOAD

Use a mix of input bypass capacitors to control the voltage ripple across the MOSFETs. Use ceramic capacitors for the high frequency decoupling and bulk capacitors to supply the RMS current. Small ceramic capacitors can be placed very close to the upper MOSFET to suppress the voltage induced in the parasitic circuit impedances.

For board designs that allow through-hole components, the Sanyo OS-CON® series offer low ESR and good temperature performance. For surface mount designs, solid tantalum capacitors can be used, but caution must be exercised with regard to the capacitor surge current rating. These capacitors must be capable of handling the surge-current at power-up. The TPS series available from AVX is surge current tested.

© Copyright Intersil Americas LLC 2005-2008. All Rights Reserved.

All trademarks and registered trademarks are the property of their respective owners.

For additional products, see www.intersil.com/en/products.html

Intersil products are manufactured, assembled and tested utilizing ISO9001 quality systems as noted in the quality certifications found at www.intersil.com/en/support/qualandreliability.html

Intersil products are sold by description only. Intersil may modify the circuit design and/or specifications of products at any time without notice, provided that such modification does not, in Intersil's sole judgment, affect the form, fit or function of the product. Accordingly, the reader is cautioned to verify that datasheets are current before placing orders. Information furnished by Intersil is believed to be accurate and reliable. However, no responsibility is assumed by Intersil or its subsidiaries for its use; nor for any infringements of patents or other rights of third parties which may result from its use. No license is granted by implication or otherwise under any patent or patent rights of Intersil or its subsidiaries.

For information regarding Intersil Corporation and its products, see www.intersil.com

**Shrink Small Outline Plastic Packages (SSOP)
Quarter Size Outline Plastic Packages (QSOP)**

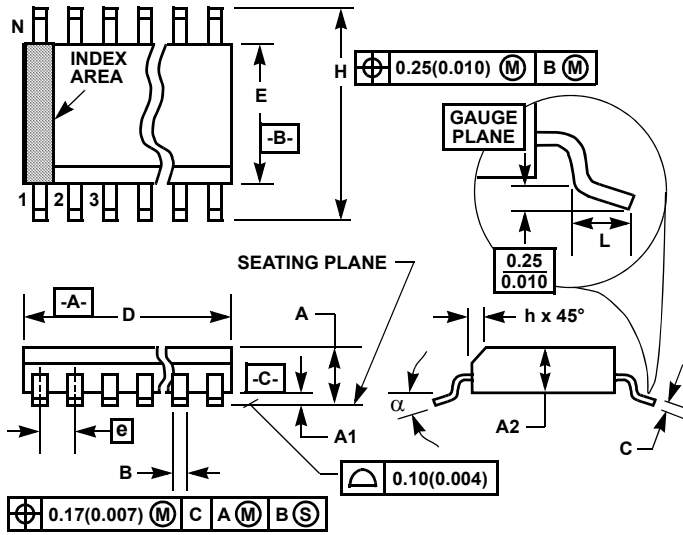

M24.15

**24 LEAD SHRINK SMALL OUTLINE PLASTIC PACKAGE
(0.150" WIDE BODY)**

SYMBOL	INCHES		MILLIMETERS		NOTES
	MIN	MAX	MIN	MAX	
A	0.053	0.069	1.35	1.75	-
A1	0.004	0.010	0.10	0.25	-
A2	-	0.061	-	1.54	-
B	0.008	0.012	0.20	0.30	9
C	0.007	0.010	0.18	0.25	-
D	0.337	0.344	8.55	8.74	3
E	0.150	0.157	3.81	3.98	4
e	0.025 BSC		0.635 BSC		-
H	0.228	0.244	5.80	6.19	-
h	0.0099	0.0196	0.26	0.49	5
L	0.016	0.050	0.41	1.27	6
N	24		24		7
α	0°	8°	0°	8°	-

Rev. 2 6/04

NOTES:

1. Symbols are defined in the "MO Series Symbol List" in Section 2.2 of Publication Number 95.
2. Dimensioning and tolerancing per ANSI Y14.5M-1982.
3. Dimension "D" does not include mold flash, protrusions or gate burrs. Mold flash, protrusion and gate burrs shall not exceed 0.15mm (0.006 inch) per side.
4. Dimension "E" does not include interlead flash or protrusions. Interlead flash and protrusions shall not exceed 0.25mm (0.010 inch) per side.
5. The chamfer on the body is optional. If it is not present, a visual index feature must be located within the crosshatched area.
6. "L" is the length of terminal for soldering to a substrate.
7. "N" is the number of terminal positions.
8. Terminal numbers are shown for reference only.
9. Dimension "B" does not include dambar protrusion. Allowable dambar protrusion shall be 0.10mm (0.004 inch) total in excess of "B" dimension at maximum material condition.
10. Controlling dimension: INCHES. Converted millimeter dimensions are not necessarily exact.

Looking for pricing, stock, or lifecycle information?

Click below to explore more details on WIN SOURCE:

 [View ISL6445IAZ-TK on WIN SOURCE](#)

 [Intersil Information](#)

Optimize Your Supply Chain with WIN SOURCE Solutions

-  Global Sourcing Solution
-  Obsolete Management
-  Cost Control Management
-  Shortage Management
-  Alternative Solution
-  Excess Inventory Management