



**THE DATASHEET OF
NCP5426SN13T2**



NCP5426

LDO Regulator/Vibration Motor Driver

The NCP5426 series of fixed output, 150 mA low dropout linear regulators are designed to be an economical solution for a variety of applications. Each device contains a voltage reference unit, an error amplifier, a PNP power transistor, resistors for setting output voltage, an under voltage lockout on the input, an enable pin, and current limit and temperature limit protection circuits.

The NCP5426 is designed for driving a vibration motor using ceramic capacitors on the output. The device is housed in the micro-miniature TSOP-5 surface mount package. The NCP5426 is available in output voltages of 1.2 V to 2.0 V in 0.1 V increments.

Features

- Wide Operating Voltage Range to 12 V
- Internally Set Output Voltages
- Enable Pin for On/Off Control
- UVLO on the Input Voltage with Hysteresis
- Current and Thermal Protection
- Compatible with Ceramic, Tantalum or Aluminum Electrolytic Capacitors
- Pb-Free Package is Available

Typical Applications

- Vibration Motor Driver

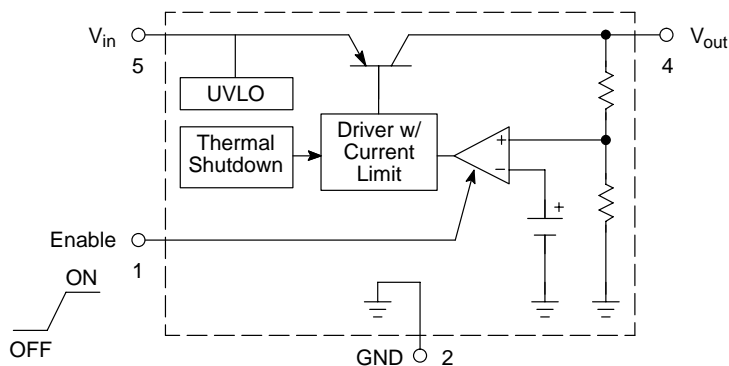

This device contains 47 active transistors.

Figure 1. Internal Schematic



ON Semiconductor®

<http://onsemi.com>



TSOP-5
SN SUFFIX
CASE 483

PIN CONNECTIONS AND MARKING DIAGRAM

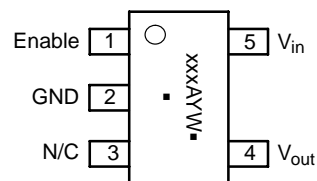

(Top View)

- xxx = Specific Device Code
 - A = Assembly Location
 - Y = Year
 - W = Work Week
 - = Pb-Free Package
- (Note: Microdot may be in either location)

ORDERING INFORMATION

See detailed ordering and shipping information in the package dimensions section on page 7 of this data sheet.

NCP5426

DETAILED PIN DESCRIPTION

Pin	Name	Description
1	Enable	The enable pin allows the user to control the output. A low signal disables the output and places the device into a low current standby mode.
2	GND	Ground pin.
3	N/C	This pin is not connected to the device.
4	V _{out}	Regulated output voltage.
5	V _{in}	Input voltage.

MAXIMUM RATINGS

Rating	Symbol	Value	Unit
Max Voltage, All Pins	V _{MAX}	12	V
Power Dissipation to Air	P _A	150	mW
Power Dissipation, Board Mounted	P	600	mW
Operating and Storage Temperature	T _A	-40 to 85	°C
Thermal Resistance	T _{JA}	300	°C/W
Junction Temperature	T _J	125	°C

Maximum ratings are those values beyond which device damage can occur. Maximum ratings applied to the device are individual stress limit values (not normal operating conditions) and are not valid simultaneously. If these limits are exceeded, device functional operation is not implied, damage may occur and reliability may be affected.

ELECTRICAL CHARACTERISTICS (T_A = 25°C, for min/max values T_A is the operating junction temperature that applies, V_{CC} = 3.5 V, unless otherwise noted)

Characteristic	Symbol	Min	Typ	Max	Unit
Operating Voltage	V _{CC}	-	-	12	V
Operating Voltage Turn On, I _{out} = 30 mA, Increasing V _{CC}	V _{CCON}	-	2.6	2.8	V
Operating Voltage Turn Off, I _{out} = 30 mA, Decreasing V _{CC}	V _{CCOFF}	2.0	2.1	2.2	V
Operating Voltage Hysteresis, I _{out} = 30 mA	V _{CC(hyst)}	400	500	600	mV
Operating Current No Load	I _{CC}	-	120	240	μA
Operating Current, V _{CC} = 1.8 V, Enable High	I _{CC(uvlo)}	-	80	160	μA
Operating Current, Enable Low	I _{CC(off)}	-	-	0.1	μA
Maximum Output Current, V _{out} = 0.95 * V _{nom}	I _{out(max)}	150	-	-	mA
Overcurrent Protection, V _{out} = 0 V	I _{out(limit)}	-	270	-	mA
Load Regulation, V _{in} = 3.5 V, I _{out} 1.0 to 100 mA	Reg _{load}	-	30	60	mV
Line Regulation, I _{out} = 30 mA, V _{in} 3.0 to 5.0 V	Reg _{line}	-	10	20	mV
Ripple Rejection, V _{in} 3.5 V, f 120 Hz, V _{pp} 1.0 V, I _{out} 30 mA	RR	55	70	-	dB
Temperature Shutdown	T _{std}	-	150	-	°C
V _{CC} Low Detector Temperature Coefficient, I _{out} = 30 mA, T = -40 to 85°C	ΔV _{CC} H to L/ΔT	-	200	-	ppm/°C
V _{out} Temperature Coefficient	ΔV _O /ΔT	-	100	-	ppm/°C
Enable Pin High Threshold	V _{eh}	1.6	-	-	V
Enable Pin Low Threshold	V _{el}	-	-	0.4	V
Enable Pin Current, V _e = 1.6 V	I _e	-	5.0	10	μA

-1.3 V

Output Voltage, I _{out} = 30 mA	V _{out}	1.261	1.3	1.339	V
--	------------------	-------	-----	-------	---

NCP5426

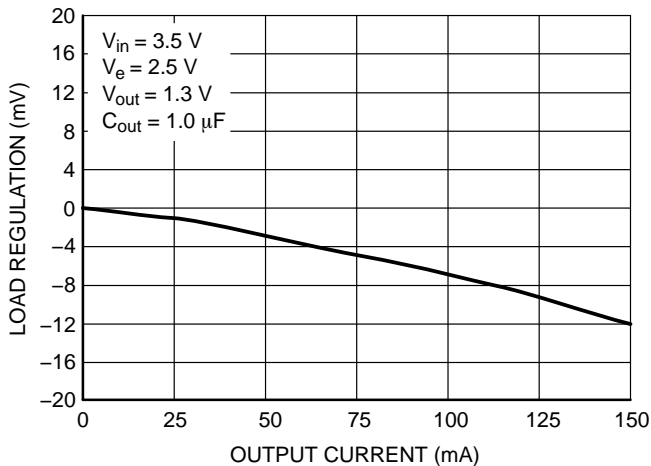

Figure 2. Load Regulation NCP5426

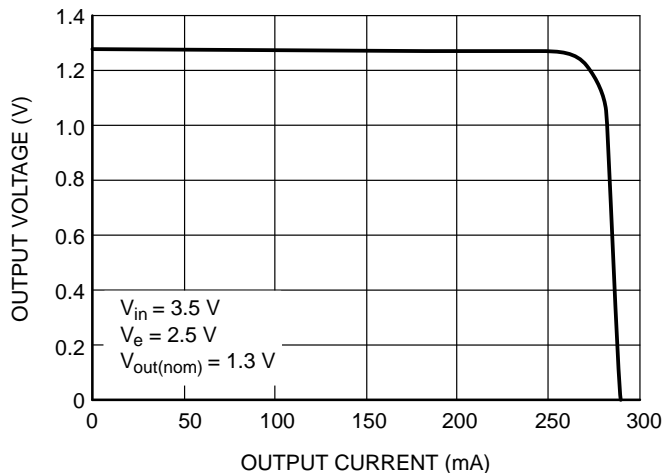

Figure 3. Current Limit NCP5426

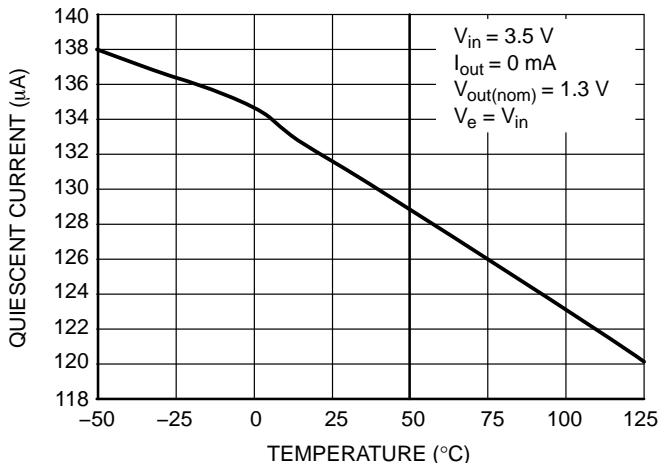

Figure 4. Quiescent Current vs. Temperature

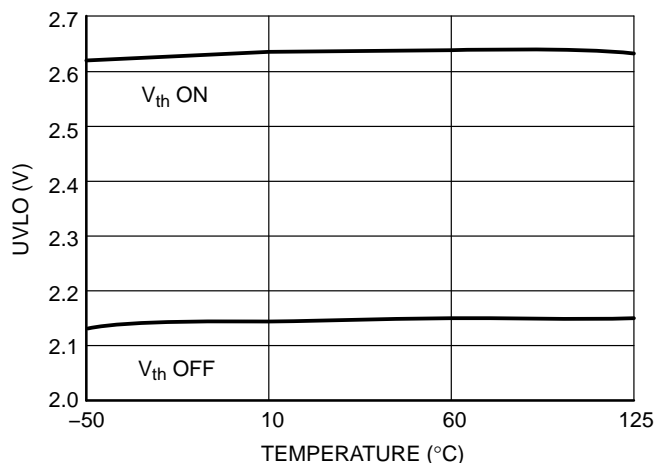

Figure 5. Undervoltage Lockout vs. Temperature

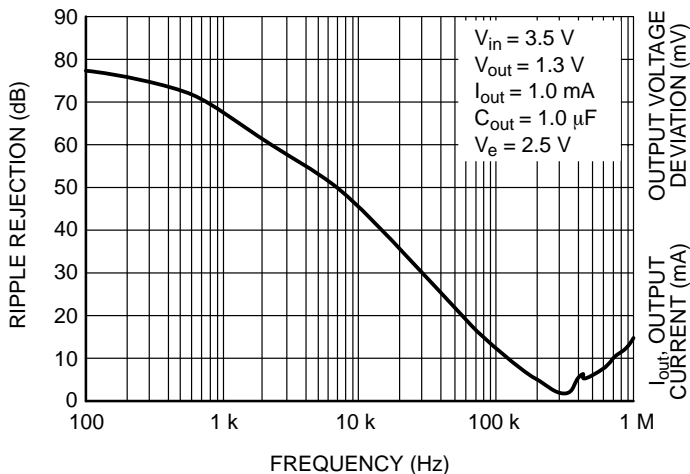

Figure 6. Ripple Rejection vs. Frequency

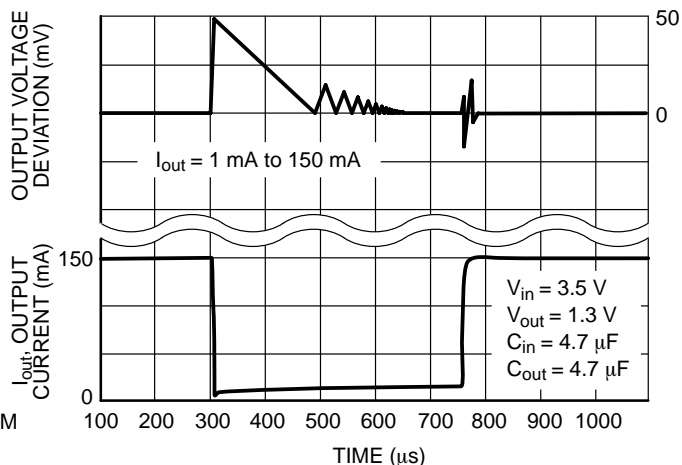

Figure 7. Load Transient Response

NCP5426

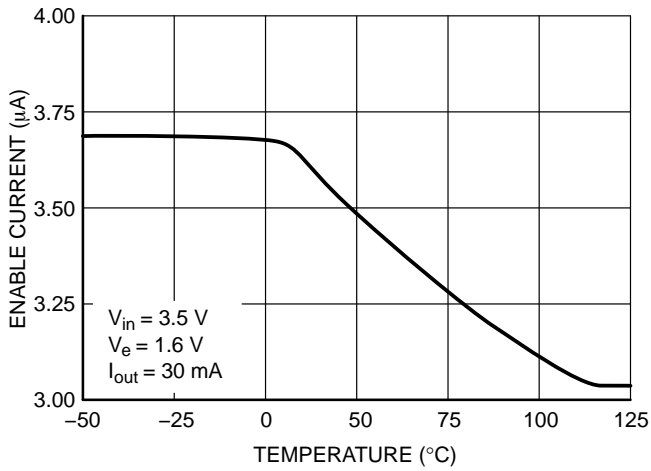

Figure 8. Enable Current vs. Temperature

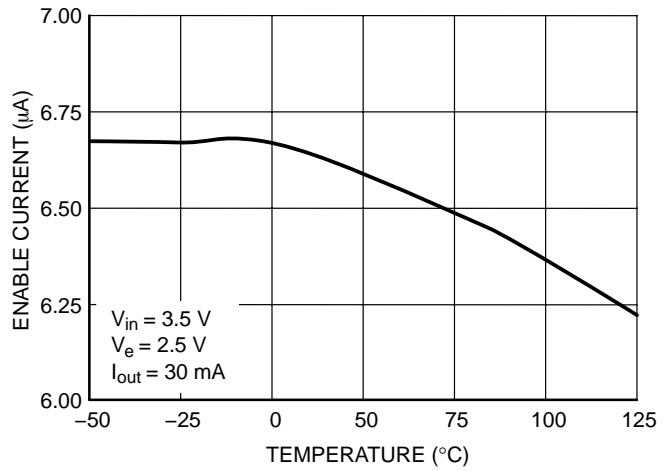

Figure 9. Enable Current vs. Temperature

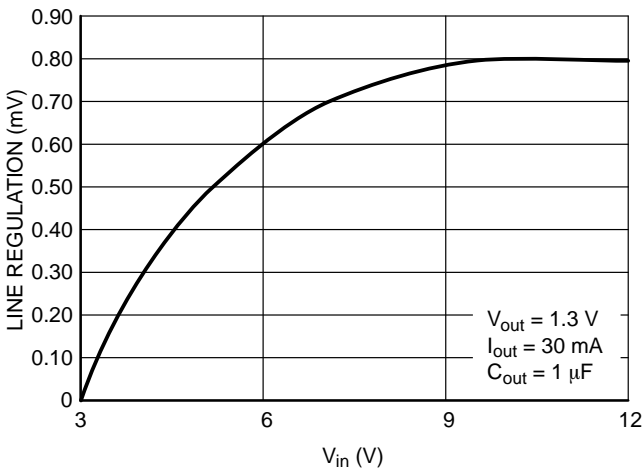

Figure 10. Line Regulation

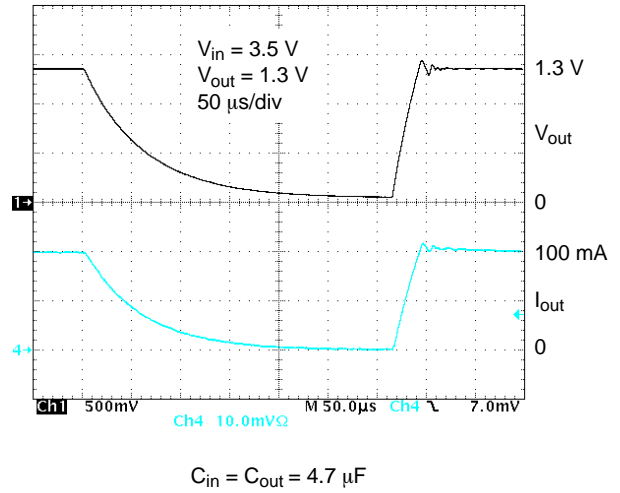

Figure 11. Resistive Transient Response for Switching the Enable Pin, $R_{out} = 13 \text{ Ohms}$

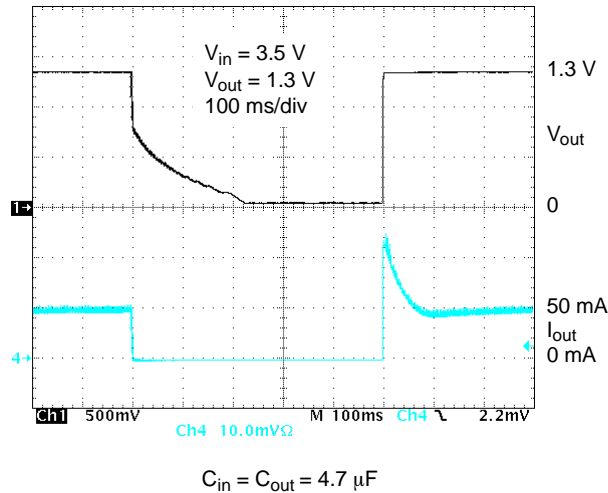

Figure 12. Transient Response for Switching the Enable Pin, Vibration Motor Load

DEFINITIONS

Load Regulation

The change in output voltage for a change in output load current at a constant temperature and input voltage.

Dropout Voltage

The input/output differential at which the regulator output no longer maintains regulation against further reductions in input voltage. Measured when the output drops 2.0% below its nominal. The junction temperature, load current, and minimum input supply requirements affect the dropout level.

Output Noise Voltage

This is the integrated value of the output noise over a specified frequency range. Input voltage and output load current are kept constant during the measurement. Results are expressed in μVRMS or $\text{nV}\sqrt{\text{Hz}}$.

Quiescent Current

The current which flows through the ground pin when the regulator operates without a load on its output: internal IC operation, bias, etc. When the LDO becomes loaded, this term is called the Ground current. It is actually the difference between the input current (measured through the LDO input pin) and the output current.

Line Regulation

The change in output voltage for a change in input voltage. The measurement is made under conditions of low dissipation or by using pulse technique such that the average chip temperature is not significantly affected.

Line Transient Response

Typical over and undershoot response when input voltage is excited with a given slope.

Thermal Protection

Internal thermal shutdown circuitry is provided to protect the integrated circuit in the event that the maximum junction temperature is exceeded. When activated at typically 150°C , the regulator turns off. This feature is provided to prevent failures from accidental overheating.

Maximum Package Power Dissipation

The power dissipation level at which the junction temperature reaches its maximum operating value, i.e. 125°C .

APPLICATIONS INFORMATION

The following description will assist the system designer to correctly use the NCP5426 in an application. The NCP5426 is designed specifically for use with inductive loads, typically Vibration Motors. The LDO is capable of using ceramic and tantalum capacitors. Please refer to Figure 13 for a typical system schematic.

Input Decoupling

A capacitor, C1, is necessary on the input for normal operation. A ceramic or tantalum capacitor with a minimum value of 1.0 μF is required. Higher values of capacitance and lower ESR will improve the overall line and load transient response.

Output Decoupling

A capacitor, C2, is required for the NCP5426 to operate normally. A ceramic or tantalum capacitor will suffice. The selection of the output capacitor is dependant upon several factors: output current, power up and down delays, inductive kickback during power up and down. It is recommended the output capacitor be as close to the output pin and ground pin for the best system response.

Enable Pin

The enable pin will turn on or off the regulator. The enable pin is active high. The internal input resistance of the enable pin is high which will keep the current very low when the pin is pulled high. A low threshold voltage permits the NCP5426 to operate directly from microprocessors or controllers.

Thermal

As power across the NCP5426 increases, it might become necessary to provide some thermal relief. The maximum power dissipation supported by the device is dependent upon board design and layout. Mounting pad configuration on the PCB, the board material and the ambient temperature effect the rate of junction temperature rise for the part. This is stating that when the NCP5426 has good thermal conductivity through the PCB, the junction temperature will be relatively low with high power dissipation applications.

The maximum dissipation the package can handle is given by:

$$PD = \frac{T_J(max) - T_A}{R_{\theta JA}}$$

T_J is not recommended to exceed 125°C. The NCP5426 can dissipate up to 400 mW @ 25°C. The power dissipated by the NCP5426 can be calculated from the following equation:

$$P_{tot} = [V_{in} * I_{GND} (I_{out})] + [V_{in} - V_{out}] * I_{out}$$

or

$$V_{inMAX} = \frac{P_{tot} + V_{out} * I_{out}}{I_{GND} + I_{out}}$$

If a 150 mA output current is needed then the ground current is extracted from the data sheet curves: 200 μA @ 150 mA. For an NCP5426SN18T1 (1.8 V), the maximum input voltage will then be 4.4 V, good for a 1 Cell Li-ion battery.

Hints

Please be sure the V_{in} and GND lines are sufficiently wide. When the impedance of these lines is high, there is a chance to pick up noise or cause the regulator to malfunction. Set external components, especially the output capacitor, as close as possible to the circuit, and make leads as short as possible.

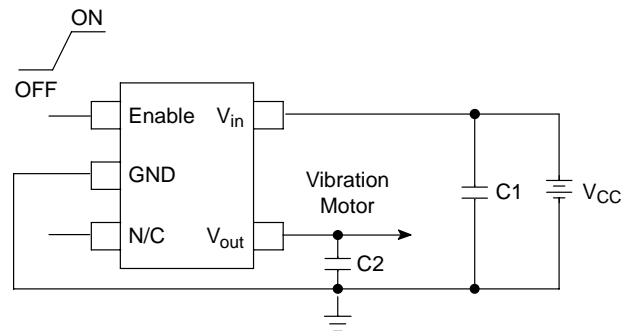

Figure 13. Typical Applications Circuit for Driving a Vibration Motor

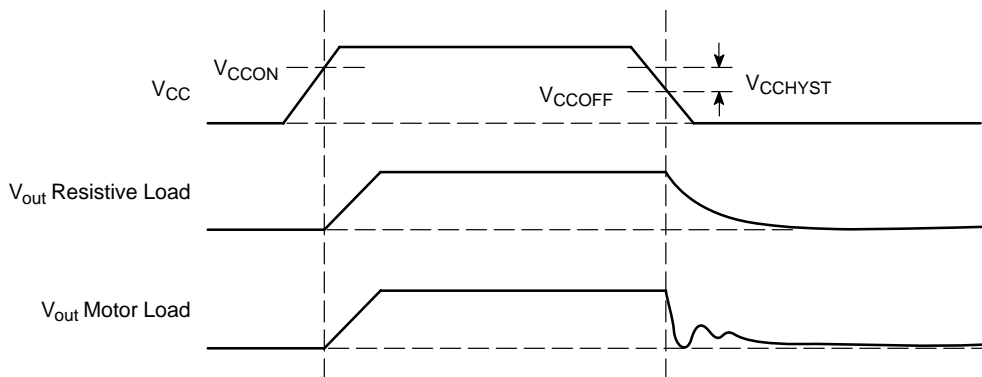

Figure 14. Timing Diagram

NCP5426

ORDERING INFORMATION

Device	Nominal Output Voltage*	Marking	Package	Shipping†
NCP5426SN13T1	1.3	LDZ	TSOP-5	3000 / Tape & Reel
NCP5426SN13T1G			TSOP-5 (Pb-Free)	
NCP5426SN13T2			TSOP-5	
NCP5426SN13T2G			TSOP-5 (Pb-Free)	

†For information on tape and reel specifications, including part orientation and tape sizes, please refer to our Tape and Reel Packaging Specifications Brochure, BRD8011/D.

*Contact your ON Semiconductor sales representative for other Output Voltage options.

NCP5426

PACKAGE DIMENSIONS

THIN SOT-23-5/TSOP-5/SC59-5
SN SUFFIX
CASE 483-02
ISSUE E

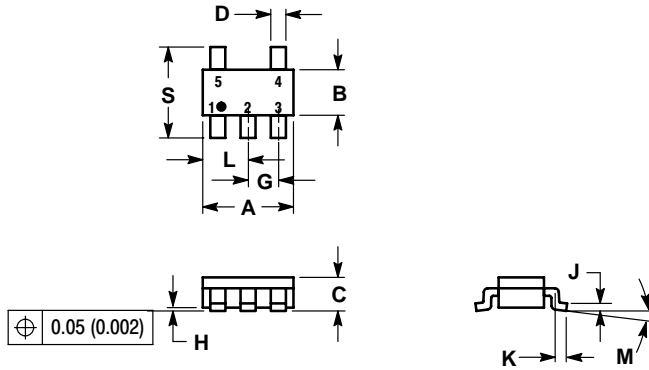

NOTES:

1. DIMENSIONING AND TOLERANCING PER ANSI Y14.5M, 1982.
2. CONTROLLING DIMENSION: MILLIMETER.
3. MAXIMUM LEAD THICKNESS INCLUDES LEAD FINISH THICKNESS. MINIMUM LEAD THICKNESS IS THE MINIMUM THICKNESS OF BASE MATERIAL.
4. A AND B DIMENSIONS DO NOT INCLUDE MOLD FLASH, PROTRUSIONS, OR GATE BURRS.

DIM	MILLIMETERS		INCHES	
	MIN	MAX	MIN	MAX
A	2.90	3.10	0.1142	0.1220
B	1.30	1.70	0.0512	0.0669
C	0.90	1.10	0.0354	0.0433
D	0.25	0.50	0.0098	0.0197
G	0.85	1.05	0.0335	0.0413
H	0.013	0.100	0.0005	0.0040
J	0.10	0.26	0.0040	0.0102
K	0.20	0.60	0.0079	0.0236
L	1.25	1.55	0.0493	0.0610
M	0°	10°	0°	10°
S	2.50	3.00	0.0985	0.1181

SOLDERING FOOTPRINT*

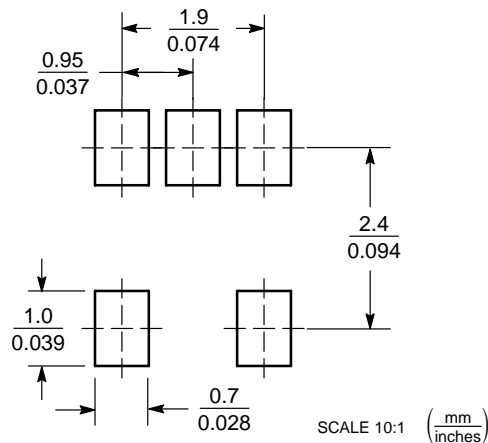

*For additional information on our Pb-Free strategy and soldering details, please download the ON Semiconductor Soldering and Mounting Techniques Reference Manual, SOLDERRM/D.

ON Semiconductor and are registered trademarks of Semiconductor Components Industries, LLC (SCILLC). SCILLC reserves the right to make changes without further notice to any products herein. SCILLC makes no warranty, representation or guarantee regarding the suitability of its products for any particular purpose, nor does SCILLC assume any liability arising out of the application or use of any product or circuit, and specifically disclaims any and all liability, including without limitation special, consequential or incidental damages. "Typical" parameters which may be provided in SCILLC data sheets and/or specifications can and do vary in different applications and actual performance may vary over time. All operating parameters, including "Typicals" must be validated for each customer application by customer's technical experts. SCILLC does not convey any license under its patent rights nor the rights of others. SCILLC products are not designed, intended, or authorized for use as components in systems intended for surgical implant into the body, or other applications intended to support or sustain life, or for any other application in which the failure of the SCILLC product could create a situation where personal injury or death may occur. Should Buyer purchase or use SCILLC products for any such unintended or unauthorized application, Buyer shall indemnify and hold SCILLC and its officers, employees, subsidiaries, affiliates, and distributors harmless against all claims, costs, damages, and expenses, and reasonable attorney fees arising out of, directly or indirectly, any claim of personal injury or death associated with such unintended or unauthorized use, even if such claim alleges that SCILLC was negligent regarding the design or manufacture of the part. SCILLC is an Equal Opportunity/Affirmative Action Employer. This literature is subject to all applicable copyright laws and is not for resale in any manner.

PUBLICATION ORDERING INFORMATION

LITERATURE FULFILLMENT:
Literature Distribution Center for ON Semiconductor
P.O. Box 61312, Phoenix, Arizona 85082-1312 USA
Phone: 480-829-7710 or 800-344-3860 Toll Free USA/Canada
Fax: 480-829-7709 or 800-344-3867 Toll Free USA/Canada
Email: orderlit@onsemi.com

N. American Technical Support: 800-282-9855 Toll Free
USA/Canada

Japan: ON Semiconductor, Japan Customer Focus Center
2-9-1 Kamimeguro, Meguro-ku, Tokyo, Japan 153-0051
Phone: 81-3-5773-3850

ON Semiconductor Website: <http://onsemi.com>

Order Literature: <http://www.onsemi.com/litorder>

For additional information, please contact your local Sales Representative.

Looking for pricing, stock, or lifecycle information?

Click below to explore more details on WIN SOURCE:

 [View NCP5426SN13T2 on WIN SOURCE](#)

 [ON Semiconductor](#) Information

Optimize Your Supply Chain with WIN SOURCE Solutions

-  Global Sourcing Solution
-  Obsolete Management
-  Cost Control Management
-  Shortage Management
-  Alternative Solution
-  Excess Inventory Management