



**THE DATASHEET OF  
FAN53555UC18X**



# FAN53555

## 5 A, 2.4 MHz, Digitally Programmable TinyBuck® Regulator



ON Semiconductor®

[www.onsemi.com](http://www.onsemi.com)

### Description

The FAN53555 is a step-down switching voltage regulator that delivers a digitally programmable output from an input voltage supply of 2.5 V to 5.5 V. The output voltage is programmed through an I<sup>2</sup>C interface capable of operating up to 3.4 MHz.

Using a proprietary architecture with synchronous rectification, the FAN53555 is capable of delivering 5 A continuous at over 80% efficiency, while maintaining over 80% efficiency at load currents as low as 10 mA. Pulse currents as high as 6.5 A can be supported by the 05 option. The regulator operates at a nominal fixed frequency of 2.4 MHz, which reduces the value of the external components to 330 nH for the output inductance and as low as 20  $\mu$ F for the output capacitor. Additional output capacitance can be added to improve regulation during load transients without affecting stability. Inductance up to 1.2  $\mu$ H may be used with additional output capacitance.

At moderate and light loads, Pulse Frequency Modulation (PFM) is used to operate in Power-Save Mode with a typical quiescent current of 60  $\mu$ A. Even with such a low quiescent current, the part exhibits excellent transient response during large load swings. At higher loads, the system automatically switches to fixed-frequency control, operating at 2.4 MHz. In Shutdown Mode, the supply current drops below 1  $\mu$ A, reducing power consumption. PFM Mode can be disabled if constant frequency is desired. The FAN53555 is available in a 20-bump, 1.6  $\times$  2 mm, WLCSP.

### Features

- Fixed-Frequency Operation: 2.4 MHz
- Best-in-Class Load Transient
- Continuous Output Current Capability: 5 A

- Pulse Current Capability: 6.5 A (05 Option)
- 2.5 V to 5.5 V Input Voltage Range
- Digitally Programmable Output Voltage:
  - ♦ 00/01/03/05/08/18 Options: 0.6–1.23 V in 10 mV Steps
  - ♦ 04/042/09/ Options: 0.603–1.411 V in 12.826 mV Steps
  - ♦ 23, 79 Option: 0.60–1.3875 V in 12.5 mV Steps
  - ♦ 24 Option: 0.603–1.420 V in 12.967 mV Steps
  - ♦ 13 Option: 0.8–1.43 V in 10 mV Steps
- Programmable Slew Rate for Voltage Transitions
- I<sup>2</sup>C-Compatible Interface Up to 3.4 Mbps
- PFM Mode for High Efficiency in Light Load
- Quiescent Current in PFM Mode: 60  $\mu$ A (Typical)
- Internal Soft-Start
- Input Under-Voltage Lockout (UVLO)
- Thermal Shutdown and Overload Protection
- 20-Bump Wafer-Level Chip Scale Package (WLCSP)

### Applications

- Application, Graphic, and DSP Processors  
Arm®, Krait, OMAP™, NovaThor™, ARMADA
- Hard Disk Drives
- Tablets, Netbooks, Ultra-Mobile PCs
- Smart Phones
- Gaming Devices

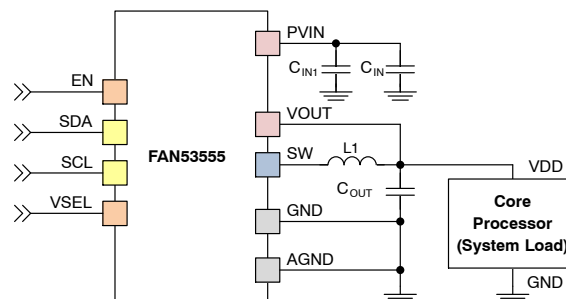


Figure 1. Typical Application

# FAN53555

**Table 1. ORDERING INFORMATION**

Part Number	Power-Up Defaults		I <sup>2</sup> C Slave Address	A1 PIN Function	Max. R <sup>°</sup> C MS Current	Max. Pulse Current (50 ms)	Programmable Output Voltage	EN Pin Low
	VSEL0	VSEL1						
FAN53555UC00X	1.05	1.20	C0	VSEL	5 A	N/A	0.6–1.23 V in 10mV	Registers not reset
FAN53555UC01X	0.90	OFF		VSEL	5 A	N/A		
FAN53555UC03X	0.90	N/A		PGOOD	5 A	N/A		
FAN53555UC04X	1.10	1.20		VSEL	5 A	N/A	0.603–1.411 V in 12.826mV	Registers reset
FAN53555UC05X	0.90	OFF		VSEL	5 A	6.5 A	0.6–1.23 V in 10mV	Registers not reset
FAN53555BUC05X (Note 1)	0.90	OFF		VSEL	5 A	6.5 A		
FAN53555UC08X	1.02	1.15		VSEL	4 A	N/A		
FAN53555BUC08X (Note 1)	1.02	1.15		VSEL	4 A	N/A		
FAN53555BUC09X (Note 1)	1.10	1.10		VSEL	3 A	N/A	0.603–1.411 V in 12.826mV	
FAN53555UC09X	1.10	1.10		VSEL	3 A	N/A		
FAN53555UC13X	1.15	1.15		VSEL	5 A	N/A	0.8–1.43 V in 10mV	
FAN53555BUC13X (Note 1)	1.15	1.15		VSEL	5 A	N/A		
FAN53555UC18X	1.02	1.15		VSEL	5 A	N/A	0.6–1.23 V in 10mV	
FAN53555BUC18X (Note 1)	1.02	1.15		VSEL	5 A	N/A		
FAN53555BUC79X	0.85	N/A		PGOOD	5 A	N/A		
FAN53555BUC23X (Note 1)	1.15	1.15		VSEL	5 A	N/A	0.6–1.3875 V in 12.5mV	Registers not reset
FAN53555UC24X	1.225	1.212	VSEL	4 A	N/A	0.603–1.42 V in 12.967mV	Registers reset	
FAN53555BUC24X (Note 1)	1.225	1.212	VSEL	4 A	N/A			
FAN53555UC042X (Note 2)	1.10	1.20	C4	VSEL	5 A	N/A	0.603–1.411 V in 12.826mV	

1. The FAN53555BUC05X, FAN53555BUC08X, FAN53555BUC09X, FAN53555BUC13X, FAN53555BUC18X, FAN53555BUC23X, and FAN53555BUC24X, include backside lamination.
2. The 042 option is the same as the 04 option, except the I<sup>2</sup>C slave addresses.
3. Temperature Range –40 to 85 °C, Package WLCSP–20, Packing Method Tape & Reel

# FAN53555

## RECOMMENDED EXTERNAL COMPONENTS

**Table 2. RECOMMENDED EXTERNAL COMPONENTS FOR 5 A MAXIMUM LOAD CURRENT**

Component	Description	Vendor	Parameter	Typ.	Unit
L1	330 nH Nominal	See Table 3	L	0.33	μH
			DCR	13	mΩ
C <sub>OUT</sub>	2 Pieces; 22 μF, 6.3 V, X5R, 0805	GRM21BR60J226M (Murata) C2012X5R0J226M (TDK)	C	44	μF
C <sub>IN</sub>	1 Piece; 10 μF, 10 V, X5R, 0805	LMK212BJ106KG-T (Taiyo Yuden) C2012X5R1A106M (TDK)	C	10	
	2 Pieces; 10 μF, 6.3 V, X5R, 0805	GRM21BR60J106M (Murata) C2012X5R0J106M (TDK)	C	20	
C <sub>IN1</sub>	10 nF, 25 V, X7R, 0402	GRM155R71E103K (Murata) C1005X7R1E103K (TDK)	C	10	nF

**Table 3. RECOMMENDED INDUCTORS FOR HIGH-CURRENT APPLICATIONS**

Manufacturer	Part#	L (nH)	DCR (mΩ)	I <sub>MAXDC</sub> (Note 4)	Component Dimensions		
					L	W	H
Vishay	IHLP1616ABERR47M01	470	20.0	5.0	4.5	4.1	1.2
Mag. Layers (Note 5)	MMD-04ABNR33M-M1-RU	330	12.5	7.5	4.5	4.1	1.2
Mag. Layers	MMD-04ABNR47M-M1-RU	470	20.0	5.0	4.5	4.1	1.2
Inter-Technical	SM1608-R33M	330	9.6	9.0	4.5	4.1	2.0
Bournes	SRP4012-R33M	330	15.0	6.7	4.7	4.2	1.2
Bournes	SRP4012-R47M	470	20.0	5.0	4.7	4.2	1.2
TDK	VLC5020T-R47M	470	15.0	5.4	5.0	5.0	2.0

4. I<sub>MAXDC</sub> is the lesser current to produce 40°C temperature rise or 30% inductance roll-off.

5. Preferred inductor value is 330 nH and all dynamic characterization was performed with this coil.

### FAN53555-24, -08, and -09 REDUCED OUTPUT CURRENT (4 A Max. RMS. for 08, and 24, 3 A Max. RMS for 09) SMALLER FOOTPRINT APPLICATION

The FAN53555-24, -08, and -09 were developed to provide power for core processors with high-performance graphics acceleration in Li-Ion-powered handheld devices. These applications require a very compact solution. The smaller input and output capacitors in the table below

assume that additional bypass capacitance exists across the battery in fairly close proximity to the regulator(s). The C<sub>IN</sub> capacitors specified below are the capacitors that are required in very close proximity to VIN and PGND (see layout recommendations in Figure 2 below).

**Table 4. RECOMMENDED EXTERNAL COMPONENTS FOR LOWER-CURRENT APPLICATIONS WITH FAN53555-08-09-24**

Component	Description	Vendor	Parameter	Typ	Unit
L1	470 or 330 nH, 2016 case size	See Table 5			
C <sub>OUT</sub>	-08, -24 Option 2 Pieces 22 μF, 6.3 V, X5R, 0603	C1608X5R0J226M (TDK)	C	44	μF
	-09 Option 1 Piece 22 μF, 6.3 V, X5R, 0603			22	
C <sub>IN</sub>	1 Piece; 10 μF, 10 V, X5R, 0402	GRM155R61A106M (Murata)	C	10	
C <sub>IN1</sub>	10 nF, 25 V, X5R, 0201	TMK063CG100DT-F (Taiyo Yuden)	C	10	nF

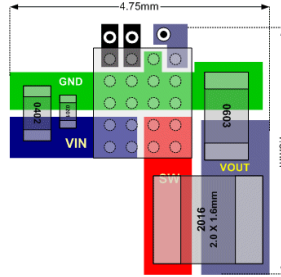
# FAN53555

**Table 5. RECOMMENDED INDUCTORS FOR LOWER-CURRENT APPLICATIONS WITH FAN53555-08-09-24**

Manufacturer	Part#	L (nH)	DCR (mΩ Typ.)	I <sub>MAXDC</sub> (Note 6)	Component Dimensions		
					L	W	H
Toko	DFE201612R-H-R33N	330	25	3.2	2.0	1.6	1.2
Toko	DFE201612C-R47N	470	40	3.2	2.0	1.6	1.2
Cyntek	PIFE20161B-R47MS-39	470	30	3.1	2.0	1.6	1.2
SEMCO	CIGT201610HMR47SCE	470	30	3.1	2.0	1.6	0.9

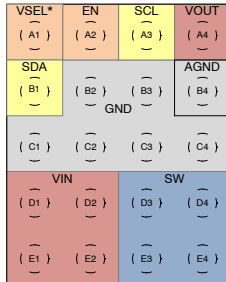
6. I<sub>MAXDC</sub> is the lesser current to produce 40°C temperature rise or 30% inductance roll-off.

## LAYOUT

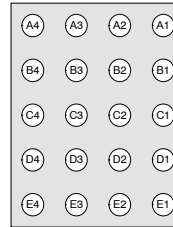


**Figure 2. Reduced-Footprint Layout**

## PIN CONFIGURATION



**Figure 3. Top View**



A1 = VSEL for 00, 01, 04, 05, 08, 09, 13, 18, 23, 24  
A1 = PGOOD for 03,79

**Figure 4. Bottom View**

**Table 6. PIN DEFINITIONS**

Pin #	Name	Description
A1	VSEL (Except -03 Option)	Voltage Select. When this pin is LOW, V <sub>OUT</sub> is set by the VSEL0 register. When this pin is HIGH, V <sub>OUT</sub> is set by the VSEL1 register.
	PGOOD (03)	Power Good. This open-drain pin pulls LOW if an overload condition occurs or soft-start is in progress.
A2	EN	Enable. The device is in Shutdown Mode when this pin is LOW. All register values are kept during shutdown. Options 00, 01, 03, 05, 08, 09, 13, 18, and 23 do not reset register values when EN is raised. The 04, 24, 79, and 042 options reset all registers to default values when EN pin is LOW. If pulled up to a low-impedance voltage source greater than 1.8 V, use at least 100 Ω series resistor.
A3	SCL	I <sup>2</sup> C Serial Clock
A4	VOUT	VOUT. Sense pin for VOUT. Connect to COUT.
B1	SDA	I <sup>2</sup> C Serial Data
B2, B3, C1 - C4	GND	Ground. Low-side MOSFET is referenced to this pin. C <sub>IN</sub> and C <sub>OUT</sub> should be returned with a minimal path to these pins.
B4	AGND	Analog Ground. All signals are referenced to this pin. Avoid routing high dV/dt AC currents through this pin.

**Table 6. PIN DEFINITIONS** (continued)

Pin #	Name	Description
D1, D2, E1, E2	VIN	Power Input Voltage. Connect to the input power source. Connect to C <sub>IN</sub> with minimal path.
D3, D4, E3, E4	SW	Switching Node. Connect to the inductor.

**Table 7. ABSOLUTE MAXIMUM RATINGS**

Symbol	Parameter	Min	Max	Unit	
V <sub>IN</sub>	Voltage on SW, VIN Pins	IC Not Switching	-0.3	7.0	V
		IC Switching	-0.3	6.5	
	Voltage on EN Pin	Tied without Series Resistance	-0.3	2.0	V
		Tied through Series Resistance of at Least 100 Ω	-0.3	V <sub>IN</sub> (Note 7)	
	Voltage on All Other Pins	IC Not Switching	-0.3	V <sub>IN</sub> (Note 7)	V
V <sub>OUT</sub>	Voltage on VOUT Pin	-0.3	3.0	V	
V <sub>INOV_SLEW</sub>	Maximum Slew Rate of V <sub>IN</sub> > 6.5 V, PWM Switching		100	V/ms	
ESD	Electrostatic Discharge Protection Level	Human Body Model per JESD22-A114	2000		V
		Charged Device Model per JESD22-C101	1500		
T <sub>J</sub>	Junction Temperature	-40	+150	°C	
T <sub>STG</sub>	Storage Temperature	-65	+150	°C	
T <sub>L</sub>	Lead Soldering Temperature, 10 Seconds		+260	°C	

Stresses exceeding those listed in the Maximum Ratings table may damage the device. If any of these limits are exceeded, device functionality should not be assumed, damage may occur and reliability may be affected.

7. Lesser of 7 V or V<sub>IN</sub> + 0.3 V.

**Table 8. RECOMMENDED OPERATING CONDITIONS**

The Recommended Operating Conditions table defines the conditions for actual device operation. Recommended operating conditions are specified to ensure optimal performance to the datasheet specifications. ON Semiconductor does not recommend exceeding them or designing to Absolute Maximum Ratings.

Symbol	Parameter	Min	Typ	Max	Unit
V <sub>IN</sub>	Supply Voltage Range	2.5		5.5	V
I <sub>OUT</sub>	Output Current	0		5	A
L	Inductor		0.33		μH
C <sub>IN</sub>	Input Capacitor		10		μF
C <sub>OUT</sub>	Output Capacitor		44		μF
T <sub>A</sub>	Operating Ambient Temperature	-40		+85	°C
T <sub>J</sub>	Operating Junction Temperature	-40		+125	°C

**Table 9. THERMAL PROPERTIES**

Symbol	Parameter	Min	Typ	Max	Unit
θ <sub>JA</sub>	Junction-to-Ambient Thermal Resistance (Note 8)		38		°C/W

8. See Thermal Considerations in the Application Information section.

**Table 10. ELECTRICAL CHARACTERISTICS**

Minimum and maximum values are at  $V_{IN} = 2.5\text{ V to }5.5\text{ V}$ ,  $T_A = -40^\circ\text{C to }+85^\circ\text{C}$ , unless otherwise noted. Typical values are at  $T_A = 25^\circ\text{C}$ ,  $V_{IN} = 5\text{ V}$ , and  $EN = \text{HIGH}$ .

Symbol	Parameter	Condition	Min	Typ	Max	Unit
<b>POWER SUPPLIES</b>						
$I_Q$	Quiescent Current	$I_{LOAD} = 0$		60	100	$\mu\text{A}$
		$I_{LOAD} = 0$ , MODE Bit = 1 (Forced PWM)		43		$\text{mA}$
$I_{SD}$	H/W Shutdown Supply Current	$EN = \text{GND}$		0.1	5.0	$\mu\text{A}$
	S/W Shutdown Supply Current	$EN = V_{IN}$ , BUCK_ENx = 0		41	75	$\mu\text{A}$
$V_{UVLO}$	Under-Voltage Lockout Threshold	$V_{IN}$ Rising		2.35	2.45	V
$V_{UVHYST}$	Under-Voltage Lockout Hysteresis			350		$\text{mV}$

**EN, VSEL, SDA, SCL**

$V_{IH}$	High-Level Input Voltage		1.1			V
$V_{IL}$	Low-Level Input Voltage				0.4	V
$V_{LHYST}$	Logic Input Hysteresis Voltage			160		$\text{mV}$
$I_{IN}$	Input Bias Current	Input Tied to GND or $V_{IN}$		0.01	1.00	$\mu\text{A}$

**PGOOD (03, 79 OPTION)**

$I_{OUTL}$	PGOOD Pull-Down Current				1	$\text{mA}$
$I_{OUTH}$	PGOOD HIGH Leakage Current			0.01	1.00	$\mu\text{A}$

**$V_{OUT}$  REGULATION**

$V_{REG}$	$V_{OUT}$ DC Accuracy	$I_{OUT(DC)} = 0$ , Forced PWM, $V_{OUT} = \text{VSEL0}$ Default Value	-1.5		1.5	%	
		08, 24 Options	$2.5\text{ V} \leq V_{IN} \leq 4.5\text{ V}$ , $V_{OUT}$ from Minimum to Maximum, $I_{OUT(DC)} = 0$ to 4 A, Auto PFM/PWM	-2.0		4.0	%
		09 Option	$2.5\text{ V} \leq V_{IN} \leq 4.5\text{ V}$ , $V_{OUT}$ from Minimum to Maximum, $I_{OUT(DC)} = 0$ to 3 A, Auto PFM/PWM	-2.0		4.0	%
		13, 18, 23 Options	$2.5\text{ V} \leq V_{IN} \leq 4.5\text{ V}$ , $V_{OUT}$ from Minimum to Maximum, $I_{OUT(DC)} = 0$ to 5 A, Auto PFM/PWM	-2.0		4.0	%
		All Other Options	$2.5\text{ V} \leq V_{IN} \leq 5.5\text{ V}$ , $V_{OUT}$ from Minimum to Maximum, $I_{OUT(DC)} = 0$ to 5 A, Auto PFM/PWM	-3.0		5.0	%
$\frac{\Delta V_{OUT}}{\Delta I_{LOAD}}$	Load Regulation	$I_{OUT(DC)} = 1$ to 5 A		-0.1		%/A	
$\frac{\Delta V_{OUT}}{\Delta V_{IN}}$	Line Regulation	$2.5\text{ V} \leq V_{IN} \leq 5.5\text{ V}$ , $I_{OUT(DC)} = 1.5\text{ A}$		0.01		%/V	
$V_{TRSP}$	Transient Response	$I_{LOAD}$ Step 0.1 A to 1.5 A, $t_r = t_f = 100\text{ ns}$ , $V_{OUT} = 1.2\text{ V}$		$\pm 40$		$\text{mV}$	

**POWER SWITCH AND PROTECTION**

$R_{DS(on)P}$	P-Channel MOSFET On Resistance	$V_{IN} = 5\text{ V}$		28		$\text{m}\Omega$
$R_{DS(on)N}$	N-Channel MOSFET On Resistance	$V_{IN} = 5\text{ V}$		17		$\text{m}\Omega$

# FAN53555

**Table 10. ELECTRICAL CHARACTERISTICS** (continued)

Minimum and maximum values are at  $V_{IN} = 2.5\text{ V to }5.5\text{ V}$ ,  $T_A = -40^\circ\text{C to }+85^\circ\text{C}$ , unless otherwise noted. Typical values are at  $T_A = 25^\circ\text{C}$ ,  $V_{IN} = 5\text{ V}$ , and  $EN = \text{HIGH}$ .

Symbol	Parameter	Condition	Min	Typ	Max	Unit
<b>POWER SWITCH AND PROTECTION</b>						
$I_{LIMPK}$	P-MOS Peak Current Limit	00, 01, 03, 04, 13, 18, 23, 042, 79 Options	6.3	7.4	8.5	A
		05 Option	8.5	10.0	11.5	A
		08, 24 Options	5.0	5.9	6.8	A
		09 Option	4.0	4.75	5.5	
$T_{LIMIT}$	Thermal Shutdown		150			$^\circ\text{C}$
$T_{HYST}$	Thermal Shutdown Hysteresis		17			$^\circ\text{C}$
$V_{SDWN}$	Input OVP Shutdown	Rising Threshold		6.15		V
		Falling Threshold	5.50	5.85		V

## FREQUENCY CONTROL

Symbol	Parameter	Condition	Min	Typ	Max	Unit
$f_{SW}$	Oscillator Frequency		2.05	2.40	2.75	MHz

## DAC

Symbol	Parameter	Condition	Min	Typ	Max	Unit
	Resolution			6		Bits
	Differential Nonlinearity (Note 9)				0.5	LSB

## TIMING

Symbol	Parameter	Condition	Min	Typ	Max	Unit
$t_{CEN}$	EN = HIGH to I <sup>2</sup> C Start		100			$\mu\text{s}$

## SOFT-START

Symbol	Parameter	Condition	Min	Typ	Max	Unit
$t_{SS}$	Regulator Enable to Regulated $V_{OUT}$	$R_{LOAD} > 5\ \Omega$ ; to $V_{OUT} = 1.2\text{ V}$ ; 00, 01, 03, 04, 042, 05, 09, 13, 23 and 79 Options		300		$\mu\text{s}$
		$2.5\text{ V} \leq V_{IN} \leq 4.5\text{ V}$ ; $R_{LOAD} = 2\ \Omega$ ; to $V_{OUT} = 1.127\text{ V}$ with 1.1 V Pre-Bias Voltage; 08 and 18 Options		135	175	$\mu\text{s}$
$R_{OFF}$	$V_{OUT}$ Pull-Down Resistance, Disabled	$EN = 0$ or $V_{IN} < V_{UVLO}$		160		$\Omega$

Product parametric performance is indicated in the Electrical Characteristics for the listed test conditions, unless otherwise noted. Product performance may not be indicated by the Electrical Characteristics if operated under different conditions.  
9. Monotonicity assured by design.

**Table 11. I<sup>2</sup>C TIMING SPECIFICATIONS**

Guaranteed by design.

Symbol	Parameter	Condition	Min.	Typ.	Max.	Unit
$f_{SCL}$	SCL Clock Frequency	Standard Mode			100	kHz
		Fast Mode			400	
		Fast Mode Plus			1000	
		High-Speed Mode, $C_B \leq 100\text{ pF}$			3400	
		High-Speed Mode, $C_B \leq 400\text{ pF}$			1700	
$t_{BUF}$	Bus-Free Time between STOP and START Conditions	Standard Mode		4.7		$\mu\text{s}$
		Fast Mode		1.3		
		Fast Mode Plus		0.5		
$t_{HD;STA}$	START or REPEATED START Hold Time	Standard Mode		4		$\mu\text{s}$
		Fast Mode		600		ns
		Fast Mode Plus		260		ns
		High-Speed Mode		160		ns

# FAN53555

**Table 11. I<sup>2</sup>C TIMING SPECIFICATIONS** (continued)

Guaranteed by design.

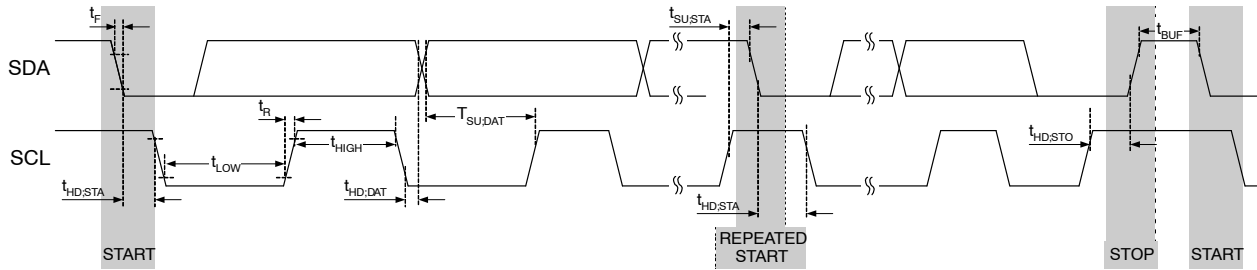
Symbol	Parameter	Condition	Min.	Typ.	Max.	Unit
t <sub>LOW</sub>	SCL LOW Period	Standard Mode		4.7		μs
		Fast Mode		1.3		μs
		Fast Mode Plus		0.5		μs
		High-Speed Mode, C <sub>B</sub> ≤ 100 pF		160.0		ns
		High-Speed Mode, C <sub>B</sub> ≤ 400 pF		320.0		ns
t <sub>HIGH</sub>	SCL HIGH Period	Standard Mode		4		μs
		Fast Mode		600		ns
		Fast Mode Plus		260		ns
		High-Speed Mode, C <sub>B</sub> ≤ 100 pF		60		ns
		High-Speed Mode, C <sub>B</sub> ≤ 400 pF		120		ns
t <sub>SU;STA</sub>	Repeated START Setup Time	Standard Mode		4.7		μs
		Fast Mode		600.0		ns
		Fast Mode Plus		260.0		ns
		High-Speed Mode		160.0		ns
t <sub>SU;DAT</sub>	Data Setup Time	Standard Mode		250		ns
		Fast Mode		100		
		Fast Mode Plus		50		
		High-Speed Mode		10		
t <sub>HD;DAT</sub>	Data Hold Time	Standard Mode	0		3.45	μs
		Fast Mode	0		900.00	ns
		Fast Mode Plus	0		450.00	ns
		High-Speed Mode, C <sub>B</sub> ≤ 100 pF	0		70.00	ns
		High-Speed Mode, C <sub>B</sub> ≤ 400 pF	0		150.00	ns
t <sub>RCL</sub>	SCL Rise Time	Standard Mode		20+0.1C <sub>B</sub>	1000	ns
		Fast Mode		20+0.1C <sub>B</sub>	300	
		Fast Mode Plus		20+0.1C <sub>B</sub>	120	
		High-Speed Mode, C <sub>B</sub> ≤ 100 pF		10	80	
		High-Speed Mode, C <sub>B</sub> ≤ 400 pF		20	160	
t <sub>FCL</sub>	SCL Fall Time	Standard Mode		20+0.1C <sub>B</sub>	300	ns
		Fast Mode		20+0.1C <sub>B</sub>	300	
		Fast Mode Plus		20+0.1C <sub>B</sub>	120	
		High-Speed Mode, C <sub>B</sub> ≤ 100 pF		10	40	
		High-Speed Mode, C <sub>B</sub> ≤ 400 pF		20	80	
t <sub>RCL1</sub>	Rise Time of SCL After a REPEATED START Condition and After ACK Bit	High-Speed Mode, C <sub>B</sub> ≤ 100 pF		10	80	ns
		High-Speed Mode, C <sub>B</sub> ≤ 400 pF		20	160	
t <sub>RDA</sub>	SDA Rise Time	Standard Mode		20+0.1C <sub>B</sub>	1000	ns
		Fast Mode		20+0.1C <sub>B</sub>	300	
		Fast Mode Plus		20+0.1C <sub>B</sub>	120	
		High-Speed Mode, C <sub>B</sub> ≤ 100 pF		10	80	
		High-Speed Mode, C <sub>B</sub> ≤ 400 pF		20	160	

**Table 11. I<sup>2</sup>C TIMING SPECIFICATIONS** (continued)

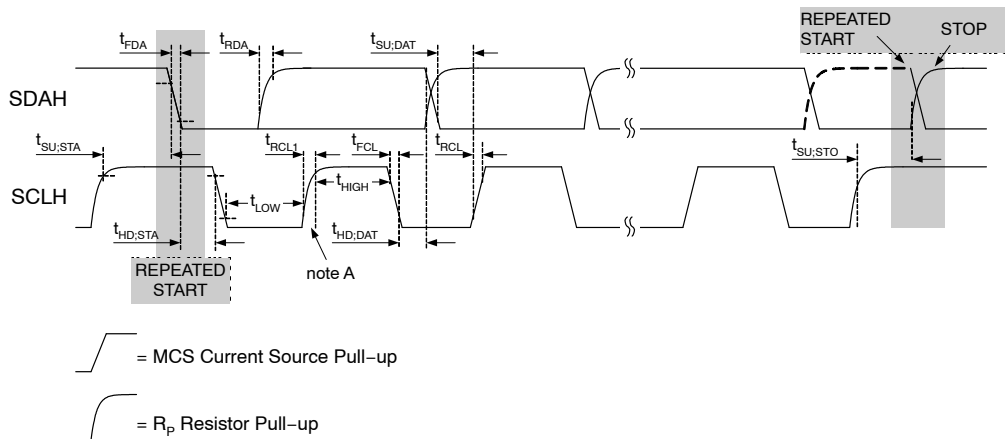
Guaranteed by design.

Symbol	Parameter	Condition	Min.	Typ.	Max.	Unit
t <sub>FDA</sub>	SDA Fall Time	Standard Mode		20+0.1C <sub>B</sub>	300	ns
		Fast Mode		20+0.1C <sub>B</sub>	300	
		Fast Mode Plus		20+0.1C <sub>B</sub>	120	
		High-Speed Mode, C <sub>B</sub> ≤ 100 pF		10	80	
		High-Speed Mode, C <sub>B</sub> ≤ 400 pF		20	160	
t <sub>SU;STO</sub>	Stop Condition Setup Time	Standard Mode		4		μs
		Fast Mode		600		ns
		Fast Mode Plus		120		ns
		High-Speed Mode		160		ns
C <sub>B</sub>	Capacitive Load for SDA and SCL				400	pF

**TIMING DIAGRAMS**



**Figure 5. I<sup>2</sup>C Interface Timing for Fast Plus, Fast, and Slow Modes**



= MCS Current Source Pull-up  
 = R<sub>p</sub> Resistor Pull-up

Note A: First rising edge of SCLH after Repeated Start and after each ACK bit.

**Figure 6. I<sup>2</sup>C Interface Timing for High-Speed Mode**

TYPICAL CHARACTERISTICS

Unless otherwise specified, Auto PFM/PWM,  $V_{IN} = 3.6\text{ V}$ ,  $V_{OUT} = 1.2\text{ V}$ ,  $SCL = SDA = VSEL = EN = 1.8\text{ V}$ ,  $T_A = 25^\circ\text{C}$ ; circuit and components according to Figure 1 and Table 1.

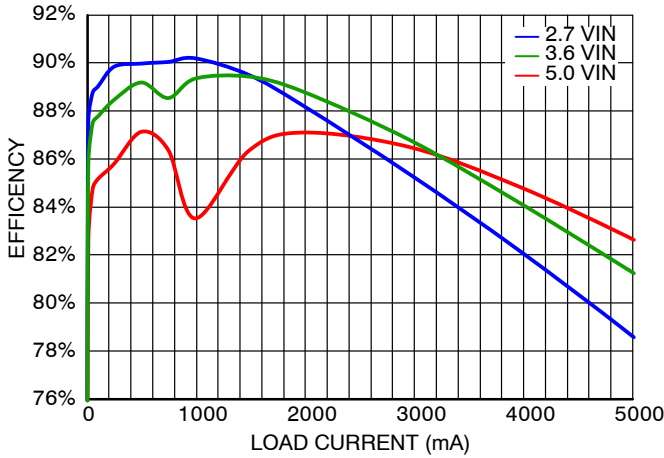


Figure 7. Efficiency vs. Load Current and Input Voltage

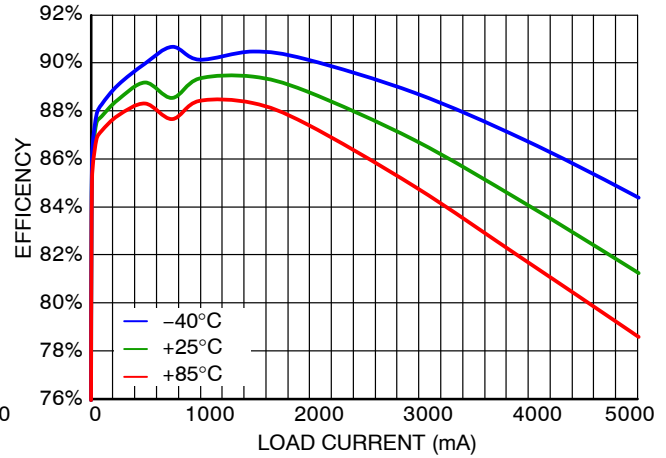


Figure 8. Efficiency vs. Load Current and Temperature

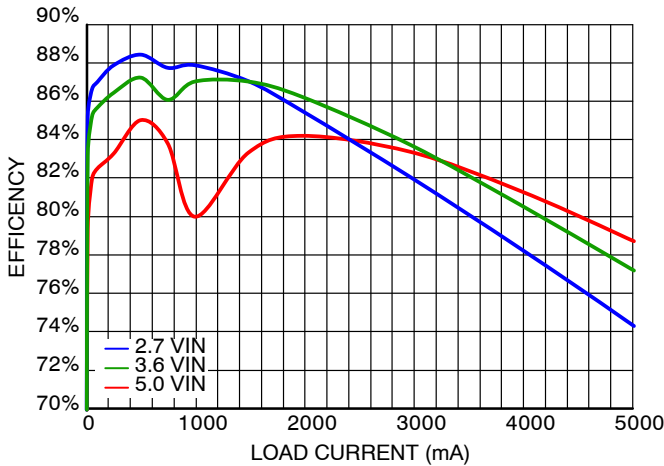


Figure 9. Efficiency vs. Load Current and Input Voltage,  $V_{OUT} = 0.9\text{ V}$

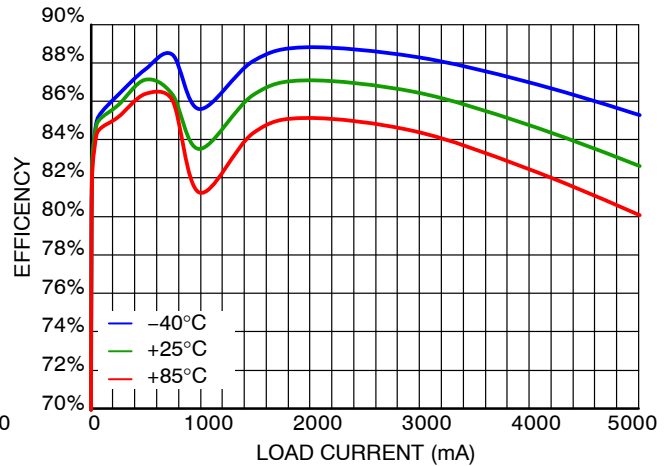


Figure 10. Efficiency vs. Load Current and Temperature,  $V_{IN} = 5\text{ V}$ ,  $V_{OUT} = 1.2\text{ V}$

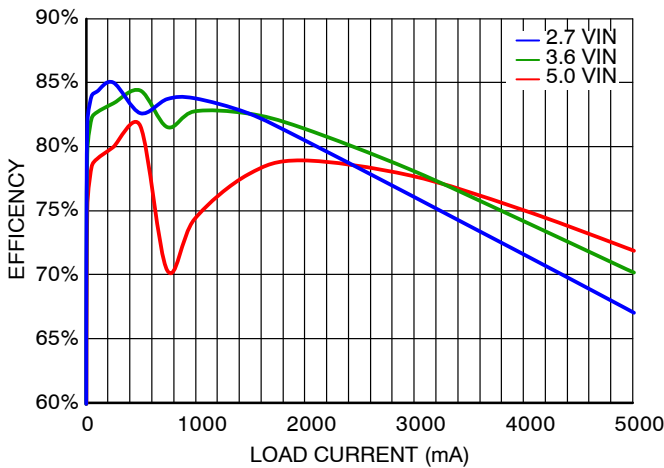


Figure 11. Efficiency vs. Load Current and Input Voltage,  $V_{OUT} = 0.6\text{ V}$

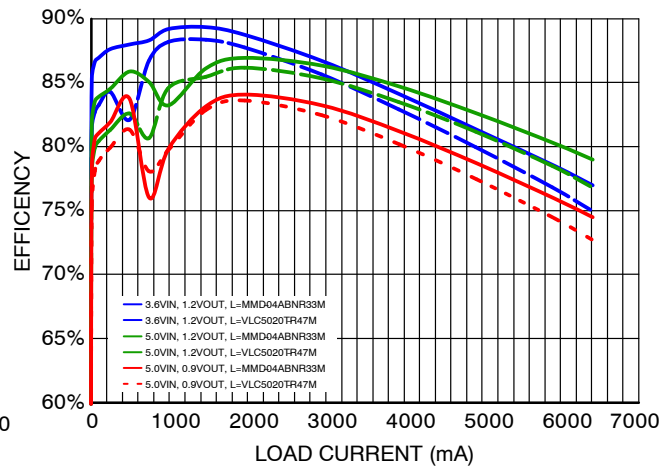
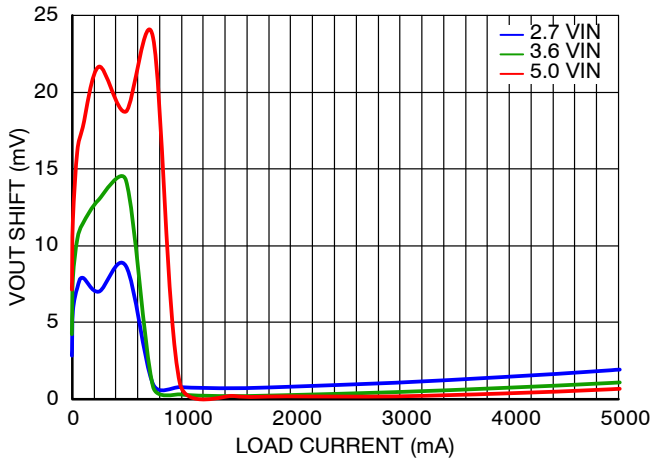


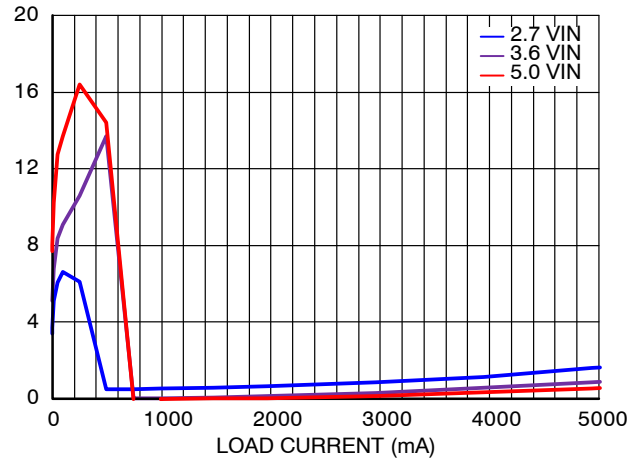
Figure 12. Efficiency vs. Load Current,  $V_{IN} = 3.6\text{ V}$  and  $5\text{ V}$ ,  $V_{OUT} = 1.2\text{ V}$  and  $0.9\text{ V}$

**TYPICAL CHARACTERISTICS** (continued)

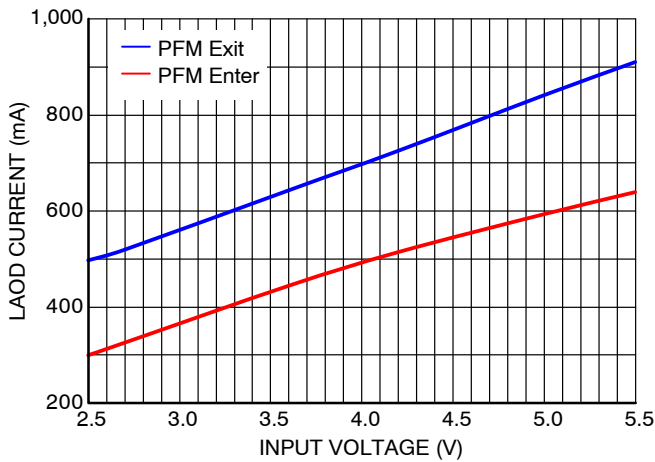
Unless otherwise specified, Auto PFM/PWM,  $V_{IN} = 3.6\text{ V}$ ,  $V_{OUT} = 1.2\text{ V}$ ,  $SCL = SDA = VSEL = EN = 1.8\text{ V}$ ,  $T_A = 25^\circ\text{C}$ ; circuit and components according to Figure 1 and Table 1.



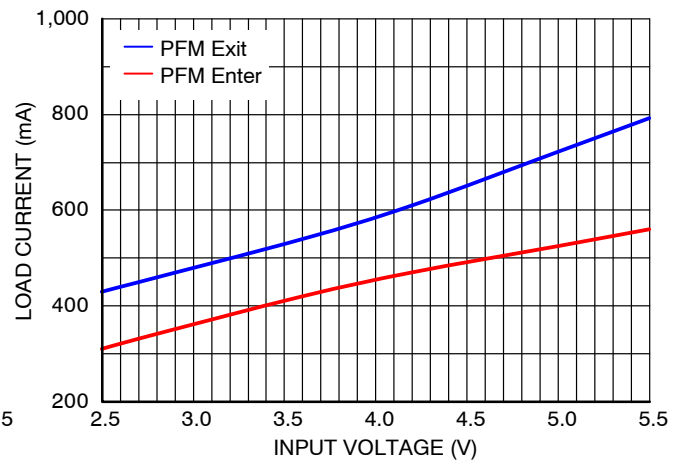
**Figure 13. Output Regulation vs. Load Current and Input Voltage,  $V_{OUT} = 1.2\text{ V}$**



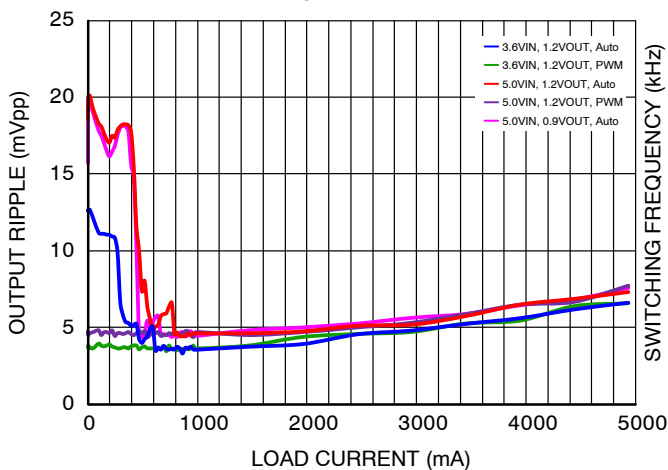
**Figure 14. Output Regulation vs. Load Current and Input Voltage,  $V_{OUT} = 0.9\text{ V}$**



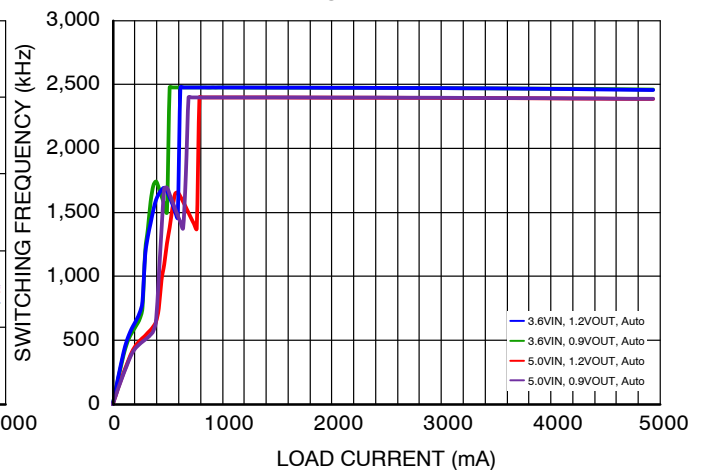
**Figure 15. PFM Entry / Exit Level vs. Input Voltage,  $V_{OUT} = 1.2\text{ V}$**



**Figure 16. PFM Entry / Exit Level vs. Input Voltage,  $V_{OUT} = 0.9\text{ V}$**



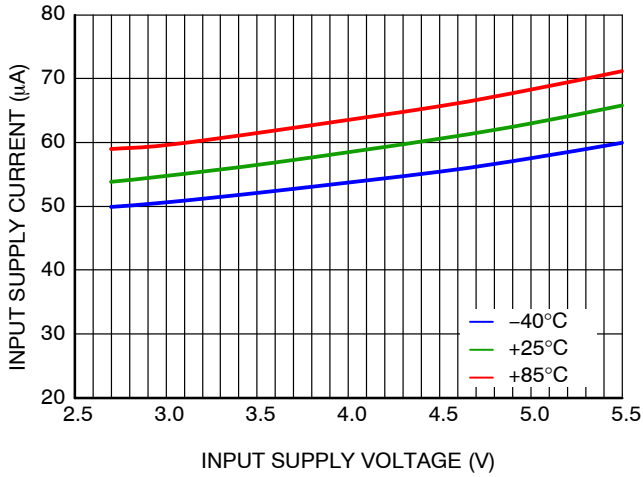
**Figure 17. Output Ripple vs. Load Current,  $V_{IN} = 5\text{ V}$  and  $3.6\text{ V}$ ,  $V_{OUT} = 1.2\text{ V}$  and  $0.9\text{ V}$ , Auto and FPWM**



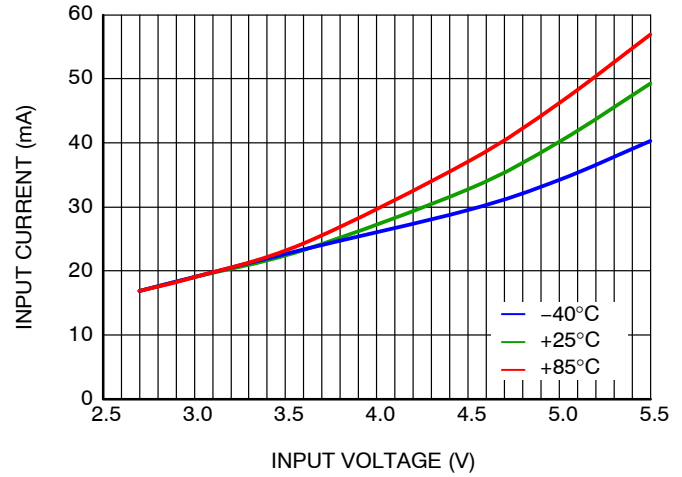
**Figure 18. Frequency vs. Load Current,  $V_{IN} = 5\text{ V}$  and  $3.6\text{ V}$ ,  $V_{OUT} = 1.2\text{ V}$  and  $0.9\text{ V}$ , Auto PWM**

**TYPICAL CHARACTERISTICS** (Continued)

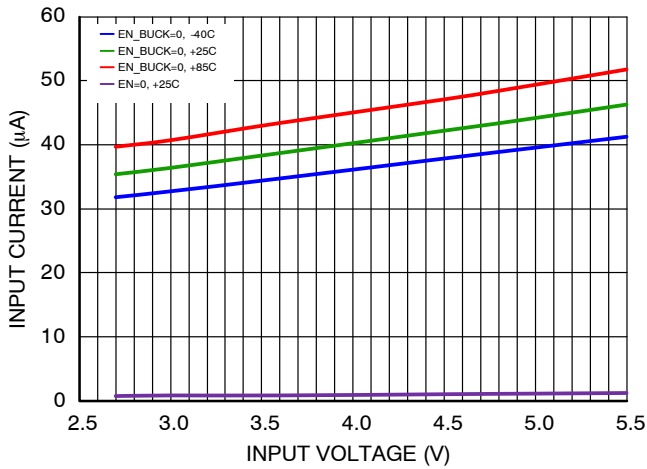
Unless otherwise specified, Auto PFM/PWM,  $V_{IN} = 3.6\text{ V}$ ,  $V_{OUT} = 1.2\text{ V}$ ,  $SCL = SDA = VSEL = EN = 1.8\text{ V}$ ,  $T_A = 25^\circ\text{C}$ ; circuit and components according to Figure 1 and Table 1.



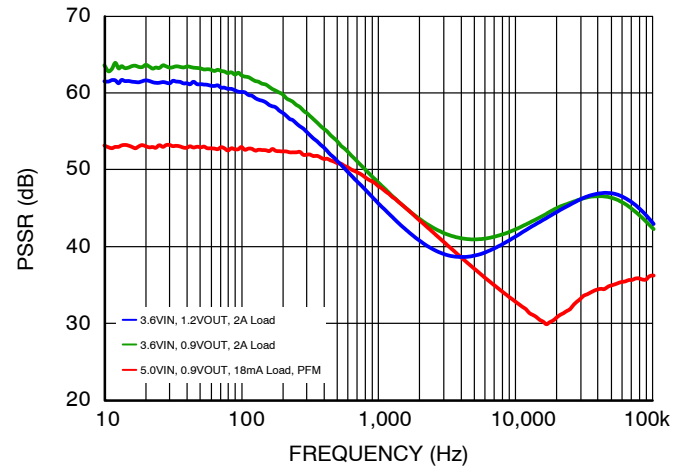
**Figure 19. Quiescent Current vs. Input Voltage and Temperature, Auto PWM**



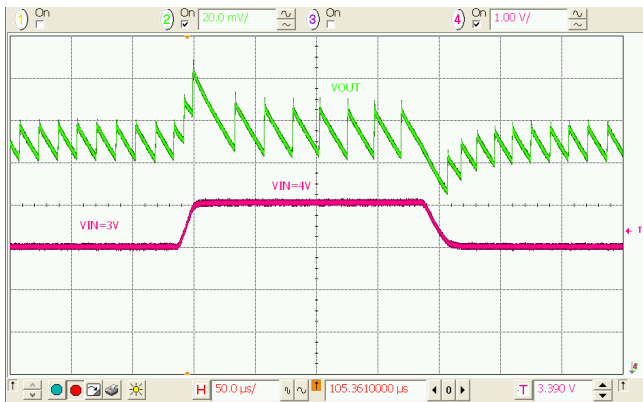
**Figure 20. Quiescent Current vs. Input Voltage and Temperature, FPWM**



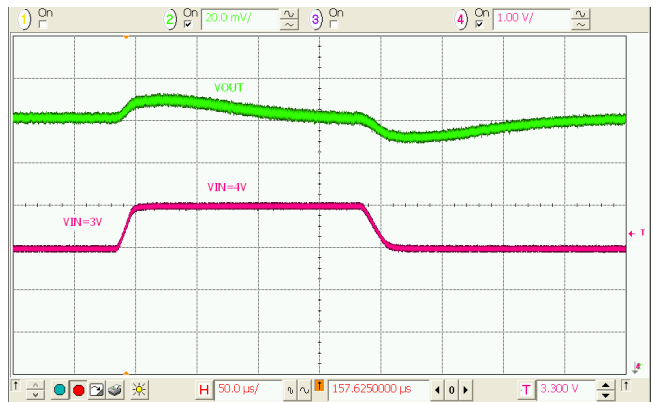
**Figure 21. Shutdown Current vs. Input Voltage and Temperature**



**Figure 22. PSRR vs. Frequency**



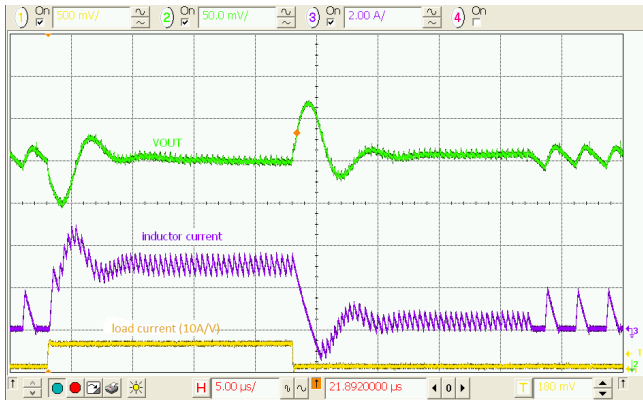
**Figure 23. Line Transient, 3–4  $V_{IN}$ , 1.2  $V_{OUT}$ , 10  $\mu\text{s}$  Edge, 50  $\Omega$  Load**



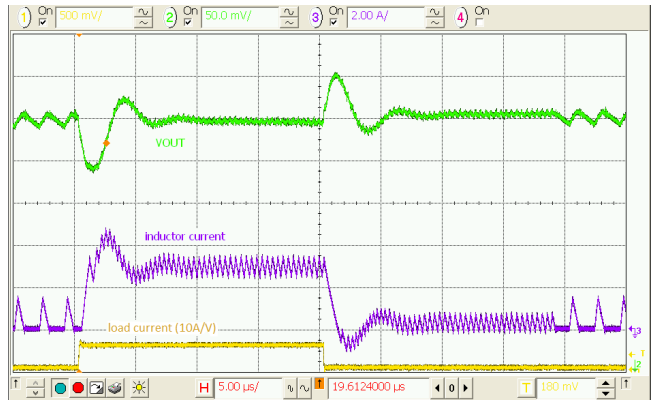
**Figure 24. Line Transient, 3–4  $V_{IN}$ , 1.2  $V_{OUT}$ , 10  $\mu\text{s}$  Edge, 1 A Load**

**TYPICAL CHARACTERISTICS** (Continued)

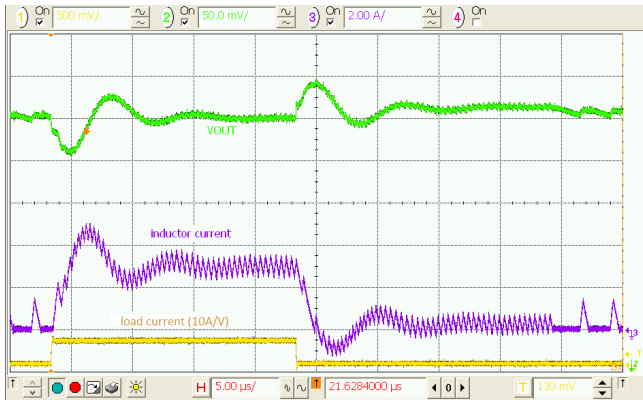
Unless otherwise specified, Auto PFM/PWM,  $V_{IN} = 3.6\text{ V}$ ,  $V_{OUT} = 1.2\text{ V}$ ,  $SCL = SDA = VSEL = EN = 1.8\text{ V}$ ,  $T_A = 25^\circ\text{C}$ ; circuit and components according to Figure 1 and Table 1.



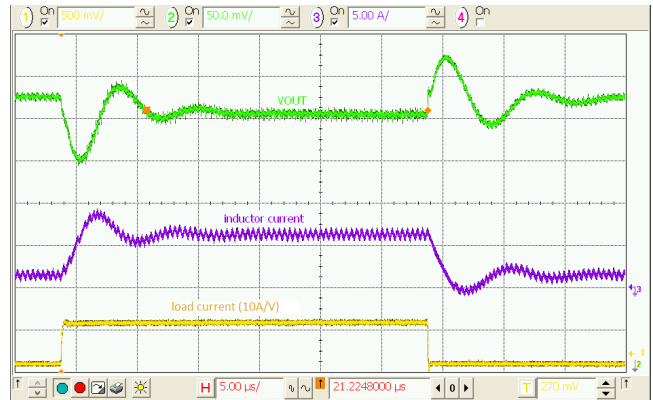
**Figure 25. Load Transient, 5  $V_{IN}$ , 0.9  $V_{OUT}$ , 0.3–3 A, 100 ns Edge**



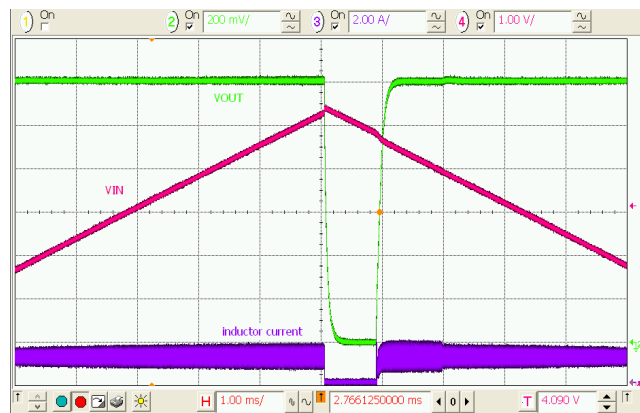
**Figure 26. Load Transient, 3.6  $V_{IN}$ , 1.2  $V_{OUT}$ , 0.3–3 A, 100 ns Edge**



**Figure 27. Load Transient, 3.6  $V_{IN}$ , 1.2  $V_{OUT}$ , 0.3–3 A, 100 ns Edge,  $C_{OUT} = 4 \times 22\ \mu\text{F}$**



**Figure 28. Load Transient, 3.6  $V_{IN}$ , 1.2  $V_{OUT}$ , 1.5–6 A, 100 ns Edge,  $C_{OUT} = 4 \times 22\ \mu\text{F}$**



**Figure 29. Input Over-Voltage Protection**

# FAN53555

## TYPICAL CHARACTERISTICS (Continued)

Unless otherwise specified, Auto PFM/PWM,  $V_{IN} = 3.6\text{ V}$ ,  $V_{OUT} = 1.2\text{ V}$ ,  $SCL = SDA = VSEL = EN = 1.8\text{ V}$ ,  $T_A = 25^\circ\text{C}$ ; circuit and components according to Figure 1 and Table 1.

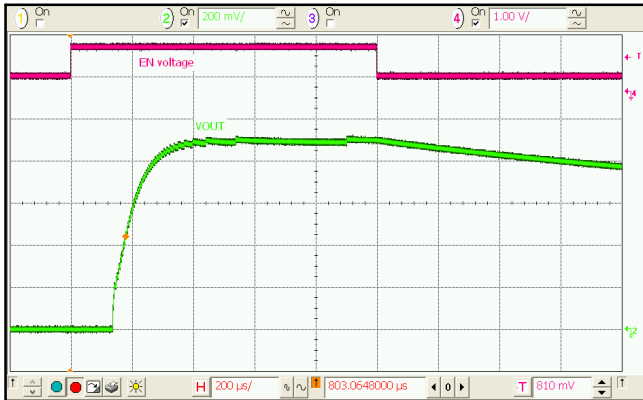


Figure 30. Startup / Shutdown, No Load,  $V_{OUT} = 0.9\text{ V}$

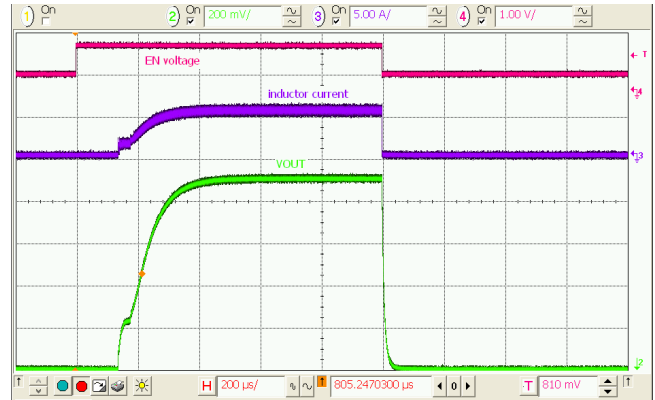


Figure 31. Startup / Shutdown, 180 mΩ Load,  $V_{OUT} = 0.9\text{ V}$

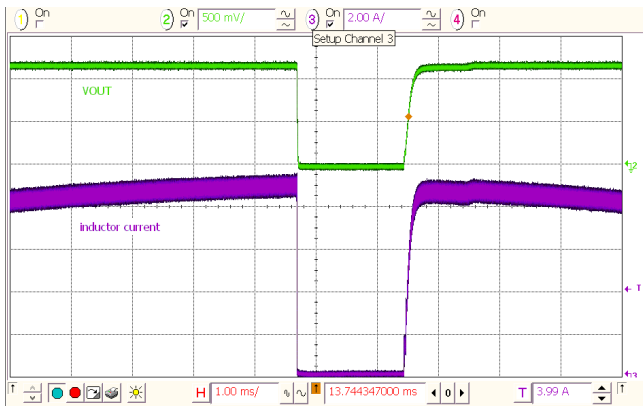


Figure 32. Overload Protection and Recovery

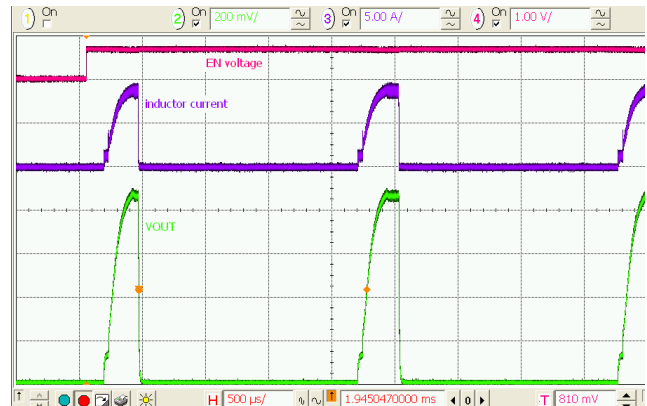


Figure 33. Startup into Faulted Load,  $V_{OUT} = 0.9\text{ V}$

## OPERATION DESCRIPTION

The FAN53555 is a step-down switching voltage regulator that delivers a programmable output voltage from an input voltage supply of 2.5 V to 5.5 V. Using a proprietary architecture with synchronous rectification, the FAN53555 is capable of delivering 5 A at over 80% efficiency. Pulse currents as high as 6.5 A can be supported by the 05 option. The regulator operates at a nominal frequency of 2.4 MHz at full load, which reduces the value of the external components to 330 nH for the output inductor and 22  $\mu\text{F}$  for the output capacitor. High efficiency is maintained at light load with single-pulse PFM.

The FAN53555 integrates an I<sup>2</sup>C-compatible interface, allowing transfers up to 3.4 Mbps. This communication interface can be used to:

- Dynamically re-program the output voltage in 10 mV, 12.826 mV increments (option 04, 09, and 042), 12.5 mV increments (option 23), or 12.967 mV increments (option 24);

- Reprogram the mode to enable or disable PFM;
- Control voltage transition slew rate; or
- Enable / disable the regulator.

### Control Scheme

The FAN53555 uses a proprietary non-linear, fixed-frequency PWM modulator to deliver a fast load transient response, while maintaining a constant switching frequency over a wide range of operating conditions. The regulator performance is independent of the output capacitor ESR, allowing for the use of ceramic output capacitors. Although this type of operation normally results in a switching frequency that varies with input voltage and load current, an internal frequency loop holds the switching frequency constant over a large range of input voltages and load currents.

For very light loads, the FAN53555 operates in Discontinuous Current Diode (DCM) single-pulse PFM,

which produces low output ripple compared with other PFM architectures. Transition between PWM and PFM is relatively seamless, providing a smooth transition between DCM and CCM Modes.

PFM can be disabled by programming the MODE bit HIGH in the VSEL registers.

**Enable and Soft-Start**

When the EN pin is LOW; the IC is shut down, all internal circuits are off, and the part draws very little current. In this state, I<sup>2</sup>C cannot be written to or read from. For all options except the 04, 24, and 042 options, all register values are kept while EN pin is LOW. For the 04, 24 042 and 79 options; registers are reset to default values when EN pin is LOW. For all options, registers are reset to default values during a Power On Reset (POR).

When the OUTPUT\_DISCHARGE bit in the CONTROL register is enabled (logic HIGH) and the EN pin is LOW or the BUCK\_ENx bit is LOW, a load is connected from VOUT to GND to discharge the output capacitors.

Raising EN while the BUCK\_ENx bit is HIGH activates the part and begins the soft-start cycle. During soft-start, the modulator’s internal reference is ramped slowly to minimize surge currents on the input and prevent overshoot of the output voltage. Synchronous rectification is inhibited during soft-start, allowing the IC to start into a pre-charged capacitive load.

If large output capacitance values are used, the regulator may fail to start. Maximum C<sub>OUT</sub> capacitance for successfully starting with a heavy constant-current load is approximately:

$$C_{OUTMAX} = (I_{LIMPK} - I_{LOAD}) \cdot \frac{320\mu}{V_{OUT}} \quad (\text{eq. 1})$$

where C<sub>OUTMAX</sub> is expressed in μF and I<sub>LOAD</sub> is the load current during soft-start, expressed in A.

If the regulator is at its current limit for 16 consecutive current limit cycles, the regulator shuts down and enters 3-state before reattempting soft-start 1700 ms later. This limits the duty cycle of full output current during soft-start to prevent excessive heating.

The IC allows for software enable of the regulator, when EN is HIGH, through the BUCK\_EN bits. BUCK\_EN0 and BUCK\_EN1 are both initialized HIGH in the 00, 04, 08, 09, 23, 24, 42 and 79 options. These options start after a POR regardless of the state of the VSEL pin.

In the 01 and 05 options, BUCK\_EN0 and BUCK\_EN1 are initialized to 10. Using these options, VSEL must be LOW after a POR if the IC is powering the processor used to communicate through I<sup>2</sup>C. The 03 option has the VSEL input to the modulator logic internally tied LOW.

**Table 12. HARDWARE AND SOFTWARE ENABLE**

Pins		BITS		Output
EN	VSEL	BUCK_EN0	BUCK_EN1	
0	X	X	X	OFF
1	0	0	X	OFF
1	0	1	X	ON
1	1	X	0	OFF
1	1	X	1	ON

**VSEL Pin and I<sup>2</sup>C Programming Output Voltage**

The output voltage is set by the NSELx control bits in VSEL0 and VSEL1 registers. The output voltage for options 00, 01, 03, 05, 08, 18 and 79 is given as:

$$V_{OUT} = 0.60 \text{ V} + \text{NSELx} \cdot 10 \text{ mV} \quad (\text{eq. 2})$$

For example, when NSEL = 011111 (31 decimal), then V<sub>OUT</sub> = 0.60 + 0.310 = 0.91 V.

For the 04, 042, and 09 options; the output voltage is given as:

$$V_{OUT} = 0.603 + \text{NSELx} \cdot 12.826 \text{ mV} \quad (\text{eq. 3})$$

For the 13 option, the output voltage is given as:

$$V_{OUT} = 0.80 + \text{NSELx} \cdot 10 \text{ mV} \quad (\text{eq. 4})$$

For the 23 option, the output voltage is given as:

$$V_{OUT} = 0.60 \text{ V} + \text{NSELx} \cdot 12.5 \text{ mV} \quad (\text{eq. 5})$$

For the 24 option, the output voltage is given as:

$$V_{OUT} = 0.603 \text{ V} + \text{NSELx} \times 12.967 \text{ mV} \quad (\text{eq. 6})$$

Output voltage can also be controlled by toggling the VSEL pin LOW or HIGH. VSEL LOW corresponds to VSEL0 and VSEL HIGH corresponds to VSEL1. Upon POR, VSEL0 and VSEL1 are reset to their default voltages, shown in Table 9.

**Transition Slew Rate Limiting**

When transitioning from a low to high voltage, the IC can be programmed for one of eight possible slew rates using the SLEW bits in the CONTROL register.

**Table 13. TRANSITION SLEW RATE**

Decimal	Bin	Slew Rate	
0	000	64.00	mV / $\mu$ s
1	001	32.00	mV / $\mu$ s
2	010	16.00	mV / $\mu$ s
3	011	8.00	mV / $\mu$ s
4	100	4.00	mV / $\mu$ s
5	101	2.00	mV / $\mu$ s
6	110	1.00	mV / $\mu$ s
7	111	0.50	mV / $\mu$ s

Transitions from high to low voltage rely on the output load to discharge  $V_{OUT}$  to the new set point. Once the high-to-low transition begins, the IC stops switching until  $V_{OUT}$  has reached the new set point.

For options 04, 042, 09, 23, and 24 where the Dynamic Voltage Scaling (DVS) step is not 10 mV; the actual slew rate is the corresponding number shown in Table 6 scaled by the ratio of the DVS step to 10 mV. For example, the slew rate of option 13 for Bin=011 is  $8.00 \text{ mV} / \mu\text{s} \times 12.5 \text{ mV} / 10 \text{ mV} = 10.00 \text{ mV} / \mu\text{s}$ .

**Under-Voltage Lockout**

When EN is HIGH, the under-voltage lockout keeps the part from operating until the input supply voltage rises HIGH enough to properly operate. This ensures proper operation of the regulator during startup or shutdown.

**Input Over-Voltage Protection (OVP)**

When  $V_{IN}$  exceeds  $V_{SDWN}$  (about 6.2 V) the IC stops switching to protect the circuitry from internal spikes above 6.5 V. An internal filter prevents the circuit from shutting down due to noise spikes.

**Power Good (03 & 79 Option)**

The PGOOD pin is an open-drain output indicating that the regulator is enabled when its state is HIGH. PGOOD pulls LOW under the following conditions:

- Regulator is disabled (EN pin LOW, disabled by I<sup>2</sup>C, fault time-out, UVLO, OVP, over-temperature);
- Regulator is performing a soft-start.

PGOOD remains HIGH during I<sup>2</sup>C initiated  $V_{OUT}$  transitions.

**Current Limiting**

A heavy load or short circuit on the output causes the current in the inductor to increase until a maximum current threshold is reached in the high-side switch. Upon reaching this point, the high-side switch turns off, preventing high

currents from causing damage. Sixteen consecutive current limit cycles in current limit cause the regulator to shut down and stay off for about 1700  $\mu$ s before attempting a restart.

**Thermal Shutdown**

When the die temperature increases, due to a high load condition and/or high ambient temperature, the output switching is disabled until the die temperature falls sufficiently. The junction temperature at which the thermal shutdown activates is nominally 150°C with a 17°C hysteresis.

**Monitor Register (Reg05)**

The Monitor register indicates of the regulation state of the IC. If the IC is enabled and is regulating, its value is (1000 0000).

**I<sup>2</sup>C Interface**

The FAN53555's serial interface is compatible with Standard, Fast, Fast Plus, and HS Mode I<sup>2</sup>C-Bus specifications. The FAN53555's SCL line is an input and its SDA line is a bi-directional open-drain output; it can only pull down the bus when active. The SDA line only pulls LOW during data reads and when signaling ACK. All data is shifted in MSB (bit 7) first.

**I<sup>2</sup>C Slave Address**

In hex notation, the slave address assumes a 0 LS Bit. The hex slave address is C0 for all options except -42, which has a hex slave address of C4.

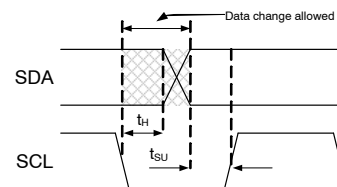
**Table 14. I<sup>2</sup>C SLAVE ADDRESS**

Option	Hex	Bits							
		7	6	5	4	3	2	1	0
00 to 24, 79	C0	1	1	0	0	0	0	0	R/ $\bar{W}$
42	C4	1	1	0	0	0	1	0	R/ $\bar{W}$

Other slave addresses can be assigned. Contact a ON Semiconductor representative.

**Bus Timing**

As shown in Figure 34, data is normally transferred when SCL is LOW. Data is clocked in on the rising edge of SCL. Typically, data transitions shortly at or after the falling edge of SCL to allow ample time for the data to set up before the next SCL rising edge.



**Figure 34. Data Transfer Timing**

Each bus transaction begins and ends with SDA and SCL HIGH. A transaction begins with a START condition, which is defined as SDA transitioning from 1 to 0 with SCL HIGH, as shown in Figure 35.

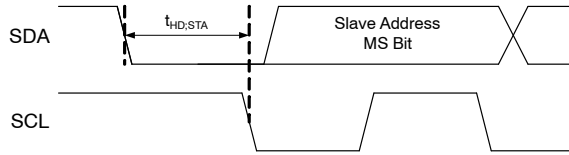


Figure 35. START Bit

A transaction ends with a STOP condition, which is defined as SDA transitioning from 0 to 1 with SCL HIGH, as shown in Figure 36.

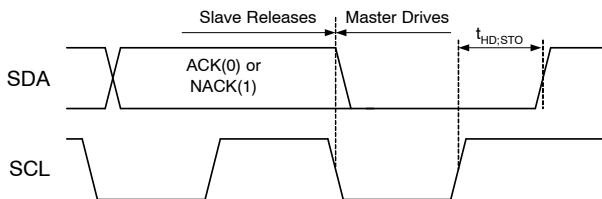


Figure 36. STOP Bit

During a read from the FAN53555, the master issues a REPEATED START after sending the register address, and before resending the slave address. The REPEATED START is a 1 to 0 transition on SDA while SCL is HIGH, as shown in Figure 37.

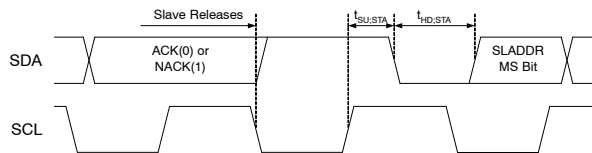


Figure 37. REPEATED START Timing

**High-Speed (HS) Mode**

The protocols for High-Speed (HS), Low-Speed (LS), and Fast-Speed (FS) Modes are identical, except the bus speed for HS mode is 3.4 MHz. HS Mode is entered when the bus master sends the HS master code 00001XXX after a START condition. The master code is sent in Fast or Fast-Plus Mode (less than 1 MHz clock); slaves do not ACK this transmission.

The master generates a REPEATED START condition ( ) that causes all slaves on the bus to switch to HS Mode. The master then sends I<sup>2</sup>C packets, as described above, using the HS Mode clock rate and timing.

The bus remains in HS Mode until a STOP bit (Figure 36) is sent by the master. While in HS Mode, packets are separated by REPEATED START conditions (Figure 37).

**Read and Write Transactions**

The following figures outline the sequences for data read and write. Bus control is signified by the shading of the packet, defined as Master Drives Bus and Slave Drives Buss. All addresses and data are MSB first.

Table 15. I<sup>2</sup>C BIT DEFINITIONS FOR FIGURE 38 AND FIGURE 39

Symbol	Definition
R	REPEATED START, <i>see</i> Figure 37
P	STOP, <i>see</i> Figure 36
S	START, <i>see</i> Figure 35
A	ACK. The slave drives SDA to 0 to acknowledge the preceding packet.
$\bar{A}$	NACK. The slave sends a 1 to NACK the preceding packet.
R	Repeated START, <i>see</i> Figure 37.
P	STOP, <i>see</i> Figure 36.

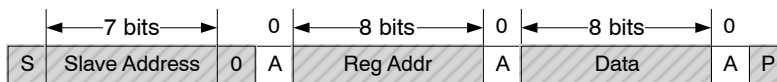


Figure 38. Write Transaction

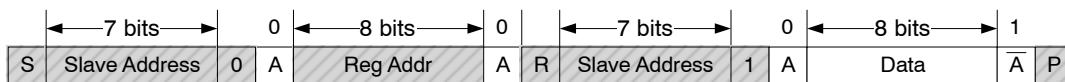


Figure 39. Read Transaction

# FAN53555

## REGISTER DESCRIPTION

Table 16. REGISTER MAP

Hex Address	Name	Function	POR Default			
			Option	V <sub>OUT</sub>	Binary	Hex
00	VSEL0	Controls V <sub>OUT</sub> settings when VSEL pin = 0	00	1.050	10101101	AD
			08, 18	1.020	10101010	AA
			01, 03, 05	0.900	10011110	9E
			04	1.100	10100111	A7
			24	1.225	10110000	B0
			13	1.150	10100011	A3
			23	1.150	10101100	AC
			09	1.100	10100111	A7
			79	0.85	10011001	99
01	VSEL1	Controls V <sub>OUT</sub> settings when VSEL pin = 1	00	1.200	11111100	FC
			01, 05	1.000	01101000	68
			04	1.200	11101111	EF
			24	1.212	10101111	AF
			08, 18	1.150	10110111	B7
			13	1.150	10100011	A3
			23	1.150	10101100	AC
			09	1.100	11100111	E7
02	CONTROL	Determines whether V <sub>OUT</sub> output discharge is enabled and also the slew rate of positive transitions	00, 01, 03, 04, 05, 24		10000000	80
			08, 09, 18		00000000	00
			13, 23		10110000	B0
03	ID1	Read-only register identifies vendor and chip type	00, 13, 23, 24		10000000	80
			01		10000001	81
			03		10000011	83
			04		10000100	84
			05		10000101	85
			08, 18		10001000	88
			09		10001100	8C
04	ID2	Read-only register identifies die revision	All		0000XXXX	0X
05	MONITOR	Indicates device status	All		X0000000	X0

# FAN53555

**Table 17. BIT DEFINITIONS**

The following table defines the operation of each register bit. Bold indicates power-on default values.

Bit	Name	Value	Description
<b>VSEL0 R/W Register Address: 00</b>			
7	BUCK_EN0	1	Software buck enable. When EN pin is LOW, the regulator is off. When EN pin is HIGH, BUCK_EN bit takes precedent.
6	MODE0	0	Allow Auto-PFM Mode during light load.
		1	Forced PWM Mode.
5:0	NSELO	00 Option 101101	Sets V <sub>OUT</sub> value from 0.6 to 1.23 V in 10 mV steps ( <i>see Eq. (2)</i> ).
		08, 18 Options 101010	
		01, 03, 05 Options 011110	
		79 Option <b>011001</b>	
		04 Option 100111	Sets V <sub>OUT</sub> value from 0.603 to 1.411 V in 12.826 mV steps ( <i>see Eq. (3)</i> ).
		09 Option 100111	
		13 Option 100011	Sets V <sub>OUT</sub> value from 0.8 to 1.43 V in 10 mV steps ( <i>see Eq. (4)</i> ).
		23 Option 101100	Sets V <sub>OUT</sub> value from 0.6 to 1.3875 V in 12.5 mV steps ( <i>see Eq. (5)</i> ).
		24 Option 110000	Sets V <sub>OUT</sub> value from 0.603 to 1.42 V in 12.967 mV steps ( <i>see Eq. (6)</i> ).
<b>VSEL1 R/W Register Address: 01</b>			
7	BUCK_EN1	00, 04, 08, 09, 13, 18, 23, 24 Options 1	Software buck enable. When EN pin is LOW, the regulator is off. When EN pin is HIGH, BUCK_EN bit takes precedent.
		01, 05 Options 0	
6	MODE1	08, 13, 18, 23, 24 Options 0	Allow AUTO-PFM Mode during light load.
		00, 01, 04, 05, 09 Options 1	Forced PWM Mode.

# FAN53555

**Table 17. BIT DEFINITIONS** (continued)

The following table defines the operation of each register bit. Bold indicates power-on default values.

Bit	Name	Value	Description
<b>VSEL1 R/W Register Address: 01</b>			
5:0	NSEL1	00 Option 111100	Sets $V_{OUT}$ value from 0.6 to 1.23 V in 10 mV steps (see Eq. (2)).
		01, 05 Options 101000	
		08, 18 Options 110111	
		04 Option 101111	Sets $V_{OUT}$ value from 0.603 to 1.411 V in 12.826 mV steps (see Eq. (3)).
		09 Option 100111	
		13 Option 100011	Sets $V_{OUT}$ value from 0.8 to 1.43 V in 10 mV steps (see Eq. (4)).
		23 Option 010100	Sets $V_{OUT}$ value from 0.6 to 1.3875 V in 12.5 mV steps (see Eq. (5)).
		24 Option 101111	Sets $V_{OUT}$ value from 0.603 to 1.42 V in 12.967 mV steps (see Eq. (6)).
<b>CONTROL R/W Register Address: 02</b>			
7	OUTPUT_DISCHARGE	08, 09, 18, 79 Options 0	When the regulator is disabled, $V_{OUT}$ is not discharged.
		00, 01, 03, 04, 05,13, 23, 24 Options 1	When the regulator is disabled, $V_{OUT}$ discharges through an internal pull-down.
6:4	SLEW	000 –111	Sets the slew rate for positive voltage transitions (see
		011	Default value for 13 and 23 options
3	Reserved	0	Always reads back 0
2	04, 09, 24, 79 Options RESET	0	Setting to 1 resets all registers to default values.
	All other options Reserved	0	Always reads back 0
1:0	Reserved	00	Always reads back 00
<b>ID1 R Register Address: 03</b>			
7:5	VENDOR	100	Signifies ON Semiconductor as the IC vendor
4	Reserved	0	Always reads back 0

# FAN53555

**Table 17. BIT DEFINITIONS** (continued)

The following table defines the operation of each register bit. Bold indicates power-on default values.

Bit	Name	Value	Description
<b>ID1 R Register Address: 03</b>			
3:0	DIE_ID	0000	IC Type = 00 Option (FAN53555UC00X / FAN53555BUC24X)
		0001	IC Type = 01 Option (FAN53555UC01X/ FAN53555BUC79X)
		0011	IC Type = 03 Option (FAN53555UC03X)
		0100	IC Type = 04 Option (FAN53555UC04X)
		0100	IC Type = 042 Option (FAN53555UC042X)
		0101	IC Type = 05 Option (FAN53555UC05X / FAN53555BUC05X)
		1000	IC Type = 08, 18 Options (FAN53555UC08X / FAN53555BUC08X, FAN53555UC18X / FAN53555BUC18X)
		1100	IC Type = 09 Option (FAN53555UC09X / FAN53555BUC09X)
		0000	IC Type = 13 Option (FAN53555UC13X / FAN53555BUC13X)
		0000	IC Type = 23 Option (FAN53555BUC23X)
<b>ID2 R Register Address: 04</b>			
7:4	Reserved	0000	Always reads back 0000
3:0	DIE_REV	00 Option	IC mask revision
		0011	
		01 Option	
		0011	
		03 Option	
		0011	
		04 Option	
		1111	
		24-Option	
		0100	
		042 Option	
		1111	
		05 Option	
0011			
08, 18 Options			
0001			
BUC08, BUC18 Options			
1111			
09 Option			
1111			
13 Option			
1111			
23 Option			
1100			
79 Option	<b>1000</b>		
<b>MONITOR R Register Address: 05</b>			
7	PGOOD	0	1: buck is enabled and soft-start is completed
6:0	Not used	000 0000	Always reads back 000 0000

APPLICATION INFORMATION

Selecting the Inductor

The output inductor must meet both the required inductance and the energy-handling capability of the application. The inductor value affects the average current limit, the output voltage ripple, and the efficiency.

The ripple current ( $\Delta I$ ) of the regulator is:

$$\Delta I = \frac{V_{OUT}}{V_{IN}} \cdot \left( \frac{V_{IN} - V_{OUT}}{L \cdot f_{sw}} \right) \quad (\text{eq. 7})$$

The maximum average load current,  $I_{MAX(Load)}$ , is related to the peak current limit,  $I_{LIM(PK)}$ , by the ripple current such that:

$$I_{MAX(Load)} = I_{LIM(PK)} - \frac{\Delta I}{2} \quad (\text{eq. 8})$$

The FAN53555 is optimized for operation with  $L = 330 \text{ nH}$ , but is stable with inductances up to  $1.0 \text{ }\mu\text{H}$  (nominal). The inductor should be rated to maintain at least 80% of its value at  $I_{LIM(PK)}$ . Failure to do so lowers the amount of DC current the IC can deliver.

Efficiency is affected by the inductor DCR and inductance value. Decreasing the inductor value for a given physical size typically decreases the DCR; but since  $\Delta I$  increases, the RMS current increases, as do core and skin-effect losses.

$$I_{RMS} = \sqrt{I_{OUT(DC)}^2 + \frac{\Delta I^2}{12}} \quad (\text{eq. 9})$$

The increased RMS current produces higher losses through the  $R_{DS(ON)}$  of the IC MOSFETs as well as the inductor ESR.

Increasing the inductor value produces lower RMS currents, but degrades transient response. For a given physical inductor size, increased inductance usually results in an inductor with lower saturation current.

**Table 18. EFFECTS OF INDUCTOR VALUE (FROM 330 nH RECOMMENDED) ON REGULATOR PERFORMANCE**

$I_{MAX(Load)}$	$\Delta V_{OUT}$ (Eq.(11))	Transient Response
Increase	Decrease	Degraded

Inductor Current Rating

The current limit circuit can allow substantial peak currents to flow through L1 under worst-case conditions. If it is possible for the load to draw such currents, the inductor should be capable of sustaining the current or failing in a safe manner.

For space-constrained applications, a lower current rating for L1 can be used. The FAN53555 may still protect these inductors in the event of a short circuit, but may not be able to protect the inductor from failure if the load is able to draw higher currents than the DC rating of the inductor.

Output Capacitor and  $V_{OUT}$  Ripple

Table 1 suggests 0805 capacitors, but 0603 capacitors may be used if space is at a premium. Due to voltage effects, the 0603 capacitors have a lower in-circuit capacitance than the 0805 package, which can degrade transient response and output ripple.

Increasing  $C_{OUT}$  has negligible effect on loop stability and can be increased to reduce output voltage ripple or to improve transient response. Output voltage ripple,  $\Delta V_{OUT}$ , is calculated by:

$$\Delta V_{OUT} = \Delta I_L \left[ \frac{f_{sw} \cdot C_{OUT} \cdot ESR^2}{2 \cdot D \cdot (1 - D)} + \frac{1}{8 \cdot f_{sw} \cdot C_{OUT}} \right] \quad (\text{eq. 10})$$

where  $C_{OUT}$  is the effective output capacitance.

The capacitance of  $C_{OUT}$  decreases at higher output voltages, which results in higher  $\Delta V_{OUT}$ . Equation (10) is only valid for Continuous Current Mode (CCM) operation, which occurs when the regulator is in PWM Mode.

For large  $C_{OUT}$  values, the regulator may fail to start under a load. If an inductor value greater than  $1.0 \text{ }\mu\text{H}$  is used, at least  $30 \text{ }\mu\text{F}$  of  $C_{OUT}$  should be used to ensure stability.

The lowest  $\Delta V_{OUT}$  is obtained when the IC is in PWM Mode and, therefore, operating at 2.4 MHz. In PFM Mode,  $f_{sw}$  is reduced, causing  $\Delta V_{OUT}$  to increase.

ESL Effects

The Equivalent Series Inductance (ESL) of the output capacitor network should be kept low to minimize the square-wave component of output ripple that results from the division ratio  $C_{OUT}$  ESL and the output inductor ( $L_{OUT}$ ). The square-wave component due to the ESL can be estimated as:

$$\Delta V_{OUT(SQ)} \approx V_{IN} \cdot \frac{ESL_{COUT}}{L1} \quad (\text{eq. 11})$$

A good practice to minimize this ripple is to use multiple output capacitors to achieve the desired  $C_{OUT}$  value. For example, to obtain  $C_{OUT} = 20 \text{ }\mu\text{F}$ , a single  $22 \text{ }\mu\text{F}$  0805 would produce twice the square wave ripple as two x  $10 \text{ }\mu\text{F}$  0805.

To minimize ESL, try to use capacitors with the lowest ratio of length to width. 0805s have lower ESL than 1206s. If low output ripple is a chief concern, some vendors produce 0508 or 0612 capacitors with ultra-low ESL. Placing additional small-value capacitors near the load also reduces the high-frequency ripple components.

Input Capacitor

The ceramic input capacitors should be placed as close as possible between the VIN pin and PGND to minimize the parasitic inductance. If a long wire is used to bring power to the IC, additional “bulk” capacitance (electrolytic or

tantalum) should be placed between  $C_{IN}$  and the power source lead to reduce under-damped ringing that can occur between the inductance of the power source leads and  $C_{IN}$ .

The effective  $C_{IN}$  capacitance value decreases as  $V_{IN}$  increases due to DC bias effects. This has no significant impact on regulator performance.

**Thermal Considerations**

Heat is removed from the IC through the solder bumps to the PCB copper. The junction-to-ambient thermal resistance ( $\theta_{JA}$ ) is largely a function of the PCB layout (size, copper weight, and trace width) and the temperature rise from junction to ambient ( $\Delta T$ ).

For the FAN53555UC,  $\theta_{JA}$  is 38°C/W when mounted on its four-layer evaluation board in still air with two-ounce outer layer copper weight and one-ounce inner layers. Halving the copper thickness results in an increased  $\theta_{JA}$  of 48°C/W.

For long-term reliable operation, the IC's junction temperature ( $T_j$ ) should be maintained below 125°C.

To calculate maximum operating temperature ( $\leq 125^\circ\text{C}$ ) for a specific application:

1. Use efficiency graphs to determine efficiency for the desired  $V_{IN}$ ,  $V_{OUT}$ , and load conditions.

2. Calculate total power dissipation using:

$$P_T = V_{OUT} \times I_{LOAD} \times \left(\frac{1}{\eta} - 1\right) \quad (\text{eq. 12})$$

where  $\eta$  is efficiency from Figure 7 through Figure 12.

3. Estimate inductor copper losses using:

$$P_L = I_{LOAD}^2 \times DCR_L \quad (\text{eq. 13})$$

4. Determine IC losses by removing inductor losses (step 3) from total dissipation:

$$P_{IC} = P_T - P_L \quad (\text{eq. 14})$$

5. Determine device operating temperature:

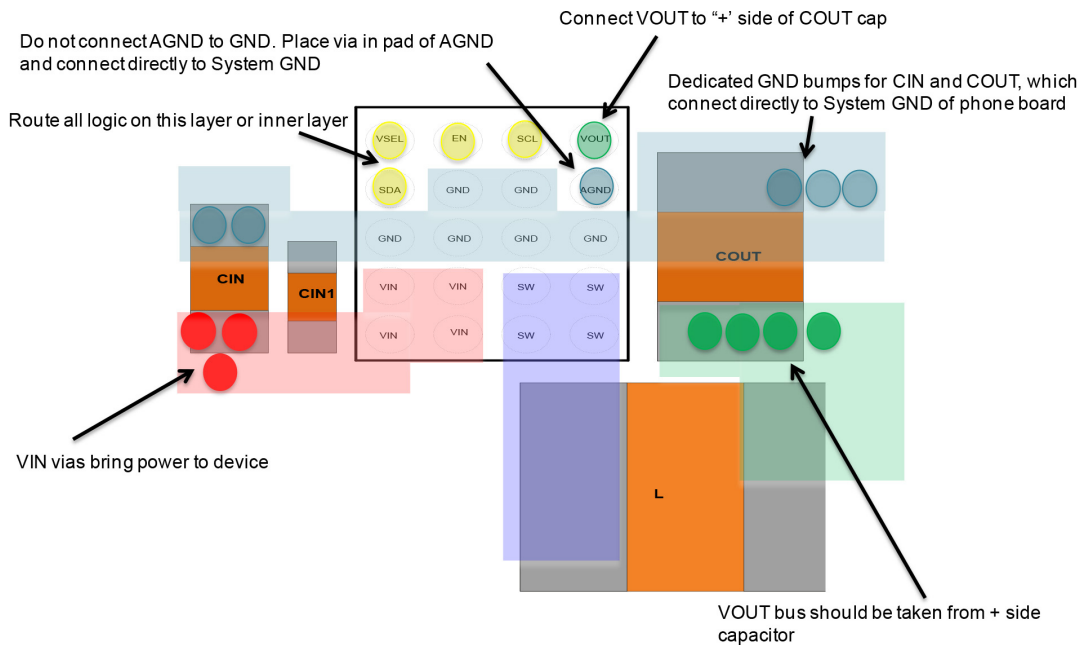
$$\Delta T = P_{IC} \times \theta_{size7JA} \quad (\text{eq. 15})$$

and

$$T_{IC} = T_A + \Delta T \quad (\text{eq. 16})$$

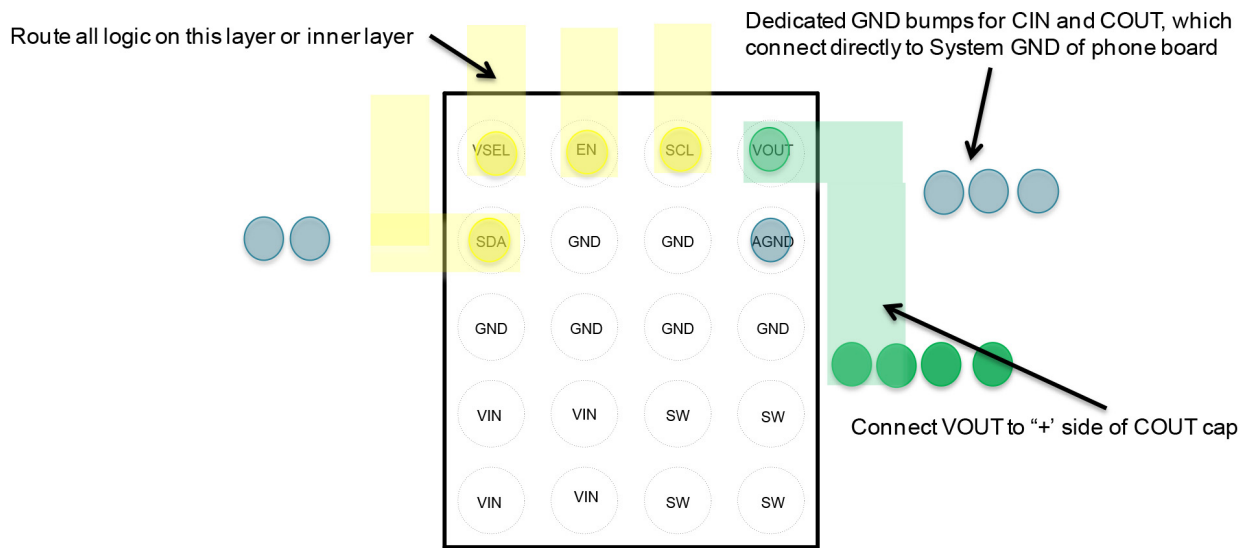
It is important to note that the  $R_{DS(ON)}$  of the IC's power MOSFETs increases linearly with temperature at about 1.21%/°C. This causes the efficiency ( $\eta$ ) to degrade with increasing die temperature.

**LAYOTUT RECOMMENDATION**

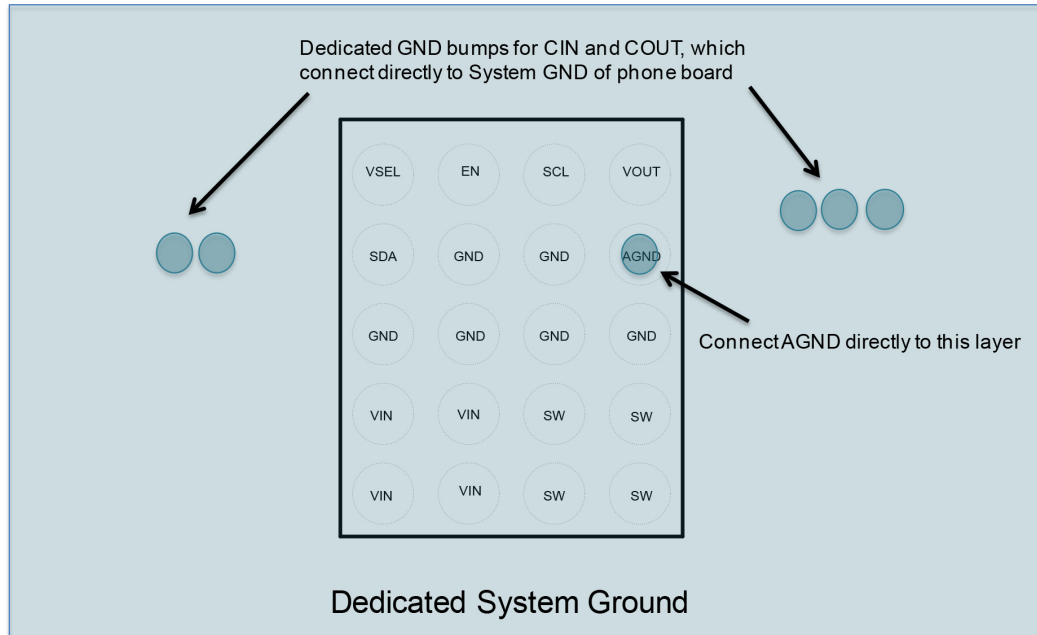


**Figure 40. Guidance for Layer 1**

# FAN53555



**Figure 41. Guidance for Layer 2**



**Figure 42. Guidance for Layer 3**

# FAN53555

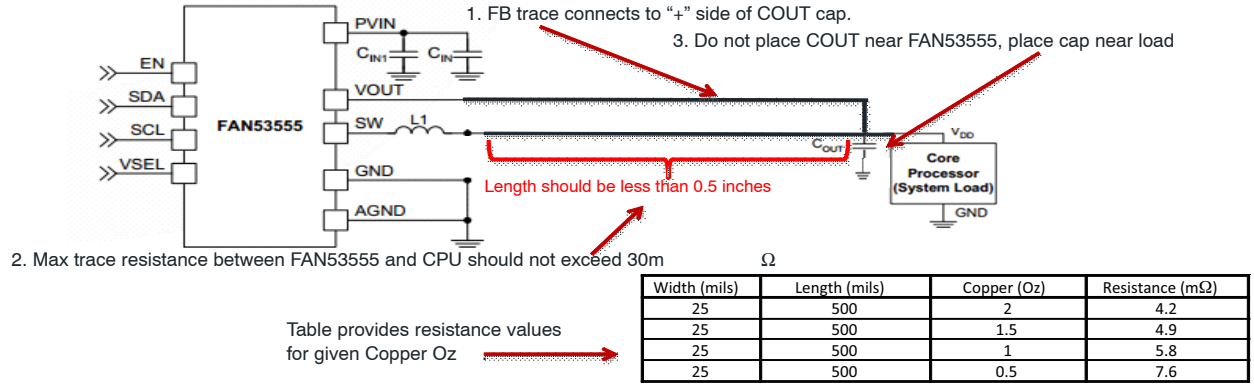


Figure 43. Remote Sensing Schematic

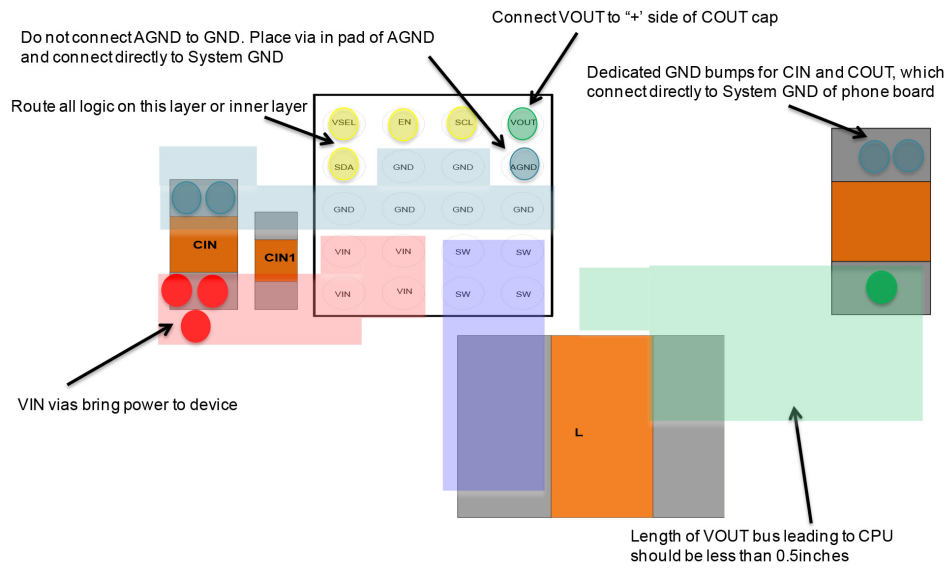


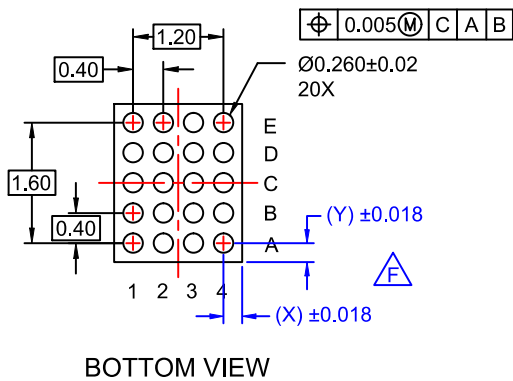
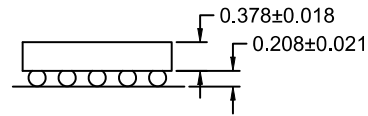
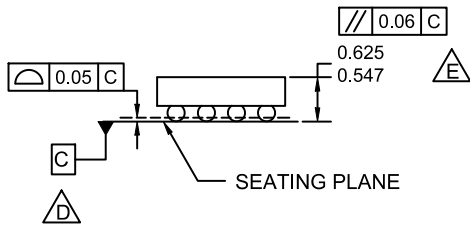
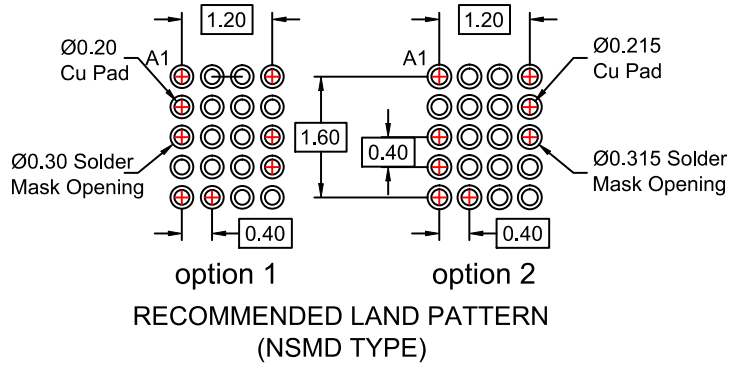
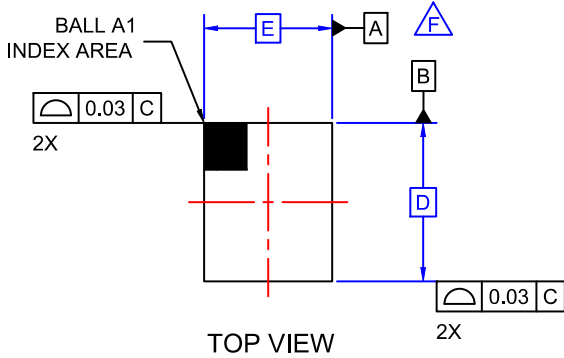
Figure 44. Remote Sensing Guidance, Top Layer

Table 19. Product-Specific Dimensions

Product	D	E	X	Y	Land Pattern
FAN53555UC00 to FAN53555UC08X, FAN53555BUC05X	2.000 ±0.03	1.600 ±0.03	0.200	0.200	Option 1
FAN53555BUC08X, FAN53555BUC09X, FAN53555UC09X, FAN53555UC13X, FAN53555BUC13X, FAN53555UC18X, FAN53555BUC18X, FAN53555BUC23X, FAN53555UC24X, FAN53555BUC24X, FAN53555BUC79X	2.015 ±0.03	1.615 ±0.03	0.2075	0.2075	Option 2

**WLCSP20 2.015x1.615x0.586**  
CASE 567QK  
ISSUE O

DATE 31 OCT 2016



**NOTES:**

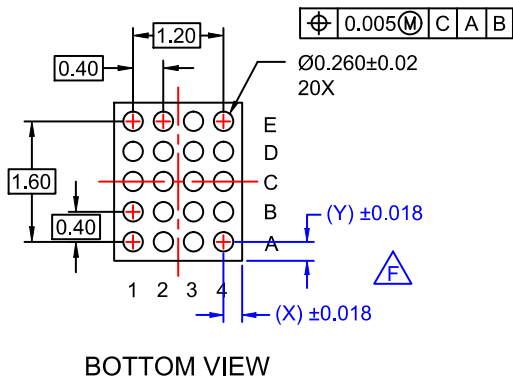
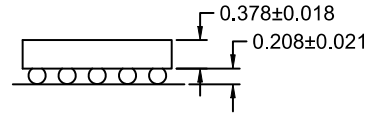
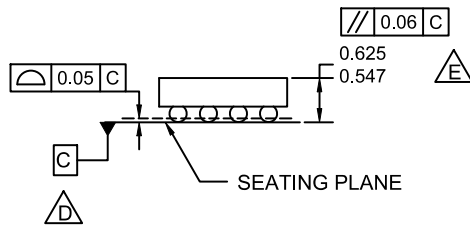
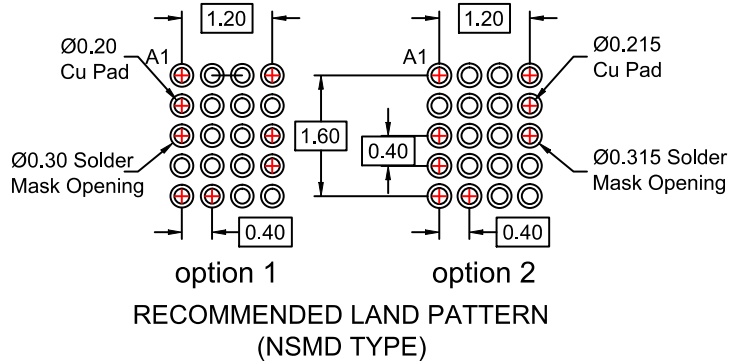
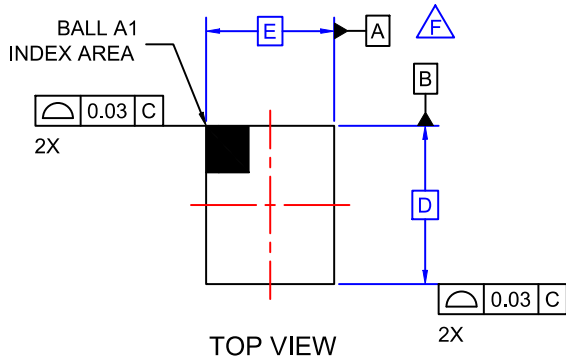
- A. NO JEDEC REGISTRATION APPLIES.
- B. DIMENSIONS ARE IN MILLIMETERS.
- C. DIMENSIONS AND TOLERANCE PER ASMEY14.5M, 2009.
- D. DATUM C IS DEFINED BY THE SPHERICAL CROWNS OF THE BALLS.
- E. PACKAGE NOMINAL HEIGHT IS 586 MICRONS ±39 MICRONS (547-625 MICRONS).
- F. FOR DIMENSIONS D, E, X, AND Y SEE PRODUCT DATASHEET.

<b>DOCUMENT NUMBER:</b>	<b>98AON13330G</b>	Electronic versions are uncontrolled except when accessed directly from the Document Repository. Printed versions are uncontrolled except when stamped "CONTROLLED COPY" in red.
<b>STATUS:</b>	<b>ON SEMICONDUCTOR STANDARD</b>	
<b>NEW STANDARD:</b>		
<b>DESCRIPTION:</b>	<b>WLCSP20 2.015x1.615x0.586</b>	<b>PAGE 1 OF 2</b>



**WLCSP20 2.015x1.615x0.586**  
CASE 567SH  
ISSUE O

DATE 30 NOV 2016



**NOTES:**

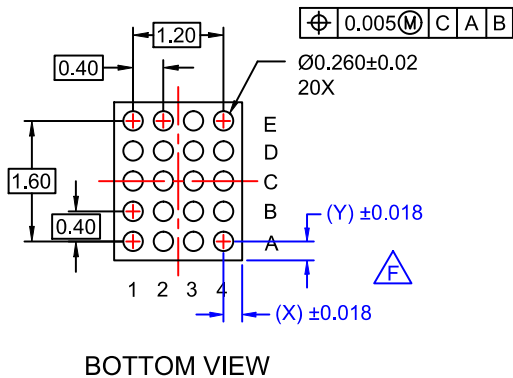
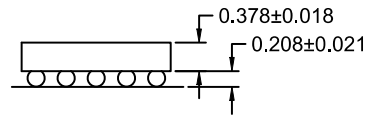
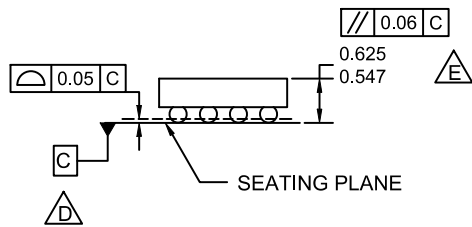
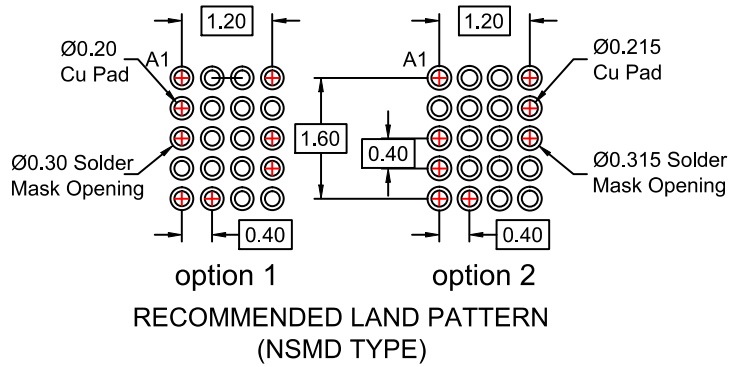
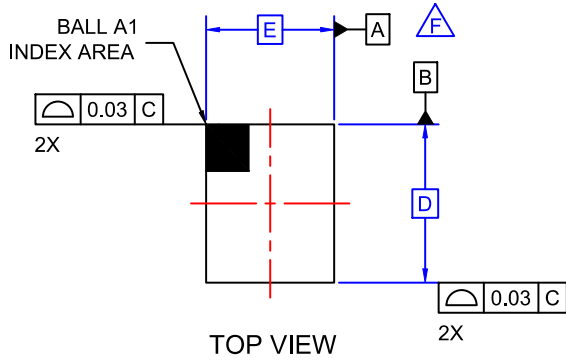
- A. NO JEDEC REGISTRATION APPLIES.
- B. DIMENSIONS ARE IN MILLIMETERS.
- C. DIMENSIONS AND TOLERANCE PER ASMEY14.5M, 2009.
- D.** DATUM C IS DEFINED BY THE SPHERICAL CROWNS OF THE BALLS.
- E.** PACKAGE NOMINAL HEIGHT IS 586 MICRONS ±39 MICRONS (547-625 MICRONS).
- F.** FOR DIMENSIONS D, E, X, AND Y SEE PRODUCT DATASHEET.

<b>DOCUMENT NUMBER:</b>	<b>98AON16602G</b>	Electronic versions are uncontrolled except when accessed directly from the Document Repository. Printed versions are uncontrolled except when stamped "CONTROLLED COPY" in red.
<b>STATUS:</b>	<b>ON SEMICONDUCTOR STANDARD</b>	
<b>NEW STANDARD:</b>		
<b>DESCRIPTION:</b>	<b>WLCSP20 2.015x1.615x0.586</b>	<b>PAGE 1 OF 2</b>



**WLCSP20 2.0x1.6x0.586**  
CASE 567SK  
ISSUE O

DATE 30 NOV 2016




**NOTES:**

- A. NO JEDEC REGISTRATION APPLIES.
- B. DIMENSIONS ARE IN MILLIMETERS.
- C. DIMENSIONS AND TOLERANCE PER ASMEY14.5M, 2009.
- D. DATUM C IS DEFINED BY THE SPHERICAL CROWNS OF THE BALLS.
- E. PACKAGE NOMINAL HEIGHT IS 586 MICRONS ±39 MICRONS (547-625 MICRONS).
- F. FOR DIMENSIONS D, E, X, AND Y SEE PRODUCT DATASHEET.

<b>DOCUMENT NUMBER:</b>	<b>98AON16604G</b>	Electronic versions are uncontrolled except when accessed directly from the Document Repository. Printed versions are uncontrolled except when stamped "CONTROLLED COPY" in red.
<b>STATUS:</b>	<b>ON SEMICONDUCTOR STANDARD</b>	
<b>NEW STANDARD:</b>		
<b>DESCRIPTION:</b>	<b>WLCSP20 2.0x1.6x0.586</b>	<b>PAGE 1 OF 2</b>



ON Semiconductor and  are trademarks of Semiconductor Components Industries, LLC dba ON Semiconductor or its subsidiaries in the United States and/or other countries. ON Semiconductor owns the rights to a number of patents, trademarks, copyrights, trade secrets, and other intellectual property. A listing of ON Semiconductor's product/patent coverage may be accessed at [www.onsemi.com/site/pdf/Patent-Marking.pdf](http://www.onsemi.com/site/pdf/Patent-Marking.pdf). ON Semiconductor reserves the right to make changes without further notice to any products herein. ON Semiconductor makes no warranty, representation or guarantee regarding the suitability of its products for any particular purpose, nor does ON Semiconductor assume any liability arising out of the application or use of any product or circuit, and specifically disclaims any and all liability, including without limitation special, consequential or incidental damages. Buyer is responsible for its products and applications using ON Semiconductor products, including compliance with all laws, regulations and safety requirements or standards, regardless of any support or applications information provided by ON Semiconductor. "Typical" parameters which may be provided in ON Semiconductor data sheets and/or specifications can and do vary in different applications and actual performance may vary over time. All operating parameters, including "Typicals" must be validated for each customer application by customer's technical experts. ON Semiconductor does not convey any license under its patent rights nor the rights of others. ON Semiconductor products are not designed, intended, or authorized for use as a critical component in life support systems or any FDA Class 3 medical devices or medical devices with a same or similar classification in a foreign jurisdiction or any devices intended for implantation in the human body. Should Buyer purchase or use ON Semiconductor products for any such unintended or unauthorized application, Buyer shall indemnify and hold ON Semiconductor and its officers, employees, subsidiaries, affiliates, and distributors harmless against all claims, costs, damages, and expenses, and reasonable attorney fees arising out of, directly or indirectly, any claim of personal injury or death associated with such unintended or unauthorized use, even if such claim alleges that ON Semiconductor was negligent regarding the design or manufacture of the part. ON Semiconductor is an Equal Opportunity/Affirmative Action Employer. This literature is subject to all applicable copyright laws and is not for resale in any manner.

## PUBLICATION ORDERING INFORMATION

### LITERATURE FULFILLMENT:

Literature Distribution Center for ON Semiconductor  
19521 E. 32nd Pkwy, Aurora, Colorado 80011 USA  
**Phone:** 303-675-2175 or 800-344-3860 Toll Free USA/Canada  
**Fax:** 303-675-2176 or 800-344-3867 Toll Free USA/Canada  
**Email:** [orderlit@onsemi.com](mailto:orderlit@onsemi.com)

**N. American Technical Support:** 800-282-9855 Toll Free  
USA/Canada  
**Europe, Middle East and Africa Technical Support:**  
Phone: 421 33 790 2910

**ON Semiconductor Website:** [www.onsemi.com](http://www.onsemi.com)

**Order Literature:** <http://www.onsemi.com/orderlit>

For additional information, please contact your local  
Sales Representative

## Looking for pricing, stock, or lifecycle information?

Click below to explore more details on WIN SOURCE:

- ⊖ [View FAN53555UC18X on WIN SOURCE](#)
- ⊖ [Fairchild/ON Semiconductor Information](#)

## Optimize Your Supply Chain with WIN SOURCE Solutions

- ✓ Global Sourcing Solution
- ✓ Obsolete Management
- ✓ Cost Control Management
- ✓ Shortage Management
- ✓ Alternative Solution
- ✓ Excess Inventory Management