



**THE DATASHEET OF  
AD7685CRMZRL7**



### FEATURES

- 16-bit resolution with no missing codes
- Throughput: 250 kSPS
- INL:  $\pm 0.6$  LSB typical,  $\pm 2$  LSB maximum ( $\pm 0.003\%$  of FSR)
- SINAD: 93.5 dB at 20 kHz
- THD:  $-110$  dB at 20 kHz
- Pseudo differential analog input range  
0 V to  $V_{REF}$  with  $V_{REF}$  up to VDD
- No pipeline delay
- Single-supply operation 2.3 V to 5.5 V with  
1.8 V to 5 V logic interface
- Proprietary serial interface: SPI-/QSPI™-/MICROWIRE™-/DSP-  
compatible
- Daisy-chain multiple ADCs, BUSY indicator
- Power dissipation  
1.4  $\mu$ W at 2.5 V/100 SPS  
1.35 mW at 2.5 V/100 kSPS, 4 mW at 5 V/100 kSPS
- Standby current: 1 nA
- 10-lead package: MSOP (MSOP-8 size) and  
3 mm  $\times$  3 mm LFCSP (SOT-23 size)
- Pin-for-pin-compatible with 10-lead MSOP/PuISAR® ADCs

### APPLICATIONS

- Battery-powered equipment
  - Medical instruments
  - Mobile communications
  - Personal digital assistants (PDAs)
- Data acquisition
- Instrumentation
- Process controls

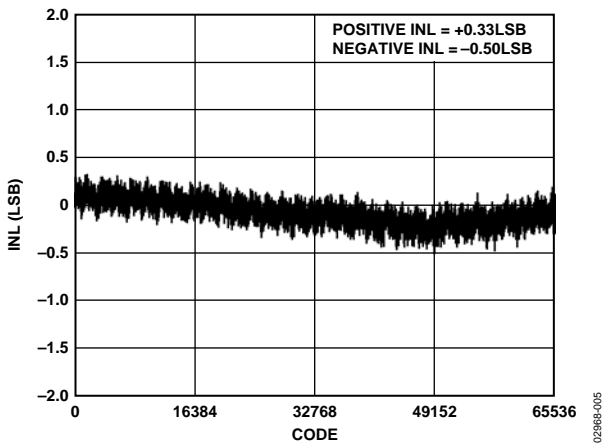

Figure 1. Integral Nonlinearity vs. Code

### TYPICAL APPLICATION CIRCUIT

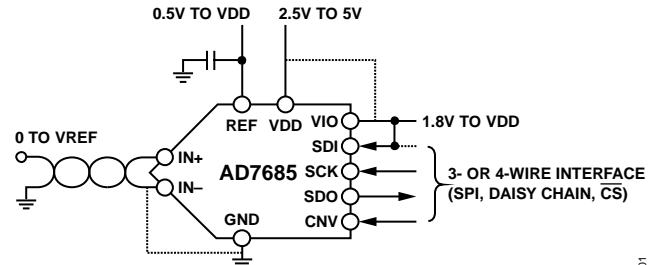

Figure 2.

Table 1. MSOP, LFCSP/SOT-23 14-/16-/18-Bit PuISAR ADC

Type	100 kSPS	250 kSPS	400 kSPS to 500 kSPS	1000 kSPS	ADC Driver
18-Bit True Differential		AD7691	AD7690 AD7982	AD7982	ADA4941 ADA4841
16-Bit True Differential	AD7684	AD7687	AD7688 AD7693		ADA4941 ADA4841
16-Bit Pseudo Differential	AD7680 AD7683	AD7685 AD7694	AD7686	AD7980	ADA4841
14-Bit Pseudo Differential	AD7940	AD7942	AD7946		ADA4841

### GENERAL DESCRIPTION

The AD7685<sup>1</sup> is a 16-bit, charge redistribution successive approximation, analog-to-digital converter (ADC) that operates from a single power supply, VDD, between 2.3 V to 5.5 V. It contains a low power, high speed, 16-bit sampling ADC with no missing codes, an internal conversion clock, and a versatile serial interface port. The part also contains a low noise, wide bandwidth, short aperture delay, track-and-hold circuit. On the CNV rising edge, it samples an analog input IN+ between 0 V to REF with respect to a ground sense IN-. The reference voltage, REF, is applied externally and can be set up to the supply voltage.

Power dissipation scales linearly with throughput.

The SPI-compatible serial interface also features the ability, using the SDI input, to daisy chain several ADCs on a single 3-wire bus or provides an optional BUSY indicator. It is compatible with 1.8 V, 2.5 V, 3 V, or 5 V logic using the separate supply VIO.

The AD7685 is housed in a 10-lead MSOP or a 10-lead LFCSP with operation specified from  $-40^{\circ}\text{C}$  to  $+85^{\circ}\text{C}$ .

<sup>1</sup> Protected by U.S. Patent 6,703,961.

## TABLE OF CONTENTS

Features .....	1	Driver Amplifier Choice .....	16
Applications .....	1	Voltage Reference Input .....	16
Typical Application Circuit .....	1	Power Supply .....	16
General Description .....	1	Supplying the ADC from the Reference .....	17
Revision History .....	2	Digital Interface .....	17
Specifications .....	3	$\overline{\text{CS}}$ Mode 3-Wire, No BUSY Indicator .....	18
Timing Specifications .....	5	$\overline{\text{CS}}$ Mode 3-Wire with BUSY Indicator .....	19
Absolute Maximum Ratings .....	7	$\overline{\text{CS}}$ Mode 4-Wire, No BUSY Indicator .....	20
ESD Caution .....	7	$\overline{\text{CS}}$ Mode 4-Wire with BUSY Indicator .....	21
Pin Configuration and Function Descriptions .....	8	Chain Mode, No BUSY Indicator .....	22
Terminology .....	9	Chain Mode with BUSY Indicator .....	23
Typical Performance Characteristics .....	10	Application Hints .....	24
Theory of Operation .....	13	Layout .....	24
Circuit Information .....	13	Evaluating the Performance of the AD7685 .....	24
Converter Operation .....	13	True 16-Bit Isolated Application Example .....	25
Typical Connection Diagram .....	14	Outline Dimensions .....	26
Analog Inputs .....	15	Ordering Guide .....	27

## REVISION HISTORY

### 7/14—Rev. C to Rev. D

Deleted QFN .....	Throughout
Changed Application Diagram to Typical Application Circuit .....	1
Change to Features Section .....	1
Added Patent Note, Note 1 .....	1
Changes to Evaluating the Performance of the AD7685 Section .....	24
Updated Outline Dimensions .....	26
Changes to Ordering Guide .....	27

### 8/11—Rev. B to Rev. C

Changes to Figure 6 and Table 7 .....	8
Updated Outline Dimensions .....	26
Changes to Ordering Guide .....	27

### 3/07—Rev. A to Rev. B

Changes to Features and Table 1 .....	1
Changes to Table 3 .....	4
Moved Figure 3 and Figure 4 to Page .....	6
Inserted Figure 6; Renumbered Sequentially .....	8
Changes to Figure 13 and Figure 14 .....	11

Changes to Figure 27 .....	14
Changes to Table 9 .....	16
Changes to Figure 32 .....	17
Changes to Figure 43 .....	22
Changes to Figure 45 .....	23
Updated Outline Dimensions .....	26
Changes to Ordering Guide .....	27

### 12/04—Rev. 0 to Rev. A

Changes to Specifications .....	3
Changes to Figure 17 Captions .....	11
Changes to Power Supply Section .....	17
Changes to Digital Interface Section .....	18
Changes to $\overline{\text{CS}}$ Mode 4-Wire No Busy Indicator Section .....	21
Changes to $\overline{\text{CS}}$ Mode 4-Wire with Busy Indicator Section .....	22
Changes to Chain Mode, No Busy Indicator Section .....	23
Changes to Chain Mode with Busy Indicator Section .....	24
Added True 16-Bit Isolated Application Example Section .....	26
Added Figure 47 .....	26
Changes to Ordering Guide .....	28

### 4/04—Revision 0: Initial Revision

## SPECIFICATIONS

VDD = 2.3 V to 5.5 V, VIO = 2.3 V to VDD, VREF = VDD, TA = -40°C to +85°C, unless otherwise noted.

Table 2.

Parameter	Test Conditions	A Grade			B Grade			C Grade			Unit
		Min	Typ	Max	Min	Typ	Max	Min	Typ	Max	
RESOLUTION		16			16			16			Bits
ANALOG INPUT											
Voltage Range	IN+ – IN–	0		VREF	0		VREF	0		VREF	V
Absolute Input Voltage	IN+	-0.1		VDD + 0.1	-0.1		VDD + 0.1	-0.1		VDD + 0.1	V
	IN–	-0.1		+0.1	-0.1		+0.1	-0.1		+0.1	V
Analog Input CMRR	f <sub>IN</sub> = 250 kHz		65			65			65		dB
Leakage Current at 25°C	Acquisition phase		1			1			1		nA
Input Impedance			See the Analog Inputs section			See the Analog Inputs section			See the Analog Inputs section		
ACCURACY											
No Missing Codes		15			16			16			Bits
Differential Linearity Error					-1	±0.7		-1	±0.5	+1.5	LSB <sup>1</sup>
Integral Linearity Error		-6		+6	-3	±1	+3	-2	±0.6	+2	LSB
Transition Noise	REF = VDD = 5 V		0.5			0.5			0.45		LSB
Gain Error <sup>2</sup> , T <sub>MIN</sub> to T <sub>MAX</sub>			±2	±30		±2	±30		±2	±15	LSB
Gain Error Temperature Drift			±0.3			±0.3			±0.3		ppm/°C
Offset Error <sup>2</sup> , T <sub>MIN</sub> to T <sub>MAX</sub>	VDD = 4.5 V to 5.5 V		±0.1	±1.6		±0.1	±1.6		±0.1	±1.6	mV
	VDD = 2.3 V to 4.5 V		±0.7	±3.5		±0.7	±3.5		±0.7	±3.5	mV
Offset Temperature Drift			±0.3			±0.3			±0.3		ppm/°C
Power Supply Sensitivity	VDD = 5 V ± 5%		±0.05			±0.05			±0.05		LSB
THROUGHPUT											
Conversion Rate	VDD = 4.5 V to 5.5 V	0		250	0		250	0		250	kSPS
	VDD = 2.3 V to 4.5 V	0		200	0		200	0		200	kSPS
Transient Response	Full-scale step			1.8			1.8			1.8	µs
AC ACCURACY											
Signal-to-Noise Ratio	f <sub>IN</sub> = 20 kHz, V <sub>REF</sub> = 5 V		90		90	92		91.5	93.5		dB <sup>3</sup>
	f <sub>IN</sub> = 20 kHz, V <sub>REF</sub> = 2.5 V		86		86	88		87.5	88.5		dB
Spurious-Free Dynamic Range	f <sub>IN</sub> = 20 kHz		-100			-106			-110		dB
Total Harmonic Distortion	f <sub>IN</sub> = 20 kHz		-100			-106			-110		dB
Signal-to-(Noise + Distortion)	f <sub>IN</sub> = 20 kHz, V <sub>REF</sub> = 5 V		89		90	92		91.5	93.5		dB
	f <sub>IN</sub> = 20 kHz, V <sub>REF</sub> = 5 V, -60 dB input					32			33.5		dB
	f <sub>IN</sub> = 20 kHz, V <sub>REF</sub> = 2.5 V		86		85.5	87.5		87	88.5		dB
Intermodulation Distortion <sup>4</sup>						-110			-115		dB

<sup>1</sup> LSB means least significant bit. With the 5 V input range, 1 LSB is 76.3 µV.

<sup>2</sup> See Terminology section. These specifications do include full temperature range variation but do not include the error contribution from the external reference.

<sup>3</sup> All specifications in dB are referred to a full-scale input FS. Tested with an input signal at 0.5 dB below full-scale, unless otherwise specified.

<sup>4</sup> f<sub>IN1</sub> = 21.4 kHz, f<sub>IN2</sub> = 18.9 kHz, each tone at -7 dB below full scale.

VDD = 2.3 V to 5.5 V, VIO = 2.3 V to VDD, VREF = VDD, TA = -40°C to +85°C, unless otherwise noted.

Table 3.

Parameter	Test Conditions/Comments	Min	Typ	Max	Unit
REFERENCE					
Voltage Range		0.5		VDD + 0.3	V
Load Current	250 kSPS, REF = 5 V		50		μA
SAMPLING DYNAMICS					
-3 dB Input Bandwidth			2		MHz
Aperture Delay	VDD = 5 V		2.5		ns
DIGITAL INPUTS					
Logic Levels					
V <sub>IL</sub>		-0.3		0.3 × VIO	V
V <sub>IH</sub>		0.7 × VIO		VIO + 0.3	V
I <sub>IL</sub>		-1		+1	μA
I <sub>IH</sub>		-1		+1	μA
DIGITAL OUTPUTS					
Data Format		Serial 16 bits straight binary			
Pipeline Delay		Conversion results available immediately after completed conversion			
V <sub>OL</sub>	I <sub>SINK</sub> = +500 μA			0.4	V
V <sub>OH</sub>	I <sub>SOURCE</sub> = -500 μA	VIO - 0.3			V
POWER SUPPLIES					
VDD	Specified performance	2.3		5.5	V
VIO	Specified performance	2.3		VDD + 0.3	V
VIO Range		1.8		VDD + 0.3	V
Standby Current <sup>1, 2</sup>	VDD and VIO = 5 V, 25°C		1	50	nA
Power Dissipation	VDD = 2.5 V, 100 SPS throughput		1.4		μW
	VDD = 2.5 V, 100 kSPS throughput		1.35	2.4	mW
	VDD = 2.5 V, 200 kSPS throughput		2.7	4.8	mW
	VDD = 5 V, 100 kSPS throughput		4	6	mW
	VDD = 5 V, 250 kSPS throughput		10	15	mW
TEMPERATURE RANGE <sup>3</sup>					
Specified Performance	T <sub>MIN</sub> to T <sub>MAX</sub>	-40		+85	°C

<sup>1</sup> With all digital inputs forced to VIO or GND as required.

<sup>2</sup> During acquisition phase.

<sup>3</sup> Contact sales for extended temperature range.

## TIMING SPECIFICATIONS

−40°C to +85°C, VIO = 2.3 V to 5.5 V or VDD + 0.3 V, whichever is the lowest, unless otherwise stated.

**Table 4. VDD = 4.5 V to 5.5 V<sup>1</sup>**

Parameter	Symbol	Min	Typ	Max	Unit
Conversion Time: CNV Rising Edge To Data Available	t <sub>CONV</sub>	0.5		2.2	μs
Acquisition Time	t <sub>ACQ</sub>	1.8			μs
Time Between Conversions	t <sub>CYC</sub>	4			μs
CNV Pulse Width ( $\overline{CS}$ Mode)	t <sub>CNVH</sub>	10			ns
SCK Period ( $\overline{CS}$ Mode)	t <sub>SCK</sub>	15			ns
SCK Period (Chain Mode)	t <sub>SCK</sub>				
VIO Above 4.5 V		17			ns
VIO Above 3 V		18			ns
VIO Above 2.7 V		19			ns
VIO Above 2.3 V		20			ns
SCK Low Time	t <sub>SCKL</sub>	7			ns
SCK High Time	t <sub>SCKH</sub>	7			ns
SCK Falling Edge to Data Remains Valid	t <sub>HSDO</sub>	5			ns
SCK Falling Edge to Data Valid Delay	t <sub>DSDO</sub>				
VIO Above 4.5 V				14	ns
VIO Above 3 V				15	ns
VIO Above 2.7 V				16	ns
VIO Above 2.3 V				17	ns
CNV or SDI Low to SDO D15 MSB Valid ( $\overline{CS}$ Mode)	t <sub>EN</sub>				
VIO Above 4.5 V				15	ns
VIO Above 2.7 V				18	ns
VIO Above 2.3 V				22	ns
CNV or SDI High or Last SCK Falling Edge to SDO High Impedance ( $\overline{CS}$ Mode)	t <sub>DIS</sub>			25	ns
SDI Valid Setup Time from CNV Rising Edge ( $\overline{CS}$ Mode)	t <sub>SSDICNV</sub>	15			ns
SDI Valid Hold Time from CNV Rising Edge ( $\overline{CS}$ Mode)	t <sub>HSDICNV</sub>	0			ns
SCK Valid Setup Time from CNV Rising Edge (Chain Mode)	t <sub>SSCKCNV</sub>	5			ns
SCK Valid Hold Time from CNV Rising Edge (Chain Mode)	t <sub>HSCCKCNV</sub>	5			ns
SDI Valid Setup Time from SCK Falling Edge (Chain Mode)	t <sub>SSDISCK</sub>	3			ns
SDI Valid Hold Time from SCK Falling Edge (Chain Mode)	t <sub>HSDISCK</sub>	4			ns
SDI High to SDO High (Chain Mode with Busy Indicator)	t <sub>DSDOSDI</sub>				
VIO Above 4.5 V				15	ns
VIO Above 2.3 V				26	ns

<sup>1</sup> See Figure 3 and Figure 4 for load conditions.

-40°C to +85°C, VIO = 2.3 V to 4.5 V or VDD + 0.3 V, whichever is the lowest, unless otherwise stated.

Table 5. VDD = 2.3V to 4.5 V<sup>1</sup>

Parameter	Symbol	Min	Typ	Max	Unit
Conversion Time: CNV Rising Edge to Data Available	t <sub>CONV</sub>	0.7		3.2	μs
Acquisition Time	t <sub>ACQ</sub>	1.8			μs
Time Between Conversions	t <sub>CYC</sub>	5			μs
CNV Pulse Width (CS Mode)	t <sub>CNVH</sub>	10			ns
SCK Period (CS Mode)	t <sub>SCK</sub>	25			ns
SCK Period (Chain Mode)	t <sub>SCK</sub>				
VIO Above 3 V		29			ns
VIO Above 2.7 V		35			ns
VIO Above 2.3 V		40			ns
SCK Low Time	t <sub>SCKL</sub>	12			ns
SCK High Time	t <sub>SCKH</sub>	12			ns
SCK Falling Edge to Data Remains Valid	t <sub>HSDO</sub>	5			ns
SCK Falling Edge to Data Valid Delay	t <sub>DSDO</sub>				
VIO Above 3 V				24	ns
VIO Above 2.7 V				30	ns
VIO Above 2.3 V				35	ns
CNV or SDI Low to SDO D15 MSB Valid (CS Mode)	t <sub>EN</sub>				
VIO Above 2.7 V				18	ns
VIO Above 2.3 V				22	ns
CNV or SDI High or Last SCK Falling Edge to SDO High Impedance (CS Mode)	t <sub>DIS</sub>			25	ns
SDI Valid Setup Time from CNV Rising Edge (CS Mode)	t <sub>SSDICNV</sub>	30			ns
SDI Valid Hold Time from CNV Rising Edge (CS Mode)	t <sub>HSDICNV</sub>	0			ns
SCK Valid Setup Time from CNV Rising Edge (Chain Mode)	t <sub>SSCKCNV</sub>	5			ns
SCK Valid Hold Time from CNV Rising Edge (Chain Mode)	t <sub>HSCKCNV</sub>	8			ns
SDI Valid Setup Time from SCK Falling Edge (Chain Mode)	t <sub>SSDISCK</sub>	5			ns
SDI Valid Hold Time from SCK Falling Edge (Chain Mode)	t <sub>HSDISCK</sub>	4			ns
SDI High to SDO High (Chain Mode with Busy Indicator)	t <sub>DSDOSDI</sub>			36	ns

<sup>1</sup> See Figure 3 and Figure 4 for load conditions.

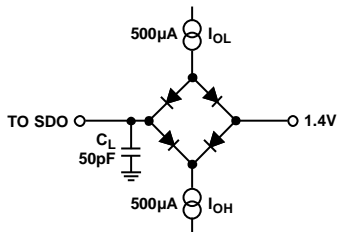
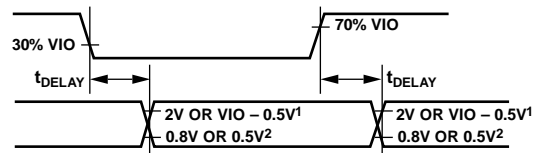

Figure 3. Load Circuit for Digital Interface Timing



NOTES  
 1. 2V IF VIO ABOVE 2.5V, VIO - 0.5V IF VIO BELOW 2.5V.  
 2. 0.8V IF VIO ABOVE 2.5V, 0.5V IF VIO BELOW 2.5V.

02988B-003

## ABSOLUTE MAXIMUM RATINGS

Table 6.

Parameter	Rating
Analog Inputs IN <sup>+</sup> <sup>1</sup> , IN <sup>-</sup> <sup>1</sup> , REF	GND – 0.3 V to VDD + 0.3 V or ±130 mA
Supply Voltages VDD, VIO to GND VDD to VIO	–0.3 V to +7 V ±7 V
Digital Inputs to GND	–0.3 V to VIO + 0.3 V
Digital Outputs to GND	–0.3 V to VIO + 0.3 V
Storage Temperature Range	–65°C to +150°C
Junction Temperature	150°C
θ <sub>JA</sub> Thermal Impedance	200°C/W (MSOP-10)
θ <sub>JC</sub> Thermal Impedance	44°C/W (MSOP-10)
Lead Temperature	
Vapor Phase (60 sec)	215°C
Infrared (15 sec)	220°C

<sup>1</sup> See the Analog Inputs section.

Stresses above those listed under Absolute Maximum Ratings may cause permanent damage to the device. This is a stress rating only; functional operation of the device at these or any other conditions above those indicated in the operational section of this specification is not implied. Exposure to absolute maximum rating conditions for extended periods may affect device reliability.

### ESD CAUTION



**ESD (electrostatic discharge) sensitive device.** Charged devices and circuit boards can discharge without detection. Although this product features patented or proprietary protection circuitry, damage may occur on devices subjected to high energy ESD. Therefore, proper ESD precautions should be taken to avoid performance degradation or loss of functionality.

## PIN CONFIGURATION AND FUNCTION DESCRIPTIONS

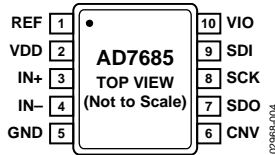
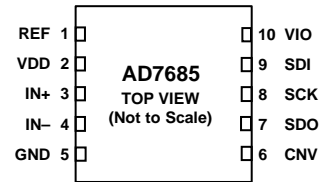

Figure 5. 10-Lead MSOP Pin Configuration



NOTES  
1. EXPOSED PAD CONNECTED TO GND. THIS CONNECTION IS NOT REQUIRED TO MEET THE ELECTRICAL PERFORMANCES.

Figure 6. 10-Lead LFCSP Pin Configuration

Table 7. Pin Function Descriptions

Pin No	Mnemonic	Type <sup>1</sup>	Description
1	REF	AI	Reference Input Voltage. The REF range is from 0.5 V to VDD. It is referred to the GND pin. This pin should be decoupled closely to the pin with a 10 $\mu$ F capacitor.
2	VDD	P	Power Supply.
3	IN+	AI	Analog Input. It is referred to IN-. The voltage range, that is, the difference between IN+ and IN-, is 0 V to V <sub>REF</sub> .
4	IN-	AI	Analog Input Ground Sense. Connect to the analog ground plane or to a remote sense ground.
5	GND	P	Power Supply Ground.
6	CNV	DI	Convert Input. This input has multiple functions. On its leading edge, it initiates the conversions and selects the interface mode of the part, chain, or $\overline{CS}$ mode. In $\overline{CS}$ mode, it enables the SDO pin when low. In chain mode, the data should be read when CNV is high.
7	SDO	DO	Serial Data Output. The conversion result is output on this pin. It is synchronized to SCK.
8	SCK	DI	Serial Data Clock Input. When the part is selected, the conversion result is shifted out by this clock.
9	SDI	DI	Serial Data Input. This input provides multiple features. It selects the interface mode of the ADC as follows: Chain mode is selected if SDI is low during the CNV rising edge. In this mode, SDI is used as a data input to daisy chain the conversion results of two or more ADCs onto a single SDO line. The digital data level on SDI is output on SDO with a delay of 16 SCK cycles. $\overline{CS}$ mode is selected if SDI is high during the CNV rising edge. In this mode, either SDI or CNV can enable the serial output signals when low, and if SDI or CNV is low when the conversion is complete, the BUSY indicator feature is enabled.
10	VIO EPAD	P N/A	Input/Output Interface Digital Power. Nominally at the same supply as the host interface (1.8 V, 2.5 V, 3 V, or 5 V). Exposed Pad. Exposed pad connected to GND. This connection is not required to meet the electrical performances.

<sup>1</sup>AI = analog input, DI = digital input, DO = digital output, and P = power.

## TERMINOLOGY

### Integral Nonlinearity Error (INL)

INL refers to the deviation of each individual code from a line drawn from negative full scale through positive full scale. The point used as negative full scale occurs  $\frac{1}{2}$  LSB before the first code transition. Positive full scale is defined as a level  $1\frac{1}{2}$  LSB beyond the last code transition. The deviation is measured from the middle of each code to the true straight line (see Figure 26).

### Differential Nonlinearity Error (DNL)

In an ideal ADC, code transitions are 1 LSB apart. DNL is the maximum deviation from this ideal value. It is often specified in terms of resolution for which no missing codes are guaranteed.

### Offset Error

The first transition should occur at a level  $\frac{1}{2}$  LSB above analog ground (38.1  $\mu$ V for the 0 V to 5 V range). The offset error is the deviation of the actual transition from that point.

### Gain Error

The last transition (from 111 . . . 10 to 111 . . . 11) should occur for an analog voltage  $1\frac{1}{2}$  LSB below the nominal full scale (4.999886 V for the 0 V to 5 V range). The gain error is the deviation of the actual level of the last transition from the ideal level after the offset is adjusted out.

### Spurious-Free Dynamic Range (SFDR)

The difference, in decibels (dB), between the rms amplitude of the input signal and the peak spurious signal.

### Effective Number of Bits (ENOB)

ENOB is a measurement of the resolution with a sine wave input. It is related to SINAD by

$$ENOB = (SINAD_{dB} - 1.76)/6.02$$

and is expressed in bits.

### Total Harmonic Distortion (THD)

THD is the ratio of the rms sum of the first five harmonic components to the rms value of a full-scale input signal and is expressed in dB.

### Signal-to-Noise Ratio (SNR)

SNR is the ratio of the rms value of the actual input signal to the rms sum of all other spectral components below the Nyquist frequency, excluding harmonics and dc. The value for SNR is expressed in dB.

### Signal-to-(Noise + Distortion), SINAD

SINAD is the ratio of the rms value of the actual input signal to the rms sum of all other spectral components below the Nyquist frequency, including harmonics but excluding dc. The value for SINAD is expressed in dB.

### Aperture Delay

Aperture delay is a measure of the acquisition performance and is the time between the rising edge of the CNV input and when the input signal is held for a conversion.

### Transient Response

The time required for the ADC to accurately acquire its input after a full-scale step function is applied.

TYPICAL PERFORMANCE CHARACTERISTICS

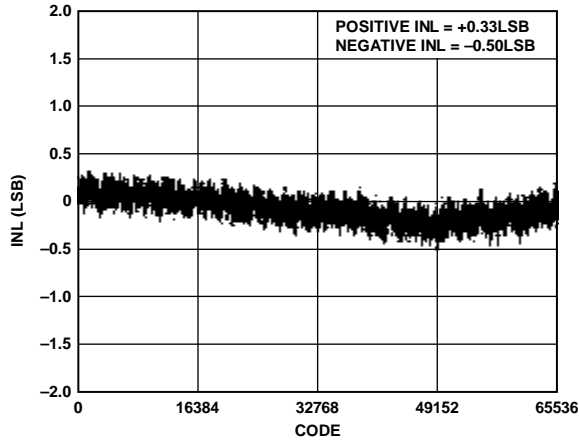

Figure 7. Integral Nonlinearity vs. Code

02988-047

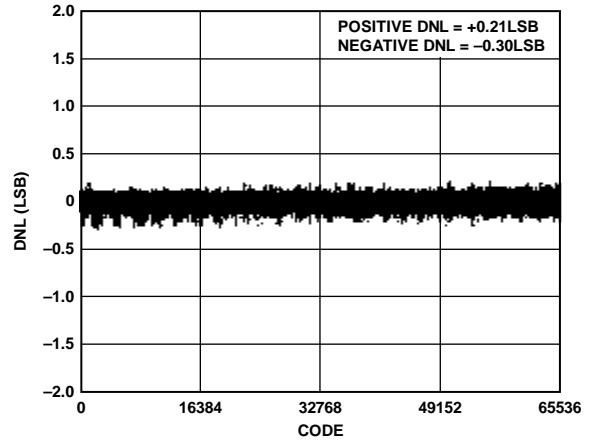

Figure 10. Differential Nonlinearity vs. Code

02988-008

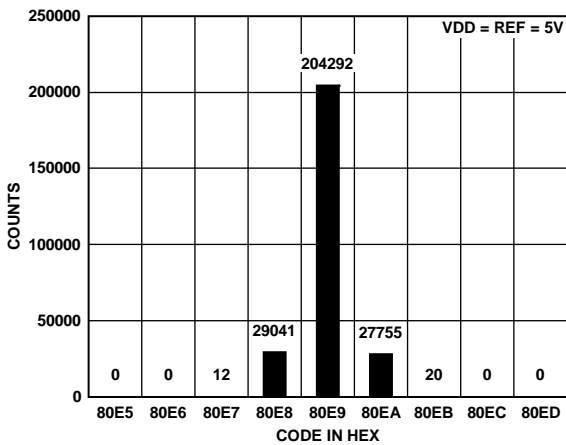

Figure 8. Histogram of a DC Input at the Code Center

02988-006

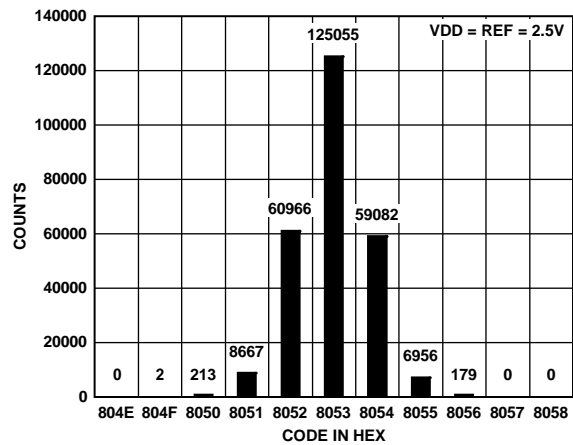

Figure 11. Histogram of a DC Input at the Code Center

02988-009

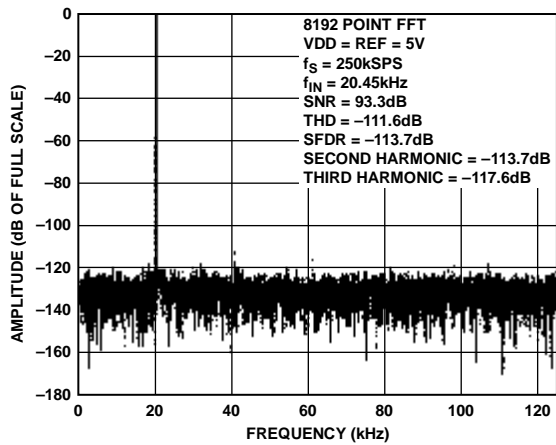

Figure 9. FFT Plot

02988-007

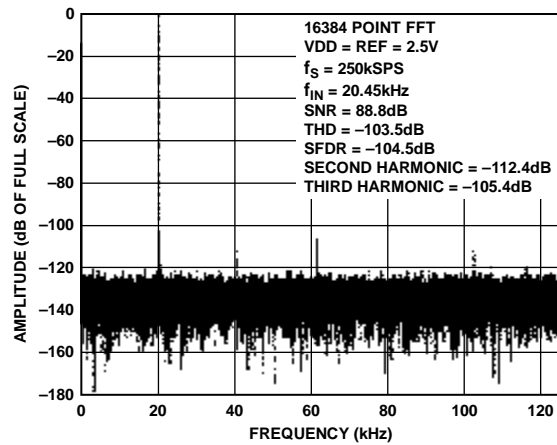

Figure 12. FFT Plot

02988-010

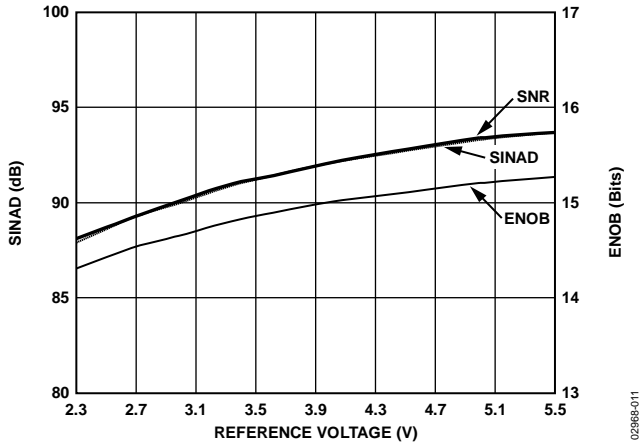

Figure 13. SNR, SINAD, and ENOB vs. Reference Voltage

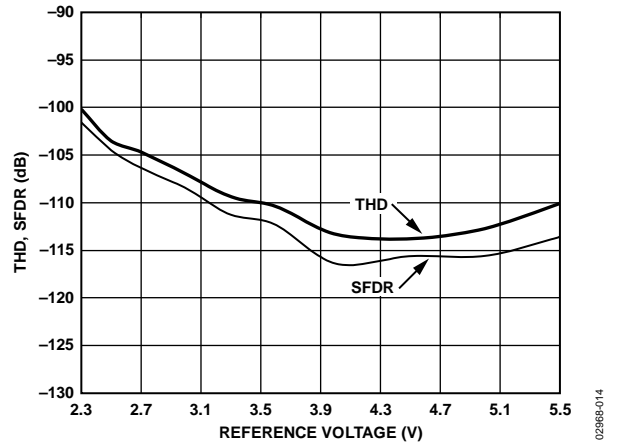

Figure 16. THD, SFDR vs. Reference Voltage

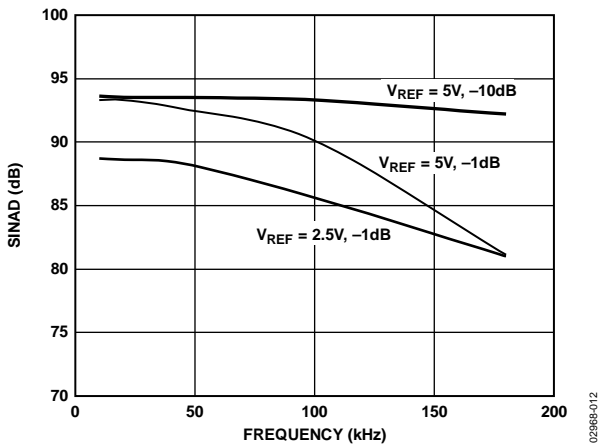

Figure 14. SINAD vs. Frequency

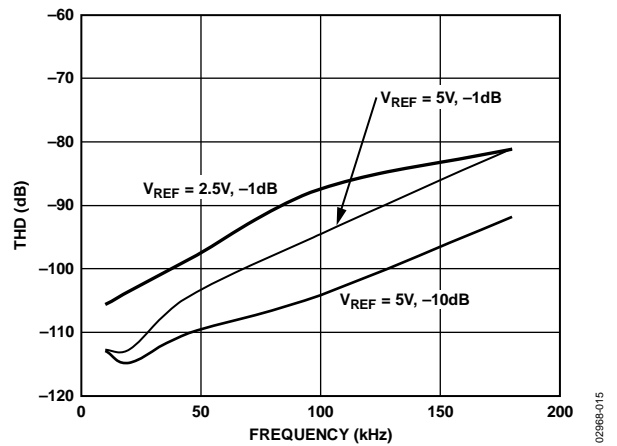

Figure 17. THD vs. Frequency

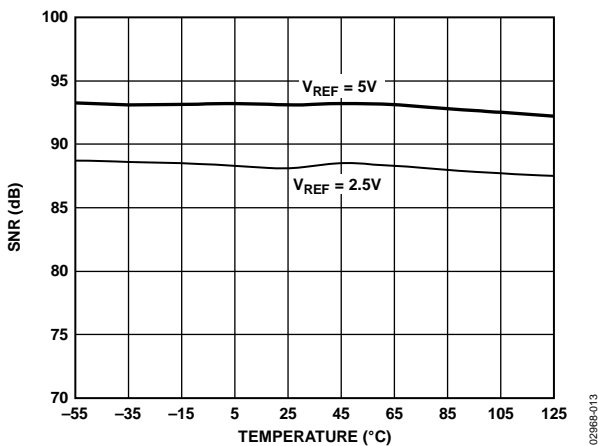

Figure 15. SNR vs. Temperature

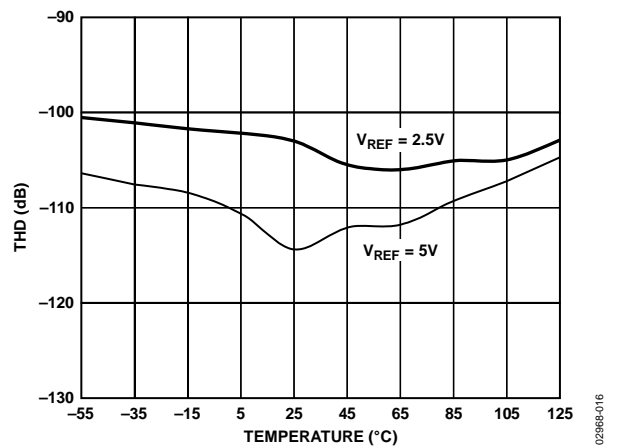

Figure 18. THD vs. Temperature

029868-011

029868-014

029868-012

029868-015

029868-013

029868-016

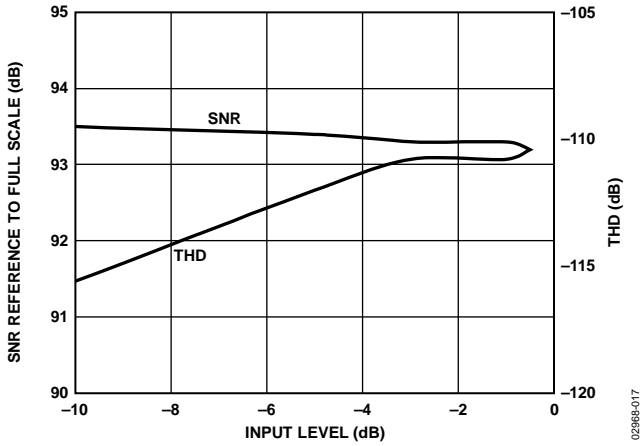

Figure 19. SNR and THD vs. Input Level

029868-017

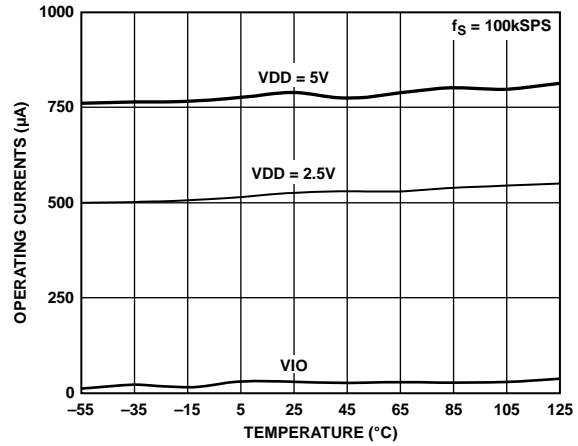

Figure 22. Operating Currents vs. Temperature

029868-020

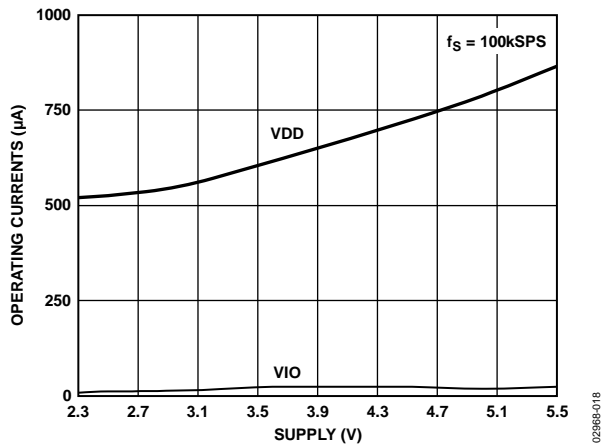

Figure 20. Operating Currents vs. Supply

029868-018

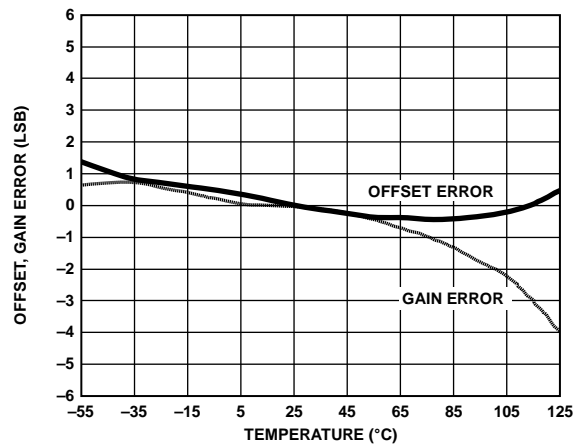

Figure 23. Offset and Gain Error vs. Temperature

029868-021

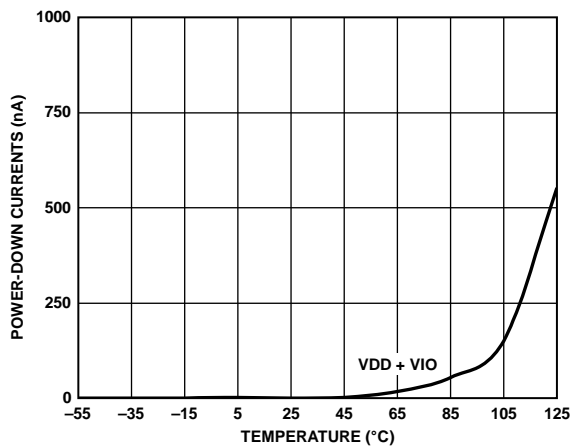

Figure 21. Power-Down Currents vs. Temperature

029868-019

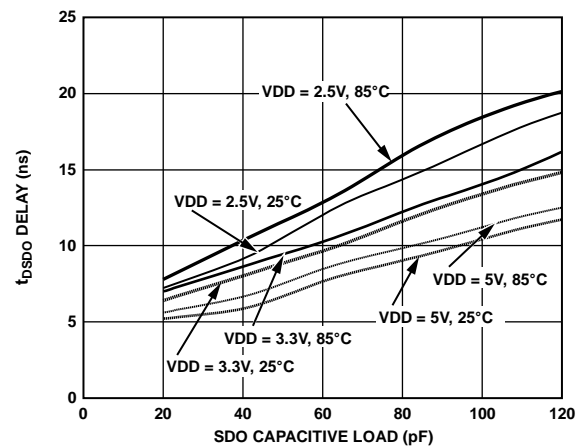

Figure 24.  $t_{psdc}$  Delay vs. Capacitance Load and Supply

029868-022

## THEORY OF OPERATION

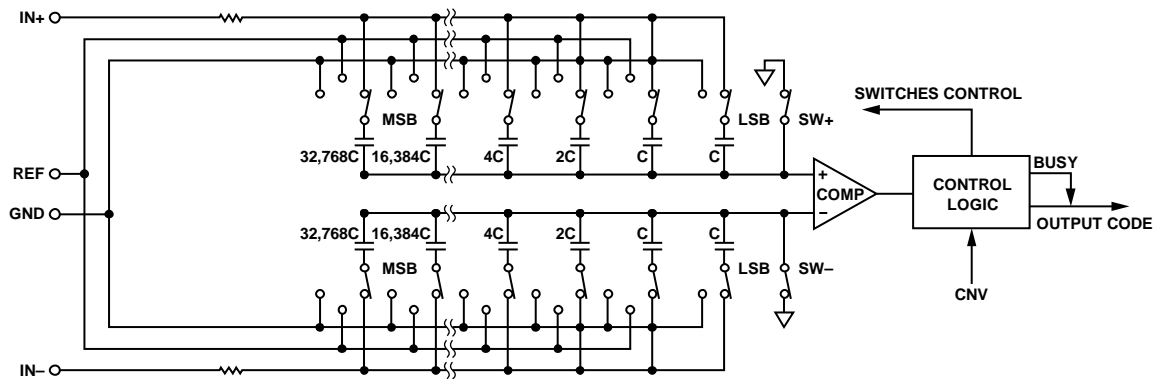

Figure 25. ADC Simplified Schematic

029868-023

### CIRCUIT INFORMATION

The [AD7685](#) is a fast, low power, single-supply, precise 16-bit ADC using a successive approximation architecture.

The [AD7685](#) is capable of converting 250,000 samples per second (250 kSPS) and powers down between conversions. When operating at 100 SPS, for example, it consumes typically 1.35  $\mu$ W with a 2.5 V supply, ideal for battery-powered applications.

The [AD7685](#) provides the user with on-chip, track-and-hold and does not exhibit any pipeline delay or latency, making it ideal for multiple multiplexed channel applications.

The [AD7685](#) is specified from 2.3 V to 5.5 V and can be interfaced to any 1.8 V to 5 V digital logic family. It is housed in a 10-lead MSOP or a tiny 10-lead LFCSP that combines space savings and allows flexible configurations.

It is pin-for-pin-compatible with the [AD7686](#), [AD7687](#), and [AD7688](#).

### CONVERTER OPERATION

The [AD7685](#) is a successive approximation ADC based on a charge redistribution DAC. Figure 25 shows the simplified schematic of the ADC. The capacitive DAC consists of two identical arrays of 16 binary weighted capacitors, which are connected to the two comparator inputs.

During the acquisition phase, terminals of the array tied to the comparator's input are connected to GND via SW+ and SW-. All independent switches are connected to the analog inputs. Therefore, the capacitor arrays are used as sampling capacitors and acquire the analog signal on the IN+ and IN- inputs. When the acquisition phase is complete and the CNV input goes high, a conversion phase is initiated. When the conversion phase begins, SW+ and SW- are opened first. The two capacitor arrays are then disconnected from the inputs and connected to the GND input. Therefore, the differential voltage between the inputs IN+ and IN- captured at the end of the acquisition phase is applied to the comparator inputs, causing the comparator to become unbalanced. By switching each element of the capacitor array between GND and REF, the comparator input varies by binary weighted voltage steps ( $V_{REF}/2$ ,  $V_{REF}/4$  . . .  $V_{REF}/65536$ ). The control logic toggles these switches, starting with the MSB, to bring the comparator back into a balanced condition. After the completion of this process, the part powers down and returns to the acquisition phase, and the control logic generates the ADC output code and a BUSY signal indicator.

Because the [AD7685](#) has an on-board conversion clock, the serial clock, SCK, is not required for the conversion process.

**Transfer Functions**

The ideal transfer characteristic for the AD7685 is shown in Figure 26 and Table 8.

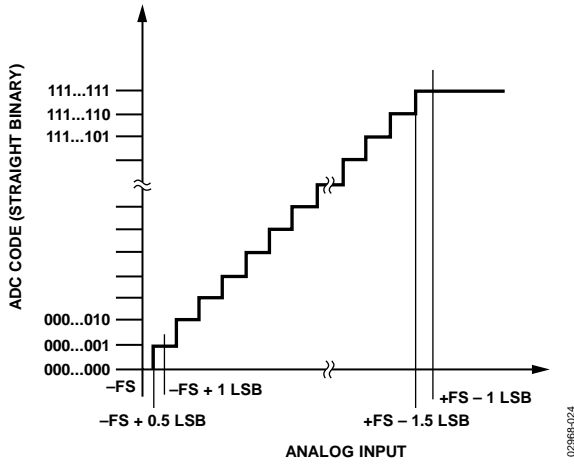
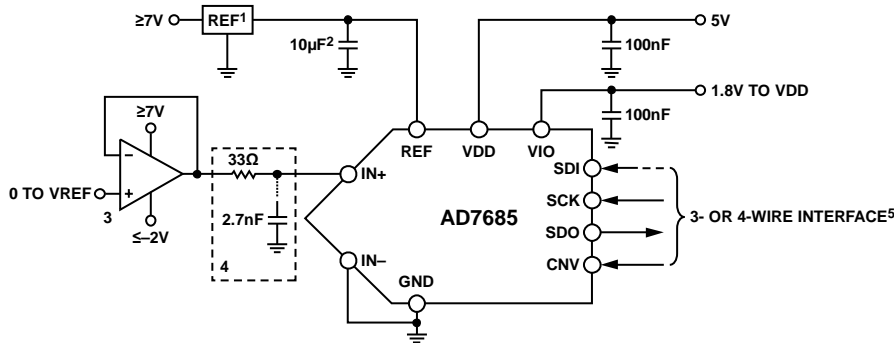

Figure 26. ADC Ideal Transfer Function

**TYPICAL CONNECTION DIAGRAM**

Figure 27 shows an example of the recommended connection diagram for the AD7685 when multiple supplies are available.



- NOTES**
1. SEE VOLTAGE REFERENCE INPUT SECTION FOR REFERENCE SELECTION.
  2.  $C_{REF}$  IS USUALLY A 10µF CERAMIC CAPACITOR (X5R).
  3. SEE DRIVER AMPLIFIER CHOICE SECTION.
  4. OPTIONAL FILTER. SEE ANALOG INPUT SECTION.
  5. SEE DIGITAL INTERFACE FOR MOST CONVENIENT INTERFACE MODE.

Figure 27. Typical Application Diagram with Multiple Supplies

**Table 8. Output Codes and Ideal Input Voltages**

Description	Analog Input $V_{REF} = 5V$	Digital Output Code Hexa
FSR – 1 LSB	4.999924 V	FFFF <sup>1</sup>
Midscale + 1 LSB	2.500076 V	8001
Midscale	2.5 V	8000
Midscale – 1 LSB	2.499924 V	7FFF
–FSR + 1 LSB	76.3 µV	0001
–FSR	0 V	0000 <sup>2</sup>

<sup>1</sup> This is also the code for an overranged analog input ( $V_{IN+} - V_{IN-}$  above  $V_{REF} - V_{GND}$ ).  
<sup>2</sup> This is also the code for an underranged analog input ( $V_{IN+} - V_{IN-}$  below  $V_{GND}$ ).

**ANALOG INPUTS**

Figure 28 shows an equivalent circuit of the input structure of the AD7685.

The two diodes, D1 and D2, provide ESD protection for the analog inputs IN+ and IN-. Care must be taken to ensure that the analog input signal never exceeds the supply rails by more than 0.3 V because this will cause these diodes to begin to forward-bias and start conducting current. These diodes can handle a forward-biased current of 130 mA maximum. For instance, these conditions could eventually occur when the input buffer's (U1) supplies are different from VDD. In such a case, an input buffer with a short-circuit current limitation can be used to protect the part.

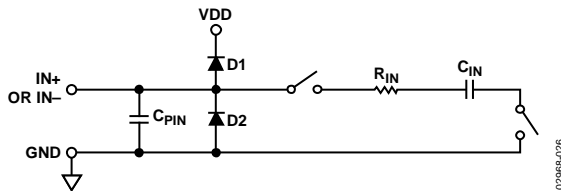

Figure 28. Equivalent Analog Input Circuit

This analog input structure allows the sampling of the differential signal between IN+ and IN-. By using this differential input, small signals common to both inputs are rejected, as shown in Figure 29, which represents the typical CMRR over frequency. For instance, by using IN- to sense a remote signal ground, ground potential differences between the sensor and the local ADC ground are eliminated.

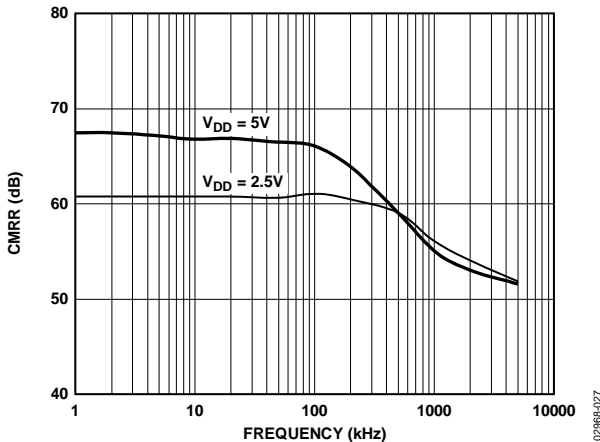

Figure 29. Analog Input CMRR vs. Frequency

During the acquisition phase, the impedance of the analog inputs (IN+ or IN-) can be modeled as a parallel combination of capacitor C<sub>PIN</sub> and the network formed by the series connection of R<sub>IN</sub> and C<sub>IN</sub>. C<sub>PIN</sub> is primarily the pin capacitance. R<sub>IN</sub> is typically 3 kΩ and is a lumped component made up of some serial resistors and the on resistance of the switches. C<sub>IN</sub> is typically 30 pF and is mainly the ADC sampling capacitor. During the conversion phase, where the switches are opened, the input impedance is limited to C<sub>PIN</sub>. R<sub>IN</sub> and C<sub>IN</sub> make a 1-pole, low-pass filter that reduces undesirable aliasing effects and limits the noise.

When the source impedance of the driving circuit is low, the AD7685 can be driven directly. Large source impedances significantly affect the ac performance, especially THD. The dc performances are less sensitive to the input impedance. The maximum source impedance depends on the amount of THD that can be tolerated. The THD degrades as a function of the source impedance and the maximum input frequency, as shown in Figure 30.

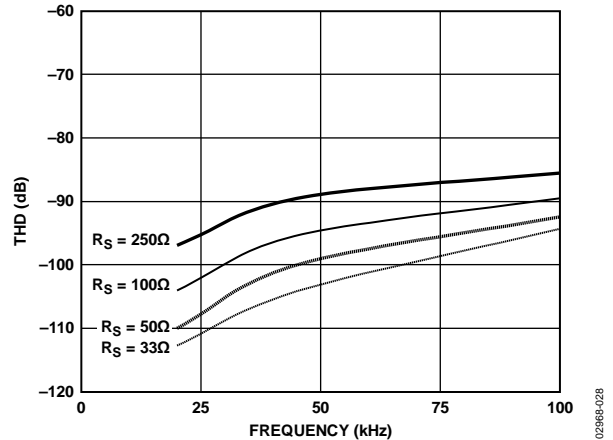

Figure 30. THD vs. Analog Input Frequency and Source Resistance

## DRIVER AMPLIFIER CHOICE

Although the AD7685 is easy to drive, the driver amplifier needs to meet the following requirements:

- The noise generated by the driver amplifier needs to be kept as low as possible to preserve the SNR and transition noise performance of the AD7685. Note that the AD7685 has a noise much lower than most of the other 16-bit ADCs and, therefore, can be driven by a noisier amplifier to meet a given system noise specification. The noise coming from the amplifier is filtered by the AD7685 analog input circuit low-pass filter made by  $R_{IN}$  and  $C_{IN}$  or by an external filter, if one is used. Because the typical noise of the AD7685 is 35  $\mu\text{V}$  rms, the SNR degradation due to the amplifier is

$$SNR_{LOSS} = 20 \log \left( \frac{35}{\sqrt{35^2 + \frac{\pi}{2} f_{-3dB} (Ne_N)^2}} \right)$$

where:

$f_{-3dB}$  is the input bandwidth in MHz of the AD7685 (2 MHz) or the cutoff frequency of the input filter, if one is used.

$N$  is the noise gain of the amplifier (for example, 1 in buffer configuration).

$e_N$  is the equivalent input noise voltage of the op amp, in  $n\text{V}/\sqrt{\text{Hz}}$ .

- For ac applications, the driver should have a THD performance commensurate with the AD7685. Figure 17 shows the AD7685s THD vs. frequency.
- For multichannel, multiplexed applications, the driver amplifier and the AD7685 analog input circuit must settle a full-scale step onto the capacitor array at a 16-bit level (0.0015%). In the amplifier's data sheet, settling at 0.1% to 0.01% is more commonly specified. This could differ significantly from the settling time at a 16-bit level and should be verified prior to driver selection.

**Table 9. Recommended Driver Amplifiers**

Amplifier	Typical Application
ADA4841-x	Very low noise and low power
AD8605, AD8615	5 V single-supply, low power
AD8655	5 V single-supply, low power
OP184	Low power, low noise, and low frequency
AD8021	Very low noise and high frequency
AD8022	Very low noise and high frequency
AD8519	Small, low power and low frequency
AD8031	High frequency and low power

## VOLTAGE REFERENCE INPUT

The AD7685 voltage reference input, REF, has a dynamic input impedance and should therefore be driven by a low impedance source with efficient decoupling between the REF and GND pins, as explained in the Layout section.

When REF is driven by a very low impedance source, for example, a reference buffer using the AD8031 or the AD8605, a 10  $\mu\text{F}$  (X5R, 0805 size) ceramic chip capacitor is appropriate for optimum performance.

If an unbuffered reference voltage is used, the decoupling value depends on the reference used. For instance, a 22  $\mu\text{F}$  (X5R, 1206 size) ceramic chip capacitor is appropriate for optimum performance using a low temperature drift ADR43x reference.

If desired, smaller reference decoupling capacitor values down to 2.2  $\mu\text{F}$  can be used with a minimal impact on performance, especially DNL.

## POWER SUPPLY

The AD7685 is specified over a wide operating range from 2.3 V to 5.5 V. It has, unlike other low voltage converters, a noise low enough to design a 16-bit resolution system with low supply and respectable performance. It uses two power supply pins: a core supply VDD and a digital input/output interface supply VIO. VIO allows direct interface with any logic between 1.8 V and VDD. To reduce the number of supplies needed, the VIO and VDD can be tied together. The AD7685 is independent of power supply sequencing between VIO and VDD. Additionally, it is very insensitive to power supply variations over a wide frequency range, as shown in Figure 31, which represents PSRR over frequency.

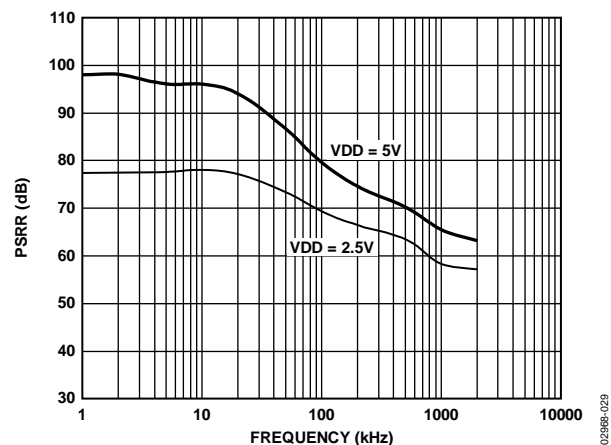

Figure 31. PSRR vs. Frequency

The AD7685 powers down automatically at the end of each conversion phase and, therefore, the power scales linearly with the sampling rate, as shown in Figure 32. This makes the part ideal for low sampling rate (even a few Hz) and low battery-powered applications.

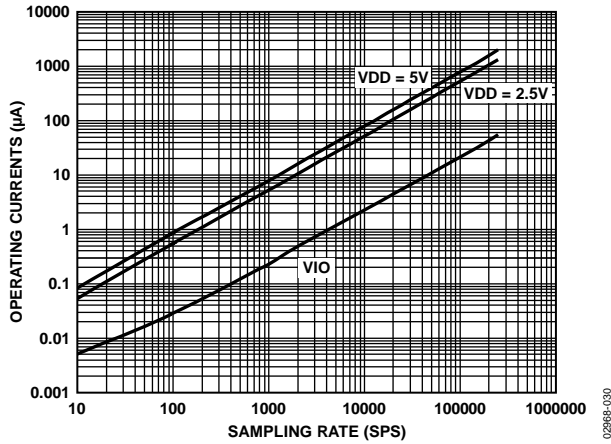
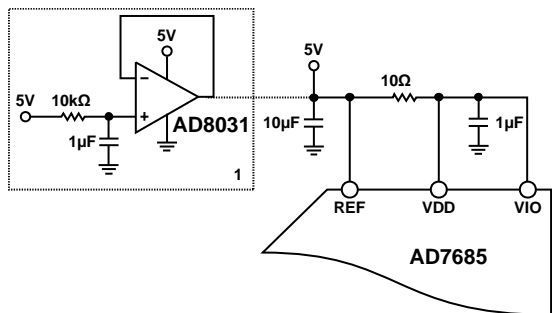

Figure 32. Operating Currents vs. Sampling Rate

## SUPPLYING THE ADC FROM THE REFERENCE

For simplified applications, the AD7685, with its low operating current, can be supplied directly using the reference circuit, as shown in Figure 33. The reference line can be driven by either:

- The system power supply directly.
- A reference voltage with enough current output capability, such as the ADR43x.
- A reference buffer, such as the AD8031, that can also filter the system power supply, as shown in Figure 33.



1OPTIONAL REFERENCE BUFFER AND FILTER.

Figure 33. Example of Application Circuit

## DIGITAL INTERFACE

Though the AD7685 has a reduced number of pins, it offers substantial flexibility in its serial interface modes.

The AD7685, when in  $\overline{CS}$  mode, is compatible with SPI, QSPI, digital hosts, and DSPs, for example, Blackfin® ADSP-BF53x or ADSP-219x. This interface can use either 3-wire or 4-wire. A 3-wire interface using the CNV, SCK, and SDO signals minimizes wiring connections, useful, for instance, in isolated applications. A 4-wire interface using the SDI, CNV, SCK, and SDO signals allows CNV, which initiates the conversions, to be independent of the readback timing (SDI). This is useful in low jitter sampling or simultaneous sampling applications.

The AD7685, when in chain mode, provides a daisy-chain feature using the SDI input for cascading multiple ADCs on a single data line similar to a shift register.

The mode in which the part operates depends on the SDI level when the CNV rising edge occurs. The  $\overline{CS}$  mode is selected if SDI is high and the chain mode is selected if SDI is low. The SDI hold time is such that when SDI and CNV are connected together, the chain mode is always selected.

In either the  $\overline{CS}$  mode or the chain mode, the AD7685 offers the flexibility to optionally force a start bit in front of the data bits. This start bit can be used as a BUSY signal indicator to interrupt the digital host and trigger the data reading. Otherwise, without a BUSY indicator, the user must time out the maximum conversion time prior to readback.

The BUSY indicator feature is enabled as follows:

- In the  $\overline{CS}$  mode, if CNV or SDI is low when the ADC conversion ends (see Figure 37 and Figure 41).
- In the chain mode, if SCK is high during the CNV rising edge (see Figure 45).

**$\overline{CS}$  MODE 3-WIRE, NO BUSY INDICATOR**

This mode is usually used when a single AD7685 is connected to an SPI-compatible digital host.

The connection diagram is shown in Figure 34, and the corresponding timing is given in Figure 35.

With SDI tied to VIO, a rising edge on CNV initiates a conversion, selects the  $\overline{CS}$  mode, and forces SDO to high impedance. Once a conversion is initiated, it will continue to completion irrespective of the state of CNV. For instance, it could be useful to bring CNV low to select other SPI devices, such as analog multiplexers, but CNV must be returned high before the minimum conversion time and held high until the maximum conversion time to avoid the generation of the BUSY signal indicator. When conversion is completed, the AD7685 enters the acquisition phase and powers down. When CNV goes low, the MSB is output onto SDO. The remaining data bits are then clocked by subsequent SCK falling edges. The data is

valid on both SCK edges. Although the rising edge can be used to capture the data, a digital host using the SCK falling edge will allow a faster reading rate provided it has an acceptable hold time. After the 16th SCK falling edge or when CNV goes high, whichever is earlier, SDO returns to high impedance.

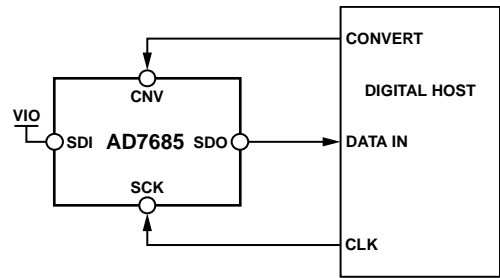

Figure 34.  $\overline{CS}$  Mode 3-Wire, No BUSY Indicator Connection Diagram (SDI High)

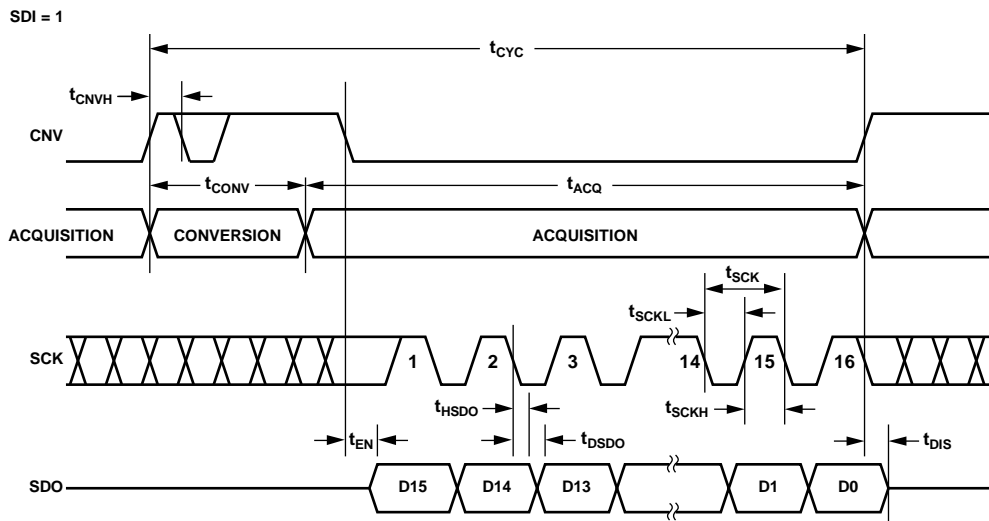

Figure 35.  $\overline{CS}$  Mode 3-Wire, No BUSY Indicator Serial Interface Timing (SDI High)

**$\overline{\text{CS}}$  MODE 3-WIRE WITH BUSY INDICATOR**

This mode is usually used when a single AD7685 is connected to an SPI-compatible digital host having an interrupt input.

The connection diagram is shown in Figure 36, and the corresponding timing is given in Figure 37.

With SDI tied to VIO, a rising edge on  $\overline{\text{CNV}}$  initiates a conversion, selects the  $\overline{\text{CS}}$  mode, and forces SDO to high impedance. SDO is maintained in high impedance until the completion of the conversion irrespective of the state of  $\overline{\text{CNV}}$ . Prior to the minimum conversion time,  $\overline{\text{CNV}}$  could be used to select other SPI devices, such as analog multiplexers, but  $\overline{\text{CNV}}$  must be returned low before the minimum conversion time and held low until the maximum conversion time to guarantee the generation of the BUSY signal indicator. When the conversion is complete, SDO goes from high impedance to low. With a pull-up on the SDO line, this transition can be used as an interrupt signal to initiate the data reading controlled by the digital host. The AD7685 then enters the acquisition phase and

powers down. The data bits are then clocked out, MSB first, by subsequent SCK falling edges. The data is valid on both SCK edges. Although the rising edge can be used to capture the data, a digital host using the SCK falling edge will allow a faster reading rate provided it has an acceptable hold time. After the optional 17th SCK falling edge, or when  $\overline{\text{CNV}}$  goes high, whichever is earlier, SDO returns to high impedance.

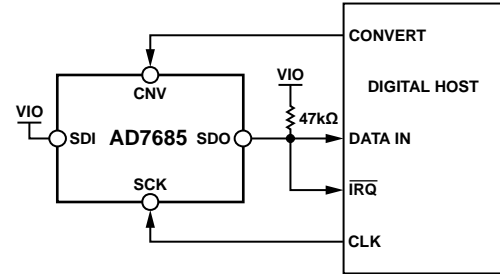

Figure 36.  $\overline{\text{CS}}$  Mode 3-Wire with BUSY Indicator Connection Diagram (SDI High)

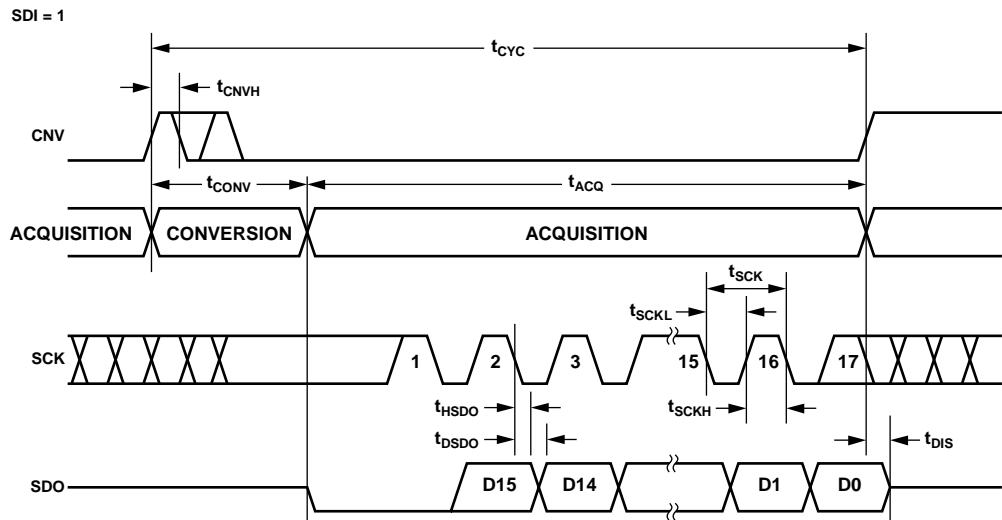

Figure 37.  $\overline{\text{CS}}$  Mode 3-Wire with BUSY Indicator Serial Interface Timing (SDI High)

**$\overline{CS}$  MODE 4-WIRE, NO BUSY INDICATOR**

This mode is usually used when multiple AD7685s are connected to an SPI-compatible digital host.

A connection diagram example using two AD7685s is shown in Figure 38, and the corresponding timing is given in Figure 39.

With  $\overline{SDI}$  high, a rising edge on  $\overline{CNV}$  initiates a conversion, selects the  $\overline{CS}$  mode, and forces  $\overline{SDO}$  to high impedance. In this mode,  $\overline{CNV}$  must be held high during the conversion phase and the subsequent data readback (if  $\overline{SDI}$  and  $\overline{CNV}$  are low,  $\overline{SDO}$  is driven low). Prior to the minimum conversion time,  $\overline{SDI}$  could be used to select other SPI devices, such as analog multiplexers, but  $\overline{SDI}$  must be returned high before the minimum conversion time and held high until the maximum conversion time to avoid the generation of the  $\overline{BUSY}$  signal indicator. When the

conversion is complete, the AD7685 enters the acquisition phase and powers down. Each ADC result can be read by bringing low its  $\overline{SDI}$  input, which consequently outputs the MSB onto  $\overline{SDO}$ . The remaining data bits are then clocked by subsequent  $\overline{SCK}$  falling edges. The data is valid on both  $\overline{SCK}$  edges. Although the rising edge can be used to capture the data, a digital host using the  $\overline{SCK}$  falling edge will allow a faster reading rate, provided it has an acceptable hold time. After the 16th  $\overline{SCK}$  falling edge, or when  $\overline{SDI}$  goes high, whichever is earlier,  $\overline{SDO}$  returns to high impedance and another AD7685 can be read.

If multiple AD7685s are selected at the same time, the  $\overline{SDO}$  output pin handles this contention without damage or induced latch-up. Meanwhile, it is recommended to keep this contention as short as possible to limit extra power dissipation.

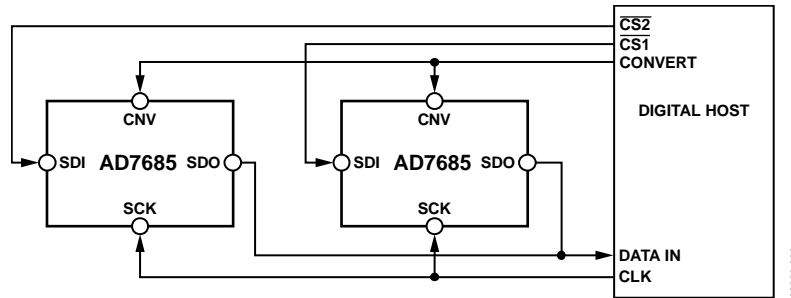

Figure 38.  $\overline{CS}$  Mode 4-Wire, No  $\overline{BUSY}$  Indicator Connection Diagram

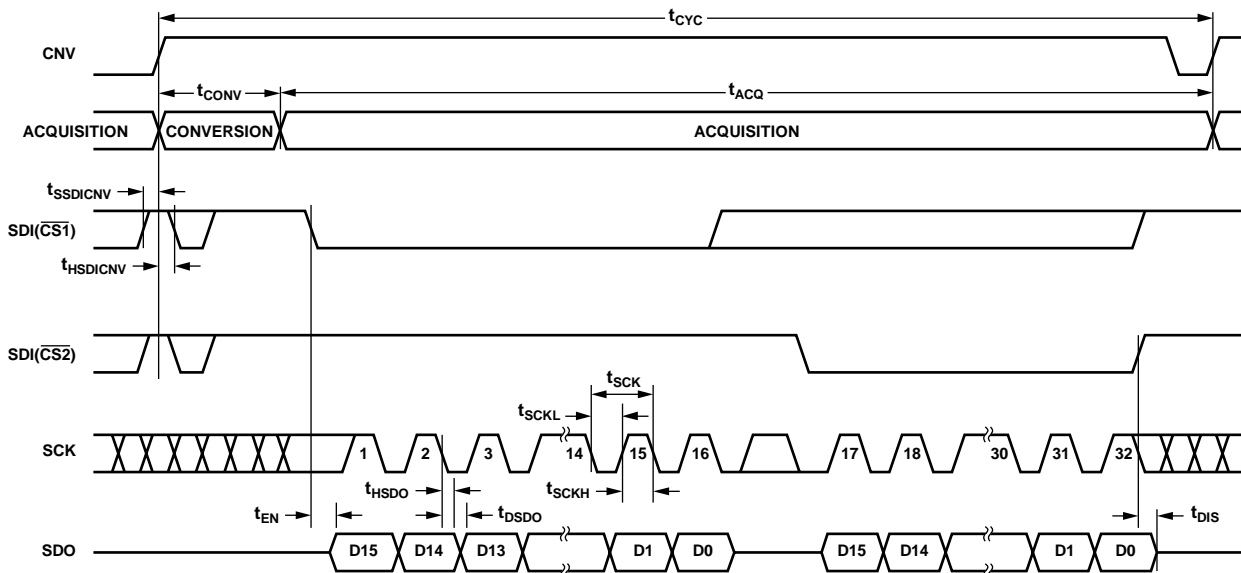

Figure 39.  $\overline{CS}$  Mode 4-Wire, No  $\overline{BUSY}$  Indicator Serial Interface Timing

**CS MODE 4-WIRE WITH BUSY INDICATOR**

This mode is usually used when a single AD7685 is connected to an SPI-compatible digital host, which has an interrupt input, and it is desired to keep CNV, which is used to sample the analog input, independent of the signal used to select the data reading. This requirement is particularly important in applications where low jitter on CNV is desired.

The connection diagram is shown in Figure 40, and the corresponding timing is given in Figure 41.

With SDI high, a rising edge on CNV initiates a conversion, selects the CS mode, and forces SDO to high impedance. In this mode, CNV must be held high during the conversion phase and the subsequent data readback (if SDI and CNV are low, SDO is driven low). Prior to the minimum conversion time, SDI could be used to select other SPI devices, such as analog multiplexers, but SDI must be returned low before the minimum conversion time and held low until the maximum conversion time to guarantee the generation of the BUSY signal indicator. When the conversion is complete, SDO goes from high impedance to low. With a pull-up on the SDO line, this transition can be used

as an interrupt signal to initiate the data readback controlled by the digital host. The AD7685 then enters the acquisition phase and powers down. The data bits are then clocked out, MSB first, by subsequent SCK falling edges. The data is valid on both SCK edges. Although the rising edge can be used to capture the data, a digital host using the SCK falling edge will allow a faster reading rate provided it has an acceptable hold time. After the optional 17th SCK falling edge, or SDI going high, whichever is earlier, the SDO returns to high impedance.

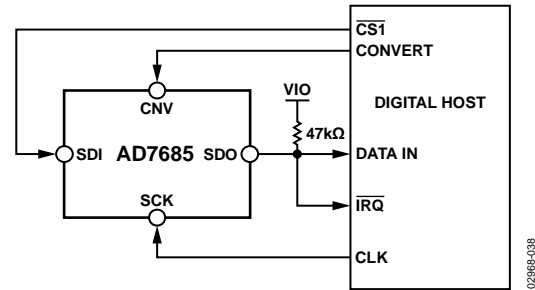

Figure 40. CS Mode 4-Wire with BUSY Indicator Connection Diagram

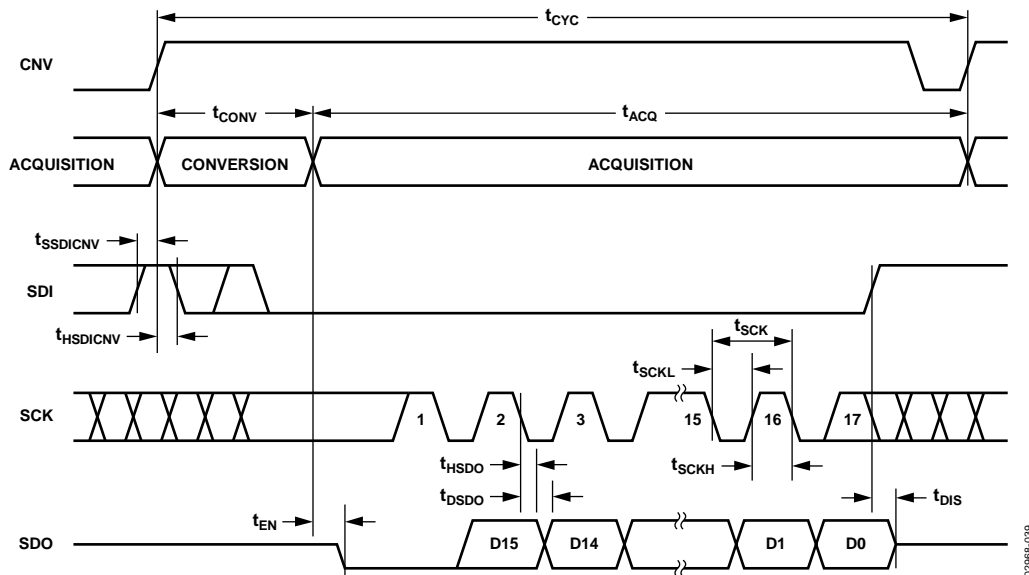

Figure 41. CS Mode 4-Wire with BUSY Indicator Serial Interface Timing

**CHAIN MODE, NO BUSY INDICATOR**

This mode can be used to daisy-chain multiple AD7685s on a 3-wire serial interface. This feature is useful for reducing component count and wiring connections, for example, in isolated multiconverter applications or for systems with a limited interfacing capacity. Data readback is analogous to clocking a shift register.

A connection diagram example using two AD7685s is shown in Figure 42, and the corresponding timing is given in Figure 43.

When SDI and CNV are low, SDO is driven low. With SCK low, a rising edge on CNV initiates a conversion and selects the chain mode. In this mode, CNV is held high during the conversion phase and the subsequent data readback. When the conversion is complete, the MSB is output onto SDO and the

AD7685 enters the acquisition phase and powers down. The remaining data bits stored in the internal shift register are then clocked by subsequent SCK falling edges. For each ADC, SDI feeds the input of the internal shift register and is clocked by the SCK falling edge. Each ADC in the chain outputs its data MSB first, and  $16 \times N$  clocks are required to readback the N ADCs. The data is valid on both SCK edges. Although the rising edge can be used to capture the data, a digital host using the SCK falling edge will allow a faster reading rate and, consequently, more AD7685s in the chain, provided the digital host has an acceptable hold time. The maximum conversion rate may be reduced due to the total readback time. For instance, with a 5 ns digital host setup time and 3 V interface, up to eight AD7685s running at a conversion rate of 220 kSPS can be daisy-chained on a 3-wire port.

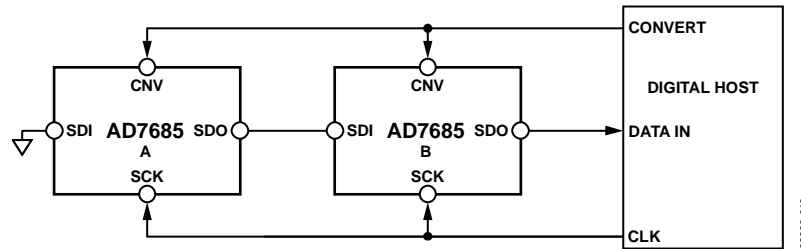

Figure 42. Chain Mode Connection Diagram

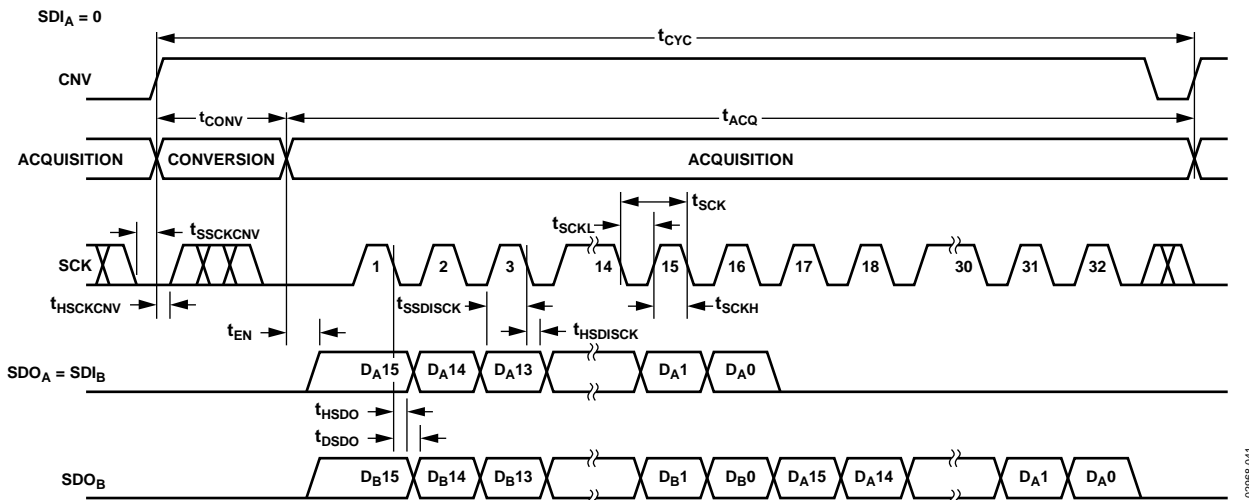

Figure 43. Chain Mode Serial Interface Timing

**CHAIN MODE WITH BUSY INDICATOR**

This mode can also be used to daisy chain multiple AD7685s on a 3-wire serial interface while providing a BUSY indicator. This feature is useful for reducing component count and wiring connections, for example, in isolated multiconverter applications or for systems with a limited interfacing capacity. Data readback is analogous to clocking a shift register.

A connection diagram example using three AD7685s is shown in Figure 44, and the corresponding timing is given in Figure 45.

When SDI and CNV are low, SDO is driven low. With SCK high, a rising edge on CNV initiates a conversion, selects the chain mode, and enables the BUSY indicator feature. In this mode, CNV is held high during the conversion phase and the subsequent data readback. When all ADCs in the chain have completed their conversions, the near-end ADC (ADC C in

Figure 44) SDO is driven high. This transition on SDO can be used as a BUSY indicator to trigger the data readback controlled by the digital host. The AD7685 then enters the acquisition phase and powers down. The data bits stored in the internal shift register are then clocked out, MSB first, by subsequent SCK falling edges. For each ADC, SDI feeds the input of the internal shift register and is clocked by the SCK falling edge. Each ADC in the chain outputs its data MSB first, and  $16 \times N + 1$  clocks are required to readback the N ADCs. Although the rising edge can be used to capture the data, a digital host also using the SCK falling edge allows a faster reading rate and, consequently, more AD7685s in the chain, provided the digital host has an acceptable hold time. For instance, with a 5 ns digital host setup time and 3 V interface, up to eight AD7685s running at a conversion rate of 220 kSPS can be daisy-chained to a single 3-wire port.

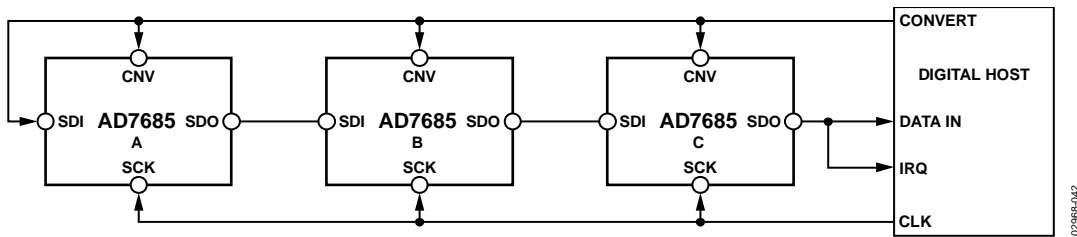

Figure 44. Chain Mode with BUSY Indicator Connection Diagram

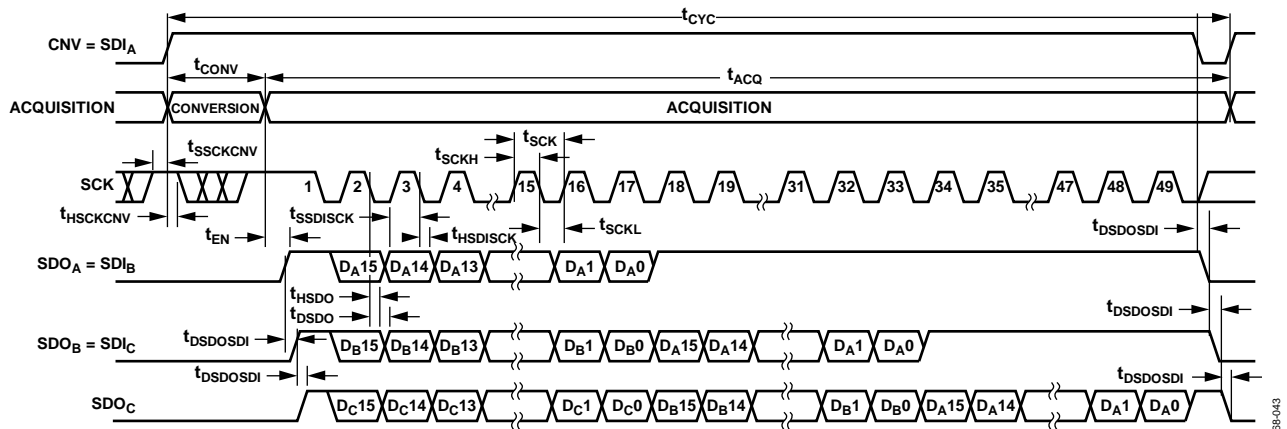

Figure 45. Chain Mode with BUSY Indicator Serial Interface Timing

## APPLICATION HINTS

### LAYOUT

The printed circuit board (PCB) that houses the [AD7685](#) should be designed so that the analog and digital sections are separated and confined to certain areas of the board. The pinout of the [AD7685](#) with all its analog signals on the left side and all its digital signals on the right side eases this task.

Avoid running digital lines under the device because these couple noise onto the die, unless a ground plane under the [AD7685](#) is used as a shield. Fast switching signals, such as CNV or clocks, should never run near analog signal paths. Crossover of digital and analog signals should be avoided.

At least one ground plane should be used. It could be common or split between the digital and analog section. In the latter case, the planes should be joined underneath the [AD7685](#).

The [AD7685](#) voltage reference input REF has a dynamic input impedance and should be decoupled with minimal parasitic inductances. This is done by placing the reference decoupling ceramic capacitor close to, and ideally right up against, the REF and GND pins and connected with wide, low impedance traces.

Finally, the power supplies VDD and VIO should be decoupled with ceramic capacitors, typically 100 nF, placed close to the [AD7685](#) and connected using short and wide traces to provide low impedance paths and to reduce the effect of glitches on the power supply lines.

An example layout following these rules is shown in Figure 46 and Figure 47.

### EVALUATING THE PERFORMANCE OF THE [AD7685](#)

Other recommended layouts for the [AD7685](#) are outlined in the documentation of the [EVAL-AD7685SDZ](#) evaluation board. The [EVAL-AD7685SDZ](#) evaluation board package includes a fully assembled and tested evaluation board, documentation, and software for controlling the board from a PC via the [EVAL-SDP-CB1Z](#).

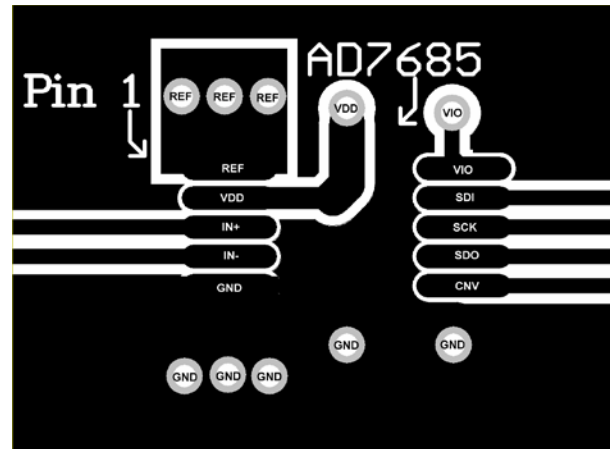

Figure 46. Example of Layout of the [AD7685](#) (Top Layer)

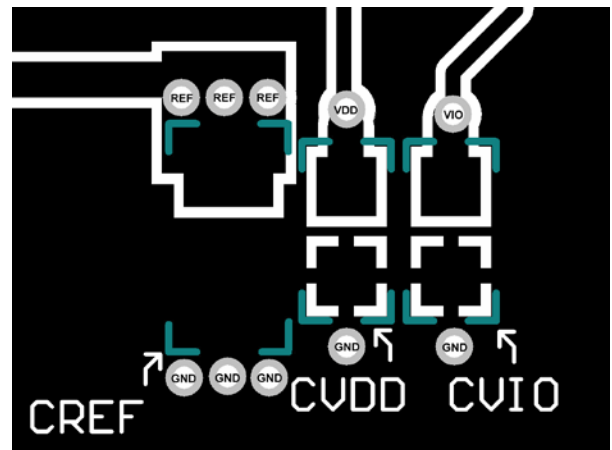

Figure 47. Example of Layout of the [AD7685](#) (Bottom Layer)

**TRUE 16-BIT ISOLATED APPLICATION EXAMPLE**

In applications where high accuracy and isolation are required, for example, power monitoring, motor control, and some medical equipment, the circuit given in Figure 48, using the AD7685 and the ADuM1402C digital isolator, provides a compact and high performance solution.

Multiple AD7685s are daisy-chained to reduce the number of signals to isolate. Note that the SCKOUT, which is a readback of the AD7685s clock, has a very short skew with the DATA signal. This skew is the channel-to-channel matching propagation delay of the digital isolator ( $t_{PSKCD}$ ). This allows running the serial interface at the maximum speed of the digital isolator (45 Mbps for the ADuM1402C), which would have been otherwise limited by the cascade of the propagation delays of the digital isolator.

The complete analog chain runs on a 5 V single supply using the ADR391 low dropout reference voltage and the rail-to-rail CMOS AD8618 amplifier while offering true bipolar input range.

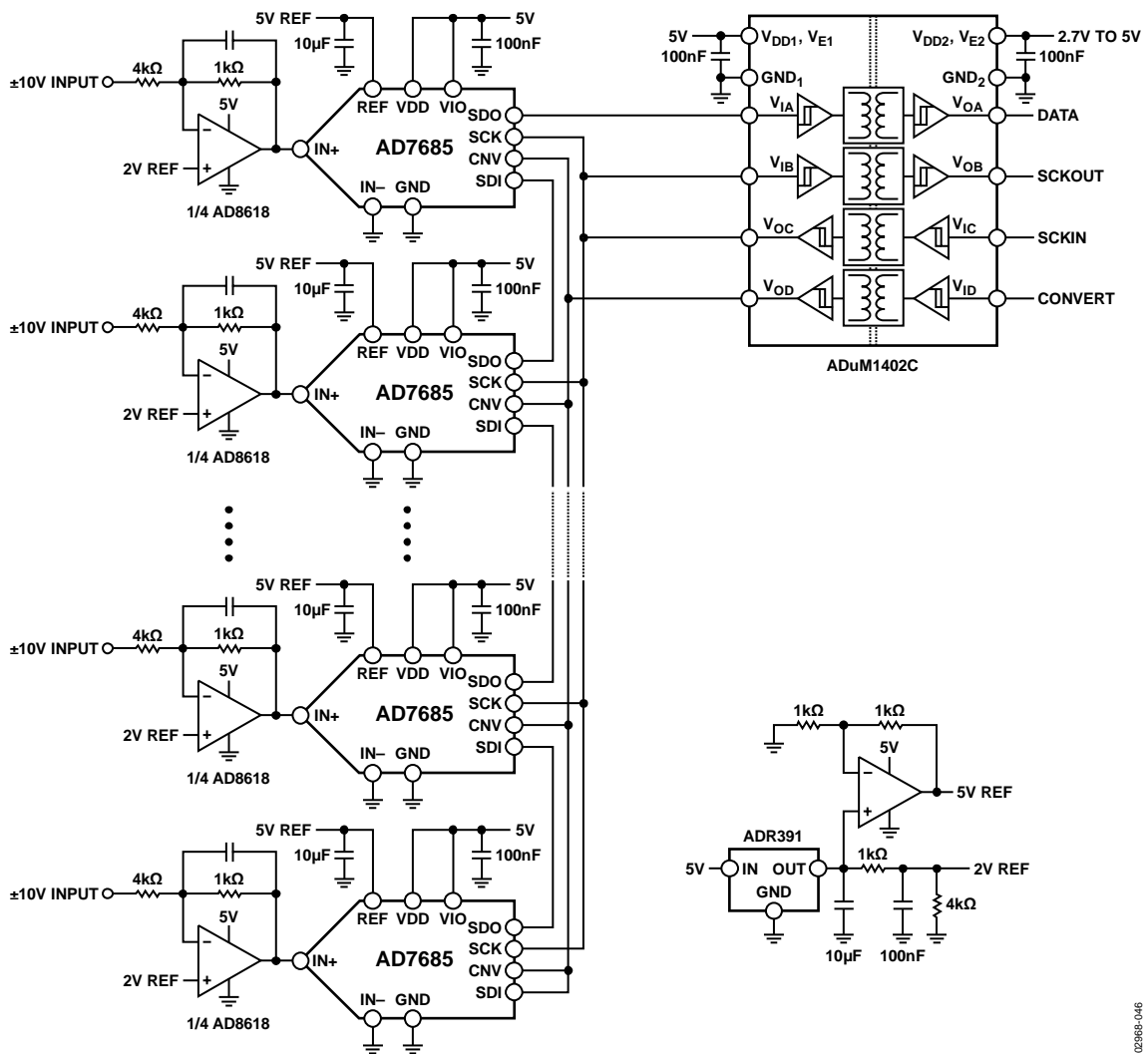
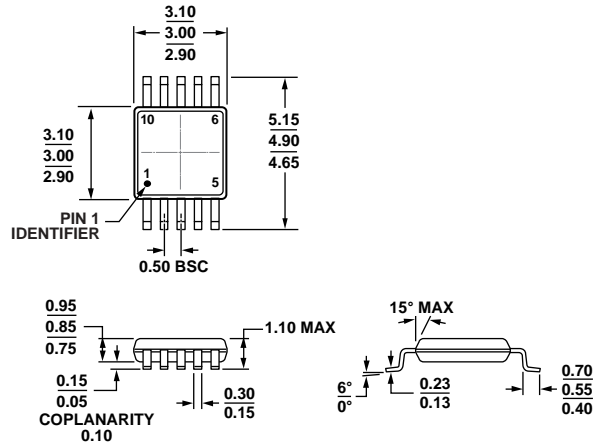

Figure 48. A True 16-Bit Isolated Simultaneous Sampling Acquisition System

02988-046

OUTLINE DIMENSIONS



COMPLIANT TO JEDEC STANDARDS MO-187-BA  
 Figure 49.10-Lead Micro Small Outline Package [MSOP]  
 (RM-10)  
 Dimensions shown in millimeters

081709-A

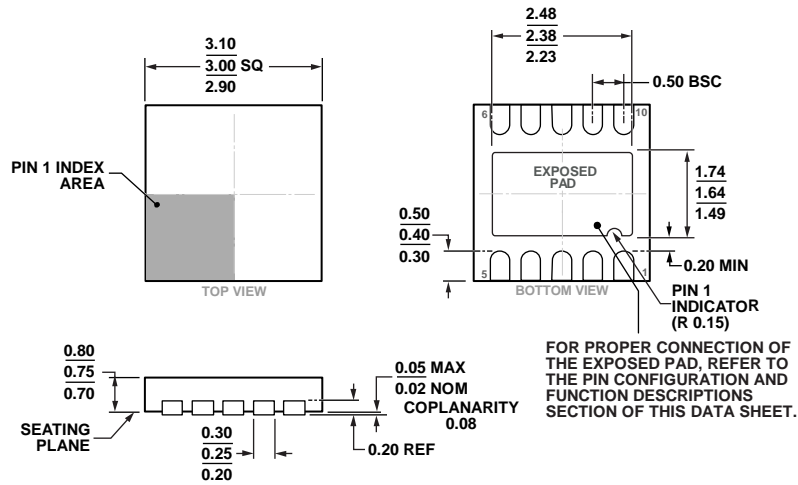

Figure 50. 10-Lead Lead Frame Chip Scale Package [LF CSP\_WD]  
 3 mm x 3 mm Body, Very Very Thin, Dual Lead  
 (CP-10-9)  
 Dimensions shown in millimeters

02-05-2013-C

## ORDERING GUIDE

Model <sup>1,2,3</sup>	Integral Nonlinearity	No Missing Code	Temperature Range	Package Description	Package Option	Branding	Ordering Quantity
AD7685ACPZRL	±6 LSB max	15 Bits	−40°C to +85°C	10-Lead LFCSP_WD	CP-10-9	C4H	Reel, 5,000
AD7685ACPZRL7	±6 LSB max	15 Bits	−40°C to +85°C	10-Lead LFCSP_WD	CP-10-9	C4H	Reel, 1,500
AD7685ARMZ	±6 LSB max	15 Bits	−40°C to +85°C	10-Lead MSOP	RM-10	C4H	Tube, 50
AD7685ARMZRL7	±6 LSB max	15 Bits	−40°C to +85°C	10-Lead MSOP	RM-10	C4H	Reel, 1,000
AD7685BCPZRL	±3 LSB max	16 Bits	−40°C to +85°C	10-Lead LFCSP_WD	CP-10-9	C3D	Reel, 5,000
AD7685BCPZRL7	±3 LSB max	16 Bits	−40°C to +85°C	10-Lead LFCSP_WD	CP-10-9	C3D	Reel, 1,500
AD7685BRMZ	±3 LSB max	16 Bits	−40°C to +85°C	10-Lead MSOP	RM-10	C3D	Tube, 50
AD7685BRMZRL7	±3 LSB max	16 Bits	−40°C to +85°C	10-Lead MSOP	RM-10	C3D	Reel, 1,000
AD7685CCPZRL	±2 LSB max	16 Bits	−40°C to +85°C	10-Lead LFCSP_WD	CP-10-9	C4J	Reel, 5,000
AD7685CCPZRL7	±2 LSB max	16 Bits	−40°C to +85°C	10-Lead LFCSP_WD	CP-10-9	C4J	Reel, 1,500
AD7685CRMZ	±2 LSB max	16 Bits	−40°C to +85°C	10-Lead MSOP	RM-10	C4J	Tube, 50
AD7685CRMZRL7	±2 LSB max	16 Bits	−40°C to +85°C	10-Lead MSOP	RM-10	C4J	Reel, 1,000
EVAL-AD7685SDZ				Evaluation Board			
EVAL-SDP-CB1Z				Controller Board			

<sup>1</sup> Z = RoHS Compliant Part.

<sup>2</sup> The [EVAL-AD7685SDZ](#) can be used as a standalone evaluation board or in conjunction with the [EVAL-SDP-CB1Z](#) for evaluation and/or demonstration purposes.

<sup>3</sup> The [EVAL-SDP-CB1Z](#) allows a PC to control and communicate with all Analog Devices, Inc. evaluation boards ending in the SDZ designator.

**NOTES**

## Looking for pricing, stock, or lifecycle information?

Click below to explore more details on WIN SOURCE:

 [View AD7685CRMZRL7 on WIN SOURCE](#)

 [Analog Devices Inc. Information](#)

## Optimize Your Supply Chain with WIN SOURCE Solutions

-  Global Sourcing Solution
-  Obsolete Management
-  Cost Control Management
-  Shortage Management
-  Alternative Solution
-  Excess Inventory Management