



THE DATASHEET OF MAX759CWE+T



EVALUATION KIT
AVAILABLE**MAXIM****-5V, -12V, -15V, and Adjustable
Inverting Current-Mode PWM Regulators****General Description**

The MAX736/MAX737/MAX739/MAX759 are CMOS, inverting, switch-mode regulators with an internal power MOSFET. Guaranteed output power for the MAX739 is 1.25W when powered from a +4.5V input, and 1.5W when powered from +6V. Quiescent supply current for the MAX739 is typically 1.7mA, and a shutdown mode reduces this to 1 μ A. These power-conserving features, along with high efficiency and an application circuit that lends itself to miniaturization, make these parts excel in a broad range of on-card and portable equipment applications.

The MAX736/MAX737/MAX739 have fixed outputs of -12V, -15V, and -5V respectively. The MAX759 is adjustable from 0V to -15V. Output voltages beyond -15V require a transformer.

These inverting DC-DC converters employ a high-performance, current-mode, pulse-width modulation (PWM) control scheme to provide tight output voltage regulation and low noise. The fixed-frequency oscillator is factory-trimmed to 165kHz, allowing easy noise filtering. The devices are production tested in an actual application circuit, and output accuracy is guaranteed at $\pm 5\%$ over all specified conditions of line, load, and temperature.

The input voltage range is +4V to +15V. For similar devices with smaller packages and an input voltage range of +4V to +11V, refer to the MAX735/MAX755 data sheet.

Applications

Low-Noise Analog Signal Processing Circuits
LCD Bias Supplies
Power Supplies for ECL
Board-Level DC-DC Conversion
Battery-Powered Equipment
Computer Peripherals

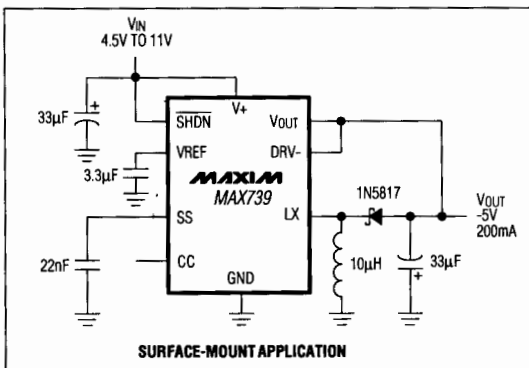
Typical Operating Circuit**Features**

- ◆ Pre-Set -5V, -12V, -15V or Adjustable Outputs
- ◆ Convert Positive Voltages to Negative
- ◆ 1.25W Guaranteed Output Power
- ◆ 83% Typical Efficiency
- ◆ 1.7mA Quiescent Current (MAX739)
- ◆ 1 μ A Shutdown Mode (MAX739)
- ◆ +4V to +15V Input Voltage Range
- ◆ 165kHz Current-Mode PWM – Low Noise and Jitter
- ◆ Undervoltage Lockout and Soft-Start Protection

Ordering Information

PART	TEMP. RANGE	PIN-PACKAGE
MAX736CPD	0°C to +70°C	14 Plastic DIP
MAX736CWE	0°C to +70°C	16 Wide SO
MAX736C/D	0°C to +70°C	Dice*
MAX736EPD	-40°C to +85°C	14 Plastic DIP
MAX736EWE	-40°C to +85°C	16 Wide SO
MAX736MJD	-55°C to +125°C	14 CERDIP**
MAX737CPD	0°C to +70°C	14 Plastic DIP
MAX737CWE	0°C to +70°C	16 Wide SO
MAX737C/D	0°C to +70°C	Dice*
MAX737EPD	-40°C to +85°C	14 Plastic DIP
MAX737EWE	-40°C to +85°C	16 Wide SO
MAX737MJD	-55°C to +125°C	14 CERDIP**

Ordering Information continued on last page of data sheet.

* Contact factory for dice specifications.

**Contact factory for availability and processing to MIL-STD-883.

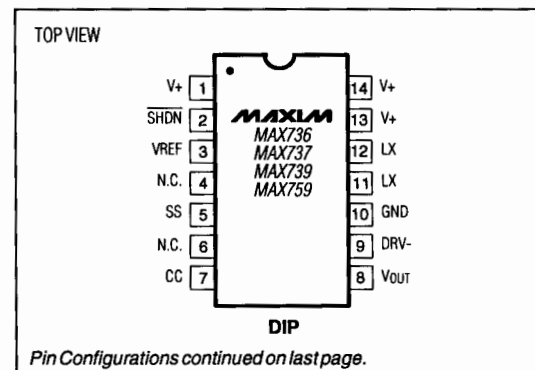
Pin Configurations

MAX736/MAX737/MAX739/MAX759

MAXIM

Maxim Integrated Products 3-177

Call toll free 1-800-998-8800 for free samples or literature.

-5V, -12V, -15V, and Adjustable Inverting Current-Mode PWM Regulators

ABSOLUTE MAXIMUM RATINGS

Supply Voltage (V+ to GND) (Note 1)	
MAX739/MAX759	15.5V, -0.3V
MAX736	9.5V, -0.3V
MAX737	6.5V, -0.3V
Maximum Input/Output Differential	
MAX736/MAX737	22V
MAX739/MAX759 (Non-Bootstrapped)	22V
MAX739/MAX759 (Bootstrapped)	17V
Negative Drive Voltage (DRV- to V+)	-17V, +0.3V
Switch Voltage (LX to V+)	-22.5V, +0.3V
Feedback Voltage (VOUT to GND)	±50V
Auxiliary Input Voltages	
(SS, CC, SHDN to GND)	-0.3V to (V+ + 0.3V)
Peak Switch Current (ILX)	2.5A
Reference Current (IvREF)	2.5mA

Continuous Power Dissipation (TA = +70°C)	
14-Pin Plastic DIP (derate 10.0mW/°C above +70°C)	800mW
16-Pin Wide SO (derate 9.52mW/°C above +70°C)	762mW
14-Pin CERDIP (derate 9.09mW/°C above +70°C)	727mW
Operating Temperature Ranges:	
MAX73_ /MAX759C_	0°C to +70°C
MAX73_ /MAX759E_	-40°C to +85°C
MAX73_ /MAX759MJD	-55°C to +125°C
Junction Temperatures:	
MAX73_ /MAX759E/C_	+150°C
MAX73_ /MAX759MJD	+175°C
Storage Temperature Range	-65°C to +160°C
Lead Temperature (soldering, 10sec)	+300°C

Note 1: Output voltages beyond -5V or bootstrapped operation reduce the allowable supply voltage. See Maximum Input/Output Differential specifications.

Stresses beyond those listed under "Absolute Maximum Ratings" may cause permanent damage to the device. These are stress ratings only, and functional operation of the device at these or any other conditions beyond those indicated in the operational sections of the specifications is not implied. Exposure to absolute maximum rating conditions for extended periods may affect device reliability.

ELECTRICAL CHARACTERISTICS

Bootstrapped Mode (Circuit of Figure 1, V+ = 5V, ILOAD = 0mA, DRV- = VOUT (-5V) (MAX739/MAX759), TA = TMIN to TMAX, unless otherwise noted.)

PARAMETER	CONDITIONS	MIN	TYP	MAX	UNITS
Input Voltage Range	DRV- ≥ -7V	MAX736	4.0	8.6	V
	DRV- ≥ -10V	MAX737	4.0	5.5	
	DRV- ≥ -5.25V	MAX739/MAX759	4.0	11.0	
Output Voltage	V+ = 4.5V to 8.6V, ILOAD = 0mA to 100mA	MAX736	-11.40	-12.60	V
	V+ = 6V to 8.6V, ILOAD = 0mA to 125mA		-11.40	-12.60	
	V+ = 4.5V to 5.5V, ILOAD = 0mA to 100mA	MAX737	-14.25	-15.75	
	V+ = 4.5V to 11V, ILOAD = 0mA to 250mA	MAX739 MAX759 (Notes 2, 3)	-4.750 -4.775	-5.250 -5.225	
Output Current	V+ = 4.5V to 8.6V	MAX736	100	140	mA
	V+ = 6V to 8.6V		125	150	
	V+ = 4.5V to 5.5V	MAX737	100	110	
	V+ = 4.5V to 11V TA = -40°C to +85°C	MAX739/MAX759 (Note 2)	250	300	
	V+ = 4.5V to 11V TA = -55°C to +125°C		200	250	
	V+ = 6V to 11V		300	500	
Supply Current		MAX736	4.2	6.0	mA
		MAX737	6.1	9.5	
		MAX739	1.7	3.5	
		MAX759	2.2	4.0	

-5V, -12V, -15V, and Adjustable Inverting Current-Mode PWM Regulators

MAX736/MAX737/MAX739/MAX759

ELECTRICAL CHARACTERISTICS (continued)

Bootstrapped Mode (Circuit of Figure 1, $V_+ = 5V$, $I_{LOAD} = 0mA$, $DRV^- = V_{OUT} (-5V)$ (MAX739/MAX759), $T_A = T_{MIN}$ to T_{MAX} , unless otherwise noted.)

PARAMETER	CONDITIONS	MIN	TYP	MAX	UNITS
Standby Current	$V_{SHDN} = 0V$ (Note 4)		1.0	100.0	μA
SHDN Logic High Voltage				$V_+ - 0.5$	V
SHDN Logic Low Voltage		0.25			V
SHDN Input Current			0.1	1.0	μA
LX Leakage Current			10		μA
Undervoltage Lockout	Measured at V_+		3.7	4.0	V
Reference Voltage	(Note 3)	1.16	1.23	1.30	V
Reference Drift			50		ppm/ $^{\circ}C$
Compensation-Pin Impedance			6		$k\Omega$
Oscillator Frequency	MAX736/MAX739	145	185	220	kHz
	MAX737/MAX759	145	185	220	

ELECTRICAL CHARACTERISTICS

Non-Bootstrapped Mode (Circuit of Figure 1, $T_A = T_{MIN}$ to T_{MAX} , unless otherwise noted.)

PARAMETER	CONDITIONS	MIN	TYP	MAX	UNITS	
Input Voltage Range	MAX736	4.0		8.6	V	
	MAX737	4.0		5.5		
	MAX739/MAX759	4.0		15.0		
Output Voltage, No Load (Note 2)	$V_+ = 4V$ to 8.6V	MAX736	-11.40	-12.60	V	
	$V_+ = 4V$ to 5.5V	MAX737	-14.25	-15.75		
	$V_+ = 4V$ to 15V	MAX739	-4.750	-5.250		
		MAX759 (Note 2)	-4.775	-5.225		
Output Current (Note 5)	$V_+ = 5V$	MAX736		70	mA	
		MAX737		50		
		MAX739/MAX759		250		
Supply Current, No Load	$V_+ = 5V$	MAX736/MAX739	1.6	3.0	mA	
		MAX737		2.5		4.5
		MAX759		2.1		4.0

Note 2: MAX759 output voltage tests are performed using an external resistor divider to set the output voltage to -5V (see Figure 5, $R_3 = 15k\Omega$, $R_4 = 3.69k\Omega$).

Note 3: Output voltage tolerance is $\pm 4.5\%$ plus external feedback resistor tolerances for the MAX759.

Note 4: The standby supply-current specification is set at $100\mu A$ due to test method limitations rather than actual device performance. The two-sigma distribution of standby supply current is less than $10\mu A$ (over temperature).

Note 5: $10\mu H$ inductor used with the MAX736/MAX737. $18\mu H$ inductor used with the MAX739/MAX759.

-5V, -12V, -15V, and Adjustable Inverting Current-Mode PWM Regulators

Typical Operating Characteristics

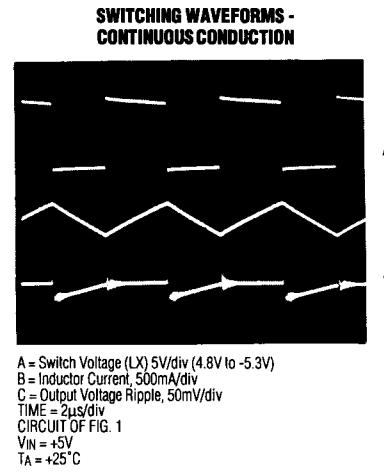
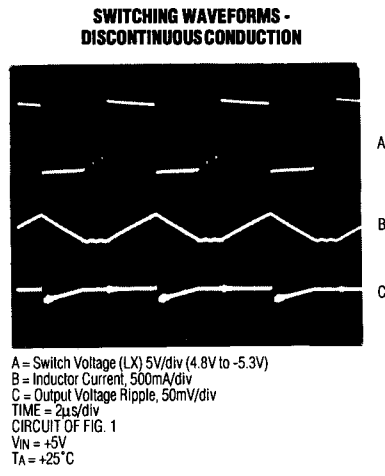
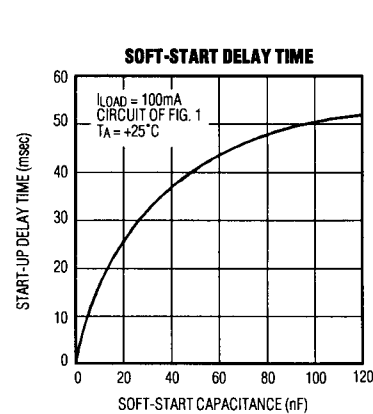
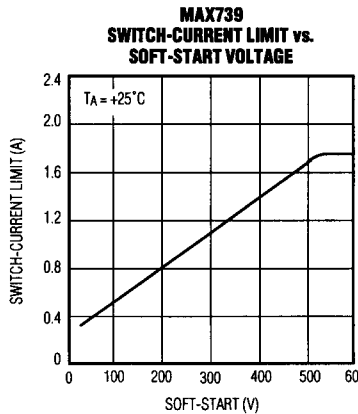
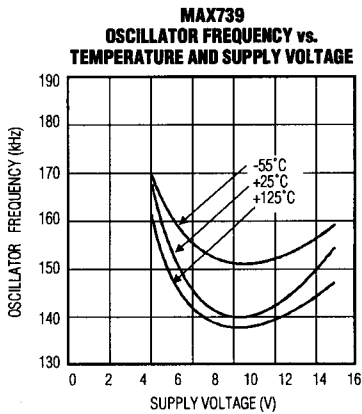
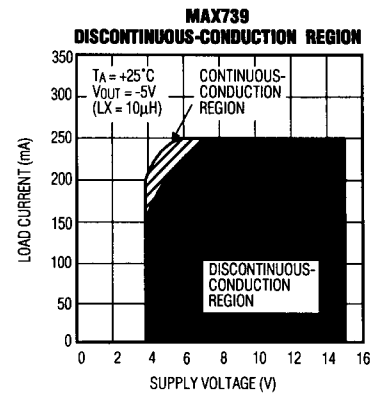
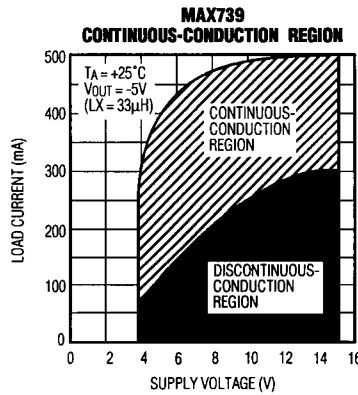
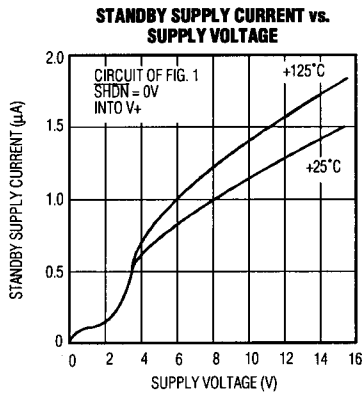

-5V, -12V, -15V, and Adjustable Inverting Current-Mode PWM Regulators

Typical Operating Characteristics (continued)

MAX736/MAX737/MAX739/MAX759

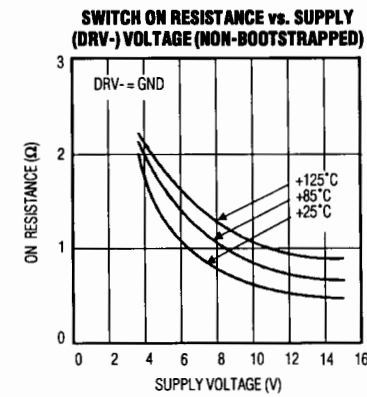
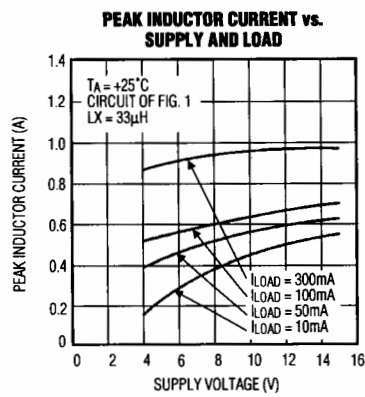
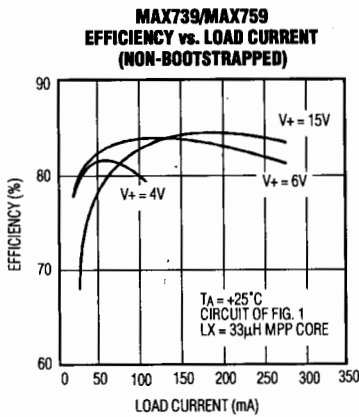
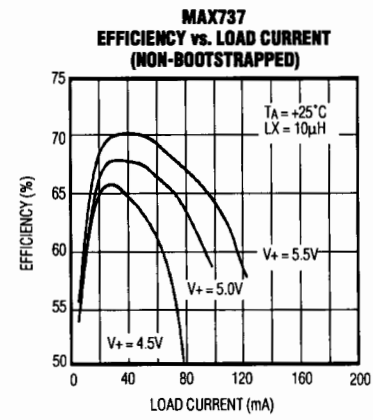
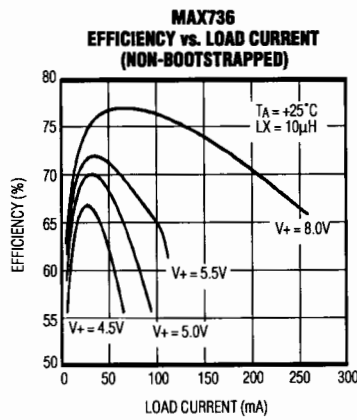
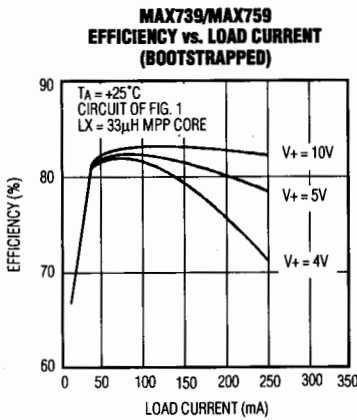
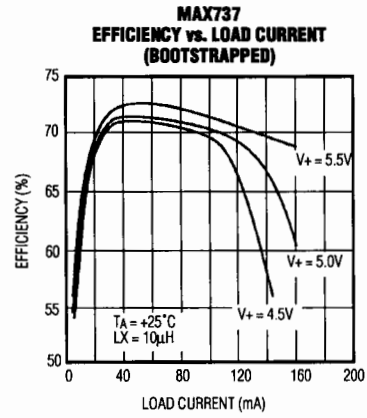
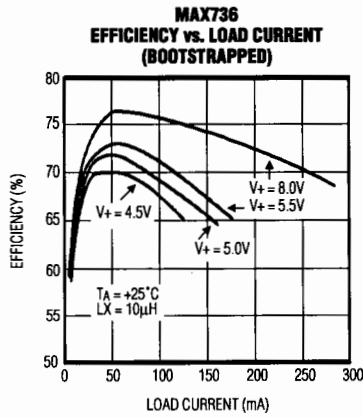
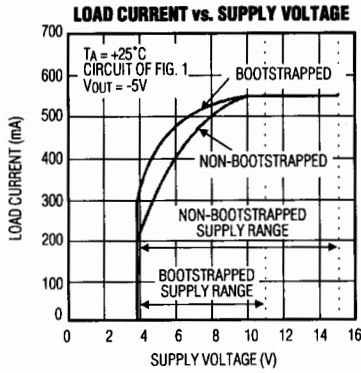

-5V, -12V, -15V, and Adjustable Inverting Current-Mode PWM Regulators

Typical Operating Characteristics (continued)

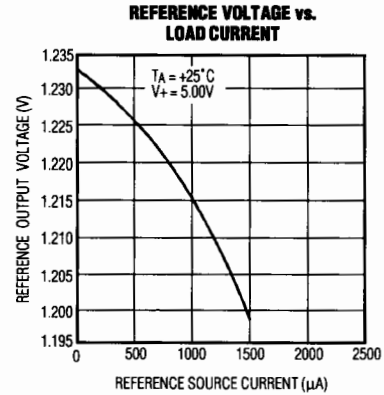
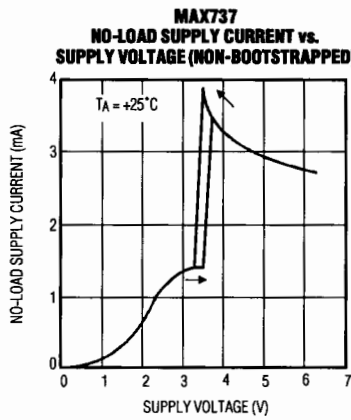
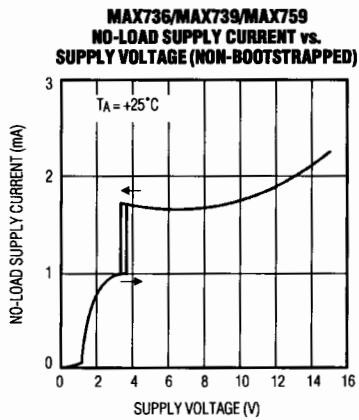

Pin Description

PIN		NAME	FUNCTION
14-PIN DIP	16-PIN SO		
1, 13, 14	1, 15, 16	V+	Positive Supply-Voltage Inputs. Connect all V+ pins together. Bypass with at least a 0.1µF capacitor close to V+ and GND pins.
2	2	SHDN	Shutdown Control. V+ = normal operation, GND = shutdown.
3	3	VREF	Reference Voltage Output = +1.23V. Supplies up to 125µA for external loads.
4, 6	4, 5, 6	N.C.	No Connect. Not internally connected.
5	7	SS	Soft-Start
7	8	CC	Compensation Input. CC is the input of the error amplifier, and is held at virtual ground. For the MAX759, CC is connected to an external resistor divider.
8	9	VOUT	Output Voltage feedback terminal (actually an input). Connected to internal resistors (MAX736/737/739 only). Do not connect on MAX759.
9	10	DRV-	Negative Drive Voltage Input is the negative supply rail for the push-pull stage that drives the internal power FET.
10	11	GND	Ground
11, 12	12, 13, 14	LX	Switch Output – internal P-channel MOSFET drain. Connect all LX pins together.

-5V, -12V, -15V, and Adjustable Inverting Current-Mode PWM Regulators

MAX736/MAX737/MAX739/MAX759

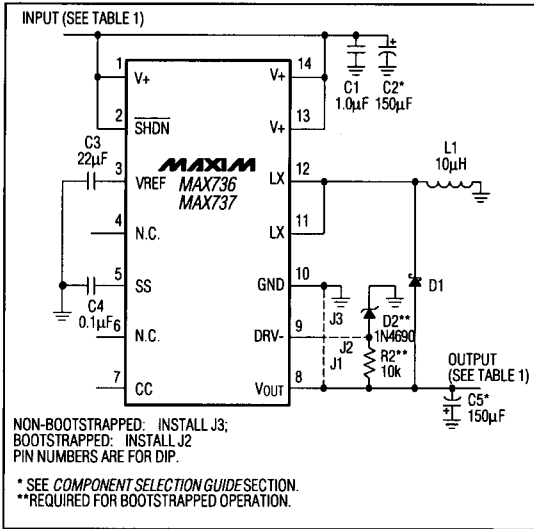

Figure 1a. MAX736/MAX737 Standard Application Circuit (Through-Hole Components)

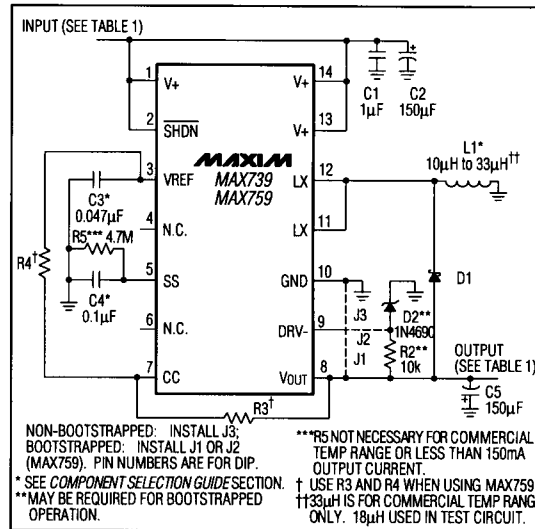

Figure 1b. MAX739/MAX759 Standard Application Circuit (Through-Hole Components)

Table 1. Standard Application Test Circuit Parameters

Device	V+ Range (V)		Output Voltage (V)	Diode D1
	Bootstrapped	Non-Bootstrapped		
MAX736	4 to 8.6	4 to 8.6	-12	1N5818
MAX737	4 to 5.5	4 to 5.5	-15	1N5818
MAX739/MAX759	4 to 11	4 to 15	-5	1N5817/1N5818

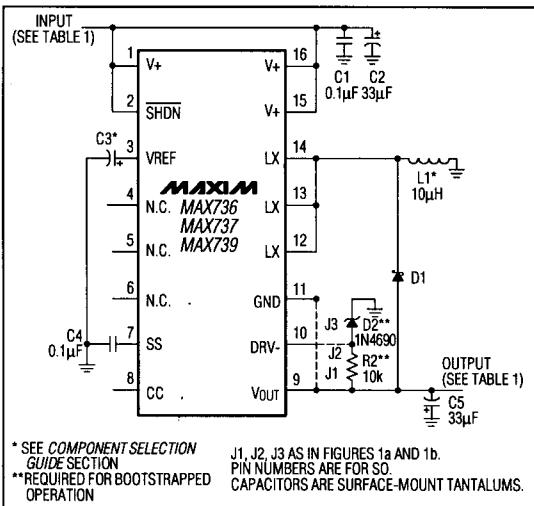

Figure 2. Standard Application Circuit (Surface-Mount Components)

Detailed Description

Operating Principle

The MAX736/MAX737/MAX739/MAX759 are monolithic CMOS ICs containing a current-mode PWM controller and a 1.5A P-channel power MOSFET. Current-mode control provides excellent line-transient response and AC stability. The switch transistor is a current-sensing MOSFET that splits off a fraction of the total source current for current-limit detection.

Basic Application Circuits

Figures 1a and 1b show the standard application circuits, using through-hole components, for the MAX736/MAX737 and the MAX739/MAX759 respectively. The surface-mount standard application circuit is shown in Figure 2. Refer to the *Component Selection Guide* section for application-specific circuit components.

-5V, -12V, -15V, and Adjustable Inverting Current-Mode PWM Regulators

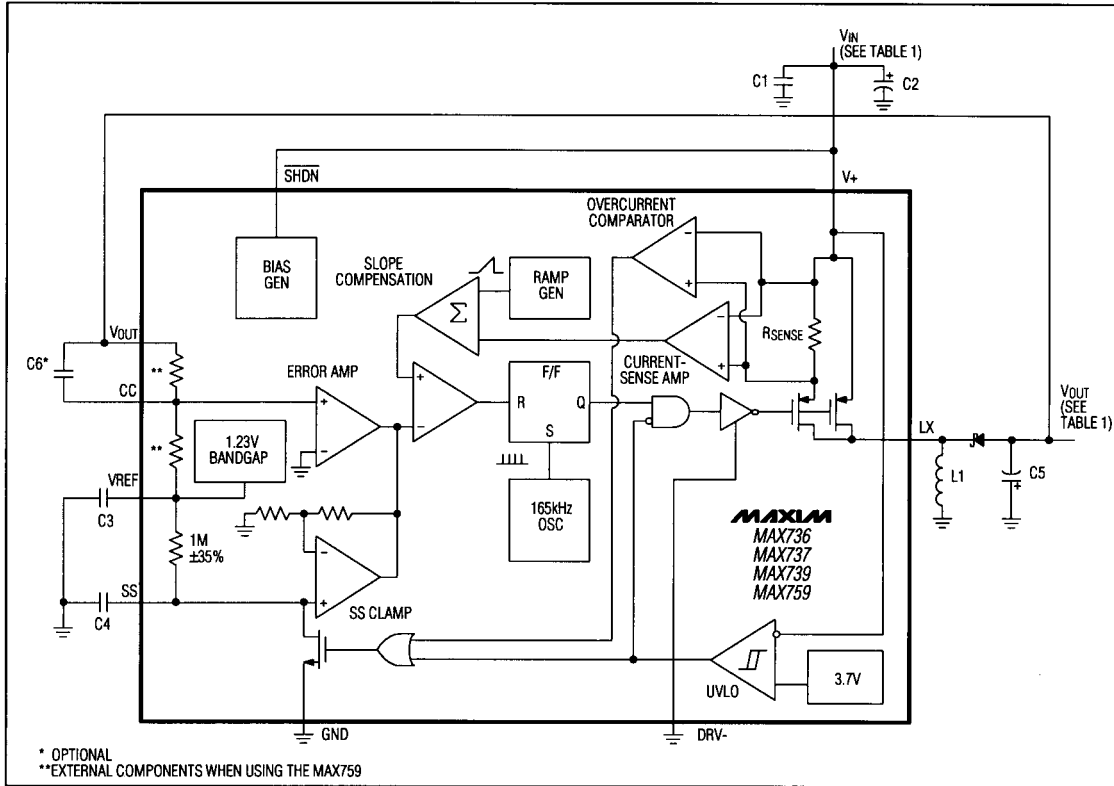

Figure 3. Detailed Block Diagram

Bootstrapped/Non-Bootstrapped Modes

The most important decision in configuring a MAX736/MAX737/MAX739/MAX759 circuit is whether to operate in bootstrapped (DRV- connected to a negative voltage) or non-bootstrapped (DRV- connected to GND) mode. The DRV- connection determines the input voltage range, available output power, and quiescent supply current as described in the *Typical Operating Characteristics* and *Electrical Characteristics*. DRV- connects to the negative supply rail of the driver stage that drives the internal power MOSFET gate. Increasing the negative voltage applied to DRV- reduces MOSFET on resistance, but the supply current is higher due to the higher gate-source voltage swing. Do not exceed the *Absolute Maximum Ratings* specification for the voltage difference between V+ and DRV- (17V). Intermediate bootstrap voltage levels appropriate for the MAX736/MAX737/MAX759 are obtained by using a zener shunt (Figure 4).

Continuous-/Discontinuous-Conduction Modes

The maximum duty cycle is 90%, so the circuit can be operated in continuous-conduction mode (CCM) or discontinuous-conduction mode (DCM) by selecting higher or lower inductor values. In CCM, the inductor current never decays to zero. In DCM, the inductor current slope is steep enough so it decays to zero before the end of the transistor off time. CCM allows the MAX736/MAX737/MAX739/MAX759 to deliver maximum load current, and is also slightly less noisy than DCM, because it doesn't exhibit the ringing that occurs when the inductor current reaches zero. However, DCM allows for lower output filter capacitor values because there is no continuous-feedback path through the inductor.

-5V, -12V, -15V, and Adjustable Inverting Current-Mode PWM Regulators

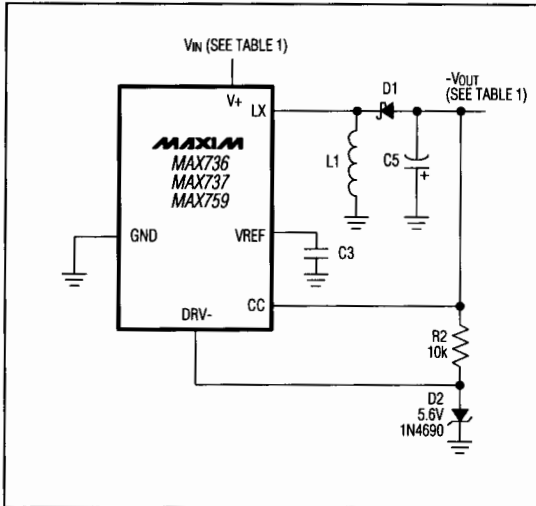

Figure 4. MAX736/MAX737/MAX759 Zener-Bootstrap Scheme

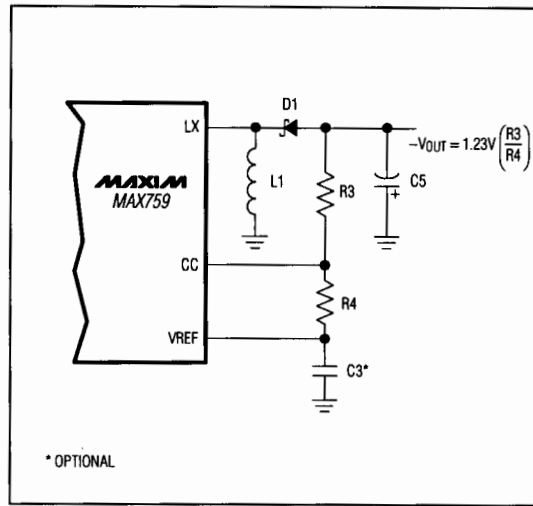

Figure 5. MAX759 Adjustable Output Voltage

MAX736/MAX737/MAX739/MAX759

AC Compensation

Primary compensation for feedback stability is provided by a dominant pole created by the filter capacitance and load resistance. The ESR of the output filter capacitor introduces a zero in the loop response, which tends to destabilize the loop. In the Standard Application Circuits (Figures 1a and 1b), the 150 μ F output filter capacitor (C5) should have a maximum ESR over temperature of 0.5 Ω in order to deliver full load at the minimum supply voltage. Operation at higher input voltages with lower inductor values (low enough to force the circuit to operate in discontinuous-conduction mode) or at lower output current than the full load capability reduces the need for large filter capacitors. Surface-mount capacitors with very low ESR are available. Consequently, smaller capacitance values are adequate (see Figure 2).

Soft-Start Buffer

The voltage applied to SS determines the peak switch-current limit (see *Typical Operating Characteristics*). A capacitor attached to SS ensures an orderly power-up. SS is pulled up to VREF internally through a 1M Ω resistor. The maximum current limit can be fixed externally at a lower than normal value by clamping SS to a voltage less than VREF. An SS cycle is initiated whenever either an under-

voltage lockout or overcurrent fault condition triggers an internal transistor to discharge the SS capacitor to ground. Note that the SS capacitor should be at least 10nF. A typical value is 0.1 μ F. When peak inductor currents at start-up are small, this capacitor may be omitted.

Undervoltage Lockout

The undervoltage lockout allows operation for supply voltages greater than 3.7V typ (4V guaranteed), with 0.25V of hysteresis. Internal control logic holds the output power MOSFET in an off state until the supply rises above the undervoltage threshold, at which time an SS cycle begins.

Inductor Selection

Practical nominal inductor values are in the 10 μ H to 33 μ H range (see *Component Selection Guide* section). Low inductor values force discontinuous-conduction modes (see the *Continuous-/Discontinuous-Conduction Modes* section). The inductor must have a saturation (incremental) current rating greater than the peak switch current obtained from the Peak Switch Current vs. Load Current graph in the *Typical Operating Characteristics*.

The MAX736/MAX737/MAX739/MAX759 contain slope compensation circuitry that improves current-loop stability. Slope compensation is optimized for inductance values in the 10 μ H to 33 μ H range.

-5V, -12V, -15V, and Adjustable Inverting Current-Mode PWM Regulators

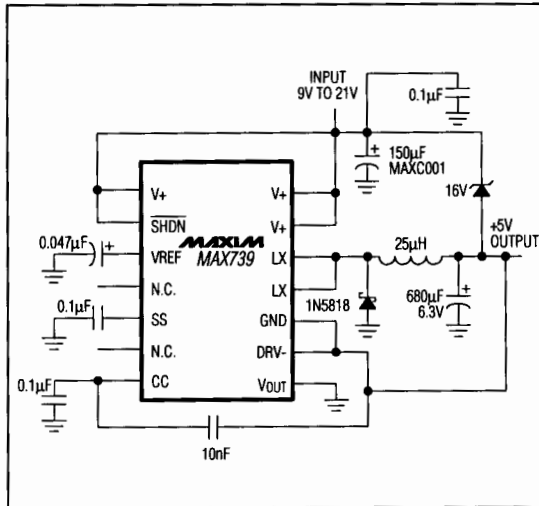

Figure 6. MAX739 +5V Step-Down Application

Adjustable Output

Adjust the MAX759's output voltage from 0V to -15V by selecting the appropriate external resistor divider (Figure 5). Output voltages beyond -15V require a transformer to protect the power MOSFET from overvoltage. With R4 feedback resistor (5kΩ to 15kΩ), a compensation capacitor (typically 10nF) from the output to CC gives best transient-response characteristics. Be careful to observe the *Absolute Maximum Ratings* on the difference between input voltage and output voltage.

Reference Bypass Capacitor

When the input voltage exceeds 11V (i.e. MAX739/MAX759 in non-bootstrapped mode) use 0.047µF for reference capacitor C3. In bootstrapped mode, refer to the *Component Selection Guide* section.

With the MAX736/MAX737, use 4.7µF to 22µF for the reference bypass capacitor. 22µF provides the best stability when large output currents are required.

Printed Circuit Layout and Grounding

Good layout and grounding practices will help achieve low-noise, jitter-free operation. Minimize wiring lengths in the high-current paths, especially the distance between the inductor and the return leads of the filter and bypass capacitors (C2 and C5 of Figures 1 and 2). These high-current ground connections should be brought to a single common point (a "star" ground). Place a low-ESR bypass capacitor directly at the V+ and GND pins of the IC (C1 in Figures 1 and 2).

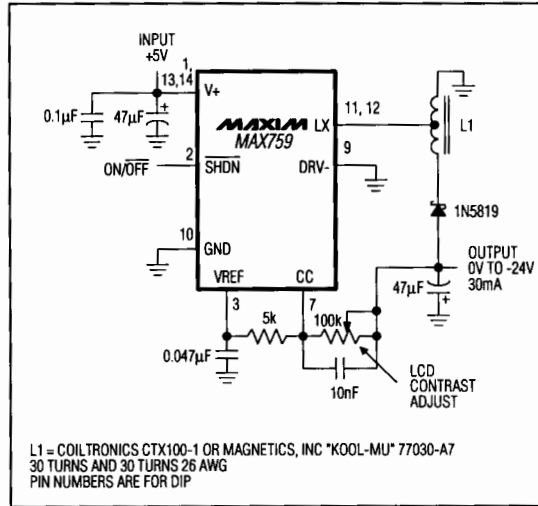

Figure 7. -24V LCD Power Supply

Refer to the MAX739 evaluation kit manual for the recommended layout.

Component Selection Guide

The following guidelines are for component selection when the MAX736/MAX737/MAX739/MAX759 are operated in bootstrapped mode (i.e. DRV- connected to -5.6V (MAX736/MAX737) and DRV- connected to VOUT (MAX739/MAX759)). For non-bootstrapped applications see *Reference Bypass* section.

Surface-Mount Component Selection (see Figure 2) MAX739/MAX759

Over the extended temperature range, use the following component values: L1 = 10µH, C1 = 0.1µF, C2 = 33µF, C3 = 3.3µF (tantalum), C4 = 0.1µF, C5 = 33µF. When $V_{IN} \geq 4.5V$, this circuit provides 200mA ($V_{OUT} = -5V$). Over the commercial temperature range, reference capacitor C3 is not required for load currents less than 150mA.

MAX736/MAX737

Over both the commercial and extended temperature ranges, use the following component values: L1 = 10µH, C1 = 0.1µF, C2 = 33µF (16V), C3 = 22µF (20V), C4 = 0.1µF, C5 = 33µF (20V). C2 and C5 must be low-ESR capacitors such as those available from Matsuo and Sprague. When $V_{IN} \geq 4.5V$, this circuit provides 100mA. When $V_{+} \geq 6V$, the MAX736 provides up to 125mA of output current (note that 6V exceeds the input voltage range of the MAX737).

-5V, -12V, -15V, and Adjustable Inverting Current-Mode PWM Regulators

MAX736/MAX737/MAX739/MAX759

Table 2. Component Suppliers

PRODUCTION METHOD	INDUCTORS	CAPACITORS
Surface Mount	Sumida USA: Phone (708) 956-0666 Japan: Phone (03) 3607-5111 FAX (03) 3607-5428 CD54-330 (33 μ H) CD54-100 (10 μ H) Coiltronics Phone (305) 781-8900 FAX (305) 782-4163 CTX 100 series	Matsuo USA: Phone (714) 969-2491 FAX (714) 960-6492 Japan: Phone (06) 332-0871 267 series Sprague Electric Company USA: Phone (603) 224-1961 FAX (603) 224-1430 595D Series
Miniature Through-Hole	Sumida USA: Phone (708) 956-0666 Japan: Phone (03) 3607-5111 FAX (03) 3607-5428 RCH654-330 (33 μ H) RCH108-330 (33 μ H)	Sanyo Os-Con USA: Phone (619) 661-6322 Japan: Phone (0720) 70-1005 FAX (0720) 70-1174 OS-CON series Low ESR Organic Semiconductor
Through-Hole	Renco Phone (516) 586-5566 FAX (516) 586-5562 RL 1284-33 (33 μ H)	Nichicon Phone (708) 843-7500 FAX (708) 843-2798 PL series Low ESR Electrolytics United Chemi-Con Phone (708) 696-2000 FAX (708) 640-6311 LXF series

For wide temperature applications using through-hole components, organic semiconductor capacitors are recommended (C2 and C5 in Figure 1). These capacitors maintain low ESR across their operating temperature range.

**Through-Hole Extended Temperature Range
Component Selection (see Figure 1)**

MAX739/MAX759

Use the following component values: L1 = 18 μ H, C1 = 1 μ F, C2 = 150 μ F (OS-CON), C3 = 22 μ F (tantalum), C4 = 1.0 μ F, C5 = 220 μ F (OS-CON), R5 = 4.7M Ω . This circuit provides up to 250mA ($V_{OUT} = -5V$) when $V_{IN} \geq 4.5V$, and up to 300mA when $V_{IN} \geq 6V$. Note that this is the only configuration that uses resistor R5. For output currents up to 150mA, C4 can be reduced to 0.1 μ F and R5 can be omitted.

MAX736/MAX737

Use the following component values: L1 = 10 μ H, C1 = 1.0 μ F, C2 = 220 μ F (OS-CON), C3 = 22 μ F (tantalum), C4 = 0.1 μ F, C5 = 100 μ F (OS-CON). When $V_{IN} \geq 4.5V$, the circuit provides 100mA. When V_+ is $\geq 6V$, the MAX736 provides up to 125mA of output current.

**Through-Hole Commercial Temperature Range
Component Selection (see Figure 1)**

MAX739/MAX759

Use the following component values: L1 = 10 μ H to 33 μ H, C1 = 1 μ F, C2 & C5 = 150 μ F (35V, Nichicon), C3 = 0 μ F to 2.2 μ F, C4 = 0.1 μ F.

With L1 = 10 μ H and C3 omitted, when $V_{IN} \geq 4.5V$, the circuit provides up to 200mA. When $V_{IN} \geq 6V$, the circuit provides up to 250mA.

When L1 = 15 μ H to 33 μ H, C3 = 2.2 μ F, and $V_{IN} \geq 4.5V$, the circuit provides 250mA. When V_{IN} is $\geq 6V$, the circuit provides up to 300mA. If C3 is not used, the output current capability is reduced by approximately 50mA.

MAX736/MAX737

Use the following component values: L1 = 10 μ H, C1 = 1.0 μ F, C2 & C5 = 150 μ F (35V, Nichicon), C3 = 22 μ F, C4 = 0.1 μ F. When $V_{IN} \geq 4.5V$, the circuit provides 100mA. When V_+ is $\geq 6V$, the MAX736 provides up to 125mA of output current.

-5V, -12V, -15V, and Adjustable Inverting Current-Mode PWM Regulators

Applications Information

+5V Step-Down Application

The MAX739/MAX759 can operate as step-down (buck) regulators with a positive output (Figure 6). Because the supply current flows into the load, this +5V step-down circuit offers good efficiency even at low load currents: 60% to 85% from 3mA, up to the full-load capability of 1A. It requires a minimum load of 3mA. The input voltage range is 9V to 21V. If the input does not exceed 15V, ground DRV- for higher efficiency and remove the zener.

-24V LCD Power Supply

The LCD power supply circuit of Figure 7 generates an adjustable negative voltage for powering small LCD displays, and will deliver 30mA at -24V. Typical efficiency at 30mA is 80%. A simple autotransformer safely steps up the output voltage beyond the voltage breakdown rating of the internal power MOSFET. The autotransformer (tapped inductor) specified on the schematic is a miniature (0.25" diameter) toroid. This autotransformer approach is slightly better than a flyback transformer due to superior magnetic coupling and a reduction in the number of turns. Refer to the MAX759LCDKIT-SO power supply evaluation kit manual and Application Note.

Ordering Information (continued)

PART	TEMP. RANGE	PIN-PACKAGE
MAX739CPD	0°C to +70°C	14 Plastic DIP
MAX739CWE	0°C to +70°C	16 Wide SO
MAX739C/D	0°C to +70°C	Dice*
MAX739EPD	-40°C to +85°C	14 Plastic DIP
MAX739EWE	-40°C to +85°C	16 Wide SO
MAX739MJD	-55°C to +125°C	14 CERDIP**
MAX759CPD	0°C to +70°C	14 Plastic DIP
MAX759CWE	0°C to +70°C	16 Wide SO
MAX759C/D	0°C to +70°C	Dice*
MAX759EPD	-40°C to +85°C	14 Plastic DIP
MAX759EWE	-40°C to +85°C	16 Wide SO
MAX759MJD	-55°C to +125°C	14 CERDIP**

*Contact factory for dice specifications.

**Contact factory for availability and processing to MIL-STD-883.

Pin Configurations (continued)

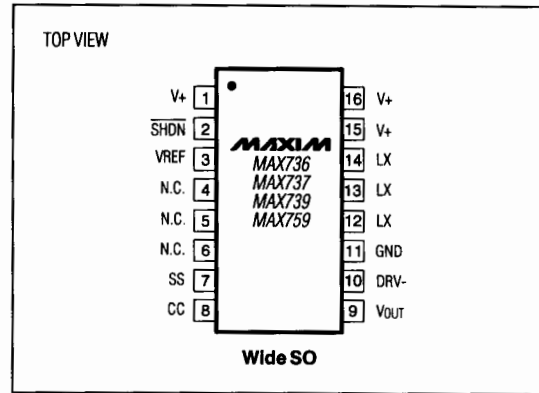

Chip Topography

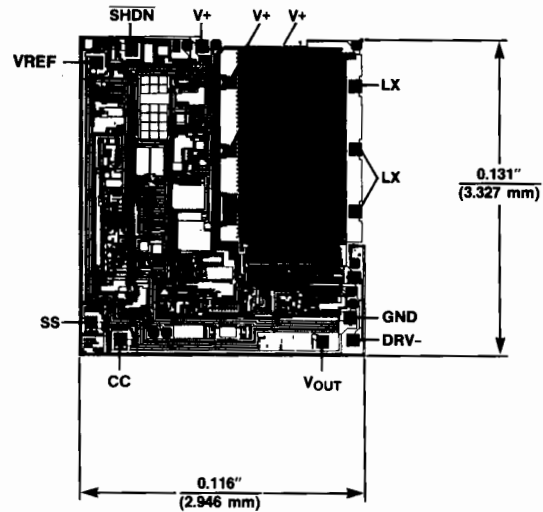

NOTE: TRANSISTOR COUNT: 274;
CONNECT SUBSTRATE TO V+.

Looking for pricing, stock, or lifecycle information?

Click below to explore more details on WIN SOURCE:

 [View MAX759CWE+T on WIN SOURCE](#)

 [Maxim Integrated](#) Information

Optimize Your Supply Chain with WIN SOURCE Solutions

-  Global Sourcing Solution
-  Obsolete Management
-  Cost Control Management
-  Shortage Management
-  Alternative Solution
-  Excess Inventory Management