



THE DATASHEET OF STL30P3LLH6



P-channel 30 V, 0.024 Ω typ., 9 A STripFET™ VI DeepGATE™ Power MOSFET in a PowerFLAT™ 5x6 package

Datasheet – preliminary data



Figure 1. Internal schematic diagram

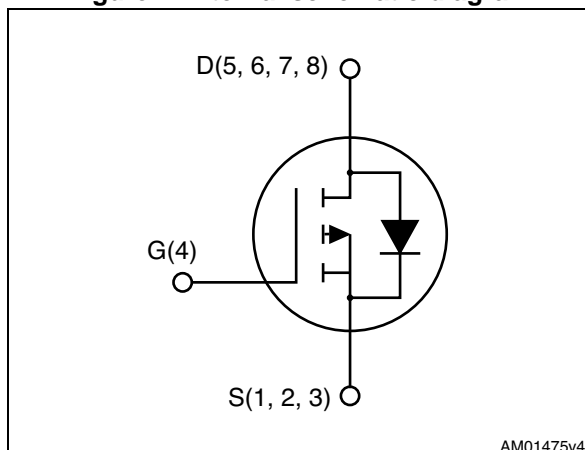

Features

Order code	V _{DS}	R _{DS(on)} max	I _D	P _{TOT}
STL30P3LLH6	30 V	0.03 Ω	9 A	4.8 W

- R_{DS(on)} * Q_g industry benchmark
- Extremely low on-resistance R_{DS(on)}
- High avalanche ruggedness
- Low gate drive power losses

Applications

- Switching applications

Description

This device is a P-channel Power MOSFET developed using the 6th generation of STripFET™ DeepGATE™ technology, with a new gate structure. The resulting Power MOSFET exhibits the lowest R_{DS(on)} in all packages.

Table 1. Device summary

Order code	Marking	Package	Packaging
STL30P3LLH6	30P3L	PowerFLAT™ 5x6	Tape and reel

Note: For the P-channel Power MOSFETs the actual polarity of the voltages and the current must be reversed.

Contents

1	Electrical ratings	3
2	Electrical characteristics	4
2.1	Electrical characteristics (curves)	6
3	Test circuits	8
4	Package mechanical data	9
5	Packaging mechanical data	12
6	Revision history	14



1 Electrical ratings

Table 2. Absolute maximum ratings

Symbol	Parameter	Value	Unit
V_{DS}	Drain-source voltage	30	V
V_{GS}	Gate-source voltage	± 20	V
$I_D^{(1)}$	Drain current (continuous) at $T_C = 25\text{ }^\circ\text{C}$	30	A
$I_D^{(1)}$	Drain current (continuous) at $T_C = 100\text{ }^\circ\text{C}$	18.75	A
$I_D^{(2)}$	Drain current (continuous) at $T_{pcb} = 25\text{ }^\circ\text{C}$	9	A
$I_D^{(2)}$	Drain current (continuous) at $T_{pcb} = 100\text{ }^\circ\text{C}$	6.4	A
$I_{DM}^{(2)(3)}$	Drain current (pulsed)	36	A
$P_{TOT}^{(1)}$	Total dissipation at $T_C = 25\text{ }^\circ\text{C}$	75	W
$P_{TOT}^{(2)}$	Total dissipation at $T_{pcb} = 25\text{ }^\circ\text{C}$	4.8	W
	Derating factor ⁽²⁾	0.03	W/ $^\circ\text{C}$
T_{stg}	Storage temperature	- 55 to 175	$^\circ\text{C}$
T_j	Max. operating junction temperature	175	$^\circ\text{C}$

1. The value is rated according to R_{thj-c}
2. This value is rated according to $R_{thj-pcb}$
3. Pulse width is limited by safe operating area

Table 3. Thermal data

Symbol	Parameter	Value	Unit
$R_{thj-case}$	Thermal resistance junction-case max	2.00	$^\circ\text{C}/\text{W}$
$R_{thj-pcb}^{(1)}$	Thermal resistance junction-pcb, single operation	31.3	$^\circ\text{C}/\text{W}$

1. When mounted on FR-4 board of 1inch², 2oz Cu, steady state

Note: For the P-channel Power MOSFETs the actual polarity of the voltages and the current must be reversed.

2 Electrical characteristics

($T_C = 25\text{ °C}$ unless otherwise specified)

Table 4. On /off states

Symbol	Parameter	Test conditions	Min.	Typ.	Max.	Unit
$V_{(BR)DSS}$	Drain-source breakdown voltage	$V_{GS} = 0, I_D = 250\ \mu A$	30			V
I_{DSS}	Zero gate voltage drain current	$V_{GS} = 0, V_{DS} = 30\text{ V}$			1	μA
		$V_{GS} = 0, V_{DS} = 30\text{ V}, T_C = 125\text{ °C}$			10	μA
I_{GSS}	Gate-body leakage current	$V_{DS} = 0, V_{GS} = \pm 20\text{ V}$			± 100	nA
$V_{GS(th)}$	Gate threshold voltage	$V_{DS} = V_{GS}, I_D = 250\ \mu A$	1			V
$R_{DS(on)}$	Static drain-source on-resistance	$V_{GS} = 10\text{ V}, I_D = 4.5\text{ A}$		0.024	0.03	Ω
		$V_{GS} = 4.5\text{ V}, I_D = 4.5\text{ A}$		0.032	0.040	Ω

Table 5. Dynamic

Symbol	Parameter	Test conditions	Min.	Typ.	Max.	Unit
C_{iss}	Input capacitance	$V_{DS} = 25\text{ V}, f = 1\text{ MHz}, V_{GS} = 0$	-	1450	-	pF
C_{oss}	Output capacitance		-	178	-	pF
C_{rss}	Reverse transfer capacitance		-	120	-	pF
Q_g	Total gate charge	$V_{DD} = 24\text{ V}, I_D = 9\text{ A}, V_{GS} = 4.5\text{ V}$	-	12	-	nC
Q_{gs}	Gate-source charge		-	4.4	-	nC
Q_{gd}	Gate-drain charge		-	5	-	nC

Table 6. Switching times

Symbol	Parameter	Test conditions	Min.	Typ.	Max.	Unit
$t_{d(on)}$	Turn-on delay time	$V_{DD} = 24\text{ V}, I_D = 4.5\text{ A}, R_G = 4.7\ \Omega, V_{GS} = 10\text{ V}$	-	15	-	ns
t_r	Rise time		-	15	-	ns
$t_{d(off)}$	Turn-off delay time		-	24	-	ns
t_f	Fall time		-	21	-	ns

Note: For the P-channel Power MOSFETs the actual polarity of the voltages and the current must be reversed.

Table 7. Source drain diode

Symbol	Parameter	Test conditions	Min.	Typ.	Max.	Unit
I_{SD}	Source-drain current		-		9	A
$I_{SDM}^{(1)}$	Source-drain current (pulsed)		-		36	A
$V_{SD}^{(2)}$	Forward on voltage	$I_{SD} = 4.5 \text{ A}$, $V_{GS} = 0$	-		1.1	V
t_{rr}	Reverse recovery time	$I_{SD} = 4.5 \text{ A}$, $di/dt = 100 \text{ A}/\mu\text{s}$ $V_{DD} = 16 \text{ V}$, $T_j = 150 \text{ }^\circ\text{C}$	-	15		ns
Q_{rr}	Reverse recovery charge		-	6.5		nC
I_{RRM}	Reverse recovery current		-	0.9		A

1. Pulse width limited by safe operating area

2. Pulsed: pulse duration = 300 μs , duty cycle 1.5%

Note: For the P-channel Power MOSFETs the actual polarity of the voltages and the current must be reversed.

2.1 Electrical characteristics (curves)

Figure 2. Safe operating area

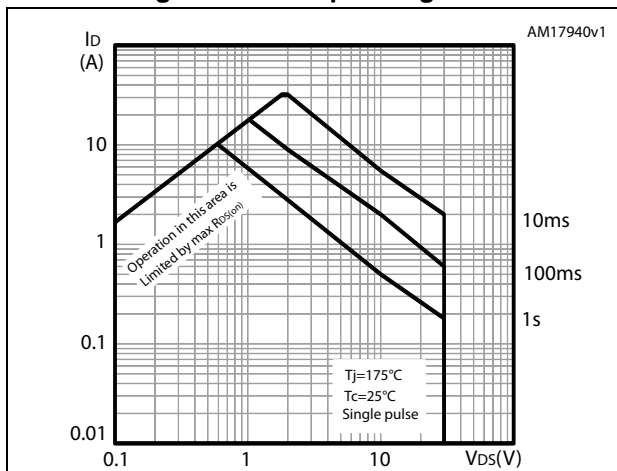

Figure 3. Thermal impedance

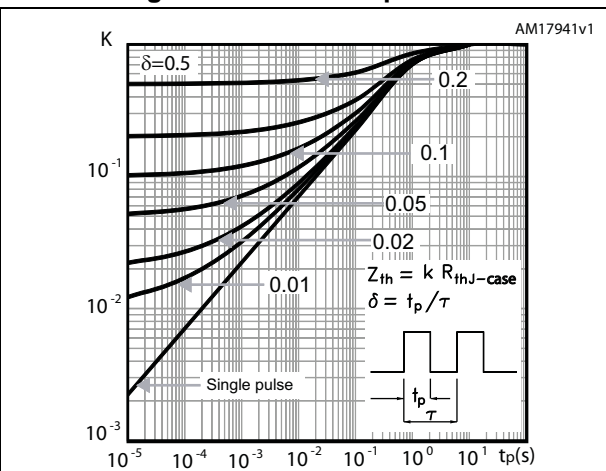

Figure 4. Output characteristics

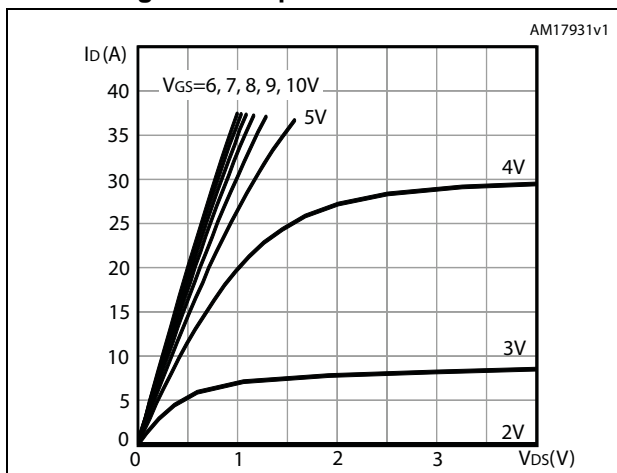

Figure 5. Transfer characteristics

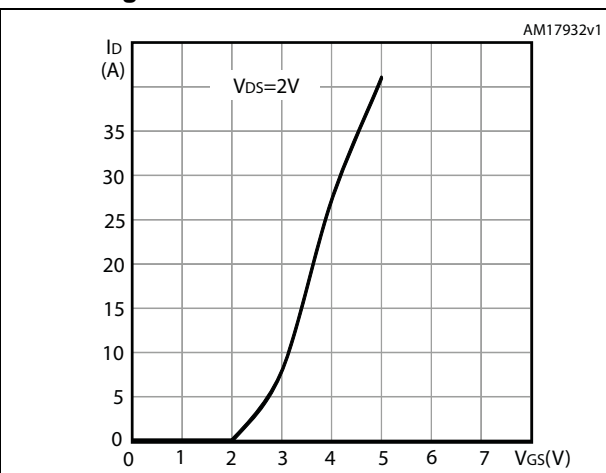

Figure 6. Gate charge vs gate-source voltage

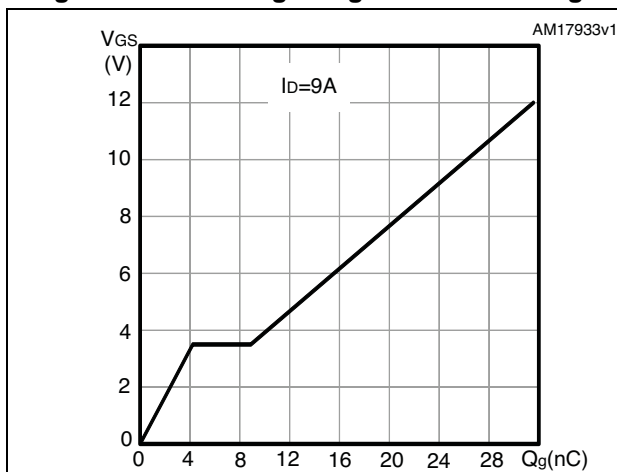

Figure 7. Static drain-source on-resistance

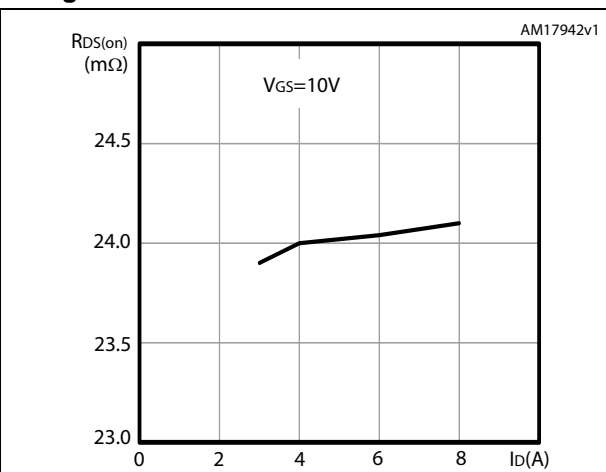

Figure 8. Capacitance variations

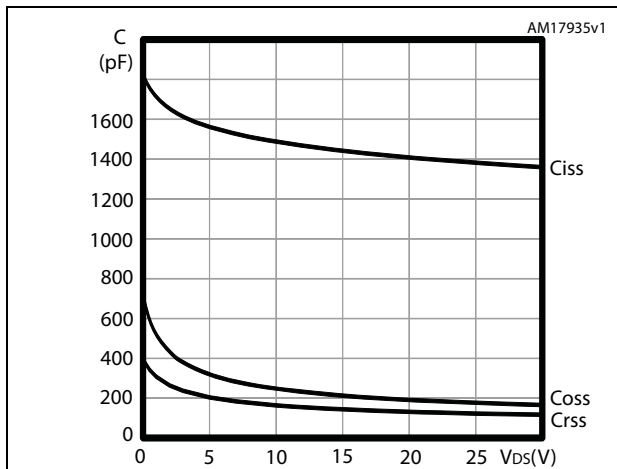

Figure 9. Normalized gate threshold voltage vs temperature

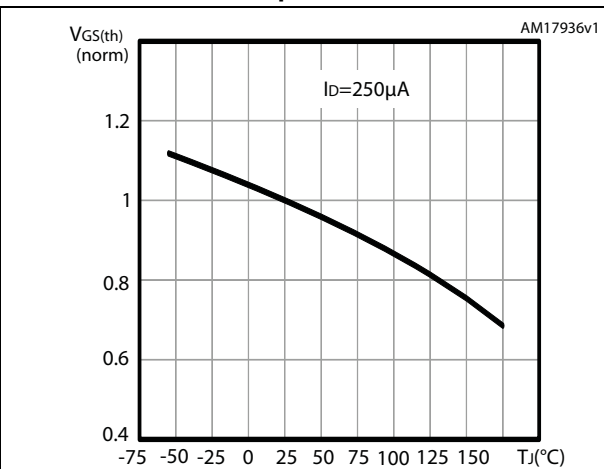

Figure 10. Normalized on-resistance vs temperature

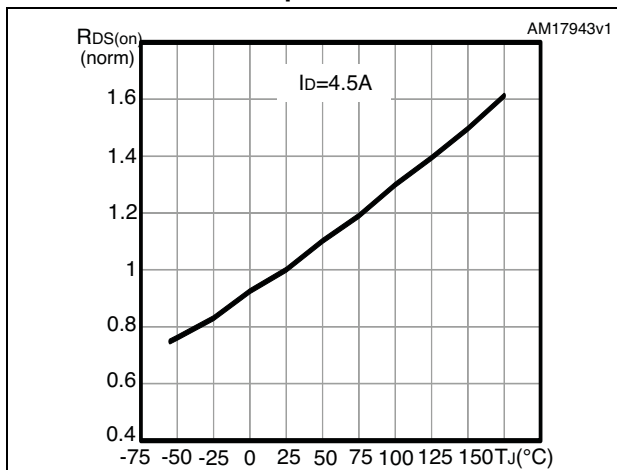

Figure 11. Normalized VDS vs temperature

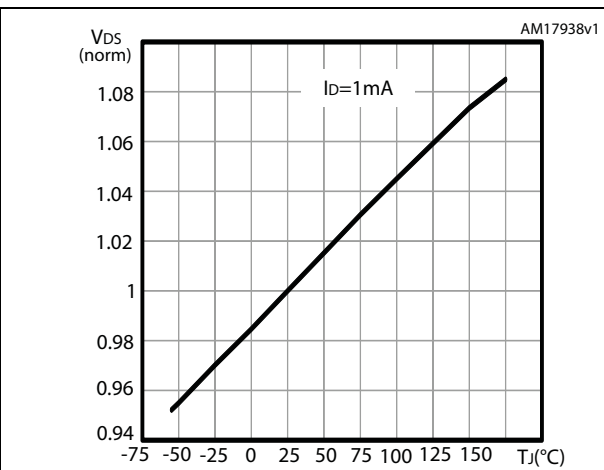
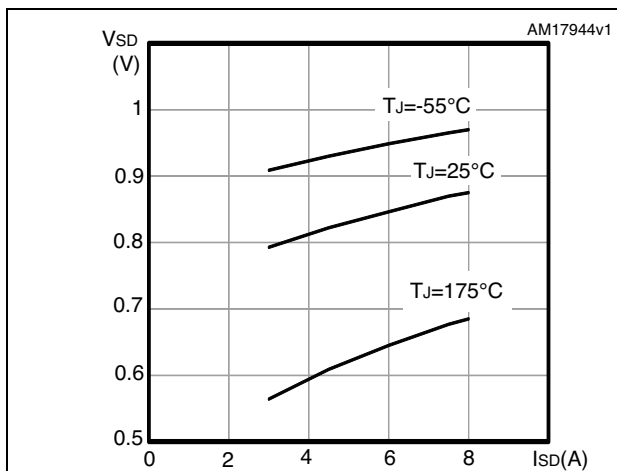

Figure 12. Source-drain diode forward characteristics



3 Test circuits

Figure 13. Switching times test circuit for resistive load

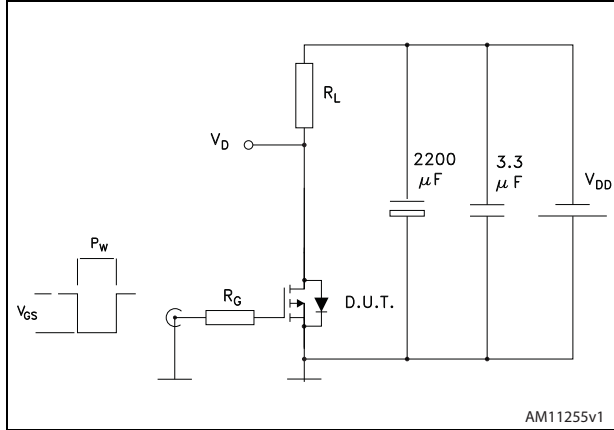

Figure 14. Gate charge test circuit

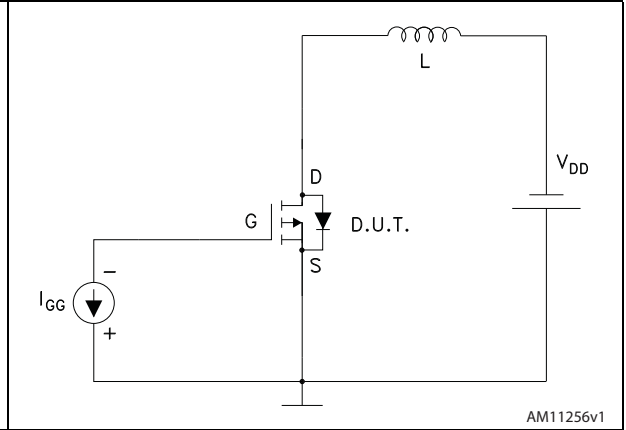
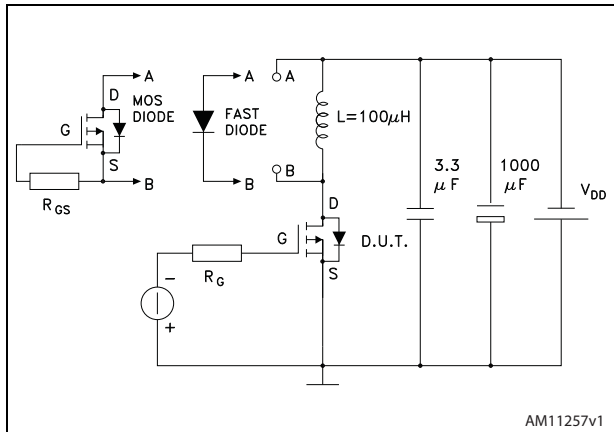

Figure 15. Test circuit for diode recovery behavior



4 Package mechanical data

In order to meet environmental requirements, ST offers these devices in different grades of ECOPACK[®] packages, depending on their level of environmental compliance. ECOPACK[®] specifications, grade definitions and product status are available at: www.st.com. ECOPACK[®] is an ST trademark.

Figure 16. PowerFLAT™ 5x6 type S-R drawing

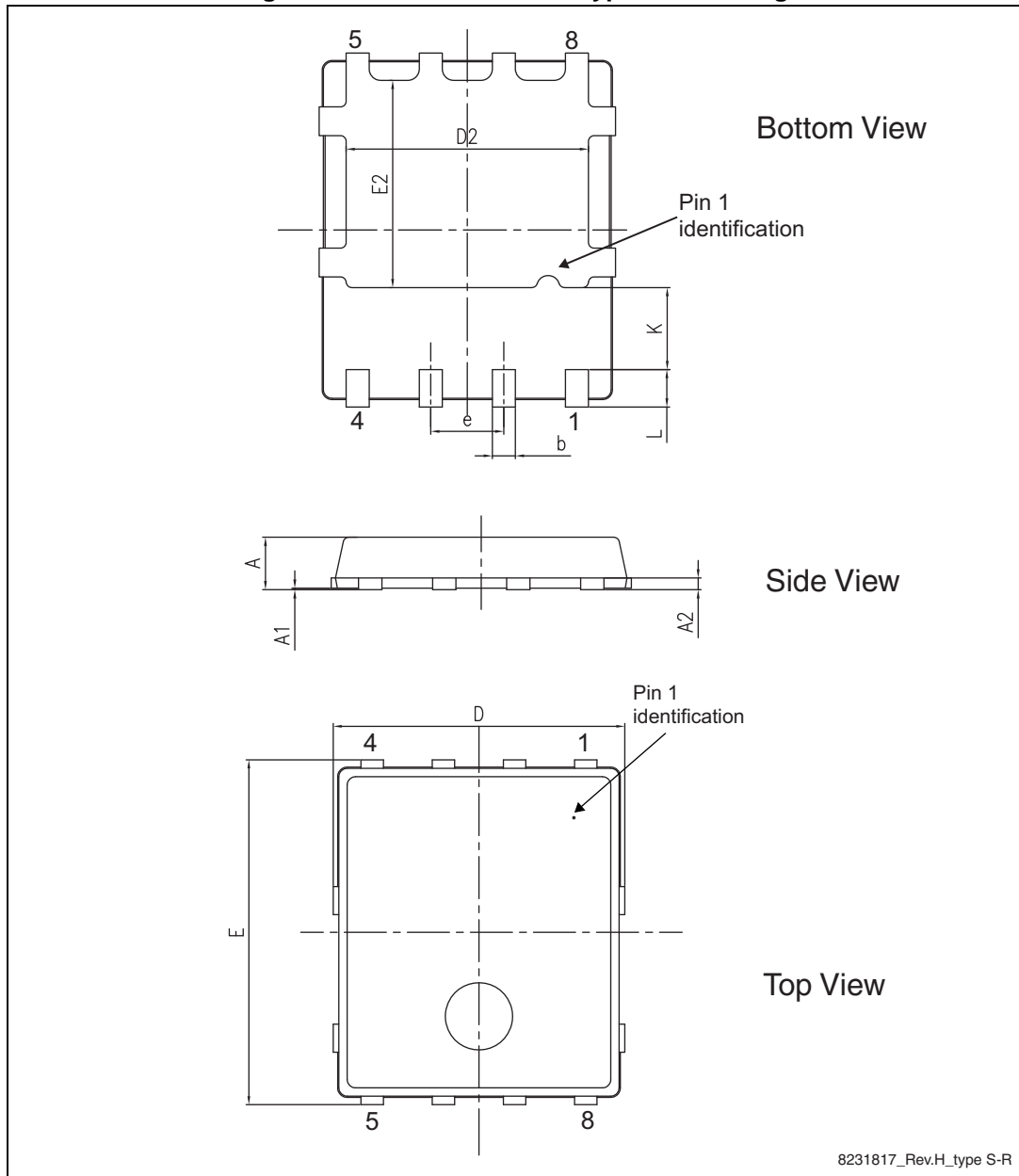

5 Packaging mechanical data

Figure 18. PowerFLAT™ 5x6 tape(a)

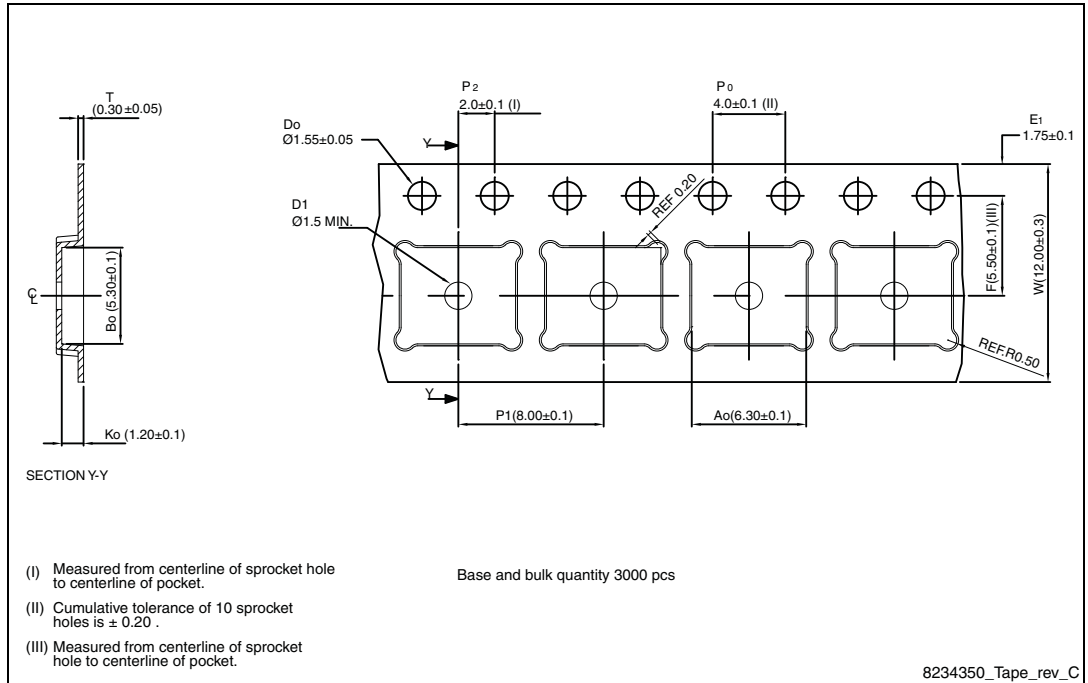
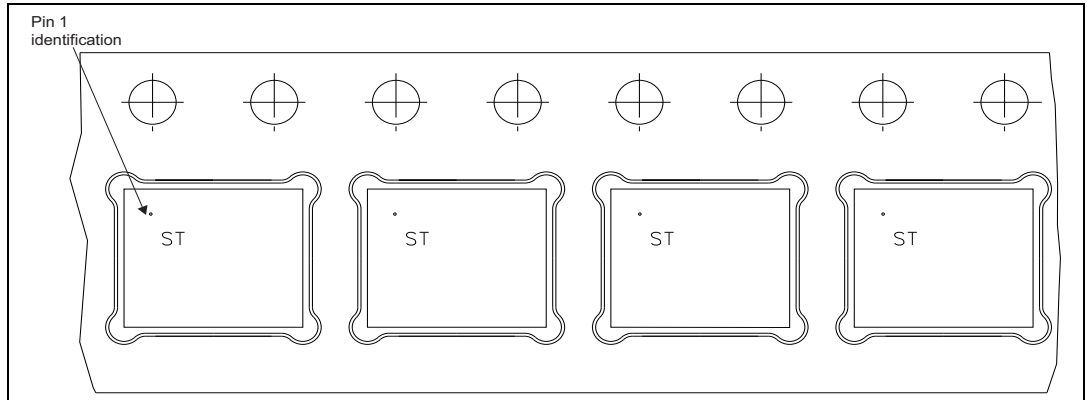
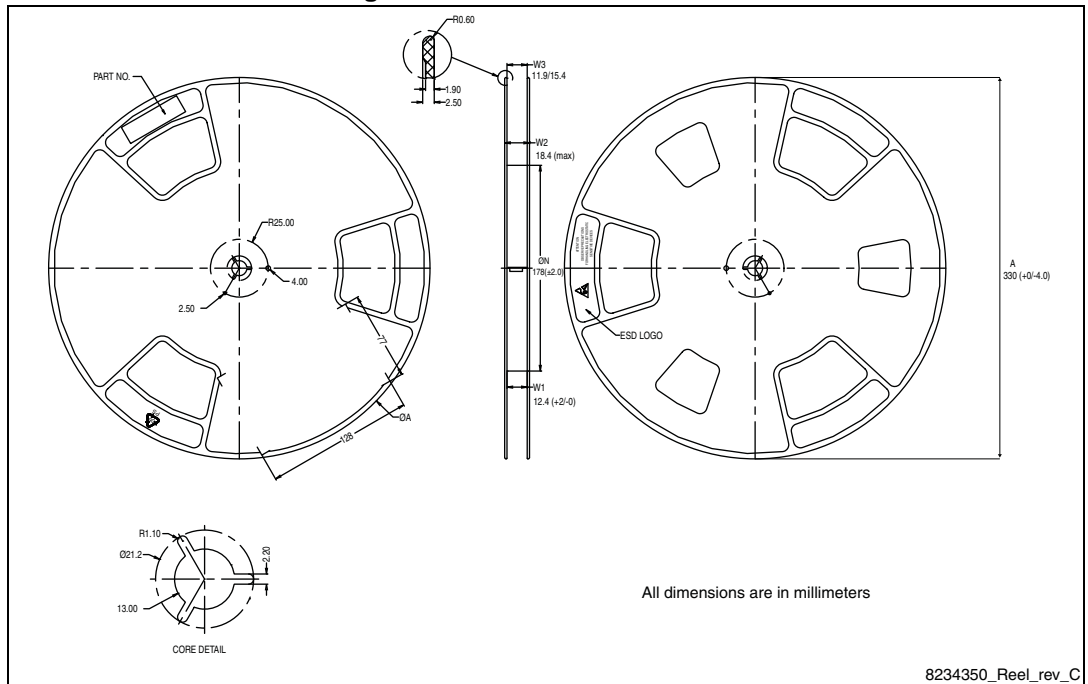

Figure 19. PowerFLAT™ 5x6 package orientation in carrier tape



a. All dimensions are in millimeters.

Figure 20. PowerFLAT™ 5x6 reel



6 Revision history

Table 9. Document revision history

Date	Revision	Changes
20-Mar-2013	1	First release.
28-Nov-2013	2	<ul style="list-style-type: none"> - Modified: title - Modified: I_D, P_{TOT} values and Figure 1 in cover page - Modified: V_{GS}, I_D (at $T_{pcb}=125\text{ °C}$ and $T_{pcb}=100\text{ °C}$), I_{DM}, P_{TOT} (at $T_c=25\text{ °C}$ and $T_{pcb}=25\text{ °C}$) and T_{stg} in Table 2 - Modified: $R_{thj-pcb}$ value in Table 3 - Modified: I_{GSS} (V_{GS} - test condition) value and I_D (for $R_{DS(on)}$) in Table 4 - Modified: Q_g value in Table 5 - Modified: I_D value in Table 6 - Modified: I_{SD} and I_{SDM} in Table 7 - Added: Section 2.1: Electrical characteristics (curves) - Minor text changes
08-Jan-2014	3	<ul style="list-style-type: none"> - Modified: T_j value in Table 2 - Modified: Figure 6 - Updated: Section 4: Package mechanical data - Minor text changes

Please Read Carefully:

Information in this document is provided solely in connection with ST products. STMicroelectronics NV and its subsidiaries ("ST") reserve the right to make changes, corrections, modifications or improvements, to this document, and the products and services described herein at any time, without notice.

All ST products are sold pursuant to ST's terms and conditions of sale.

Purchasers are solely responsible for the choice, selection and use of the ST products and services described herein, and ST assumes no liability whatsoever relating to the choice, selection or use of the ST products and services described herein.

No license, express or implied, by estoppel or otherwise, to any intellectual property rights is granted under this document. If any part of this document refers to any third party products or services it shall not be deemed a license grant by ST for the use of such third party products or services, or any intellectual property contained therein or considered as a warranty covering the use in any manner whatsoever of such third party products or services or any intellectual property contained therein.

UNLESS OTHERWISE SET FORTH IN ST'S TERMS AND CONDITIONS OF SALE ST DISCLAIMS ANY EXPRESS OR IMPLIED WARRANTY WITH RESPECT TO THE USE AND/OR SALE OF ST PRODUCTS INCLUDING WITHOUT LIMITATION IMPLIED WARRANTIES OF MERCHANTABILITY, FITNESS FOR A PARTICULAR PURPOSE (AND THEIR EQUIVALENTS UNDER THE LAWS OF ANY JURISDICTION), OR INFRINGEMENT OF ANY PATENT, COPYRIGHT OR OTHER INTELLECTUAL PROPERTY RIGHT.

ST PRODUCTS ARE NOT DESIGNED OR AUTHORIZED FOR USE IN: (A) SAFETY CRITICAL APPLICATIONS SUCH AS LIFE SUPPORTING, ACTIVE IMPLANTED DEVICES OR SYSTEMS WITH PRODUCT FUNCTIONAL SAFETY REQUIREMENTS; (B) AERONAUTIC APPLICATIONS; (C) AUTOMOTIVE APPLICATIONS OR ENVIRONMENTS, AND/OR (D) AEROSPACE APPLICATIONS OR ENVIRONMENTS. WHERE ST PRODUCTS ARE NOT DESIGNED FOR SUCH USE, THE PURCHASER SHALL USE PRODUCTS AT PURCHASER'S SOLE RISK, EVEN IF ST HAS BEEN INFORMED IN WRITING OF SUCH USAGE, UNLESS A PRODUCT IS EXPRESSLY DESIGNATED BY ST AS BEING INTENDED FOR "AUTOMOTIVE, AUTOMOTIVE SAFETY OR MEDICAL" INDUSTRY DOMAINS ACCORDING TO ST PRODUCT DESIGN SPECIFICATIONS. PRODUCTS FORMALLY ESCC, QML OR JAN QUALIFIED ARE DEEMED SUITABLE FOR USE IN AEROSPACE BY THE CORRESPONDING GOVERNMENTAL AGENCY.

Resale of ST products with provisions different from the statements and/or technical features set forth in this document shall immediately void any warranty granted by ST for the ST product or service described herein and shall not create or extend in any manner whatsoever, any liability of ST.

ST and the ST logo are trademarks or registered trademarks of ST in various countries.

Information in this document supersedes and replaces all information previously supplied.

The ST logo is a registered trademark of STMicroelectronics. All other names are the property of their respective owners.

© 2014 STMicroelectronics - All rights reserved



STMicroelectronics group of companies

Australia - Belgium - Brazil - Canada - China - Czech Republic - Finland - France - Germany - Hong Kong - India - Israel - Italy - Japan - Malaysia - Malta - Morocco - Philippines - Singapore - Spain - Sweden - Switzerland - United Kingdom - United States of America

www.st.com

Looking for pricing, stock, or lifecycle information?

Click below to explore more details on WIN SOURCE:

-  [View STL30P3LLH6 on WIN SOURCE](#)
-  [STMicroelectronics](#) Information

Optimize Your Supply Chain with WIN SOURCE Solutions

-  Global Sourcing Solution
-  Obsolete Management
-  Cost Control Management
-  Shortage Management
-  Alternative Solution
-  Excess Inventory Management