

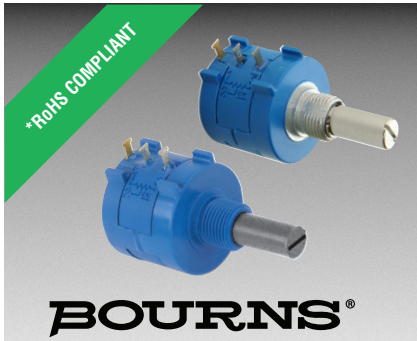

THE DATASHEET OF
3590S-2-503L





Features

- Bushing mount
 - Optional AR pin feature
 - Plastic or metal shaft and bushings
 - Wirewound
 - Solder lugs or PC pins
 - Sealable (Full body seal)
 - Designed for use in HMI applications
- RoHS compliant*

3590 - Precision Potentiometer

Electrical Characteristics¹

Standard Resistance Range.....	200 to 100 K ohms
Total Resistance Tolerance.....	±5 %
Independent Linearity.....	±0.25 %
Effective Electrical Angle.....	3600 ° +10 °, -0 °
Absolute Minimum Resistance.....	1 ohm or 0.1 % maximum (whichever is greater)
Noise.....	100 ohms ENR maximum
Dielectric Withstanding Voltage (MIL-STD-202, Method 301) Sea Level.....	1,500 VAC minimum
Power Rating (Voltage Limited By Power Dissipation or 450 VAC, Whichever is Less)	
+40 °C.....	2 watts
+125 °C.....	0 watt
Insulation Resistance (500 VDC).....	1,000 megohms minimum
Resolution.....	See recommended part numbers

Environmental Characteristics¹

Operating Temperature Range.....	-40 °C to +125 °C
Storage Temperature Range.....	-55 °C to +125 °C
Temperature Coefficient Over Storage Temperature Range ²	±50 ppm/°C maximum/unit
Vibration.....	15 G
Wiper Bounce.....	0.1 millisecond maximum
Shock.....	50 G
Wiper Bounce.....	0.1 millisecond maximum
Load Life.....	1,000 hours, 2 watts
Total Resistance Shift.....	±2 % maximum
Rotational Life (No Load).....	1,000,000 shaft revolutions
Total Resistance Shift.....	±5 % maximum
Moisture Resistance (MIL-STD-202, Method 103, Condition B)	
Total Resistance Shift.....	±2 % maximum
IP Rating	
Sealed Versions (-3, -4, -7, and -8).....	IP 65
Unsealed Versions (-1 -2, -5, and -6).....	IP 40
Moisture Sensitivity Level.....	1
ESD Classification (HBM).....	N/A

Mechanical Characteristics¹

Stop Strength.....	.45 N-cm (64 oz.-in.) minimum
Mechanical Angle.....	3600 ° +10 °, -0 °
Torque	
Starting & Running.....	0.85 N-cm (1.2 oz.-in.) maximum (unsealed) 1.41 N-cm (2.0 oz.-in.) maximum (sealed)
Mounting.....	55-80 N-cm (5-7 lb.-in.) (plastic) 90-113 N-cm (8-10 in.-lb.) (metal)
Shaft Runout.....	0.13 mm (0.005 in.) T.I.R.
Lateral Runout.....	0.20 mm (0.008 in.) T.I.R.
Shaft End Play.....	0.25 mm (0.010 in.) T.I.R.
Shaft Radial Play.....	0.13 mm (0.005 in.) T.I.R.
Pilot Diameter Runout.....	0.08 mm (0.003 in.) T.I.R.
Backlash.....	1.0 ° maximum
Weight.....	Approximately 19 G
Terminals.....	Solder lugs or PC pins
Soldering Condition	
Manual Soldering.....	96.5Sn/3.0Ag/0.5Cu solid wire or no-clean rosin cored wire; 370 °C (700 °F) max. for 3 seconds
Wave Soldering.....	96.5Sn/3.0Ag/0.5Cu solder with no-clean flux; 260 °C (500 °F) max. for 5 seconds
Wash processes.....	Not recommended
Marking.....	Manufacturer's name and part number, resistance value and tolerance, linearity tolerance, wiring diagram, and date code.
Ganging (Multiple Section Potentiometers).....	1 cup maximum
Hardware.....	One lockwasher and one mounting nut is shipped with each potentiometer.

NOTE: For Anti-rotation pin add 91 after configuration dash number. Example: -2 becomes -291 to add AR pin.

¹ At room ambient: +25 °C nominal and 50 % relative humidity nominal, except as noted.

² Consult manufacturer for complete specification details for resistances below 1k ohms.

*RoHS Directive 2002/95/EC Jan. 27, 2003 including annex and RoHS Recast 2011/65/EU June 8, 2011.

Specifications are subject to change without notice.

Users should verify actual device performance in their specific applications.

The products described herein and this document are subject to specific disclaimers as set forth on the last page of this document, and at www.bourns.com/legal/disclaimer.pdf.

3590 - Precision Potentiometer



Product Dimensions

-1, -3, -5, -7 Configurations

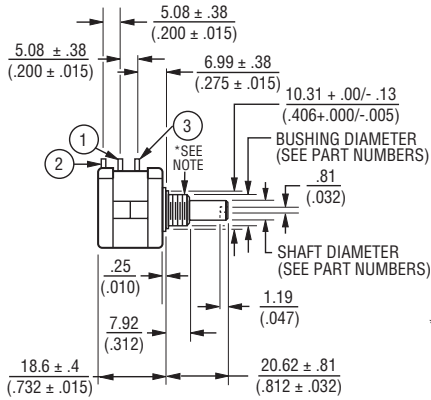

*BUSHING THREAD SPECIFICATIONS:
 -1, -2, -3, -4.....3/8-32 UNF
 -5, -6, -7, -8.....M9 x 0.75-7H

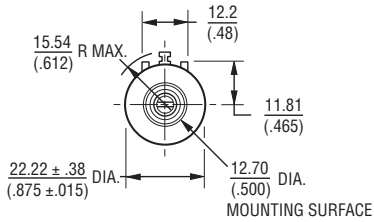

-2, -4, -6, -8 Configurations

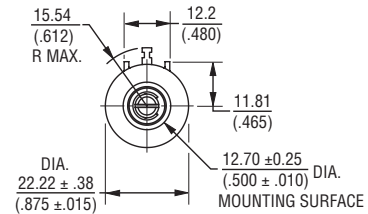
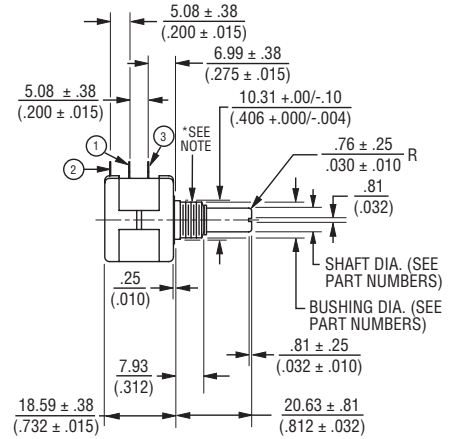

Recommended PCB Layout

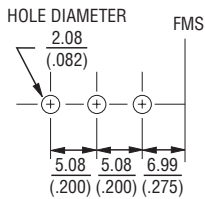

Schematic

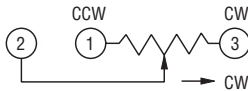

TOLERANCES: EXCEPT WHERE NOTED
 DECIMALS: XX ± .508, .XXX ± .127
 FRACTIONS: ±1/64
 DIMENSIONS: MM (IN.)

Terminal Styles

"P" Terminal Style

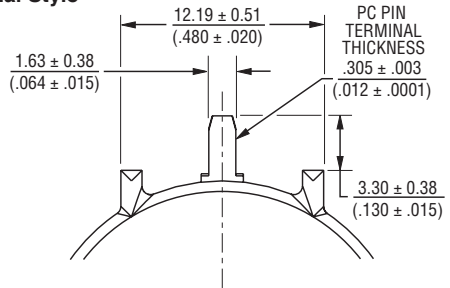

"S" Terminal Style

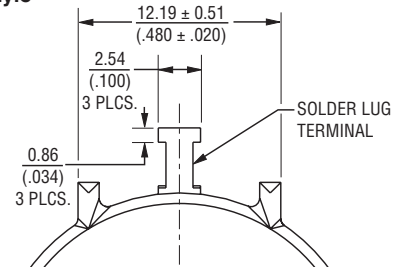

3590 - Precision Potentiometer

BOURNS®

Recommended Part Numbers

(Printed Circuit)	(Solder Lug)	(Solder Lug)	Resistance (Ω)	Resolution (%)
3590P-2-102L	3590S-2-102L	3590S-1-102L	1,000	.029
3590P-2-202L	3590S-2-202L	3590S-1-202L	2,000	.023
3590P-2-502L	3590S-2-502L	3590S-1-502L	5,000	.025
3590P-2-103L	3590S-2-103L	3590S-1-103L	10,000	.020
3590P-2-203L	3590S-2-203L	3590S-1-203L	20,000	.019
3590P-2-503L	3590S-2-503L	3590S-1-503L	50,000	.013
3590P-2-104L	3590S-2-104L	3590S-1-104L	100,000	.009

BOLDFACE LISTINGS ARE IN STOCK AND READILY AVAILABLE THROUGH DISTRIBUTION. FOR OTHER OPTIONS CONSULT FACTORY.
 ROHS IDENTIFIER:
 L = COMPLIANT

Panel Thickness Dimensions

(For Bushing Mount Only)

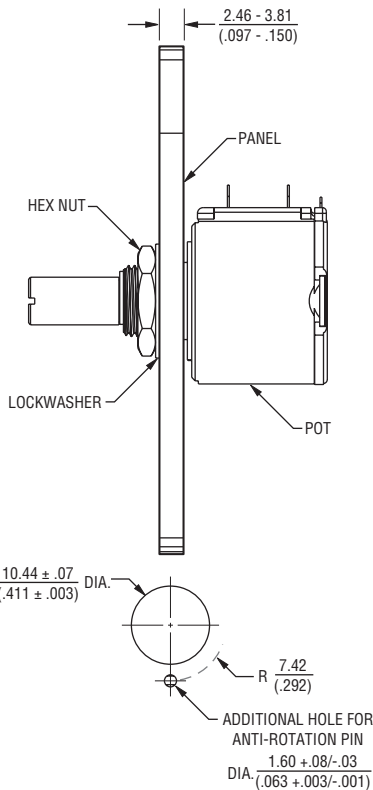

Anti-rotation pin hole is shown at six o'clock position for reference only. The actual location is determined by the customer's application. Refer to the front view of the potentiometer to see the location of the optional A/R pin.

Panel thickness and hole diameters are recommended for best fit. However, customers may adjust the dimensions to suit their specific application.

Shaft & Bushing Configurations

(Bushing - DxL, Shaft - D):

- (-1) Plastic Bushing (3/8 " x 5/16 ") and Shaft (.2480 + .001, - .002)
- (-2) **Metal Bushing (3/8 " x 5/16 ") and Shaft (.2497 + .0000, - .0009)**
- (-3) Sealed, Plastic Bushing (3/8 " x 5/16 ") and Shaft (.2480 + .001, - .002)
- (-4) Sealed, Metal Bushing (3/8 " x 5/16 ") and Shaft (.2497 + .0000, - .0009)
- (-5) Metric, Plastic Bushing (9 mm x 7.94 mm) and Shaft (6 mm + 0, - .076 mm)
- (-6) Metric, Metal Bushing (9 mm x 7.94 mm) and Shaft (6 mm + 0, - .023 mm)
- (-7) Metric, Sealed, Plastic Bushing (9 mm x 7.94 mm) and Shaft (6 mm + 0, - .076 mm)
- (-8) Metric, Sealed, Metal Bushing (9 mm x 7.94 mm) and Shaft (6 mm + 0, - .023 mm)

REV. 11/17

Specifications are subject to change without notice.

Users should verify actual device performance in their specific applications.

The products described herein and this document are subject to specific disclaimers as set forth on the last page of this document, and at www.bourns.com/legal/disclaimer.pdf.

This legal disclaimer applies to purchasers and users of Bourns® products manufactured by or on behalf of Bourns, Inc. and its affiliates (collectively, “Bourns”).

Unless otherwise expressly indicated in writing, Bourns® products and data sheets relating thereto are subject to change without notice. Users should check for and obtain the latest relevant information before placing orders and should verify that such information is current and complete.

The characteristics and parameters of a Bourns® product set forth in its data sheet are based on laboratory conditions, and statements regarding the suitability of products for certain types of applications are based on Bourns’ knowledge of typical requirements in generic applications. The characteristics and parameters of a Bourns® product in a user application may vary from the data sheet characteristics and parameters due to a combination of the Bourns® product with other components in the user’s application or due to the environment of the user application itself. Such characteristics and parameters also can and do vary in different applications and actual performance may vary over time. Users should always verify actual performance of the Bourns® product in their specific devices and applications, and make their own independent judgments about how much additional test margin to design in to compensate for differences between laboratory and real world conditions.

Unless Bourns has explicitly designated an individual Bourns® product as meeting the requirements of a particular industry standard (e.g., ISO/TS 16949) or a particular qualification (e.g., UL listed or recognized), Bourns is not responsible for any failure of an individual Bourns® product to meet requirements of such industry standard or such particular qualification. Users of Bourns® products are responsible for ensuring compliance with safety-related requirements and standards applicable to their applications.

Bourns® products are not recommended, authorized or intended for use in nuclear, lifesaving, life-critical or life-sustaining applications, nor in any other applications where failure or malfunction may result in personal injury, death, or severe property or environmental damage. Unless expressly and specifically approved in writing by two authorized Bourns representatives on a case-by-case basis, use of any Bourns® products in such unauthorized applications is at the user’s sole risk. Life-critical applications include devices identified by the U.S. Food and Drug Administration as Class III devices and generally equivalent classifications outside of the United States.

Bourns® standard products that are designed and tested for use in automotive applications will be described on the applicable data sheets as compliant with the applicable AEC-Q standard. Unless expressly and specifically approved in writing by two authorized Bourns representatives on a case-by-case basis, use of any other Bourns® standard products in an automotive application is not recommended, authorized or intended and will be at the user’s sole risk.

Bourns® standard products are not tested to comply with United States Federal Aviation Administration standards generally or any other generally equivalent governmental organization standard applicable to products designed or manufactured for use in aircraft or space applications. Bourns® standard products that are designed and tested for use in aircraft or space applications will be described on the applicable data sheets as compliant with the RTCA DO-160 standard. Unless expressly and specifically approved in writing by two authorized Bourns representatives on a case-by-case basis, use of any other Bourns® standard product in an aircraft or space application is not recommended, authorized or intended and will be at the user’s sole risk.

The use and level of testing applicable to Bourns® custom products shall be negotiated on a case-by-case basis by Bourns and the user for which such Bourns® custom products are specially designed. Absent a written agreement between Bourns and the user regarding the use and level of such testing, the provisions above applicable to Bourns® standard products shall also apply to such Bourns® custom products.

Users shall not sell, transfer, export or re-export any Bourns® products or technology for use in activities which involve the design, development, production, use or stockpiling of nuclear, chemical or biological weapons or missiles, nor shall they use Bourns® products or technology in any facility which engages in activities relating to such devices. The foregoing restrictions apply to all uses and applications that violate national or international prohibitions, including embargos or international regulations. Further, Bourns® products, technology or technical data may not under any circumstance be exported or re-exported to countries subject to international sanctions or embargoes, and Bourns® products may not, without prior authorization from Bourns and/or the U.S. Government, be resold, transferred, or re-exported to any party not eligible to receive U.S. commodities, software, and technical data.

To the maximum extent permitted by applicable law, Bourns disclaims (i) any and all liability arising out of the application or use of any Bourns® standard product, (ii) any and all liability, including, without limitation, special, punitive, consequential or incidental damages, and (iii) any and all implied warranties, including implied warranties of fitness for particular purpose, non-infringement and merchantability.

For your convenience, copies of this Legal Disclaimer Notice with German, Spanish, Japanese, Traditional Chinese and Simplified Chinese bilingual versions are available at:

Web Page: <http://www.bourns.com/legal/disclaimers-terms-and-policies>

PDF: <http://www.bourns.com/docs/Legal/disclaimer.pdf>

Looking for pricing, stock, or lifecycle information?

Click below to explore more details on WIN SOURCE:

- [View 3590S-2-503L on WIN SOURCE](#)
- [Bourns Inc. Information](#)

Optimize Your Supply Chain with WIN SOURCE Solutions

- ✓ Global Sourcing Solution
- ✓ Obsolete Management
- ✓ Cost Control Management
- ✓ Shortage Management
- ✓ Alternative Solution
- ✓ Excess Inventory Management