



# THE DATASHEET OF LM9071S/NOPB



## LM9071 Low-Dropout System Voltage Regulator with Delayed Reset

Check for Samples: [LM9071](#)

### FEATURES

- Automotive Application Reliability
- 3% Output Voltage Tolerance
- Insensitive to Radiated RFI
- Dropout Voltage Less than 800 mV with 250 mA Output Current
- Externally Programmed Reset Delay Interval
- Thermal Shutdown
- Short Circuit Protection
- Reverse Battery Protection
- Wide Operating Temperature Range  $-40^{\circ}\text{C}$  to  $+125^{\circ}\text{C}$
- TO-220 and TO-263 Power Surface Mount Power Packages
- Pin for Pin Compatible with the LM2927, L4947 and TLE4260

### DESCRIPTION

The LM9071 is a 5V, 250 mA low-dropout voltage regulator. The regulator features an active low delayed reset output flag which can be used to reset a microprocessor system on turn-ON and in the event that the regulator output falls out of regulation for any reason. An external capacitor programs a delay time interval before the reset output can return high.

Designed for automotive application the LM9071 contains a variety of protection features such as reverse battery, over-voltage shutdown, thermal shutdown, input transient protection and a wide operating temperature range.

Design techniques have been employed to allow the regulator to remain operational and not generate false reset signals when subjected to high levels of RF energy (300V/m from 2 MHz to 400 MHz).

### Typical Application and Connection Diagrams

(Top View)

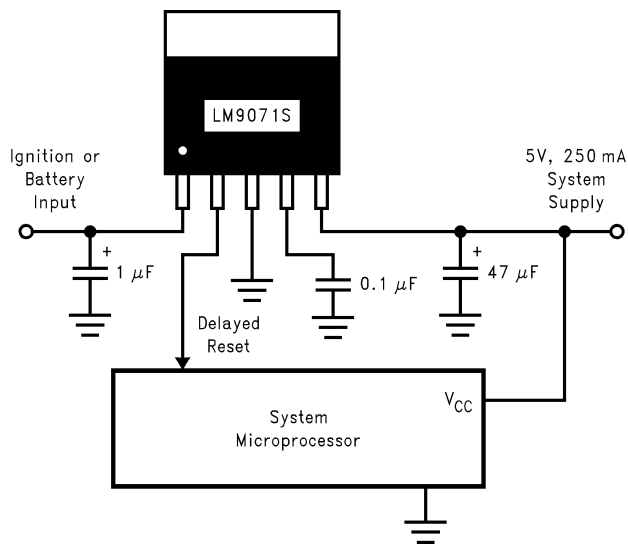
**Figure 1.**

**Figure 2. 5-Lead TO-220 Package  
Package Number KC0005A**

Please be aware that an important notice concerning availability, standard warranty, and use in critical applications of Texas Instruments semiconductor products and disclaimers thereto appears at the end of this data sheet.

All trademarks are the property of their respective owners.

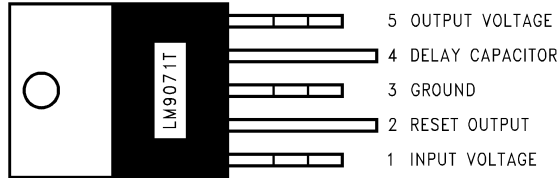

**Figure 3. 5-Lead TO-220 Package  
Package Number NDH0005D**

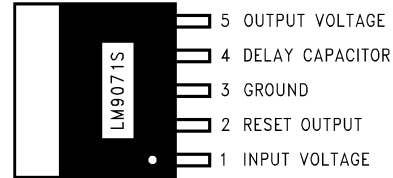

Tab and Backside metal on all packages internally connected to ground.

**Figure 4. 5-Lead TO-263 Surface Mount Package  
Package Number KTT0005B**



These devices have limited built-in ESD protection. The leads should be shorted together or the device placed in conductive foam during storage or handling to prevent electrostatic damage to the MOS gates.

### Absolute Maximum Ratings <sup>(1)</sup>

DC Input Voltage	-26V to +40V
Positive Input Transient (t<100 ms)	60V
Negative Input Transient (t<1 ms)	-50V
Reset Output Sink Current	5 mA
Power Dissipation	Internally Limited
Junction Temperature	150°C
ESD Susceptibility <sup>(2)</sup>	12 kV, 2 kV
Lead Temperature (Soldering, 10 seconds)	260°C
Storage Temperature	-50°C to +150°C

- (1) Absolute Maximum Ratings indicate limits beyond which damage to the device may occur. Operating Ratings indicate conditions for which the device is intended to be functional, but do not ensure specific performance limits. For ensured specifications and conditions, see the Electrical Characteristics.
- (2) All pins will survive an ESD impulse of  $\pm 2000V$  using the human body model of 100 pF discharged through a 1.5 k $\Omega$  resistor. In addition the input voltage pin will withstand ten pulses of  $\pm 12$  kV from a 150 pF capacitor discharged through a 560 $\Omega$  resistor when bypassed with a 22 nF, 100V capacitor.

### Operating Ratings <sup>(1)</sup>

Input Voltage	6V to 26V
Ambient Temperature	-40°C to +125°C
TO-220 Thermal Resistance, $\theta_{J-C}$	3°C/W
TO-220 Thermal Resistance, $\theta_{J-A}$ <sup>(2)</sup>	73°C/W
TO-263 Thermal Resistance, $\theta_{J-C}$	3°C/W
TO-263 Thermal Resistance, $\theta_{J-A}$ <sup>(3)</sup>	80°C/W

- (1) Absolute Maximum Ratings indicate limits beyond which damage to the device may occur. Operating Ratings indicate conditions for which the device is intended to be functional, but do not ensure specific performance limits. For ensured specifications and conditions, see the Electrical Characteristics.
- (2) Exceeding the Maximum Allowable power dissipation will cause excessive die temperature, and the device will go into thermal shutdown. The  $\theta_{J-A}$  value for the TO-220 package (still air, no additional heat sink) is 73°C/W. The effective  $\theta_{J-A}$  value of the TO-220 package can be reduced by using conventional heat sink methods.
- (3) Exceeding the Maximum Allowable power dissipation will cause excessive die temperature, and the device will go into thermal shutdown. The  $\theta_{J-A}$  value for the TO-263 package (still air, no additional heat sink) is 80°C/W. The effective  $\theta_{J-A}$  value of the TO-263 package can be reduced by increasing the printed circuit board area that is connected (soldered) to the package tab. Using 1 ounce (1.4 mils thick) copper clad with no solder mask, an area of 0.5 square inches will reduce  $\theta_{J-A}$  to 50°C/W, an area of 1.0 square inches will reduce  $\theta_{J-A}$  to 37°C/W, and an area of 1.6 square inches will reduce  $\theta_{J-A}$  to 32°C/W. If the printed circuit board uses a solder mask, the copper clad area should be increased by at least 50% to maintain a similar  $\theta_{J-A}$  rating.

## Electrical Characteristics <sup>(1)</sup>

The following specifications apply for  $V_{CC} = 6V$  to  $26V$ ,  $-40^{\circ}C \leq T_A \leq +125^{\circ}C$ , unless otherwise specified.  $C_{OUT} = 47\mu F$  with an  $ESR < 3\Omega$ .  $C_{IN} = 1\mu F$ .

Symbol	Parameter	Conditions	Min	Max	Units
<b>REGULATOR OUTPUT</b>					
$V_{OUT}$	Output Voltage	$5\text{ mA} \leq I_{OUT} \leq 250\text{ mA}$	4.85	5.15	V
$\Delta V_{OUT}$ Line	Line Regulation	$I_{OUT} = 5\text{ mA}$ , $9V \leq V_{IN} \leq 16.5V$		25	mV
		$I_{OUT} = 250\text{ mA}$		50	mV
$\Delta V_{OUT}$ Load	Load Regulation	$V_{IN} = 14.4V$ , $5\text{ mA} \leq I_{OUT} \leq 250\text{ mA}$		60	mV
$I_q$	Quiescent Current	$I_{OUT} = 5\text{ mA}$		4	mA
		$I_{OUT} = 250\text{ mA}$ , $V_{IN} \geq 8V$		25	mA
		$I_{OUT} = 5\text{ mA}$ , $V_{IN} = 5V$		10	mA
		$I_{OUT} = 250\text{ mA}$ , $V_{IN} = 6V$		50	mA
$V_{do}$	Dropout Voltage	$I_{OUT} = 5\text{ mA}$		300	mV
		$I_{OUT} = 250\text{ mA}$		800	mV
$I_{sc}$	Short Circuit Current	$R_L = 1\Omega$	0.35	1.5	A
PSRR	Ripple Rejection	$V_{IN} = (14V_{DC}) + (1V_{RMS} @ 120Hz)$ $I_{OUT} = 50\text{ mA}$	60		dB
OVthr	Overvoltage Shutdown Threshold		27		V
$V_O$ Transient	$V_{OUT}$ during Transients	$V_{IN}$ Peak $\leq 60V$ , $R_L = 100\Omega$ , $\tau = 100\text{ ms}$		7	V
$V_O$ Rev Batt	$V_{OUT}$ during Reverse Battery	$V_{IN} = -15V$	-0.8	0.0	V
<b>RESET OUTPUT</b>					
$V_{th}$	Threshold Voltage	$\Delta V_{OUT}$ Required to Generate a Reset Output $4.8V \leq V_{OUT} \leq 5.2V$	-300	-500	mV
$V_{low}$	Reset Output Low Voltage	$I_{sink} = 1.6\text{ mA}$ , $V_{OUT} > 3.2V$		0.4	V
		$1.4V \leq V_{OUT} \leq 3.2V$		0.8	V
$V_{high}$	Reset Output High Voltage		$0.8 V_{OUT}$		V
$t_{DELAY}$	Delay Time	$C_{DELAY} = 0.1\mu F$	7.6	35	ms
$I_{DELAY}$	Charging Current for $C_{DELAY}$		10	30	$\mu A$
$R_{pu}$	Internal Pull-up Resistance		12	80	k $\Omega$

(1) Datasheet min/max specifications are ensured by design, test, and/or statistical analysis.

### Typical Performance Characteristics

( $T_A = 25^\circ\text{C}$  unless indicated otherwise)

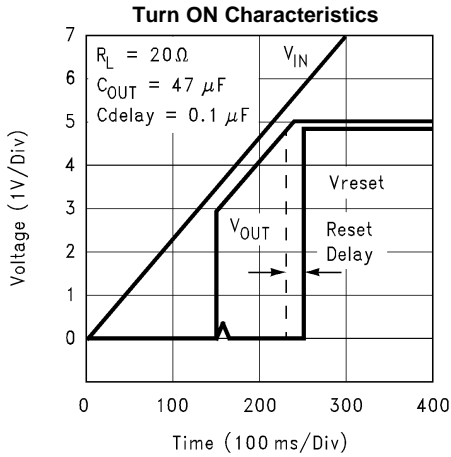

Figure 5.

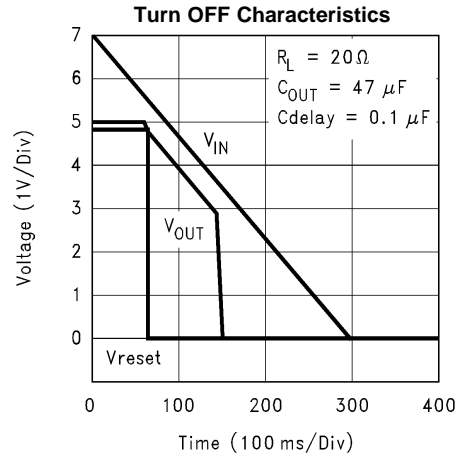

Figure 6.

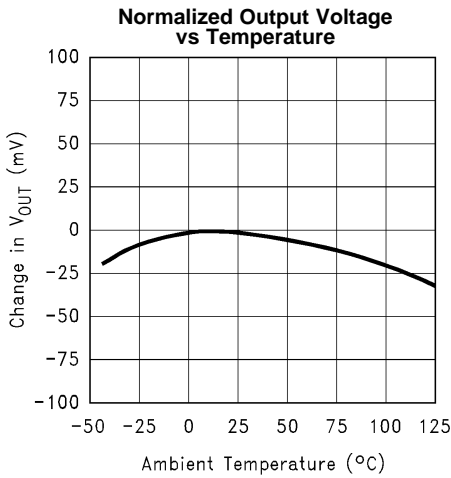

Figure 7.

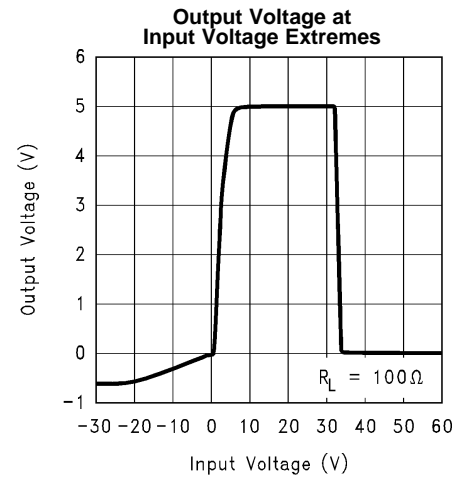

Figure 8.

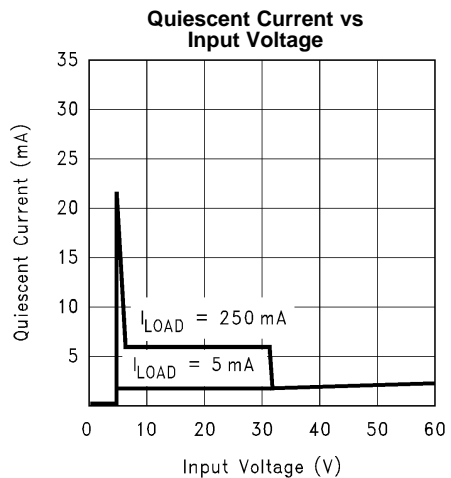

Figure 9.

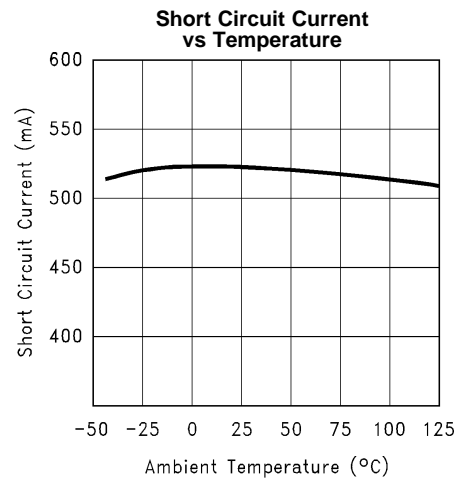

Figure 10.

Typical Performance Characteristics (continued)

(T<sub>A</sub> = 25°C unless indicated otherwise)

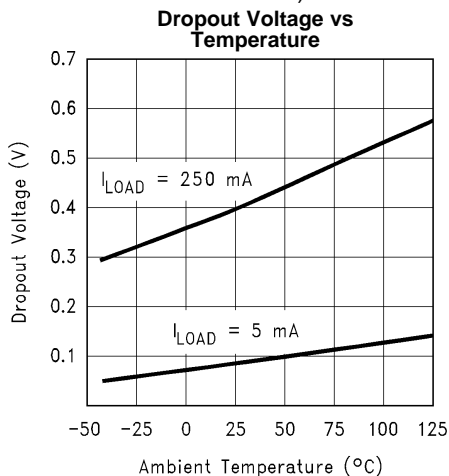

Figure 11.

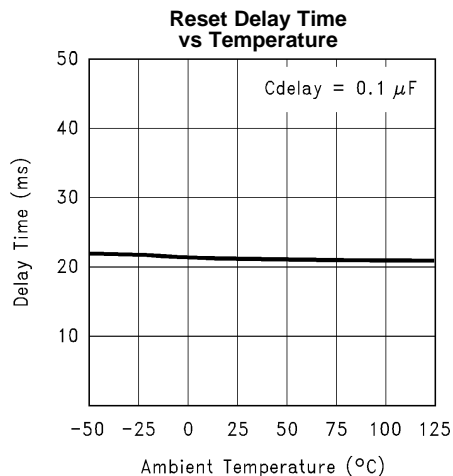

Figure 12.

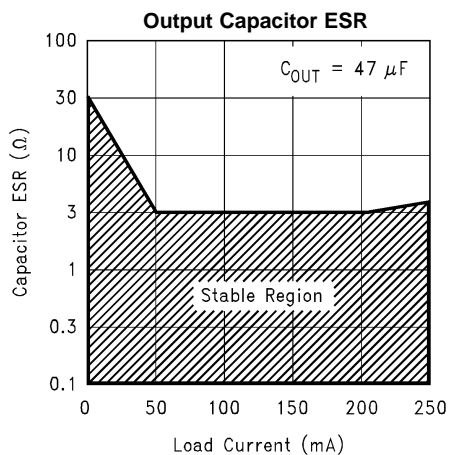

Figure 13.

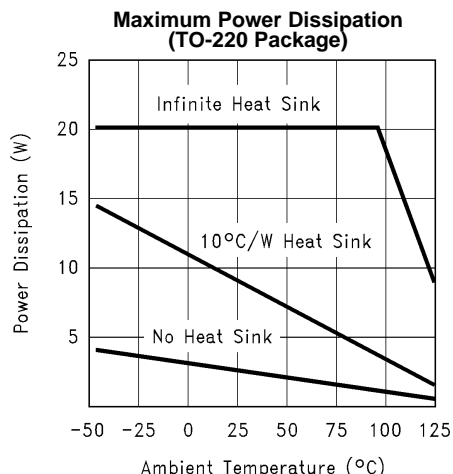

Figure 14.

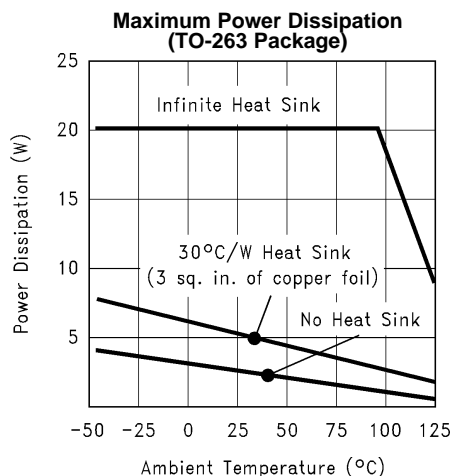
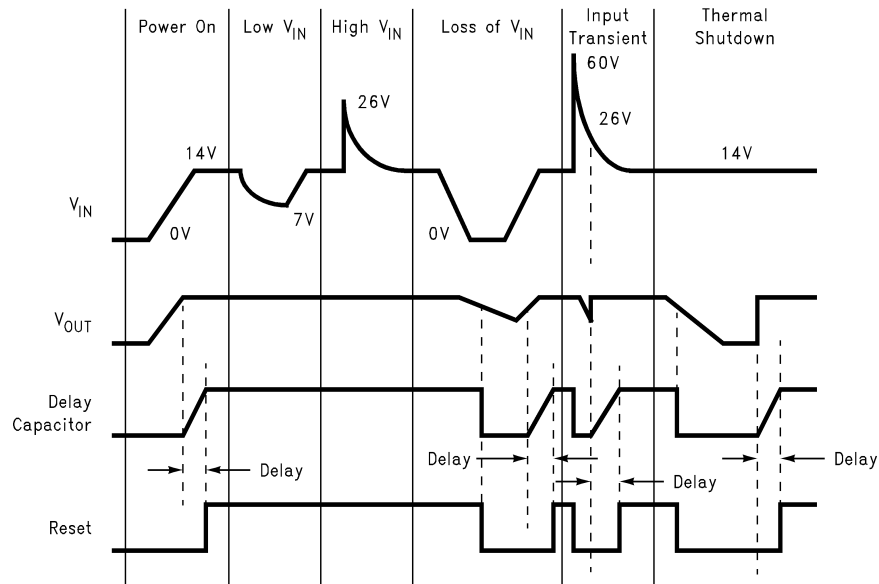
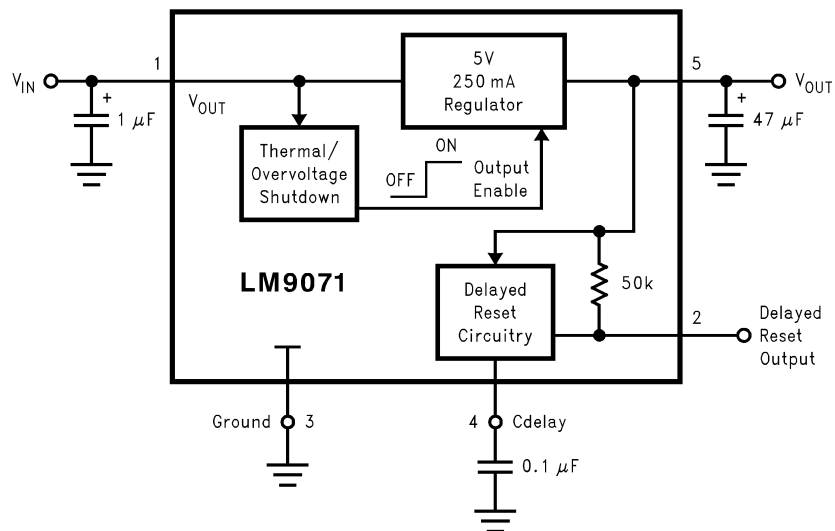

Figure 15.

### Reset Operation and Protection Features



### Block Diagram



### APPLICATION HINTS

The LM9071 voltage regulator has been optimized for use in microprocessor based automotive systems. Several unique design features have been incorporated to address many FMEA (Failure Mode Effects Analysis) concerns for fail-safe system performance.

### FAULT TOLERANT FEATURES

While not specifically ensured due to production testing limitations, the LM9071 has been tested and shown to continue to provide a regulated output and, not generate an erroneous system reset signal while subjected to high levels of RF electric field energy (up to 300 V/m signal strength over a 2 MHz to 400 MHz frequency range). This is very important in vehicle safety related applications where the system must continue to operate normally. To maintain this immunity to RFI the output bypass capacitor is important (47  $\mu\text{F}$  is recommended).

An output bypass capacitor of at least 10  $\mu\text{F}$  is required for stability (47  $\mu\text{F}$  is recommended). The ESR of this capacitor should be less than  $3\Omega$ . An input capacitor of 1  $\mu\text{F}$  or larger is recommended to improve line transient and noise performance.

Conventional load dump protection is built in to withstand up to +60V and –50V transients. Protection against reverse polarity battery connections is also built in. With a reversed battery connection the output of the LM9071 will not go more negative than one diode drop below ground. This will prevent damage to any of the 5V load circuits.

## RESET FLAG

Excessive loading of the output to the point where the output voltage drops by 300 mV to 500 mV will signal a reset flag to the micro. This will warn of a  $V_{\text{CC}}$  supply that may produce unpredictable operation of the system. On power-up and recovery from a fault condition the delay capacitor is used to hold the micro in a reset condition for a programmable time interval to allow the system operating voltages and clock to stabilize before executing code. The delay time interval can be estimated by the following equation:

$$t_{\text{DELAY}} = \frac{3.8\text{V} \times C_{\text{DELAY}}}{20 \mu\text{A}} \quad (1)$$

## INPUT STABILITY

Low dropout voltage regulators which utilize a PNP power transistor usually exhibit a large increase in current when in dropout ( $V_{\text{IN}} < 5.5\text{V}$ ). This increase is caused by the saturation characteristics ( $\beta$  reduction) of the PNP transistor. To significantly minimize this increase in current the LM9071 detects when the PNP enters saturation and reduces the operating current.

This reduction in input current can create a stability problem in applications with higher load current ( $> 100 \text{ mA}$ ) where the input voltage is applied through a long length of wire, which in effect adds a significant amount of inductance in series with the input. The drop in input current may create a positive input voltage transient which may take the PNP out of saturation. If the input voltage is held constant at the threshold where the PNP is going in and out of saturation, an oscillation may be created.

This is only observed where a large series inductance is present in the input supply line and when the rise and fall time of the input supply is very slow. If the application and removal of the input voltage changes at a rate greater than  $500 \text{ mV}/\mu\text{s}$  it will move through the dropout region of the regulator ( $V_{\text{IN}}$  of 3V to 5.5V) too quickly for an oscillation to be established.

## THERMAL MANAGEMENT

The LM9071 is packaged in both a TO-263 surface mount power package and a narrow lead-pitch TO-220 package. To obtain operation over the highest possible load current and input voltage ranges, care must be taken to control the operating temperature of the device. Thermal shutdown protection is built in, with a threshold above  $150^\circ\text{C}$ . Conventional heat-sinking techniques can be used with the TO-220 package. When applying the TO-263 package, on board heat-sinking is important to prevent premature thermal shutdown. More copper foil area under the tab of the device will directly improve the operating  $\theta_{\text{J-A}}$  of the TO-263 package, which will reduce the junction temperature of the device.

The  $\theta_{\text{J-A}}$  value for the TO-263 package (still air, no additional heat sink) is rated at  $80^\circ\text{C}/\text{W}$ . The effective  $\theta_{\text{J-A}}$  value of the TO-263 package can be reduced by increasing the printed circuit board area that is connected (soldered) to the package tab. Using 1 ounce (1.4 mils thick) copper clad with no solder mask, an area of 0.5 square inches will reduce  $\theta_{\text{J-A}}$  to  $50^\circ\text{C}/\text{W}$ , an area of 1.0 square inches will reduce  $\theta_{\text{J-A}}$  to  $37^\circ\text{C}/\text{W}$ , and an area of 1.6 square inches will reduce  $\theta_{\text{J-A}}$  to  $32^\circ\text{C}/\text{W}$ . If the printed circuit board uses a solder mask, the copper clad area under the solder mask should be increased by at least 50% to maintain a similar  $\theta_{\text{J-A}}$  rating.

The use of a double sided PC board with soldered filled vias between two planes of copper, as shown in [Figure 16](#), will improve thermal performance while optimizing the PC board surface area required. Using the double sided PC board arrangement shown in [Figure 16](#), with 1 ounce (1.4 mils thick) copper clad with no solder mask and solder filled vias, an area of 0.5 square inches on both sides will reduce  $\theta_{\text{J-A}}$  to  $43^\circ\text{C}/\text{W}$ .

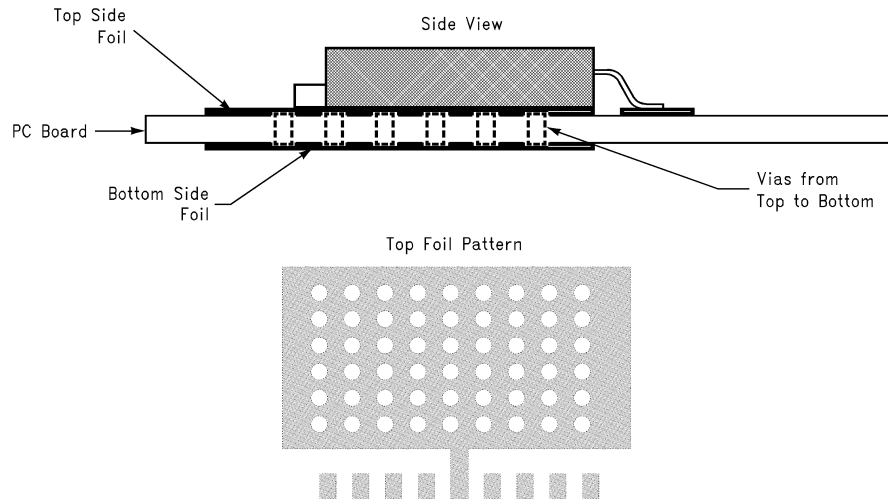

Figure 16. Typical TO-263 PC Board Heatsinking

---

**REVISION HISTORY**

<b>Changes from Revision C (April 2013) to Revision D</b>	<b>Page</b>
<hr/> <ul style="list-style-type: none"><li>• Changed layout of National Data Sheet to TI format .....</li></ul>	<hr/> <b>8</b>

**PACKAGING INFORMATION**

Orderable Device	Status (1)	Package Type	Package Drawing	Pins	Package Qty	Eco Plan (2)	Lead/Ball Finish (6)	MSL Peak Temp (3)	Op Temp (°C)	Device Marking (4/5)	Samples
LM9071S/NOPB	ACTIVE	DDPAK/ TO-263	KTT	5	45	Pb-Free (RoHS Exempt)	CU SN	Level-3-245C-168 HR	-40 to 125	LM9071S	<a href="#">Samples</a>
LM9071SX/NOPB	ACTIVE	DDPAK/ TO-263	KTT	5	500	Pb-Free (RoHS Exempt)	CU SN	Level-3-245C-168 HR	-40 to 125	LM9071S	<a href="#">Samples</a>

(1) The marketing status values are defined as follows:

**ACTIVE:** Product device recommended for new designs.

**LIFEBUY:** TI has announced that the device will be discontinued, and a lifetime-buy period is in effect.

**NRND:** Not recommended for new designs. Device is in production to support existing customers, but TI does not recommend using this part in a new design.

**PREVIEW:** Device has been announced but is not in production. Samples may or may not be available.

**OBSOLETE:** TI has discontinued the production of the device.

(2) Eco Plan - The planned eco-friendly classification: Pb-Free (RoHS), Pb-Free (RoHS Exempt), or Green (RoHS & no Sb/Br) - please check <http://www.ti.com/productcontent> for the latest availability information and additional product content details.

**TBD:** The Pb-Free/Green conversion plan has not been defined.

**Pb-Free (RoHS):** TI's terms "Lead-Free" or "Pb-Free" mean semiconductor products that are compatible with the current RoHS requirements for all 6 substances, including the requirement that lead not exceed 0.1% by weight in homogeneous materials. Where designed to be soldered at high temperatures, TI Pb-Free products are suitable for use in specified lead-free processes.

**Pb-Free (RoHS Exempt):** This component has a RoHS exemption for either 1) lead-based flip-chip solder bumps used between the die and package, or 2) lead-based die adhesive used between the die and leadframe. The component is otherwise considered Pb-Free (RoHS compatible) as defined above.

**Green (RoHS & no Sb/Br):** TI defines "Green" to mean Pb-Free (RoHS compatible), and free of Bromine (Br) and Antimony (Sb) based flame retardants (Br or Sb do not exceed 0.1% by weight in homogeneous material)

(3) MSL, Peak Temp. - The Moisture Sensitivity Level rating according to the JEDEC industry standard classifications, and peak solder temperature.

(4) There may be additional marking, which relates to the logo, the lot trace code information, or the environmental category on the device.

(5) Multiple Device Markings will be inside parentheses. Only one Device Marking contained in parentheses and separated by a "~" will appear on a device. If a line is indented then it is a continuation of the previous line and the two combined represent the entire Device Marking for that device.

(6) Lead/Ball Finish - Orderable Devices may have multiple material finish options. Finish options are separated by a vertical ruled line. Lead/Ball Finish values may wrap to two lines if the finish value exceeds the maximum column width.

**Important Information and Disclaimer:** The information provided on this page represents TI's knowledge and belief as of the date that it is provided. TI bases its knowledge and belief on information provided by third parties, and makes no representation or warranty as to the accuracy of such information. Efforts are underway to better integrate information from third parties. TI has taken and continues to take reasonable steps to provide representative and accurate information but may not have conducted destructive testing or chemical analysis on incoming materials and chemicals. TI and TI suppliers consider certain information to be proprietary, and thus CAS numbers and other limited information may not be available for release.

In no event shall TI's liability arising out of such information exceed the total purchase price of the TI part(s) at issue in this document sold by TI to Customer on an annual basis.

## TAPE AND REEL INFORMATION



### QUADRANT ASSIGNMENTS FOR PIN 1 ORIENTATION IN TAPE



\*All dimensions are nominal

Device	Package Type	Package Drawing	Pins	SPQ	Reel Diameter (mm)	Reel Width W1 (mm)	A0 (mm)	B0 (mm)	K0 (mm)	P1 (mm)	W (mm)	Pin1 Quadrant
LM9071SX/NOPB	DDPAK/ TO-263	KTT	5	500	330.0	24.4	10.75	14.85	5.0	16.0	24.0	Q2

TAPE AND REEL BOX DIMENSIONS



\*All dimensions are nominal

Device	Package Type	Package Drawing	Pins	SPQ	Length (mm)	Width (mm)	Height (mm)
LM9071SX/NOPB	DDPAK/TO-263	KTT	5	500	367.0	367.0	45.0

KTT0005B

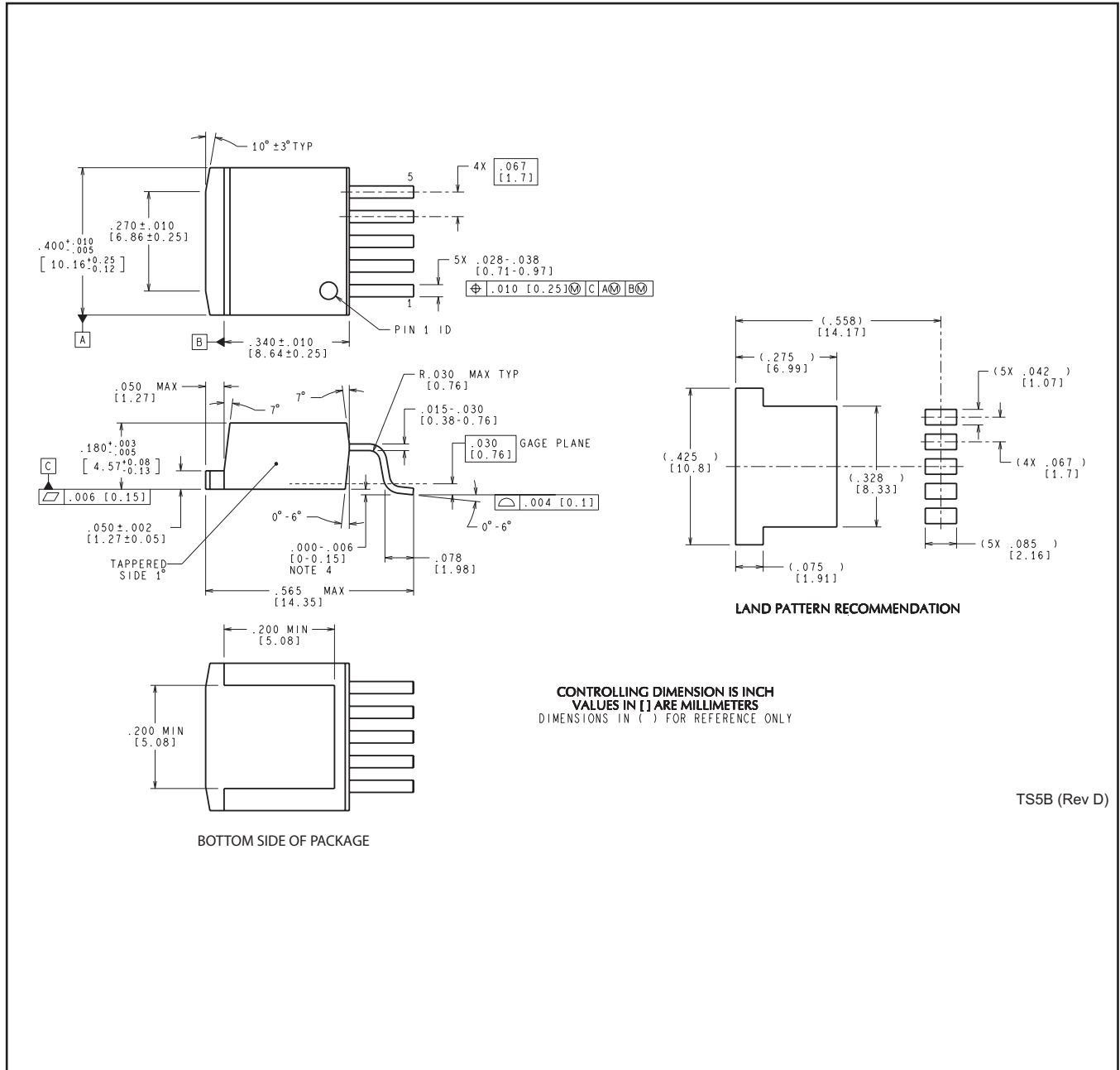

## IMPORTANT NOTICE

Texas Instruments Incorporated (TI) reserves the right to make corrections, enhancements, improvements and other changes to its semiconductor products and services per JESD46, latest issue, and to discontinue any product or service per JESD48, latest issue. Buyers should obtain the latest relevant information before placing orders and should verify that such information is current and complete.

TI's published terms of sale for semiconductor products (<http://www.ti.com/sc/docs/stdterms.htm>) apply to the sale of packaged integrated circuit products that TI has qualified and released to market. Additional terms may apply to the use or sale of other types of TI products and services.

Reproduction of significant portions of TI information in TI data sheets is permissible only if reproduction is without alteration and is accompanied by all associated warranties, conditions, limitations, and notices. TI is not responsible or liable for such reproduced documentation. Information of third parties may be subject to additional restrictions. Resale of TI products or services with statements different from or beyond the parameters stated by TI for that product or service voids all express and any implied warranties for the associated TI product or service and is an unfair and deceptive business practice. TI is not responsible or liable for any such statements.

Buyers and others who are developing systems that incorporate TI products (collectively, "Designers") understand and agree that Designers remain responsible for using their independent analysis, evaluation and judgment in designing their applications and that Designers have full and exclusive responsibility to assure the safety of Designers' applications and compliance of their applications (and of all TI products used in or for Designers' applications) with all applicable regulations, laws and other applicable requirements. Designer represents that, with respect to their applications, Designer has all the necessary expertise to create and implement safeguards that (1) anticipate dangerous consequences of failures, (2) monitor failures and their consequences, and (3) lessen the likelihood of failures that might cause harm and take appropriate actions. Designer agrees that prior to using or distributing any applications that include TI products, Designer will thoroughly test such applications and the functionality of such TI products as used in such applications.

TI's provision of technical, application or other design advice, quality characterization, reliability data or other services or information, including, but not limited to, reference designs and materials relating to evaluation modules, (collectively, "TI Resources") are intended to assist designers who are developing applications that incorporate TI products; by downloading, accessing or using TI Resources in any way, Designer (individually or, if Designer is acting on behalf of a company, Designer's company) agrees to use any particular TI Resource solely for this purpose and subject to the terms of this Notice.

TI's provision of TI Resources does not expand or otherwise alter TI's applicable published warranties or warranty disclaimers for TI products, and no additional obligations or liabilities arise from TI providing such TI Resources. TI reserves the right to make corrections, enhancements, improvements and other changes to its TI Resources. TI has not conducted any testing other than that specifically described in the published documentation for a particular TI Resource.

Designer is authorized to use, copy and modify any individual TI Resource only in connection with the development of applications that include the TI product(s) identified in such TI Resource. NO OTHER LICENSE, EXPRESS OR IMPLIED, BY ESTOPPEL OR OTHERWISE TO ANY OTHER TI INTELLECTUAL PROPERTY RIGHT, AND NO LICENSE TO ANY TECHNOLOGY OR INTELLECTUAL PROPERTY RIGHT OF TI OR ANY THIRD PARTY IS GRANTED HEREIN, including but not limited to any patent right, copyright, mask work right, or other intellectual property right relating to any combination, machine, or process in which TI products or services are used. Information regarding or referencing third-party products or services does not constitute a license to use such products or services, or a warranty or endorsement thereof. Use of TI Resources may require a license from a third party under the patents or other intellectual property of the third party, or a license from TI under the patents or other intellectual property of TI.

TI RESOURCES ARE PROVIDED "AS IS" AND WITH ALL FAULTS. TI DISCLAIMS ALL OTHER WARRANTIES OR REPRESENTATIONS, EXPRESS OR IMPLIED, REGARDING RESOURCES OR USE THEREOF, INCLUDING BUT NOT LIMITED TO ACCURACY OR COMPLETENESS, TITLE, ANY EPIDEMIC FAILURE WARRANTY AND ANY IMPLIED WARRANTIES OF MERCHANTABILITY, FITNESS FOR A PARTICULAR PURPOSE, AND NON-INFRINGEMENT OF ANY THIRD PARTY INTELLECTUAL PROPERTY RIGHTS. TI SHALL NOT BE LIABLE FOR AND SHALL NOT DEFEND OR INDEMNIFY DESIGNER AGAINST ANY CLAIM, INCLUDING BUT NOT LIMITED TO ANY INFRINGEMENT CLAIM THAT RELATES TO OR IS BASED ON ANY COMBINATION OF PRODUCTS EVEN IF DESCRIBED IN TI RESOURCES OR OTHERWISE. IN NO EVENT SHALL TI BE LIABLE FOR ANY ACTUAL, DIRECT, SPECIAL, COLLATERAL, INDIRECT, PUNITIVE, INCIDENTAL, CONSEQUENTIAL OR EXEMPLARY DAMAGES IN CONNECTION WITH OR ARISING OUT OF TI RESOURCES OR USE THEREOF, AND REGARDLESS OF WHETHER TI HAS BEEN ADVISED OF THE POSSIBILITY OF SUCH DAMAGES.

Unless TI has explicitly designated an individual product as meeting the requirements of a particular industry standard (e.g., ISO/TS 16949 and ISO 26262), TI is not responsible for any failure to meet such industry standard requirements.

Where TI specifically promotes products as facilitating functional safety or as compliant with industry functional safety standards, such products are intended to help enable customers to design and create their own applications that meet applicable functional safety standards and requirements. Using products in an application does not by itself establish any safety features in the application. Designers must ensure compliance with safety-related requirements and standards applicable to their applications. Designer may not use any TI products in life-critical medical equipment unless authorized officers of the parties have executed a special contract specifically governing such use. Life-critical medical equipment is medical equipment where failure of such equipment would cause serious bodily injury or death (e.g., life support, pacemakers, defibrillators, heart pumps, neurostimulators, and implantables). Such equipment includes, without limitation, all medical devices identified by the U.S. Food and Drug Administration as Class III devices and equivalent classifications outside the U.S.

TI may expressly designate certain products as completing a particular qualification (e.g., Q100, Military Grade, or Enhanced Product). Designers agree that it has the necessary expertise to select the product with the appropriate qualification designation for their applications and that proper product selection is at Designers' own risk. Designers are solely responsible for compliance with all legal and regulatory requirements in connection with such selection.

Designer will fully indemnify TI and its representatives against any damages, costs, losses, and/or liabilities arising out of Designer's non-compliance with the terms and provisions of this Notice.

## Looking for pricing, stock, or lifecycle information?

Click below to explore more details on WIN SOURCE:

 [View LM9071S/NOPB on WIN SOURCE](#)

 [Texas Instruments](#) Information

## Optimize Your Supply Chain with WIN SOURCE Solutions

-  Global Sourcing Solution
-  Obsolete Management
-  Cost Control Management
-  Shortage Management
-  Alternative Solution
-  Excess Inventory Management