



**THE DATASHEET OF  
YFF21SC1H102MT000N**





## 3-terminal filters

For signal line

# YFF-SC series

---

<b>YFF15SC</b>	<b>1005 [0402 inch]*</b>	<b>Feed through filter</b>
<b>YFF18SC</b>	<b>1608 [0603 inch]</b>	<b>Feed through filter</b>
<b>YFF21SC</b>	<b>2012 [0805 inch]</b>	<b>Feed through filter</b>

\* Dimensions Code JIS[EIA]

---

## 3-terminal filters

For signal line

Product compatible with RoHS directive  
Compatible with lead-free solders

# Overview of the YFF-SC series

### FEATURES

- Small and high-performance EMC components.
- Good attenuation characteristic in high frequency ranges.

### APPLICATION

High impedance circuits, e.g. digital signal circuits.  
I/O interface sections of devices with electric circuits and the area around connectors.  
Low-current power line of communication terminal devices, AV, and information devices.

### PART NUMBER CONSTRUCTION

Series name		L x W dimensions		Product internal code		Rated voltage		Capacitance		Tolerance		Taping	TDK internal code	Reel size		Internal electrode Ni
Code	mm	Code	mm	Code	V	Code	pF	M	±20%		Code	mm	Code	mm		
YFF	21	SC	Signal line	1E	16	473	22	M	±20%	T		0	ø178	N		
	15	1.0x0.5		1C	16	220	22					9	ø330			
	18	1.6x0.8		1E	25	101	100									
	21	2.0x1.2		1H	50	221	220									
						473	47,000 (47nF)									

### OPERATING TEMPERATURE RANGE, PACKAGE QUANTITY, PRODUCT WEIGHT

Type	Package quantity (piece/reel)		Individual weight (g)
	ø178	ø330	
YFF15SC	10,000	50,000	0.0008
YFF18SC	4,000	10,000	0.0038
YFF21SC	4,000	10,000	0.0095

\* The storage temperature range is for after the assembly.

- Conformity to RoHS directive: this means that, in conformity with EU directive 2011/65/EC, lead, cadmium, mercury, hexavalent chromium, and specific bromine-based flame retardants, PBB and PBDE, have not been used, except for exempted applications.
- Please contact our Sales office when your application is considered the following: The device's failure or malfunction may directly endanger human life (e.g. application for automobile/aircraft/medical/nuclear power devices, etc.)

 Please be sure to request delivery specifications that provide further details on the features and specifications of the products for proper and safe use. Please note that the contents may change without any prior notice due to reasons such as upgrading.

# Overview of the YFF-SC series

## RECOMMENDED SOLDERING CONDITION

### REFLOW SOLDERING

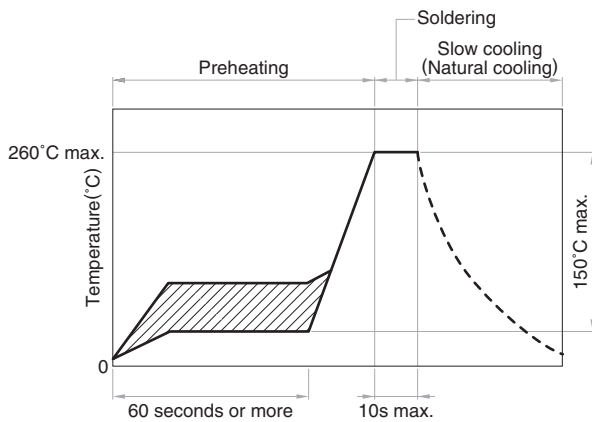

### HAND SOLDERING

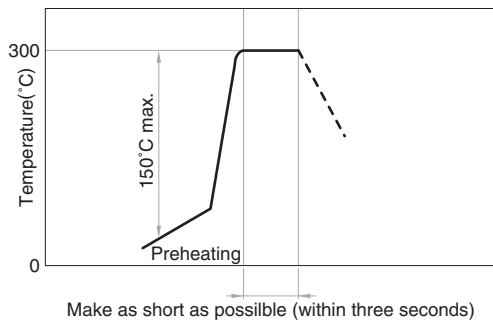

## REMINDERS FOR USING THESE PRODUCTS

- Before soldering, be sure to preheat components. The  $\Delta T$  preheating temperature must be 150°C max. with attention paid to thermal shock.
- Natural cooling of components in the air is recommended. On the other hand, when dipping them in a solvent for purposes, such as cleaning, make sure that the temperature difference ( $\Delta T$ ) is 100°C.
- When performing hand soldering for circuit modification, apply the soldering iron to the copper foil area of the printed circuit board for 3 seconds or less. The temperature of the iron tip should not exceed 300°C.
- Use a wrist band to discharge static electricity in your body through the grounding wire.
- When incorporating the printed circuit board on which this product is mounted into a frame, etc., do not apply stress to the product through local bending of the board by tightening of screws, etc.

# YFF-SC series YFF15SC type (Feed through filter)

## SHAPE & DIMENSIONS

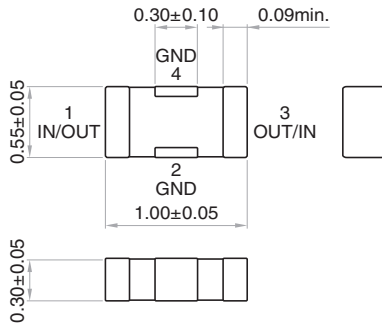

## RECOMMENDED LAND PATTERN

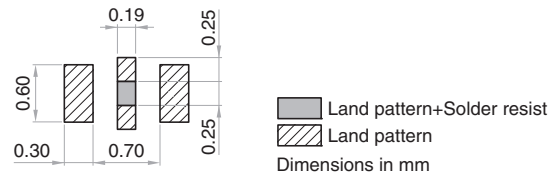

\* Make sure to connect the GND terminal of this product and the GND of the mounting circuit board by using through holes so that the distance between them is the shortest.

## ELECTRICAL CHARACTERISTICS

### CHARACTERISTICS SPECIFICATION TABLE

Cutoff frequency (MHz)	Insertion loss 30dB bandwidth (MHz)	Rated voltage Edc (V)	Rated current Idc (A)	Operating temperature range (°C)	Storage temperature range (After mount) (°C)	Part No.*
0.1	5 to 4000	16	1	-55 to +125	-55 to +125	<a href="#">YFF15SC1C473MT000N</a>
0.1	5 to 4000	16	1	-55 to +125	-55 to +125	<a href="#">YFF15SC1C473MT009N</a>
0.3	10 to 4000	16	1	-55 to +125	-55 to +125	<a href="#">YFF15SC1C223MT000N</a>
0.3	10 to 4000	16	1	-55 to +125	-55 to +125	<a href="#">YFF15SC1C223MT009N</a>
0.6	20 to 4000	25	1	-55 to +125	-55 to +125	<a href="#">YFF15SC1E103MT000N</a>
0.6	20 to 4000	25	1	-55 to +125	-55 to +125	<a href="#">YFF15SC1E103MT009N</a>
1	50 to 4000	25	1	-55 to +125	-55 to +125	<a href="#">YFF15SC1E472MT000N</a>
1	50 to 4000	25	1	-55 to +125	-55 to +125	<a href="#">YFF15SC1E472MT009N</a>
3	100 to 4000	25	1	-55 to +125	-55 to +125	<a href="#">YFF15SC1E222MT000N</a>
3	100 to 4000	25	1	-55 to +125	-55 to +125	<a href="#">YFF15SC1E222MT009N</a>
6	200 to 4000	25	1	-55 to +125	-55 to +125	<a href="#">YFF15SC1E102MT000N</a>
6	200 to 4000	25	1	-55 to +125	-55 to +125	<a href="#">YFF15SC1E102MT009N</a>
10	600 to 4000	25	1	-55 to +125	-55 to +125	<a href="#">YFF15SC1E471MT000N</a>
10	600 to 4000	25	1	-55 to +125	-55 to +125	<a href="#">YFF15SC1E471MT009N</a>
30	800 to 6000	50	1	-55 to +125	-55 to +125	<a href="#">YFF15SC1H221MT000N</a>
30	800 to 6000	50	1	-55 to +125	-55 to +125	<a href="#">YFF15SC1H221MT009N</a>
60	1500 to 6000	50	1	-55 to +125	-55 to +125	<a href="#">YFF15SC1H101MT000N</a>
60	1500 to 6000	50	1	-55 to +125	-55 to +125	<a href="#">YFF15SC1H101MT009N</a>
100	2000 to 6000	50	1	-55 to +125	-55 to +125	<a href="#">YFF15SC1H470MT000N</a>
100	2000 to 6000	50	1	-55 to +125	-55 to +125	<a href="#">YFF15SC1H470MT009N</a>
300	4000 to 6000	50	1	-55 to +125	-55 to +125	<a href="#">YFF15SC1H220MT000N</a>
300	4000 to 6000	50	1	-55 to +125	-55 to +125	<a href="#">YFF15SC1H220MT009N</a>

\* The part numbers are TDK's standard specification products.

# YFF-SC series YFF15SC type (Feed through filter)

- ELECTRICAL CHARACTERISTICS GRAPH (EXAMPLE)
- INSERTION LOSS VS. FREQUENCY CHARACTERISTICS

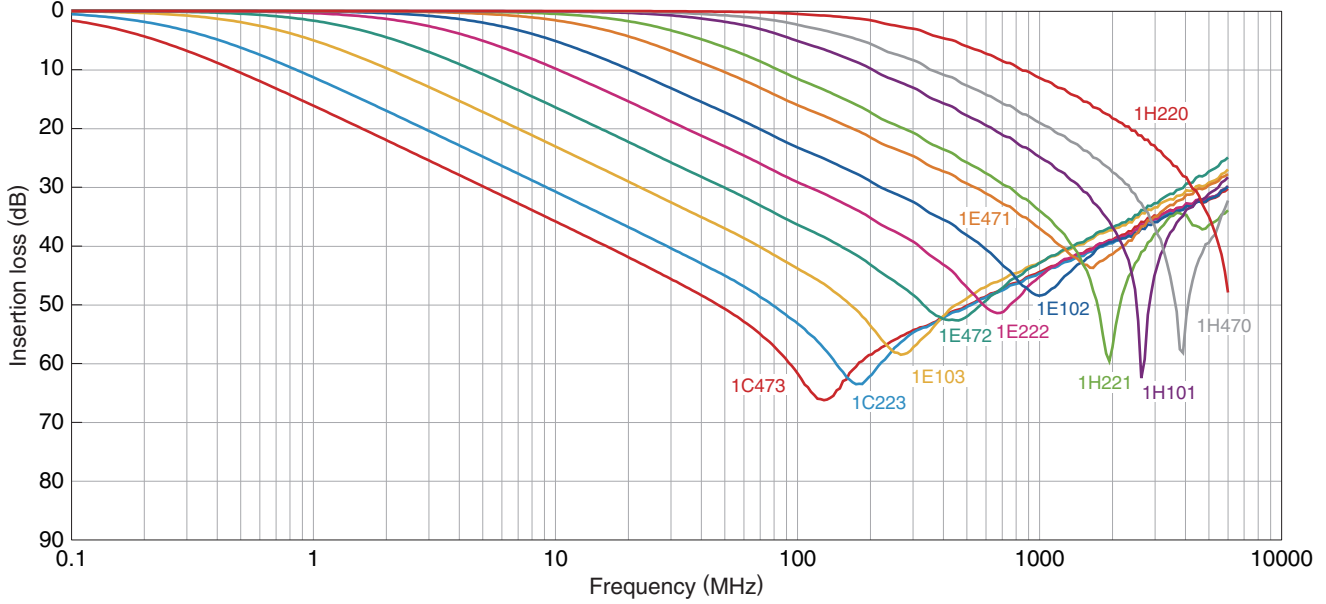

 Please be sure to request delivery specifications that provide further details on the features and specifications of the products for proper and safe use. Please note that the contents may change without any prior notice due to reasons such as upgrading.

# YFF-SC series YFF18SC type (Feed through filter)

## SHAPE & DIMENSIONS

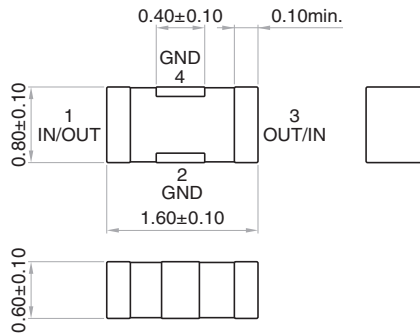

## RECOMMENDED LAND PATTERN

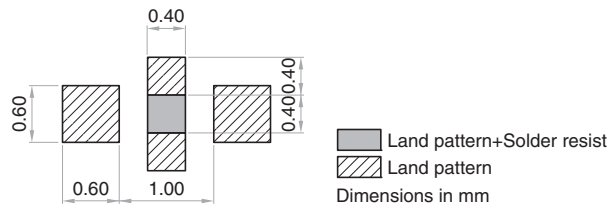

\* Make sure to connect the GND terminal of this product and the GND of the mounting circuit board by using through holes so that the distance between them is the shortest.

## ELECTRICAL CHARACTERISTICS

### CHARACTERISTICS SPECIFICATION TABLE

Cutoff frequency (MHz)	Insertion loss 30dB bandwidth (MHz)	Rated voltage Edc (V)	Rated current Idc (A)	Operating temperature range (°C)	Storage temperature range (After mount) (°C)	Part No.*
0.3	10 to 3000	50	1	-55 to +125	-55 to +125	<a href="#">YFF18SC1H223MT0H0N</a>
0.3	10 to 3000	50	1	-55 to +125	-55 to +125	<a href="#">YFF18SC1H223MT0H9N</a>
0.6	20 to 3000	50	1	-55 to +125	-55 to +125	<a href="#">YFF18SC1H103MT0H0N</a>
0.6	20 to 3000	50	1	-55 to +125	-55 to +125	<a href="#">YFF18SC1H103MT0H9N</a>
1	40 to 3000	50	1	-55 to +125	-55 to +125	<a href="#">YFF18SC1H472MT0H0N</a>
1	40 to 3000	50	1	-55 to +125	-55 to +125	<a href="#">YFF18SC1H472MT0H9N</a>
2	90 to 3000	50	1	-55 to +125	-55 to +125	<a href="#">YFF18SC1H222MT0H0N</a>
2	90 to 3000	50	1	-55 to +125	-55 to +125	<a href="#">YFF18SC1H222MT0H9N</a>
6	200 to 3000	50	1	-55 to +125	-55 to +125	<a href="#">YFF18SC1H102MT0H0N</a>
6	200 to 3000	50	1	-55 to +125	-55 to +125	<a href="#">YFF18SC1H102MT0H9N</a>
10	400 to 6000	50	1	-55 to +125	-55 to +125	<a href="#">YFF18SC1H471MT0H0N</a>
10	400 to 6000	50	1	-55 to +125	-55 to +125	<a href="#">YFF18SC1H471MT0H9N</a>
20	800 to 6000	50	1	-55 to +125	-55 to +125	<a href="#">YFF18SC1H221MT0H0N</a>
20	800 to 6000	50	1	-55 to +125	-55 to +125	<a href="#">YFF18SC1H221MT0H9N</a>
60	1500 to 6000	50	1	-55 to +125	-55 to +125	<a href="#">YFF18SC1H101MT0H0N</a>
60	1500 to 6000	50	1	-55 to +125	-55 to +125	<a href="#">YFF18SC1H101MT0H9N</a>
100	2000 to 6000	50	1	-55 to +125	-55 to +125	<a href="#">YFF18SC1H470MT0H0N</a>
100	2000 to 6000	50	1	-55 to +125	-55 to +125	<a href="#">YFF18SC1H470MT0H9N</a>
200	4000 to 6000	50	1	-55 to +125	-55 to +125	<a href="#">YFF18SC1H220MT0H0N</a>
200	4000 to 6000	50	1	-55 to +125	-55 to +125	<a href="#">YFF18SC1H220MT0H9N</a>

\* The part numbers are TDK's standard specification products.

# YFF-SC series YFF18SC type (Feed through filter)

- ELECTRICAL CHARACTERISTICS GRAPH (EXAMPLE)
- INSERTION LOSS VS. FREQUENCY CHARACTERISTICS

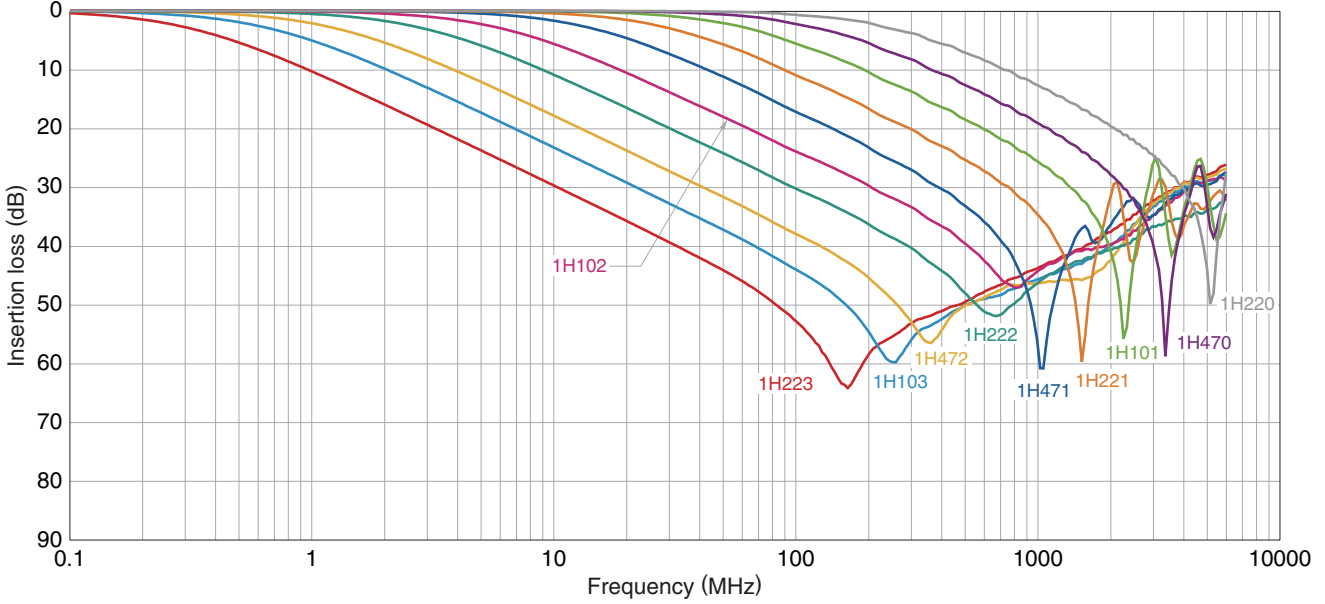

⚠ Please be sure to request delivery specifications that provide further details on the features and specifications of the products for proper and safe use. Please note that the contents may change without any prior notice due to reasons such as upgrading.

# YFF-SC series YFF21SC type (Feed through filter)

## SHAPE & DIMENSIONS

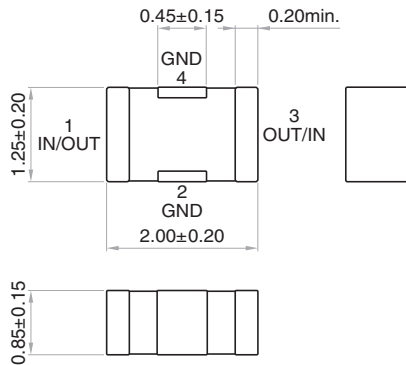

## RECOMMENDED LAND PATTERN

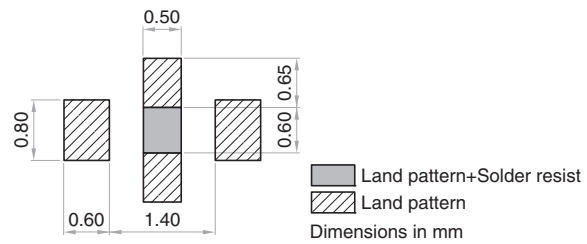

\* Make sure to connect the GND terminal of this product and the GND of the mounting circuit board by using through holes so that the distance between them is the shortest.

## ELECTRICAL CHARACTERISTICS

### CHARACTERISTICS SPECIFICATION TABLE

Cutoff frequency (MHz)	Insertion loss 30dB bandwidth (MHz)	Rated voltage Edc (V)	Rated current Idc (A)	Operating temperature range (°C)	Storage temperature range (After mount) (°C)	Part No.*
0.1	5 to 2000	50	2	-55 to +125	-55 to +125	<a href="#">YFF21SC1H473MT000N</a>
0.1	5 to 2000	50	2	-55 to +125	-55 to +125	<a href="#">YFF21SC1H473MT009N</a>
0.1	5 to 2000	25	2	-55 to +125	-55 to +125	<a href="#">YFF21SC1E473MT000N</a>
0.1	5 to 2000	25	2	-55 to +125	-55 to +125	<a href="#">YFF21SC1E473MT009N</a>
0.2	10 to 2000	50	2	-55 to +125	-55 to +125	<a href="#">YFF21SC1H223MT000N</a>
0.2	10 to 2000	50	2	-55 to +125	-55 to +125	<a href="#">YFF21SC1H223MT009N</a>
0.2	10 to 2000	25	2	-55 to +125	-55 to +125	<a href="#">YFF21SC1E223MT000N</a>
0.2	10 to 2000	25	2	-55 to +125	-55 to +125	<a href="#">YFF21SC1E223MT009N</a>
0.5	20 to 2000	25	1	-55 to +125	-55 to +125	<a href="#">YFF21SC1E103MT000N</a>
0.5	20 to 2000	25	1	-55 to +125	-55 to +125	<a href="#">YFF21SC1E103MT009N</a>
1	40 to 2000	50	0.4	-55 to +125	-55 to +125	<a href="#">YFF21SC1H472MT000N</a>
1	40 to 2000	50	0.4	-55 to +125	-55 to +125	<a href="#">YFF21SC1H472MT009N</a>
2	70 to 2000	50	0.4	-55 to +125	-55 to +125	<a href="#">YFF21SC1H222MT000N</a>
2	70 to 2000	50	0.4	-55 to +125	-55 to +125	<a href="#">YFF21SC1H222MT009N</a>
5	200 to 2000	50	0.4	-55 to +125	-55 to +125	<a href="#">YFF21SC1H102MT000N</a>
5	200 to 2000	50	0.4	-55 to +125	-55 to +125	<a href="#">YFF21SC1H102MT009N</a>
10	400 to 5000	50	0.4	-55 to +125	-55 to +125	<a href="#">YFF21SC1H471MT000N</a>
10	400 to 5000	50	0.4	-55 to +125	-55 to +125	<a href="#">YFF21SC1H471MT009N</a>
20	700 to 5000	50	0.4	-55 to +125	-55 to +125	<a href="#">YFF21SC1H221MT000N</a>
20	700 to 5000	50	0.4	-55 to +125	-55 to +125	<a href="#">YFF21SC1H221MT009N</a>
50	1000 to 5000	50	0.4	-55 to +125	-55 to +125	<a href="#">YFF21SC1H101MT000N</a>
50	1000 to 5000	50	0.4	-55 to +125	-55 to +125	<a href="#">YFF21SC1H101MT009N</a>
100	2000 to 5000	50	0.4	-55 to +125	-55 to +125	<a href="#">YFF21SC1H470MT000N</a>
100	2000 to 5000	50	0.4	-55 to +125	-55 to +125	<a href="#">YFF21SC1H470MT009N</a>
200	3000 to 5000	50	0.4	-55 to +125	-55 to +125	<a href="#">YFF21SC1H220MT000N</a>
200	3000 to 5000	50	0.4	-55 to +125	-55 to +125	<a href="#">YFF21SC1H220MT009N</a>

\* The part numbers are TDK's standard specification products.

Background red: The product which is planning to stop production

Please be sure to request delivery specifications that provide further details on the features and specifications of the products for proper and safe use. Please note that the contents may change without any prior notice due to reasons such as upgrading.

# YFF-SC series YFF21SC type (Feed through filter)

**ELECTRICAL CHARACTERISTICS GRAPH**  
**INSERTION LOSS VS. FREQUENCY CHARACTERISTICS**

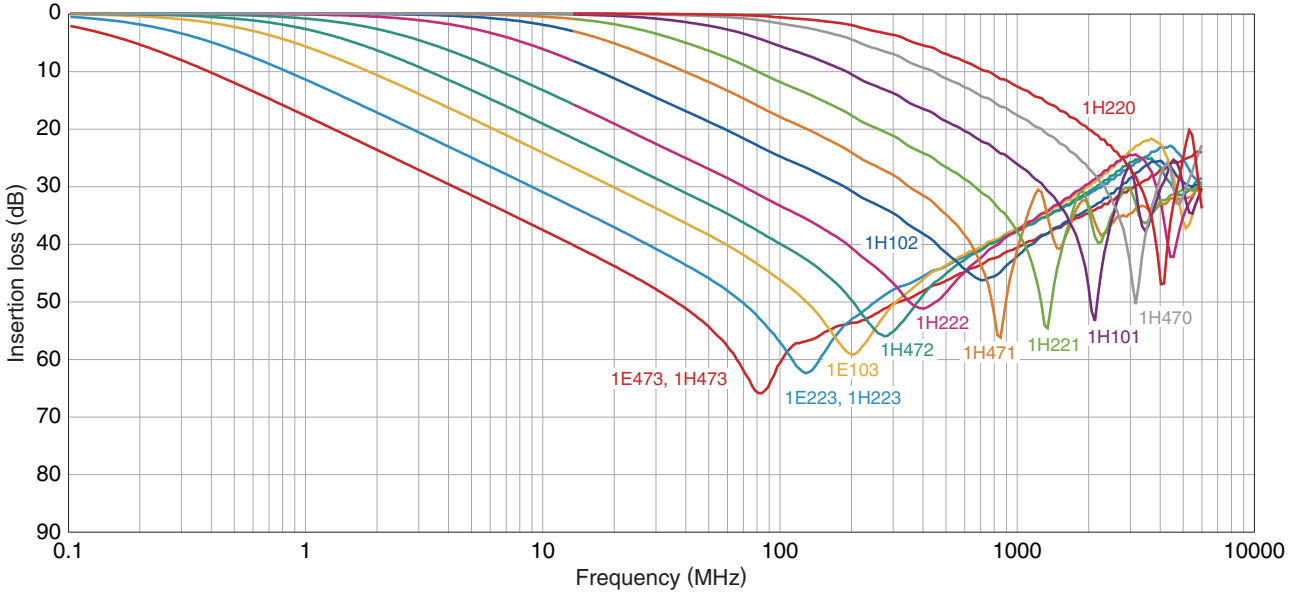

 Please be sure to request delivery specifications that provide further details on the features and specifications of the products for proper and safe use. Please note that the contents may change without any prior notice due to reasons such as upgrading.

# YFF-SC series Packaging style

## REEL DIMENSIONS

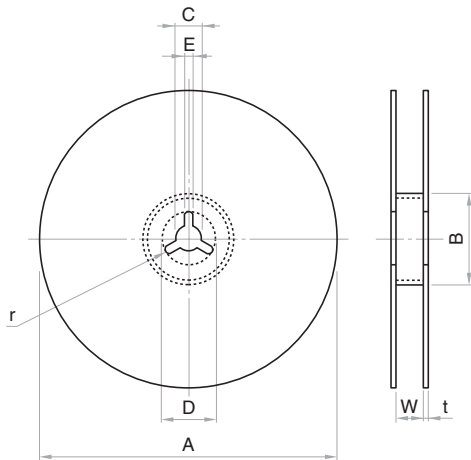

Unit: mm

Reel	A	B	C	D	E	W	t	r
ø178	ø178±2.0	ø60±2.0	ø13±0.5	ø21±0.8	2.0±0.5	9.0±0.3	2.0±0.5	1.0
ø330	ø382 max.(ø330 nom.)	ø50 min.	ø13±0.5	ø21±0.8	2.0±0.5	10.0±1.5	2.0±0.5	1.0

## TAPE DIMENSIONS

### Paper tape

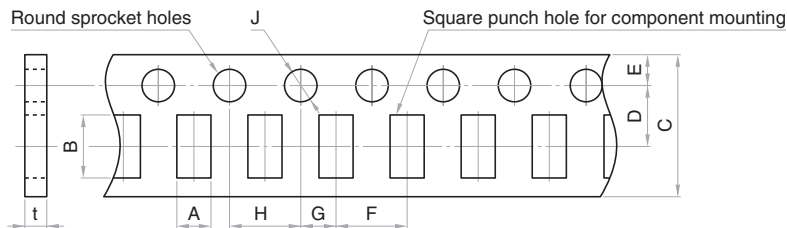



Unit: mm

Type	A	B	C	D	E	F	G	H	J	t
YFF15SC	0.62 typ.	1.12 typ.	8.0±0.3	3.5±0.05	1.75±0.1	2.0±0.05	2.0±0.05	4.0±0.1	ø1.5+0.1/-0	0.7 max.
YFF18SC	1.10 typ.	1.90 typ.	8.0±0.3	3.5±0.05	1.75±0.1	4.0±0.1	2.0±0.05	4.0±0.1	ø1.5+0.1/-0	1.1 max.
YFF21SC	1.50 typ.	2.3 typ.	8.0±0.3	3.5±0.05	1.75±0.1	4.0±0.1	2.0±0.05	4.0±0.1	ø1.5+0.1/-0	1.1 max.

⚠ Please be sure to request delivery specifications that provide further details on the features and specifications of the products for proper and safe use. Please note that the contents may change without any prior notice due to reasons such as upgrading.

## Looking for pricing, stock, or lifecycle information?

Click below to explore more details on WIN SOURCE:

-  [View YFF21SC1H102MT000N on WIN SOURCE](#)
-  [TDK Corporation](#) Information

## Optimize Your Supply Chain with WIN SOURCE Solutions

-  Global Sourcing Solution
-  Obsolete Management
-  Cost Control Management
-  Shortage Management
-  Alternative Solution
-  Excess Inventory Management