



**THE DATASHEET OF  
LM27313XQMFX/NOPB**



## LM27313/-Q1 1.6-MHz Boost Converter With 30-V Internal FET Switch in SOT-23

### 1 Features

- LM27313-Q1 is an Automotive-Grade Product that is AEC-Q100 Grade 1 Qualified ( $-40^{\circ}\text{C}$  to  $+125^{\circ}\text{C}$  Operating Junction Temperature)
- 30-V DMOS FET Switch
- 1.6-MHz Switching Frequency
- Low  $R_{\text{DS(ON)}}$  DMOS FET
- Switch Current up to 800 mA
- Wide Input Voltage Range (2.7 V to 14 V)
- Low Shutdown Current ( $< 1 \mu\text{A}$ )
- 5-Lead SOT-23 Package
- Uses Tiny Capacitors and Inductors
- Cycle-by-Cycle Current Limiting
- Internally Compensated

### 2 Applications

- White LED Current Source
- PDAs and Palm-Top Computers
- Digital Cameras
- Portable Phones, Games, and Media Players
- GPS Devices

### 3 Description

The LM27313/-Q1 switching regulator is a current-mode boost converter with a fixed operating frequency of 1.6 MHz.

The use of the SOT-23 package, made possible by the minimal losses of the 800-mA switch, and the small inductors and capacitors result in extremely high power density. The 30-V internal switch makes these solutions perfect for boosting to voltages of 5 V to 28 V.

This device has a logic-level shutdown pin that can be used to reduce quiescent current and extend battery life.

Protection is provided through cycle-by-cycle current limiting and thermal shutdown. Internal compensation simplifies design and reduces component count.

#### Device Information<sup>(1)</sup>

| PART NUMBER | PACKAGE    | BODY SIZE (NOM)   |
|-------------|------------|-------------------|
| LM27313     | SOT-23 (5) | 2.90 mm x 1.60 mm |
| LM27313-Q1  |            |                   |

(1) For all available packages, see the orderable addendum at the end of the data sheet.

#### Typical Application Circuit

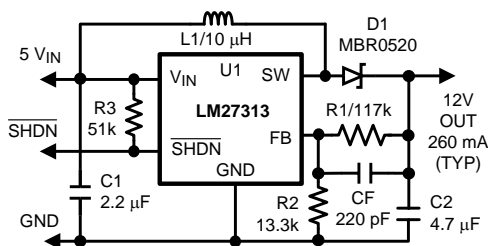

#### Efficiency vs. Load Current

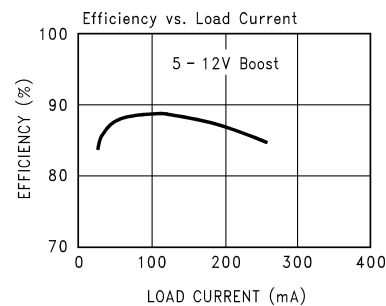

## Table of Contents

|  |  |
|--|--|
| <b>1 Features</b> ..... 1<br><b>2 Applications</b> ..... 1<br><b>3 Description</b> ..... 1<br><b>4 Revision History</b> ..... 2<br><b>5 Pin Configuration and Functions</b> ..... 3<br><b>6 Specifications</b> ..... 3<br>6.1 Absolute Maximum Ratings ..... 3<br>6.2 ESD Ratings: LM27313 ..... 3<br>6.3 ESD Ratings: LM27313-Q1 ..... 4<br>6.4 Recommended Operating Conditions ..... 4<br>6.5 Thermal Information ..... 4<br>6.6 Electrical Characteristics ..... 5<br>6.7 Typical Characteristics ..... 6<br><b>7 Detailed Description</b> ..... 8<br>7.1 Overview ..... 8<br>7.2 Functional Block Diagram ..... 8<br>7.3 Feature Description..... 8 | 7.4 Device Functional Modes..... 9<br><b>8 Application and Implementation</b> ..... 10<br>8.1 Application Information..... 10<br>8.2 Typical Applications ..... 10<br><b>9 Power Supply Recommendations</b> ..... 17<br><b>10 Layout</b> ..... 17<br>10.1 Layout Guidelines ..... 17<br>10.2 Layout Example ..... 17<br>10.3 Thermal Considerations ..... 17<br><b>11 Device and Documentation Support</b> ..... 18<br>11.1 Device Support..... 18<br>11.2 Related Links ..... 18<br>11.3 Trademarks ..... 18<br>11.4 Electrostatic Discharge Caution..... 18<br>11.5 Glossary ..... 18<br><b>12 Mechanical, Packaging, and Orderable Information</b> ..... 18 |
|--|--|

## 4 Revision History

| Changes from Revision D (April 2013) to Revision E  | Page |
|---|------|
| <ul style="list-style-type: none"> <li>• Added <i>Pin Configuration and Functions</i> section, <i>ESD Ratings</i> table, <i>Feature Description</i> section, <i>Device Functional Modes</i>, <i>Application and Implementation</i> section, <i>Power Supply Recommendations</i> section, <i>Layout</i> section, <i>Device and Documentation Support</i> section, and <i>Mechanical, Packaging, and Orderable Information</i> section ..... 1</li> </ul> | 1    |
|   |      |
| Changes from Revision C (April 2013) to Revision D  | Page |
| <ul style="list-style-type: none"> <li>• Changed layout of National Data Sheet to TI format ..... 15</li> </ul>   | 15   |

## 5 Pin Configuration and Functions

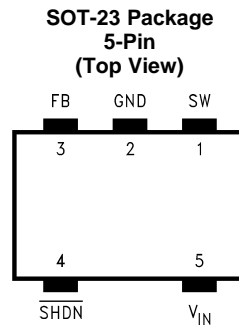

| PIN |                          | I/O <sup>(1)</sup> | DESCRIPTION   |
|-----|--------------------------|--------------------|---|
| NO. | NAME                     |                    |   |
| 1   | SW                       | O                  | Drain of the internal FET switch.   |
| 2   | GND                      | G                  | Analog and power ground.  |
| 3   | FB                       | I                  | Feedback point that connects to external resistive divider to set $V_{OUT}$ . |
| 4   | $\overline{\text{SHDN}}$ | I                  | Shutdown control input. Connect to $V_{IN}$ if this feature is not used.      |
| 5   | $V_{IN}$                 | I/P                | Analog and power input.   |

(1) I: Input Pin, O: Output Pin, P: Power Pin, G: Ground Pin

## 6 Specifications

### 6.1 Absolute Maximum Ratings<sup>(1)(2)</sup>

|                                   | MIN                | MAX  | UNIT |
|-----------------------------------|--------------------|------|------|
| FB Pin Voltage                    | -0.4               | 6    | V    |
| SW Pin Voltage                    | -0.4               | 30   | V    |
| Input Supply Voltage              | -0.4               | 14.5 | V    |
| Shutdown Input Voltage (Survival) | -0.4               | 14.5 | V    |
| Lead Temp. (Soldering, 5 s)       |                    | 300  | °C   |
| Power Dissipation                 | Internally Limited |      |      |
| Storage temperature, $T_{stg}$    | -65                | 150  | °C   |

- (1) Stresses beyond those listed under *Absolute Maximum Ratings* may cause permanent damage to the device. These are stress ratings only, which do not imply functional operation of the device at these or any other conditions beyond those indicated under *Recommended Operating Conditions*. Exposure to absolute-maximum-rated conditions for extended periods may affect device reliability.
- (2) If Military/Aerospace specified devices are required, please contact the Texas Instruments Sales Office/ Distributors for availability and specifications.

### 6.2 ESD Ratings: LM27313

|                                     | VALUE  | UNIT  |
|-------------------------------------|--|-------|
| $V_{(ESD)}$ Electrostatic discharge | Human body model (HBM), per ANSI/ESDA/JEDEC JS-001, all pins <sup>(1)</sup>              | ±2000 |
|                                     | Charged device model (CDM), per JEDEC specification JESD22-C101, all pins <sup>(2)</sup> | ±1000 |

- (1) JEDEC document JEP155 states that 500-V HBM allows safe manufacturing with a standard ESD control process.
- (2) JEDEC document JEP157 states that 250-V CDM allows safe manufacturing with a standard ESD control process.

### 6.3 ESD Ratings: LM27313-Q1

|  |   |                              | VALUE | UNIT |
|--|---|------------------------------|-------|------|
| V <sub>(ESD)</sub> Electrostatic discharge | Human body model (HBM), per AEC Q100-002 <sup>(1)</sup> |                              | ±2000 | V    |
|  | Charged device model (CDM), per AEC Q100-011            | Corner pins (1, 3, 4, and 5) | ±1000 |      |
|  |   | Other pins                   | ±1000 |      |

(1) AEC Q100-002 indicates HBM stressing is done in accordance with the ANSI/ESDA/JEDEC JS-001 specification.

### 6.4 Recommended Operating Conditions

|                                      | MIN | NOM | MAX             | UNIT |
|--------------------------------------|-----|-----|-----------------|------|
| V <sub>IN</sub>                      | 2.7 |     | 14              | V    |
| V <sub>SW(MAX)</sub>                 |     |     | 30              | V    |
| V <sub>SHDN</sub>                    | 0   |     | V <sub>IN</sub> | V    |
| Junction Temperature, T <sub>J</sub> | -40 |     | 125             | °C   |

### 6.5 Thermal Information

| THERMAL METRIC <sup>(1)</sup> |  | LM27313,<br>LM27313-Q1 | UNIT |
|-------------------------------|--|------------------------|------|
|                               |  | DBV                    |      |
|                               |  | 5 PINS                 |      |
| R <sub>θJA</sub>              | Junction-to-ambient thermal resistance       | 166.3                  | °C/W |
| R <sub>θJC(top)</sub>         | Junction-to-case (top) thermal resistance    | 71.8                   |      |
| R <sub>θJB</sub>              | Junction-to-board thermal resistance         | 28.1                   |      |
| ψ <sub>JT</sub>               | Junction-to-top characterization parameter   | 2.1                    |      |
| ψ <sub>JB</sub>               | Junction-to-board characterization parameter | 27.7                   |      |
| R <sub>θJC(bot)</sub>         | Junction-to-case (bottom) thermal resistance | N/A                    |      |

(1) For more information about traditional and new thermal metrics, see the *IC Package Thermal Metrics* application report, [SPRA953](#).

## 6.6 Electrical Characteristics

Unless otherwise specified:  $V_{IN} = 5\text{ V}$ ,  $V_{SHDN} = 5\text{ V}$ ,  $I_L = 0\text{ mA}$ , and  $T_J = 25^\circ\text{C}$ . Minimum and Maximum limits are ensured through test, design, or statistical correlation. Typical values represent the most likely parametric norm at  $T_J = 25^\circ\text{C}$ , and are provided for reference purposes only.

| PARAMETER                     |                                | TEST CONDITIONS   | MIN   | TYP   | MAX   | UNIT          |
|-------------------------------|--------------------------------|---|-------|-------|-------|---------------|
| $V_{IN}$                      | Input Voltage                  | $-40^\circ\text{C} \leq T_J \leq +125^\circ\text{C}$  | 2.7   |       | 14    | V             |
| $I_{SW}$                      | Switch Current Limit           | See <sup>(1)</sup>  | 0.80  | 1.25  |       | A             |
| $R_{DS(ON)}$                  | Switch ON Resistance           | $I_{SW} = 100\text{ mA}$  |       | 500   | 650   | m $\Omega$    |
| $V_{SHDN(TH)}$                | Shutdown Threshold             | Device ON, $-40^\circ\text{C} \leq T_J \leq +125^\circ\text{C}$                               | 1.5   |       |       | V             |
|                               |                                | Device OFF, $-40^\circ\text{C} \leq T_J \leq +125^\circ\text{C}$                              |       |       | 0.50  |               |
| $I_{SHDN}$                    | Shutdown Pin Bias Current      | $V_{SHDN} = 0$  |       | 0     |       | $\mu\text{A}$ |
|                               |                                | $V_{SHDN} = 5\text{ V}$   |       | 0     | 2     |               |
|                               |                                | $V_{SHDN} = 5\text{ V}$ , $-40^\circ\text{C} \leq T_J \leq +125^\circ\text{C}$                |       |       |       |               |
| $V_{FB}$                      | Feedback Pin Reference Voltage | $V_{IN} = 3\text{ V}$   |       | 1.230 |       | V             |
|                               |                                | $V_{IN} = 3\text{ V}$ , $-40^\circ\text{C} \leq T_J \leq +125^\circ\text{C}$                  | 1.205 |       | 1.255 |               |
| $I_{FB}$                      | Feedback Pin Bias Current      | $V_{FB} = 1.23\text{ V}$  |       | 60    |       | nA            |
| $I_Q$                         | Quiescent Current              | $V_{SHDN} = 5\text{ V}$ , Switching   |       | 2.1   |       | mA            |
|                               |                                | $V_{SHDN} = 5\text{ V}$ , Switching, $-40^\circ\text{C} \leq T_J \leq +125^\circ\text{C}$     |       |       | 3.0   |               |
|                               |                                | $V_{SHDN} = 5\text{ V}$ , Not Switching   |       | 400   |       | $\mu\text{A}$ |
|                               |                                | $V_{SHDN} = 5\text{ V}$ , Not Switching, $-40^\circ\text{C} \leq T_J \leq +125^\circ\text{C}$ |       |       | 500   |               |
|                               |                                | $V_{SHDN} = 0$  |       | 0.024 | 1     |               |
| $\Delta V_{FB}/\Delta V_{IN}$ | FB Voltage Line Regulation     | $2.7\text{ V} \leq V_{IN} \leq 14\text{ V}$   |       | 0.02  |       | %/V           |
| $f_{SW}$                      | Switching Frequency            |   |       | 1.6   |       | MHz           |
|                               |                                | $-40^\circ\text{C} \leq T_J \leq +125^\circ\text{C}$  | 1.15  |       | 1.90  |               |
| $D_{MAX}$                     | Maximum Duty Cycle             |   |       | 88%   |       |               |
|                               |                                | $-40^\circ\text{C} \leq T_J \leq +125^\circ\text{C}$  | 80%   |       |       |               |
| $I_L$                         | Switch Leakage                 | Not Switching, $V_{SW} = 5\text{ V}$  |       |       | 1     | $\mu\text{A}$ |

(1) Switch current limit is dependent on duty cycle. Limits shown are for duty cycles  $\leq 50\%$ . See [Figure 15](#).

## 6.7 Typical Characteristics

Unless otherwise specified:  $V_{IN} = 5\text{ V}$ , SHDN pin is tied to  $V_{IN}$ ,  $T_J = 25^\circ\text{C}$ .

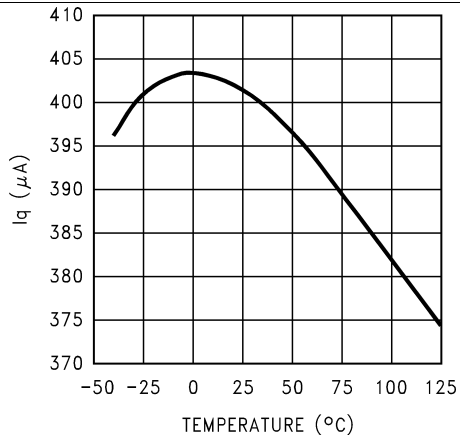

**Figure 1.  $I_q$   $V_{IN}$  (Active) vs Temperature**

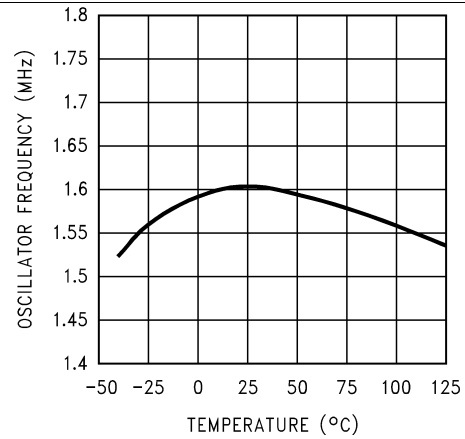

**Figure 2. Oscillator Frequency vs Temperature**

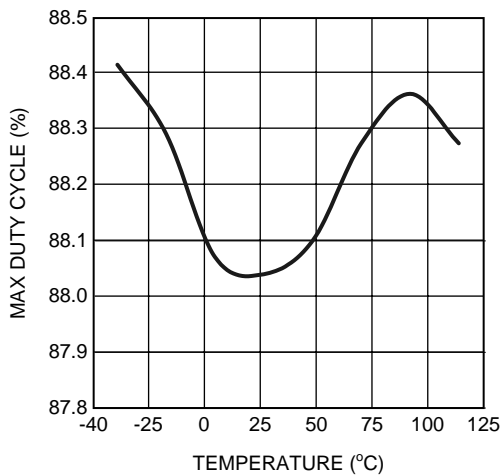

**Figure 3. Max. Duty Cycle vs Temperature**

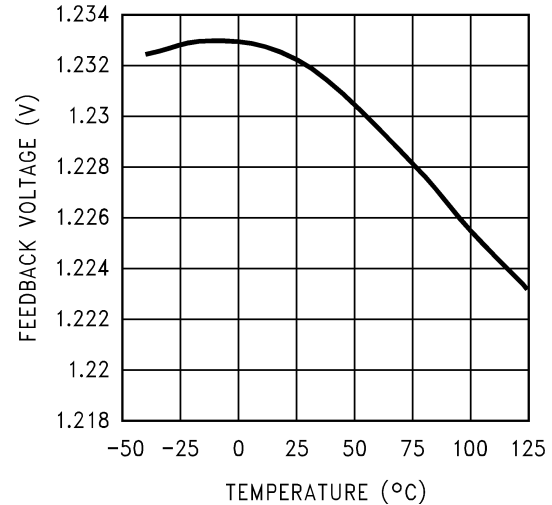

**Figure 4. Feedback Voltage vs Temperature**

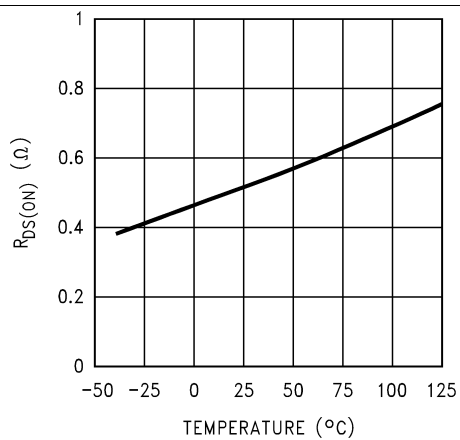

**Figure 5.  $R_{DS(ON)}$  vs Temperature**

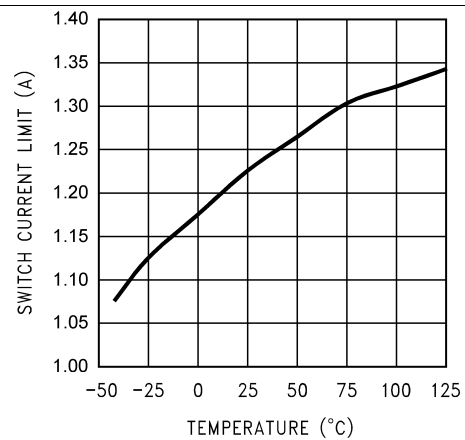

**Figure 6. Current Limit vs Temperature**

Typical Characteristics (continued)

Unless otherwise specified:  $V_{IN} = 5\text{ V}$ , SHDN pin is tied to  $V_{IN}$ ,  $T_J = 25^\circ\text{C}$ .

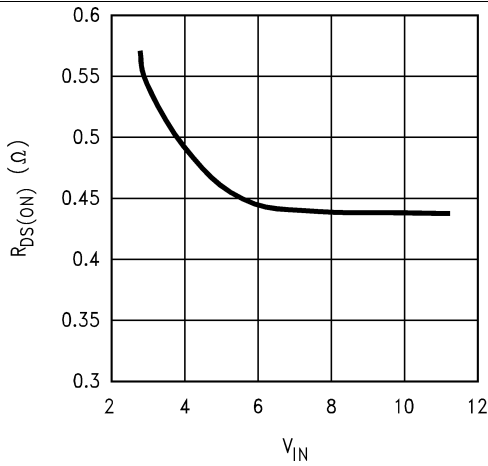

Figure 7.  $R_{DS(ON)}$  vs  $V_{IN}$

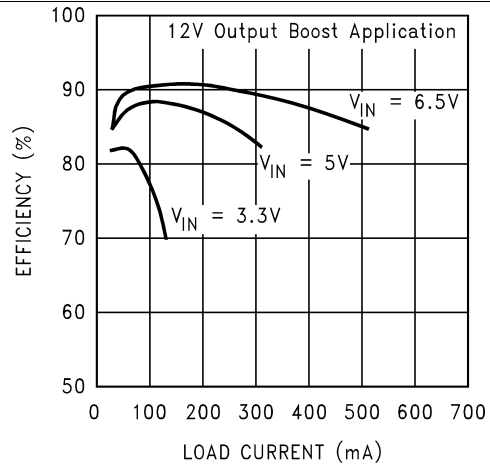

Figure 8. Efficiency vs Load Current ( $V_{OUT} = 12\text{ V}$ )

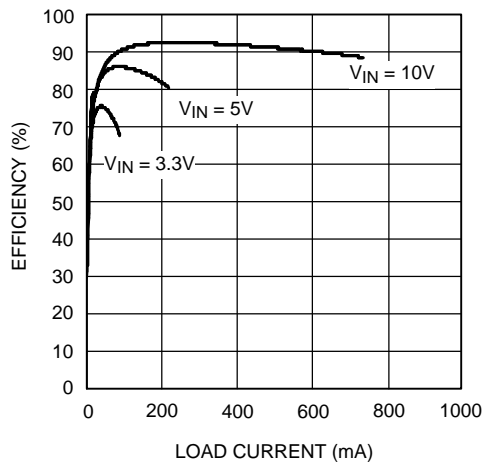

Figure 9. Efficiency vs Load Current ( $V_{OUT} = 15\text{ V}$ )

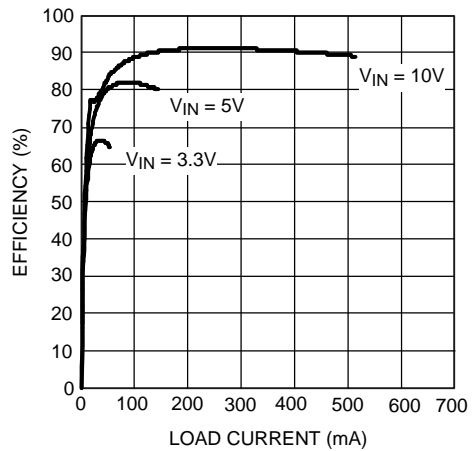

Figure 10. Efficiency vs Load Current ( $V_{OUT} = 20\text{ V}$ )

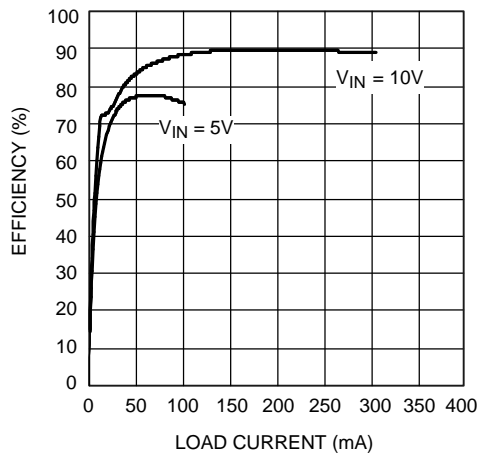

Figure 11. Efficiency vs Load Current ( $V_{OUT} = 25\text{ V}$ )

## 7 Detailed Description

### 7.1 Overview

The LM27313 is a switching converter IC that operates at a fixed frequency of 1.6 MHz using current-mode control for fast transient response over a wide input voltage range and incorporate pulse-by-pulse current limiting protection. Because this is current mode control, a 50-mΩ sense resistor in series with the switch FET is used to provide a voltage (which is proportional to the FET current) to both the input of the pulse width modulation (PWM) comparator and the current limit amplifier.

At the beginning of each cycle, the S-R latch turns on the FET. As the current through the FET increases, a voltage (proportional to this current) is summed with the ramp coming from the ramp generator and then fed into the input of the PWM comparator. When this voltage exceeds the voltage on the other input (coming from the Gm amplifier), the latch resets and turns the FET off. Because the signal coming from the Gm amplifier is derived from the feedback (which samples the voltage at the output), the action of the PWM comparator constantly sets the correct peak current through the FET to keep the output voltage in regulation.

Q1 and Q2 along with R3 - R6 form a bandgap voltage reference used by the IC to hold the output in regulation. The currents flowing through Q1 and Q2 will be equal, and the feedback loop will adjust the regulated output to maintain this. Because of this, the regulated output is always maintained at a voltage level equal to the voltage at the FB node "multiplied up" by the ratio of the output resistive divider.

The current limit comparator feeds directly into the flip-flop, that drives the switch FET. If the FET current reaches the limit threshold, the FET is turned off and the cycle terminated until the next clock pulse. The current limit input terminates the pulse regardless of the status of the output of the PWM comparator.

### 7.2 Functional Block Diagram

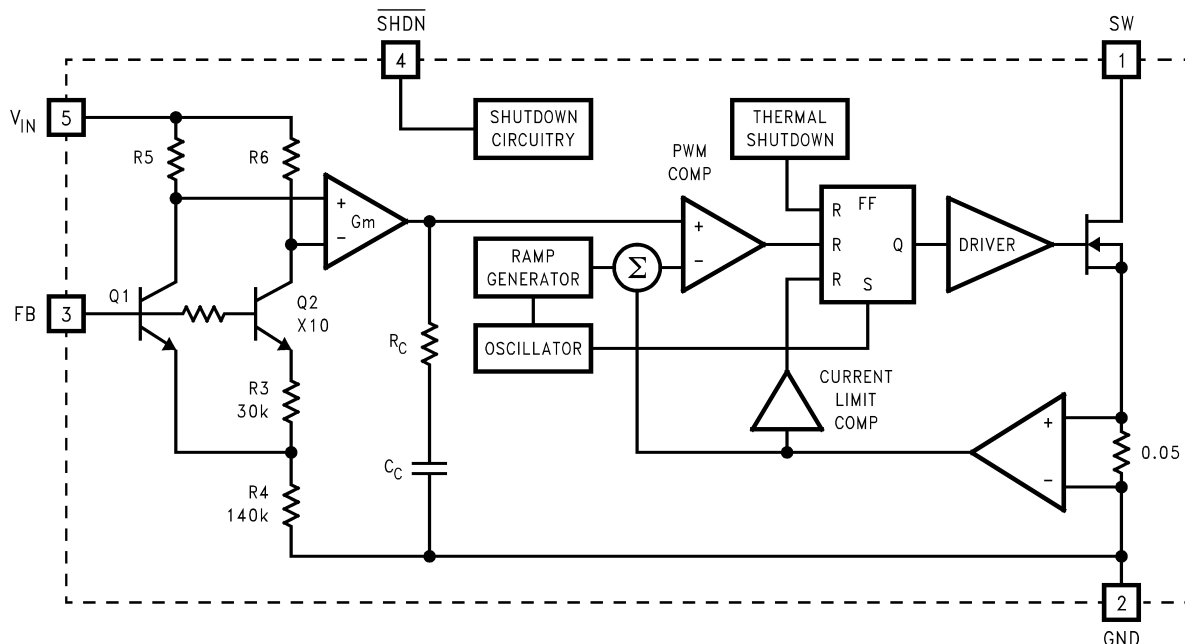

### 7.3 Feature Description

This device is designed as a current mode boost converter for a wide input voltage range. It features a very small package and operates at a high switching frequency. This allows for use of small passive components (inductors and capacitors), enabling small solution size. The device features also logic level shutdown, making it ideal for applications where low power consumption is desired. Control loop compensation is internal and no additional external components are required. Additional protection features are provided by deploying cycle-by-cycle current limiting and thermal shutdown.

## 7.4 Device Functional Modes

In normal operational mode, the device regulates output voltage to the value set with resistive divider. In addition, this device has a logic level shutdown pin (SHDN) that allows user to turn the device on/off by driving this pin high/low. Default setup is that this pin is connected to  $V_{IN}$  through pullup resistor (typically 50 k $\Omega$ ). When shutdown pin is low, the device is in shutdown mode consuming typically only 24 nA, making it ideal for applications where low power consumption is desirable.

## 8 Application and Implementation

### NOTE

Information in the following applications sections is not part of the TI component specification, and TI does not warrant its accuracy or completeness. TI's customers are responsible for determining suitability of components for their purposes. Customers should validate and test their design implementation to confirm system functionality.

### 8.1 Application Information

The device operates with input voltage in the range of 2.7 V to 14 V and provides regulated output voltage. This device is optimized for high-efficiency operation with minimum number of external components. Also, high switching frequency allows use of small surface mount components, enabling very small solution size. For component selection, refer to [Detailed Design Procedure](#).

### 8.2 Typical Applications

#### 8.2.1 Application Circuit $V_{IN}=5.0\text{ V}$ , $V_{OUT}=12.0\text{ V}$ , $I_{load}=250\text{ mA}$

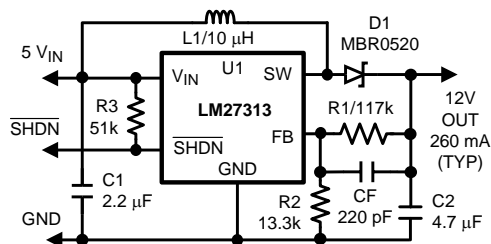

**Figure 12. Typical Application Circuit**

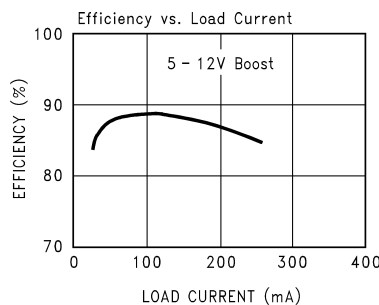

**Figure 13. Efficiency vs. Load Current**

#### 8.2.1.1 Design Requirements

The device must be able to operate at any voltage within input voltage range.

Load Current must be defined in order to properly size the inductor, input and output capacitors. The inductor should be able to handle full expected load current as well as the peak current generated during load transients and start up. Inrush current at startup will depend on the output capacitor selection. More details are provided in [Detailed Design Procedure](#).

Device has a shutdown pin (SHDN) that is used to enable and disable device. This pin is active low and should be tied to  $V_{IN}$  if not used in application.

## Typical Applications (continued)

### 8.2.1.2 Detailed Design Procedure

#### 8.2.1.2.1 Selecting the External Capacitors

The LM27313 requires ceramic capacitors at the input and output to accommodate the peak switching currents the part needs to operate. Electrolytic capacitors have resonant frequencies which are below the switching frequency of the device, and therefore can not provide the currents needed to operate. Electrolytics may be used in parallel with the ceramics for bulk charge storage which will improve transient response.

When selecting a ceramic capacitor, only X5R and X7R dielectric types should be used. Other types such as Z5U and Y5F have such severe loss of capacitance due to effects of temperature variation and applied voltage, they may provide as little as 20% of rated capacitance in many typical applications. Always consult capacitor manufacturer's data curves before selecting a capacitor. High-quality ceramic capacitors can be obtained from Taiyo-Yuden, AVX, and Murata.

#### 8.2.1.2.2 Selecting the Output Capacitor

A single ceramic capacitor of value 4.7  $\mu\text{F}$  to 10  $\mu\text{F}$  provides sufficient output capacitance for most applications. For output voltages below 10 V, a 10  $\mu\text{F}$  capacitance is required. If larger amounts of capacitance are desired for improved line support and transient response, tantalum capacitors can be used in parallel with the ceramics. Aluminum electrolytics with ultra low ESR such as Sanyo Oscon can be used, but are usually prohibitively expensive. Typical Al electrolytic capacitors are not suitable for switching frequencies above 500 kHz due to significant ringing and temperature rise due to self-heating from ripple current. An output capacitor with excessive ESR can also reduce phase margin and cause instability.

#### 8.2.1.2.3 Selecting the Input Capacitor

An input capacitor is required to serve as an energy reservoir for the current which must flow into the inductor each time the switch turns ON. This capacitor must have extremely low ESR and ESL, so ceramic must be used. We recommend a nominal value of 2.2  $\mu\text{F}$ , but larger values can be used. Because this capacitor reduces the amount of voltage ripple seen at the input pin, it also reduces the amount of EMI passed back along that line to other circuitry.

#### 8.2.1.2.4 Feed-Forward Compensation

Although internally compensated, the feed-forward capacitor  $C_f$  is required for stability (see [Equation 1](#)). Adding this capacitor puts a zero in the loop response of the converter. Without it, the regulator loop can oscillate. The recommended frequency for the zero  $f_z$  should be approximately 8 kHz.  $C_f$  can be calculated using the formula:

$$C_f = 1 / (2 \times \pi \times R_1 \times f_z) \quad (1)$$

#### 8.2.1.2.5 Selecting Diodes

The external diode used in the typical application should be a Schottky diode. If the switch voltage is less than 15V, a 20V diode such as the MBR0520 is recommended. If the switch voltage is between 15 V and 25 V, a 30-V diode such as the MBR0530 is recommended. If the switch voltage exceeds 25V, a 40V diode such as the MBR0540 should be used.

The MBR05xx series of diodes are designed to handle a maximum average current of 500 mA. For applications with load currents to 800 mA, a Microsemi UPS5817 can be used.

#### 8.2.1.2.6 Setting the Output Voltage

The output voltage is set using the external resistors  $R_1$  and  $R_2$  (see [Equation 2](#)). A value of 13.3 k $\Omega$  is recommended for  $R_2$  to establish a divider current of approximately 92  $\mu\text{A}$ .  $R_1$  is calculated using the formula:

$$R_1 = R_2 \times (V_{\text{OUT}} / V_{\text{FB}} - 1) \quad (2)$$

#### 8.2.1.2.7 Duty Cycle

The maximum duty cycle of the switching regulator determines the maximum boost ratio of output-to-input voltage that the converter can attain in continuous mode of operation. The duty cycle for a given boost application is defined as:

## Typical Applications (continued)

$$\text{Duty Cycle} = \frac{V_{\text{OUT}} + V_{\text{DIODE}} - V_{\text{IN}}}{V_{\text{OUT}} + V_{\text{DIODE}} - V_{\text{SW}}} \quad (3)$$

This applies for continuous mode operation.

The equation shown for calculating duty cycle incorporates terms for the FET switch voltage and diode forward voltage. The actual duty cycle measured in operation will also be affected slightly by other power losses in the circuit such as wire losses in the inductor, switching losses, and capacitor ripple current losses from self-heating. Therefore, the actual (effective) duty cycle measured may be slightly higher than calculated to compensate for these power losses. A good approximation for effective duty cycle is:

$$\text{DC (eff)} = (1 - \text{Efficiency} \times (V_{\text{IN}} / V_{\text{OUT}}))$$

where

- the efficiency can be approximated from the curves provided. (4)

### 8.2.1.2.8 Inductance Value

The first question we are usually asked is: “How small can I make the inductor?” (because they are the largest sized component and usually the most costly). The answer is not simple and involves trade-offs in performance. More inductance means less inductor ripple current and less output voltage ripple (for a given size of output capacitor). More inductance also means more load power can be delivered because the energy stored during each switching cycle is:

$$E = L/2 \times (I_p)^2$$

where

- $I_p$  is the peak inductor current. (5)

An important point to observe is that the LM27313 will limit its switch current based on peak current. This means that because  $I_p(\text{max})$  is fixed, increasing  $L$  will increase the maximum amount of power available to the load. Conversely, using too little inductance may limit the amount of load current which can be drawn from the output.

Best performance is usually obtained when the converter is operated in “continuous” mode at the load current range of interest, typically giving better load regulation and less output ripple. Continuous operation is defined as not allowing the inductor current to drop to zero during the cycle. It should be noted that all boost converters shift over to discontinuous operation as the output load is reduced far enough, but a larger inductor stays “continuous” over a wider load current range.

To better understand these tradeoffs, a typical application circuit (5V to 12V boost with a 10  $\mu\text{H}$  inductor) will be analyzed.

Because the LM27313 typical switching frequency is 1.6 MHz, the typical period is equal to  $1/f_{\text{SW(TYP)}}$ , or approximately 0.625  $\mu\text{s}$ .

We will assume:  $V_{\text{IN}} = 5 \text{ V}$ ,  $V_{\text{OUT}} = 12 \text{ V}$ ,  $V_{\text{DIODE}} = 0.5 \text{ V}$ ,  $V_{\text{SW}} = 0.5 \text{ V}$ . The duty cycle is:

$$\text{Duty Cycle} = ((12 \text{ V} + 0.5 \text{ V} - 5 \text{ V}) / (12 \text{ V} + 0.5 \text{ V} - 0.5 \text{ V})) = 62.5\% \quad (6)$$

The typical ON time of the switch is:

$$(62.5\% \times 0.625 \mu\text{s}) = 0.390 \mu\text{s} \quad (7)$$

It should be noted that when the switch is ON, the voltage across the inductor is approximately 4.5 V.

Use the equation:

$$V = L (di/dt) \quad (8)$$

Then, calculate the  $di/dt$  rate of the inductor which is found to be 0.45 A/ $\mu\text{s}$  during the ON time. Using these facts, we can then show what the inductor current will look like during operation:

Typical Applications (continued)

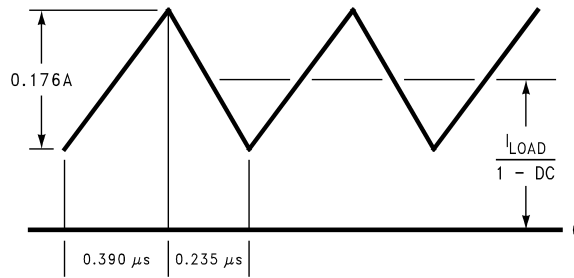

Figure 14. 10 µH Inductor Current, 5 V – 12 V Boost

During the 0.390-µs ON time, the inductor current ramps up 0.176 A and ramps down an equal amount during the OFF time. This is defined as the inductor “ripple current”. It can also be seen that if the load current drops to about 33 mA, the inductor current will begin touching the zero axis which means it will be in discontinuous mode. A similar analysis can be performed on any boost converter, to make sure the ripple current is reasonable and continuous operation will be maintained at the typical load current values.

8.2.1.2.9 Maximum Switch Current

The maximum FET switch current available before the current limiter cuts in is dependent on duty cycle of the application. This is illustrated in Figure 15 which shows typical values of switch current as a function of effective (actual) duty cycle:

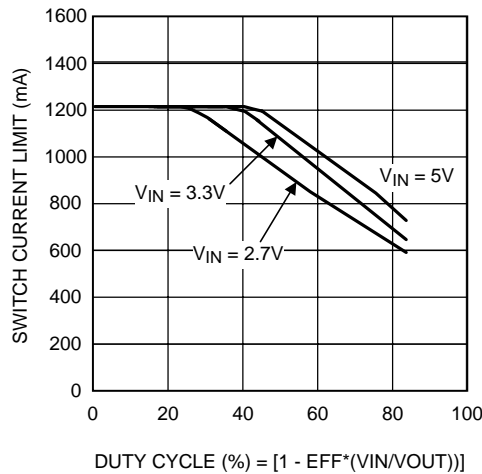

Figure 15. Switch Current Limit vs Duty Cycle

8.2.1.2.10 Calculating Load Current

As shown in Figure 14 which depicts inductor current, the load current is related to the average inductor current by the relation:

$$I_{LOAD} = I_{IND(AVG)} \times (1 - DC)$$

where

- DC is the duty cycle of the application. (9)

The switch current can be found by:

$$I_{SW} = I_{IND(AVG)} + \frac{1}{2} (I_{RIPPLE})$$
 (10)

Inductor ripple current is dependent on inductance, duty cycle, input voltage and frequency:

$$I_{RIPPLE} = DC \times (V_{IN} - V_{SW}) / (f_{SW} \times L)$$
 (11)

**Typical Applications (continued)**

Combining all terms, we can develop an expression which allows the maximum available load current to be calculated:

$$I_{LOAD(max)} = \frac{(1 - DC) \times (I_{SW(max)} - DC (V_{IN} - V_{SW}))}{2fL} \tag{12}$$

The equation shown to calculate maximum load current takes into account the losses in the inductor or turn-OFF switching losses of the FET and diode. For actual load current in typical applications, we took bench data for various input and output voltages and displayed the maximum load current available for a typical device in graph form:

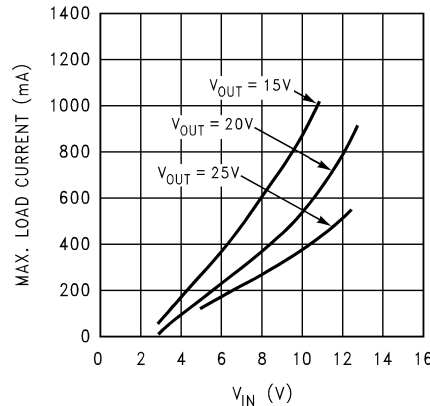

**Figure 16. Max. Load Current vs V<sub>IN</sub>**

**8.2.1.2.11 Design Parameters V<sub>SW</sub> and I<sub>SW</sub>**

The value of the FET ON voltage (referred to as V<sub>SW</sub> in the equations) is dependent on load current. A good approximation can be obtained by multiplying the "ON Resistance" of the FET times the average inductor current.

FET ON resistance increases at V<sub>IN</sub> values below 5V, because the internal N-FET has less gate voltage in this input voltage range (see *Typical Characteristics*). Above V<sub>IN</sub> = 5 V, the FET gate voltage is internally clamped to 5V.

The maximum peak switch current the device can deliver is dependent on duty cycle. The minimum switch current value (I<sub>SW</sub>) is ensured to be at least 800 mA at duty cycles below 50%. For higher duty cycles, see *Typical Characteristics*.

**8.2.1.2.12 Minimum Inductance**

In some applications where the maximum load current is relatively small, it may be advantageous to use the smallest possible inductance value for cost and size savings. The converter will operate in discontinuous mode in such a case.

The minimum inductance should be selected such that the inductor (switch) current peak on each cycle does not reach the 800 mA current limit maximum. To understand how to do this, an example will be presented.

In this example, the LM27313 nominal switching frequency is 1.6 MHz, and the minimum switching frequency is 1.15 MHz. This means the maximum cycle period is the reciprocal of the minimum frequency:

$$T_{ON(max)} = 1/1.15M = 0.870 \mu s \tag{13}$$

Assume: V<sub>IN</sub> = 5 V, V<sub>OUT</sub> = 12 V, V<sub>SW</sub> = 0.2 V, and V<sub>DIODE</sub> = 0.3 V. The duty cycle is:

$$Duty\ Cycle = ((12\ V + 0.3\ V - 5\ V) / (12\ V + 0.3\ V - 0.2\ V)) = 60.3\% \tag{14}$$

Therefore, the maximum switch ON time is:

$$(60.3\% \times 0.870 \mu s) = 0.524 \mu s \tag{15}$$

## Typical Applications (continued)

An inductor should be selected with enough inductance to prevent the switch current from reaching 800 mA in the 0.524  $\mu$ s ON time interval (see Figure 17):

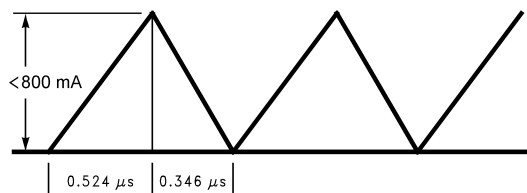

Figure 17. Discontinuous Design, 5 V – 12 V Boost

The voltage across the inductor during ON time is 4.8 V. Minimum inductance value is found by:

$$L = V \times (dt/dI) \tag{16}$$

$$L = 4.8 \text{ V} \times (0.524 \mu\text{s} / 0.8 \text{ mA}) = 3.144 \mu\text{H} \tag{17}$$

In this case, a 3.3- $\mu$ H inductor could be used, assuming it provided at least that much inductance up to the 800-mA current value. This same analysis can be used to find the minimum inductance for any boost application.

### 8.2.1.2.13 Inductor Suppliers

Some of the recommended suppliers of inductors for this product include, but are not limited to, Sumida, Coilcraft, Panasonic, TDK and Murata. When selecting an inductor, make certain that the continuous current rating is high enough to avoid saturation at peak currents. A suitable core type must be used to minimize core (switching) losses, and wire power losses must be considered when selecting the current rating.

### 8.2.1.2.14 Shutdown Pin Operation

The device is turned off by pulling the shutdown pin low. If this function is not going to be used, the pin should be tied directly to  $V_{IN}$ . If the SHDN function will be needed, a pullup resistor must be used to  $V_{IN}$  (50 k $\Omega$  to 100 k $\Omega$  is recommended), or the pin must be actively driven high and low. The SHDN pin must not be left unterminated.

## 8.2.1.3 Application Curves

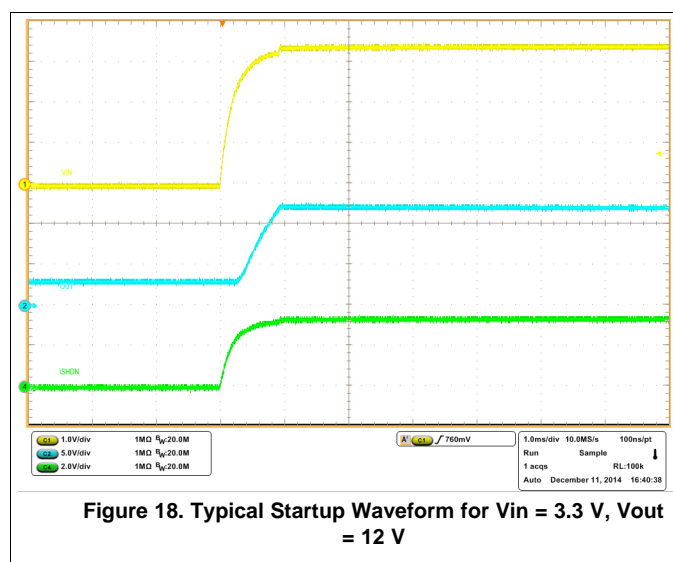

Figure 18. Typical Startup Waveform for  $V_{in} = 3.3 \text{ V}$ ,  $V_{out} = 12 \text{ V}$

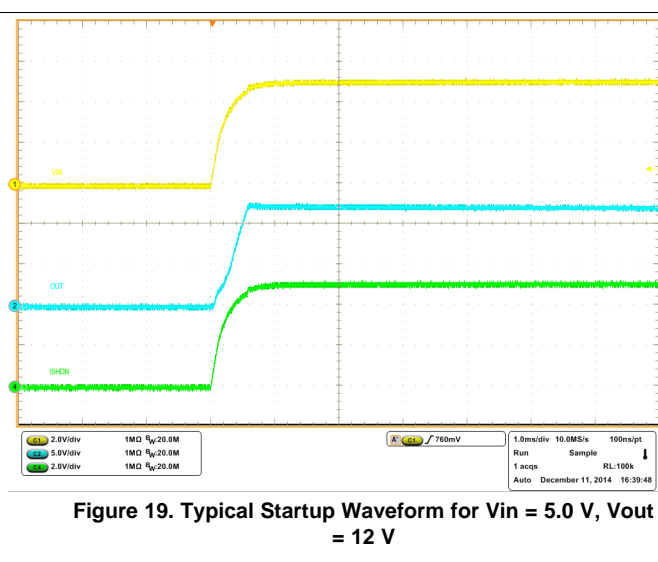
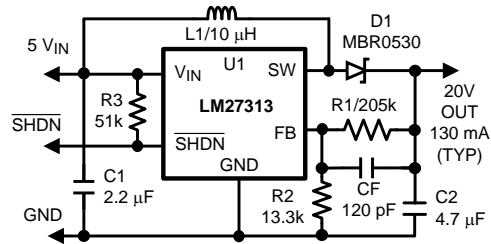
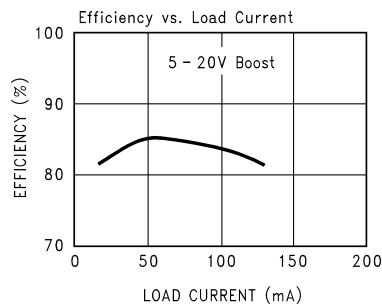

Figure 19. Typical Startup Waveform for  $V_{in} = 5.0 \text{ V}$ ,  $V_{out} = 12 \text{ V}$

**Typical Applications (continued)**
**8.2.2 Application Circuit  $V_{IN}=5.0V$ ,  $V_{OUT}=20.0V$ ,  $I_{load}=150mA$** 

**Figure 20. Typical Application Circuit**

**Figure 21. Efficiency vs. Load Current**
**8.2.2.1 Design Requirements**

 See [Design Requirements](#).

**8.2.2.2 Detailed Design Procedure**

 See [Detailed Design Procedure](#).

**8.2.2.3 Application Curves**

 See [Application Curves](#).

## 9 Power Supply Recommendations

The LM27313 is designed to operate from an input voltage supply range from 2.7 V to 14 V. This input supply should be able to withstand the maximum input current and maintain a voltage above 2.7 V. In cases where input supply is located farther away (more than a few inches) from LM27313, additional bulk capacitance may be required in addition to the ceramic bypass capacitors.

## 10 Layout

### 10.1 Layout Guidelines

High-frequency switching regulators require very careful layout of components in order to get stable operation and low noise. All components must be as close as possible to the LM27313 device. It is recommended that a 4-layer PCB be used so that internal ground planes are available.

Some additional guidelines to be observed:

1. Keep the path between L1, D1, and C2 extremely short. Parasitic trace inductance in series with D1 and C2 will increase noise and ringing.
2. The feedback components R1, R2 and CF must be kept close to the FB pin of the LM27313 to prevent noise injection on the high impedance FB pin.
3. If internal ground planes are available (recommended) use vias to connect directly to the LM27313 ground at device pin 2, as well as the negative sides of capacitors C1 and C2.

### 10.2 Layout Example

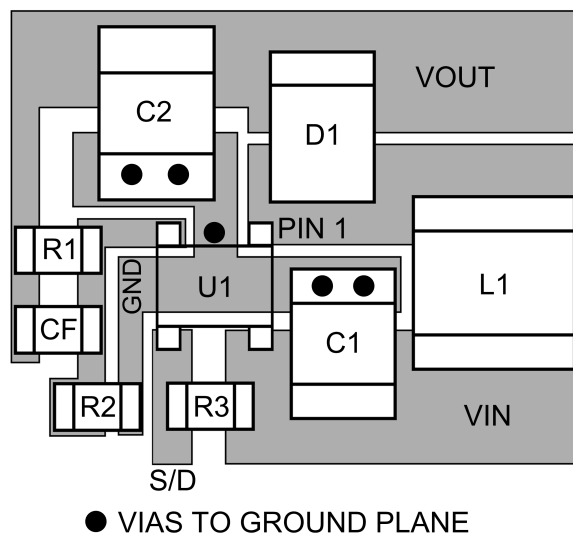

Figure 22. Recommended PCB Component Layout

### 10.3 Thermal Considerations

At higher duty cycles, the increased ON time of the FET means the maximum output current will be determined by power dissipation within the LM27313 FET switch. The switch power dissipation from ON-state conduction is calculated by:

$$P_{SW} = DC \times I_{IND(AVG)}^2 \times R_{DS(ON)} \quad (18)$$

There will be some switching losses as well, so some derating needs to be applied when calculating IC power dissipation.

## 11 Device and Documentation Support

### 11.1 Device Support

#### 11.1.1 Third-Party Products Disclaimer

TI'S PUBLICATION OF INFORMATION REGARDING THIRD-PARTY PRODUCTS OR SERVICES DOES NOT CONSTITUTE AN ENDORSEMENT REGARDING THE SUITABILITY OF SUCH PRODUCTS OR SERVICES OR A WARRANTY, REPRESENTATION OR ENDORSEMENT OF SUCH PRODUCTS OR SERVICES, EITHER ALONE OR IN COMBINATION WITH ANY TI PRODUCT OR SERVICE.

#### 11.2 Related Links

The table below lists quick access links. Categories include technical documents, support and community resources, tools and software, and quick access to sample or buy.

**Table 1. Related Links**

| PARTS      | PRODUCT FOLDER             | SAMPLE & BUY               | TECHNICAL DOCUMENTS        | TOOLS & SOFTWARE           | SUPPORT & COMMUNITY        |
|------------|----------------------------|----------------------------|----------------------------|----------------------------|----------------------------|
| LM27313    | <a href="#">Click here</a> | <a href="#">Click here</a> | <a href="#">Click here</a> | <a href="#">Click here</a> | <a href="#">Click here</a> |
| LM27313-Q1 | <a href="#">Click here</a> | <a href="#">Click here</a> | <a href="#">Click here</a> | <a href="#">Click here</a> | <a href="#">Click here</a> |

#### 11.3 Trademarks

All trademarks are the property of their respective owners.

#### 11.4 Electrostatic Discharge Caution



These devices have limited built-in ESD protection. The leads should be shorted together or the device placed in conductive foam during storage or handling to prevent electrostatic damage to the MOS gates.

#### 11.5 Glossary

[SLYZ022](#) — *TI Glossary*.

This glossary lists and explains terms, acronyms, and definitions.

## 12 Mechanical, Packaging, and Orderable Information

The following pages include mechanical, packaging, and orderable information. This information is the most current data available for the designated devices. This data is subject to change without notice and revision of this document. For browser-based versions of this data sheet, refer to the left-hand navigation.

**PACKAGING INFORMATION**

| Orderable Device | Status<br>(1) | Package Type | Package Drawing | Pins | Package Qty | Eco Plan<br>(2) | Lead finish/<br>Ball material<br>(6) | MSL Peak Temp<br>(3) | Op Temp (°C) | Device Marking<br>(4/5) | Samples                 |
|------------------|---------------|--------------|-----------------|------|-------------|-----------------|--------------------------------------|----------------------|--------------|-------------------------|-------------------------|
| LM27313XMF/NOPB  | ACTIVE        | SOT-23       | DBV             | 5    | 1000        | RoHS & Green    | SN                                   | Level-1-260C-UNLIM   | -40 to 125   | SRPB                    | <a href="#">Samples</a> |
| LM27313XMF/NOPB  | ACTIVE        | SOT-23       | DBV             | 5    | 3000        | RoHS & Green    | SN                                   | Level-1-260C-UNLIM   | -40 to 125   | SRPB                    | <a href="#">Samples</a> |
| LM27313XQMF/NOPB | ACTIVE        | SOT-23       | DBV             | 5    | 1000        | RoHS & Green    | SN                                   | Level-1-260C-UNLIM   | -40 to 125   | SD3B                    | <a href="#">Samples</a> |
| LM27313XQMF/NOPB | ACTIVE        | SOT-23       | DBV             | 5    | 3000        | RoHS & Green    | SN                                   | Level-1-260C-UNLIM   | -40 to 125   | SD3B                    | <a href="#">Samples</a> |

(1) The marketing status values are defined as follows:

**ACTIVE:** Product device recommended for new designs.

**LIFEBUY:** TI has announced that the device will be discontinued, and a lifetime-buy period is in effect.

**NRND:** Not recommended for new designs. Device is in production to support existing customers, but TI does not recommend using this part in a new design.

**PREVIEW:** Device has been announced but is not in production. Samples may or may not be available.

**OBSELETE:** TI has discontinued the production of the device.

(2) **RoHS:** TI defines "RoHS" to mean semiconductor products that are compliant with the current EU RoHS requirements for all 10 RoHS substances, including the requirement that RoHS substance do not exceed 0.1% by weight in homogeneous materials. Where designed to be soldered at high temperatures, "RoHS" products are suitable for use in specified lead-free processes. TI may reference these types of products as "Pb-Free".

**RoHS Exempt:** TI defines "RoHS Exempt" to mean products that contain lead but are compliant with EU RoHS pursuant to a specific EU RoHS exemption.

**Green:** TI defines "Green" to mean the content of Chlorine (Cl) and Bromine (Br) based flame retardants meet JS709B low halogen requirements of <=1000ppm threshold. Antimony trioxide based flame retardants must also meet the <=1000ppm threshold requirement.

(3) MSL, Peak Temp. - The Moisture Sensitivity Level rating according to the JEDEC industry standard classifications, and peak solder temperature.

(4) There may be additional marking, which relates to the logo, the lot trace code information, or the environmental category on the device.

(5) Multiple Device Markings will be inside parentheses. Only one Device Marking contained in parentheses and separated by a "-" will appear on a device. If a line is indented then it is a continuation of the previous line and the two combined represent the entire Device Marking for that device.

(6) Lead finish/Ball material - Orderable Devices may have multiple material finish options. Finish options are separated by a vertical ruled line. Lead finish/Ball material values may wrap to two lines if the finish value exceeds the maximum column width.

**Important Information and Disclaimer:**The information provided on this page represents TI's knowledge and belief as of the date that it is provided. TI bases its knowledge and belief on information provided by third parties, and makes no representation or warranty as to the accuracy of such information. Efforts are underway to better integrate information from third parties. TI has taken and

continues to take reasonable steps to provide representative and accurate information but may not have conducted destructive testing or chemical analysis on incoming materials and chemicals. TI and TI suppliers consider certain information to be proprietary, and thus CAS numbers and other limited information may not be available for release.

In no event shall TI's liability arising out of such information exceed the total purchase price of the TI part(s) at issue in this document sold by TI to Customer on an annual basis.

**OTHER QUALIFIED VERSIONS OF LM27313, LM27313-Q1 :**

- Catalog: [LM27313](#)
- Automotive: [LM27313-Q1](#)

NOTE: Qualified Version Definitions:

- Catalog - TI's standard catalog product
- Automotive - Q100 devices qualified for high-reliability automotive applications targeting zero defects

**TAPE AND REEL INFORMATION**

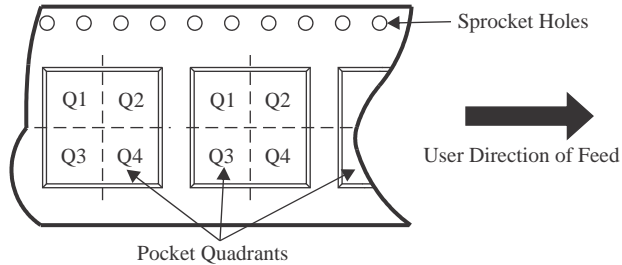
**QUADRANT ASSIGNMENTS FOR PIN 1 ORIENTATION IN TAPE**

\*All dimensions are nominal

| Device           | Package Type | Package Drawing | Pins | SPQ  | Reel Diameter (mm) | Reel Width W1 (mm) | A0 (mm) | B0 (mm) | K0 (mm) | P1 (mm) | W (mm) | Pin1 Quadrant |
|------------------|--------------|-----------------|------|------|--------------------|--------------------|---------|---------|---------|---------|--------|---------------|
| LM27313XMF/NOPB  | SOT-23       | DBV             | 5    | 1000 | 178.0              | 8.4                | 3.2     | 3.2     | 1.4     | 4.0     | 8.0    | Q3            |
| LM27313XMF/NOPB  | SOT-23       | DBV             | 5    | 3000 | 178.0              | 8.4                | 3.2     | 3.2     | 1.4     | 4.0     | 8.0    | Q3            |
| LM27313XQMF/NOPB | SOT-23       | DBV             | 5    | 1000 | 178.0              | 8.4                | 3.2     | 3.2     | 1.4     | 4.0     | 8.0    | Q3            |
| LM27313XQMF/NOPB | SOT-23       | DBV             | 5    | 3000 | 178.0              | 8.4                | 3.2     | 3.2     | 1.4     | 4.0     | 8.0    | Q3            |

**TAPE AND REEL BOX DIMENSIONS**

\*All dimensions are nominal

| Device           | Package Type | Package Drawing | Pins | SPQ  | Length (mm) | Width (mm) | Height (mm) |
|------------------|--------------|-----------------|------|------|-------------|------------|-------------|
| LM27313XMF/NOPB  | SOT-23       | DBV             | 5    | 1000 | 210.0       | 185.0      | 35.0        |
| LM27313XMF/NOPB  | SOT-23       | DBV             | 5    | 3000 | 210.0       | 185.0      | 35.0        |
| LM27313XQMF/NOPB | SOT-23       | DBV             | 5    | 1000 | 210.0       | 185.0      | 35.0        |
| LM27313XQMF/NOPB | SOT-23       | DBV             | 5    | 3000 | 210.0       | 185.0      | 35.0        |

# DBV0005A



# PACKAGE OUTLINE

SOT-23 - 1.45 mm max height

SMALL OUTLINE TRANSISTOR

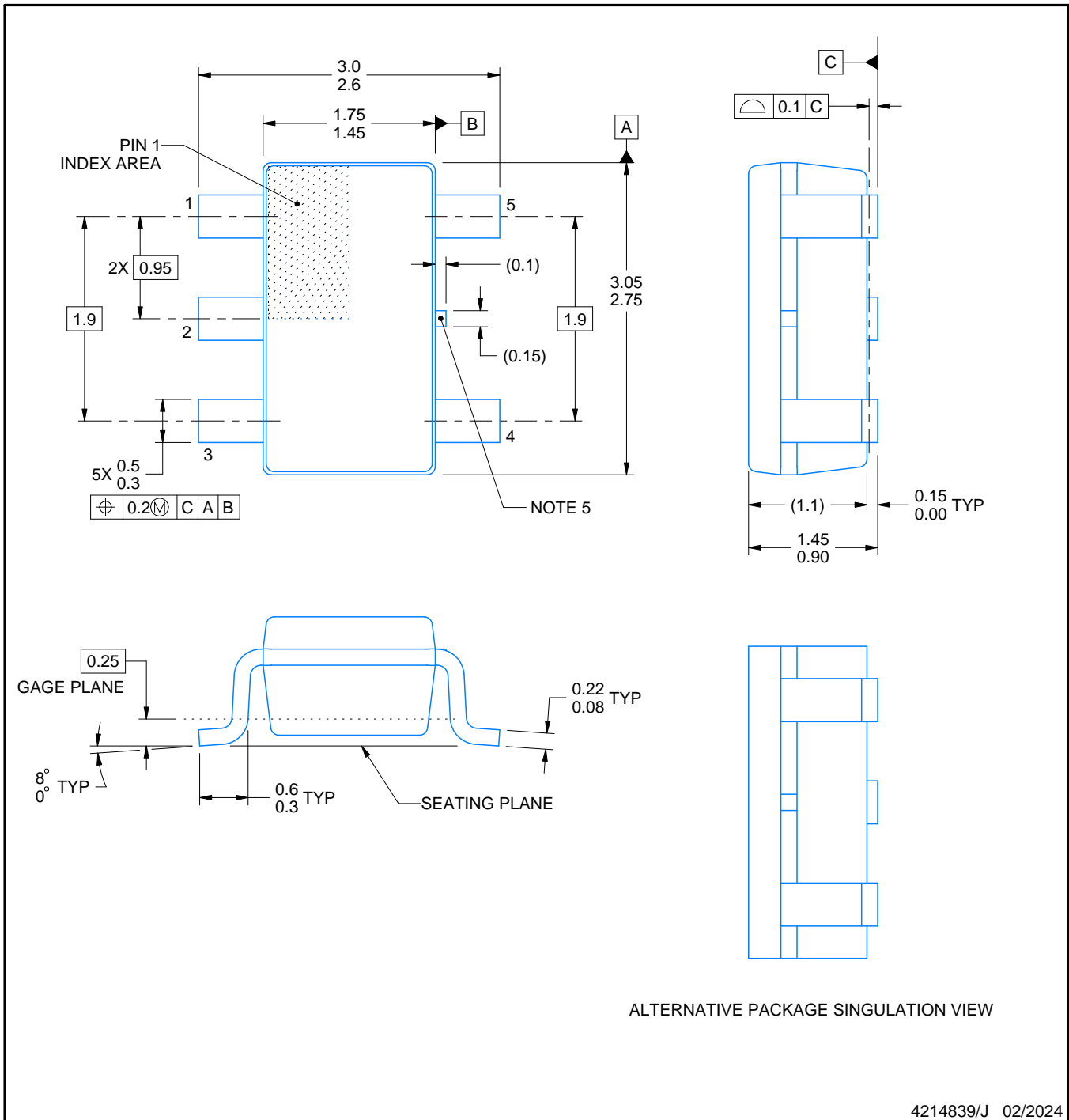

4214839/J 02/2024

**NOTES:**

1. All linear dimensions are in millimeters. Any dimensions in parenthesis are for reference only. Dimensioning and tolerancing per ASME Y14.5M.
2. This drawing is subject to change without notice.
3. Reference JEDEC MO-178.
4. Body dimensions do not include mold flash, protrusions, or gate burrs. Mold flash, protrusions, or gate burrs shall not exceed 0.25 mm per side.
5. Support pin may differ or may not be present.

# EXAMPLE BOARD LAYOUT

DBV0005A

SOT-23 - 1.45 mm max height

SMALL OUTLINE TRANSISTOR



LAND PATTERN EXAMPLE  
EXPOSED METAL SHOWN  
SCALE:15X



SOLDER MASK DETAILS

4214839/J 02/2024

NOTES: (continued)

- 6. Publication IPC-7351 may have alternate designs.
- 7. Solder mask tolerances between and around signal pads can vary based on board fabrication site.

# EXAMPLE STENCIL DESIGN

DBV0005A

SOT-23 - 1.45 mm max height

SMALL OUTLINE TRANSISTOR



SOLDER PASTE EXAMPLE  
BASED ON 0.125 mm THICK STENCIL  
SCALE:15X

4214839/J 02/2024

NOTES: (continued)

8. Laser cutting apertures with trapezoidal walls and rounded corners may offer better paste release. IPC-7525 may have alternate design recommendations.
9. Board assembly site may have different recommendations for stencil design.

## IMPORTANT NOTICE AND DISCLAIMER

TI PROVIDES TECHNICAL AND RELIABILITY DATA (INCLUDING DATA SHEETS), DESIGN RESOURCES (INCLUDING REFERENCE DESIGNS), APPLICATION OR OTHER DESIGN ADVICE, WEB TOOLS, SAFETY INFORMATION, AND OTHER RESOURCES "AS IS" AND WITH ALL FAULTS, AND DISCLAIMS ALL WARRANTIES, EXPRESS AND IMPLIED, INCLUDING WITHOUT LIMITATION ANY IMPLIED WARRANTIES OF MERCHANTABILITY, FITNESS FOR A PARTICULAR PURPOSE OR NON-INFRINGEMENT OF THIRD PARTY INTELLECTUAL PROPERTY RIGHTS.

These resources are intended for skilled developers designing with TI products. You are solely responsible for (1) selecting the appropriate TI products for your application, (2) designing, validating and testing your application, and (3) ensuring your application meets applicable standards, and any other safety, security, regulatory or other requirements.

These resources are subject to change without notice. TI grants you permission to use these resources only for development of an application that uses the TI products described in the resource. Other reproduction and display of these resources is prohibited. No license is granted to any other TI intellectual property right or to any third party intellectual property right. TI disclaims responsibility for, and you will fully indemnify TI and its representatives against, any claims, damages, costs, losses, and liabilities arising out of your use of these resources.

TI's products are provided subject to [TI's Terms of Sale](#) or other applicable terms available either on [ti.com](https://www.ti.com) or provided in conjunction with such TI products. TI's provision of these resources does not expand or otherwise alter TI's applicable warranties or warranty disclaimers for TI products.

TI objects to and rejects any additional or different terms you may have proposed.

Mailing Address: Texas Instruments, Post Office Box 655303, Dallas, Texas 75265  
Copyright © 2024, Texas Instruments Incorporated

## Looking for pricing, stock, or lifecycle information?

Click below to explore more details on WIN SOURCE:

 [View LM27313XQMFX/NOPB on WIN SOURCE](#)

 [Texas Instruments](#) Information

## Optimize Your Supply Chain with WIN SOURCE Solutions

-  Global Sourcing Solution
-  Obsolete Management
-  Cost Control Management
-  Shortage Management
-  Alternative Solution
-  Excess Inventory Management