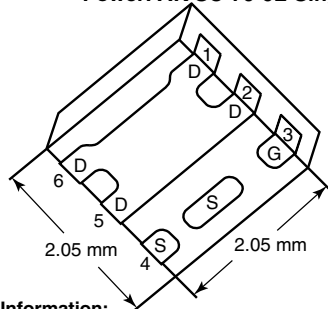

P-Channel 20 V (D-S) MOSFET

PRODUCT SUMMARY			
V _{DS} (V)	R _{DS(on)} (Ω) (Max.)	I _D (A) ^a	Q _g (Typ.)
- 20	0.0165 at V _{GS} = - 4.5 V	- 28	26.7 nC
	0.0180 at V _{GS} = - 3.7 V	- 27	
	0.0235 at V _{GS} = - 2.5 V	- 23	
	0.0420 at V _{GS} = - 1.8 V	- 6	

PowerPAK SC-70-6L-Single

Ordering Information:

SiA439EDJ-T1-GE3 (Lead (Pb)-free and Halogen-free)

FEATURES

- TrenchFET® Power MOSFET
- Thermally Enhanced PowerPAK® SC-70 Package
 - Small Footprint Area
 - Low On-Resistance
- 100 % R_g and UIS Tested
- Typical ESD Protection: 4000 V (HBM)
- Material categorization: For definitions of compliance please see www.vishay.com/doc?99912

RoHS
 COMPLIANT
 HALOGEN
FREE
APPLICATIONS

- Portable Devices such as Smart Phones, Tablet PCs and Mobile Computing
 - Battery Switch
 - Load Switch
 - Power Management

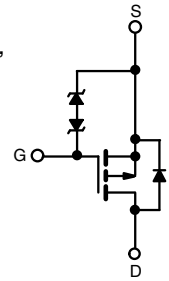

P-Channel MOSFET

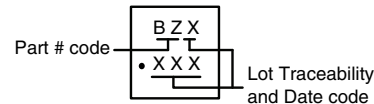
Marking Code

ABSOLUTE MAXIMUM RATINGS (T _C = 25 °C, unless otherwise noted)			
Parameter	Symbol	Limit	Unit
Drain-Source Voltage	V _{DS}	- 20	V
Gate-Source Voltage	V _{GS}	± 8	
Continuous Drain Current (T _J = 150 °C)	I _D	T _C = 25 °C	- 28
		T _C = 70 °C	- 22
		T _A = 25 °C	- 12 ^{b, c}
		T _A = 70 °C	- 9.5 ^{b, c}
Pulsed Drain Current (t = 300 μs)	I _{DM}	- 60	A
Continuous Source-Drain Diode Current	I _S	T _C = 25 °C	
		T _A = 25 °C	- 2.9 ^{b, c}
Single Avalanche Current	I _{AS}	- 11	mJ
Single Avalanche Energy	E _{AS}	5.8	
Maximum Power Dissipation	P _D	T _C = 25 °C	19
		T _C = 70 °C	12
		T _A = 25 °C	3.5 ^{b, c}
		T _A = 70 °C	2.2 ^{b, c}
Operating Junction and Storage Temperature Range	T _J , T _{stg}	- 50 to 150	°C
Soldering Recommendations (Peak Temperature) ^{d, e}		260	

THERMAL RESISTANCE RATINGS					
Parameter	Symbol	Typical	Maximum	Unit	
Maximum Junction-to-Ambient ^{b, f}	R _{thJA}	28	36	°C/W	
Maximum Junction-to-Case (Drain)	R _{thJC}	5.3	6.5		

Notes

- T_C = 25 °C.
- Surface mounted on 1" x 1" FR4 board.
- t = 5 s.
- See solder profile (www.vishay.com/doc?73257). The PowerPAK SC-70 is a leadless package. The end of the lead terminal is exposed copper (not plated) as a result of the singulation process in manufacturing. A solder fillet at the exposed copper tip cannot be guaranteed and is not required to ensure adequate bottom side solder interconnection.
- Rework conditions: manual soldering with a soldering iron is not recommended for leadless components.
- Maximum under steady state conditions is 80 °C/W.



SPECIFICATIONS ($T_J = 25\text{ }^\circ\text{C}$, unless otherwise noted)						
Parameter	Symbol	Test Conditions	Min.	Typ.	Max.	Unit
Static						
Drain-Source Breakdown Voltage	V_{DS}	$V_{GS} = 0\text{ V}, I_D = -250\text{ }\mu\text{A}$	-20			V
V_{DS} Temperature Coefficient	$\Delta V_{DS}/T_J$	$I_D = -250\text{ }\mu\text{A}$		-13		mV/ $^\circ\text{C}$
$V_{GS(th)}$ Temperature Coefficient	$\Delta V_{GS(th)}/T_J$		2.9			
Gate-Source Threshold Voltage	$V_{GS(th)}$	$V_{DS} = V_{GS}, I_D = -250\text{ }\mu\text{A}$	-0.4		-1	V
Gate-Source Leakage	I_{GSS}	$V_{DS} = 0\text{ V}, V_{GS} = \pm 8\text{ V}$			± 2	μA
		$V_{DS} = 0\text{ V}, V_{GS} = \pm 4.5\text{ V}$			± 0.5	
Zero Gate Voltage Drain Current	I_{DSS}	$V_{DS} = -20\text{ V}, V_{GS} = 0\text{ V}$			-1	
		$V_{DS} = -20\text{ V}, V_{GS} = 0\text{ V}, T_J = 55\text{ }^\circ\text{C}$			-10	
On-State Drain Current ^a	$I_{D(on)}$	$V_{DS} \leq -5\text{ V}, V_{GS} = -4.5\text{ V}$	-10			A
Drain-Source On-State Resistance ^a	$R_{DS(on)}$	$V_{GS} = -4.5\text{ V}, I_D = -5\text{ A}$		0.0130	0.0165	Ω
		$V_{GS} = -3.7\text{ V}, I_D = -5\text{ A}$		0.0140	0.0180	
		$V_{GS} = -2.5\text{ V}, I_D = -4\text{ A}$		0.0185	0.0235	
		$V_{GS} = -1.8\text{ V}, I_D = -2\text{ A}$		0.0300	0.0420	
Forward Transconductance ^a	g_{fs}	$V_{GS} = -10\text{ V}, I_D = -5\text{ A}$		24		S
Dynamic^b						
Input Capacitance	C_{iss}	$V_{DS} = -10\text{ V}, V_{GS} = 0\text{ V}, f = 1\text{ MHz}$		2410		pF
Output Capacitance	C_{oss}		265			
Reverse Transfer Capacitance	C_{rss}		245			
Total Gate Charge	Q_g	$V_{DS} = -10\text{ V}, V_{GS} = -8\text{ V}, I_D = -12\text{ A}$		45.5	69	nC
Gate-Source Charge	Q_{gs}	$V_{DS} = -10\text{ V}, V_{GS} = -4.5\text{ V}, I_D = -12\text{ A}$		26.7	40	
Gate-Drain Charge	Q_{gd}			4.5		
Gate Resistance	R_g		$f = 1\text{ MHz}$	1.8	9	
Turn-On Delay Time	$t_{d(on)}$	$V_{DD} = -10\text{ V}, R_L = 1\text{ }\Omega$ $I_D \cong -10\text{ A}, V_{GEN} = -4.5\text{ V}, R_g = 1\text{ }\Omega$		25	50	ns
Rise Time	t_r			20	40	
Turn-Off Delay Time	$t_{d(off)}$			95	190	
Fall Time	t_f			25	50	
Turn-On Delay Time	$t_{d(on)}$	$V_{DD} = -10\text{ V}, R_L = 1\text{ }\Omega$ $I_D \cong -10\text{ A}, V_{GEN} = -8\text{ V}, R_g = 1\text{ }\Omega$		10	20	
Rise Time	t_r			10	20	
Turn-Off Delay Time	$t_{d(off)}$			120	240	
Fall Time	t_f			25	50	
Drain-Source Body Diode Characteristics						
Continuous Source-Drain Diode Current	I_S	$T_C = 25\text{ }^\circ\text{C}$			-16	A
Pulse Diode Forward Current	I_{SM}				-60	
Body Diode Voltage	V_{SD}	$I_S = -10\text{ A}, V_{GS} = 0\text{ V}$		-0.75	-1.2	V
Body Diode Reverse Recovery Time	t_{rr}	$I_F = -10\text{ A}, di/dt = 100\text{ A}/\mu\text{s}, T_J = 25\text{ }^\circ\text{C}$		16	35	ns
Body Diode Reverse Recovery Charge	Q_{rr}			7	15	nC
Reverse Recovery Fall Time	t_a			7		ns
Reverse Recovery Rise Time	t_b			9		

Notes

- a. Pulse test; pulse width $\leq 300\text{ }\mu\text{s}$, duty cycle $\leq 2\%$.
- b. Guaranteed by design, not subject to production testing.

Stresses beyond those listed under "Absolute Maximum Ratings" may cause permanent damage to the device. These are stress ratings only, and functional operation of the device at these or any other conditions beyond those indicated in the operational sections of the specifications is not implied. Exposure to absolute maximum rating conditions for extended periods may affect device reliability.



TYPICAL CHARACTERISTICS (25 °C, unless otherwise noted)

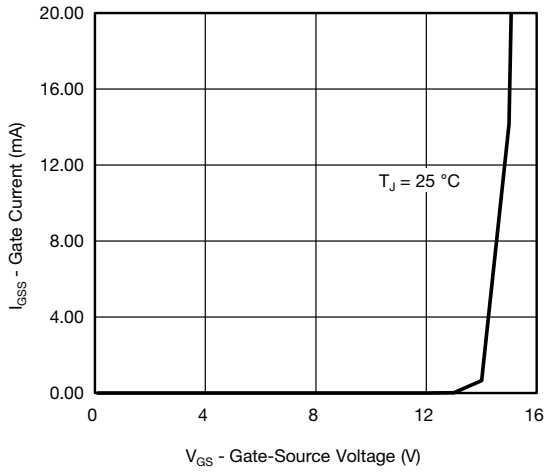

Gate Current vs. Gate-Source Voltage

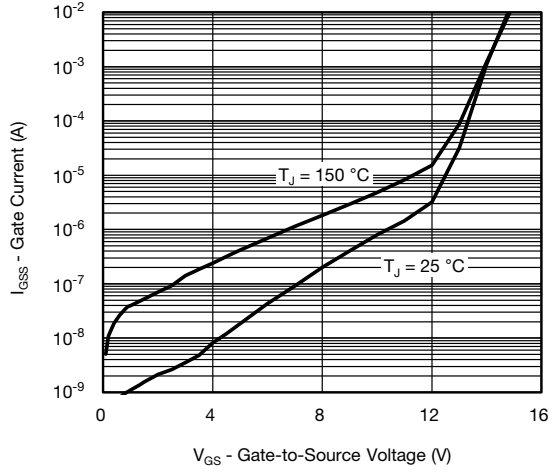

Gate Current vs. Gate-to-Source Voltage

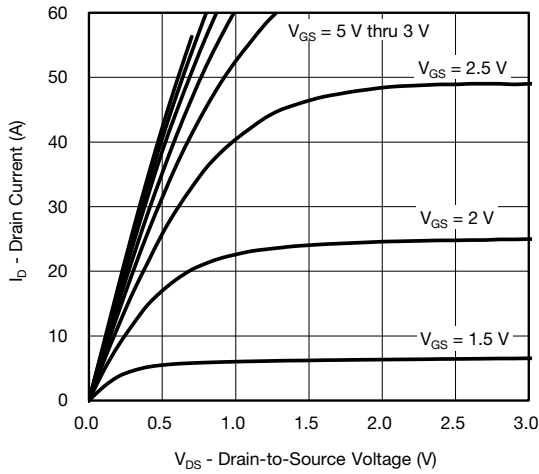

Output Characteristics

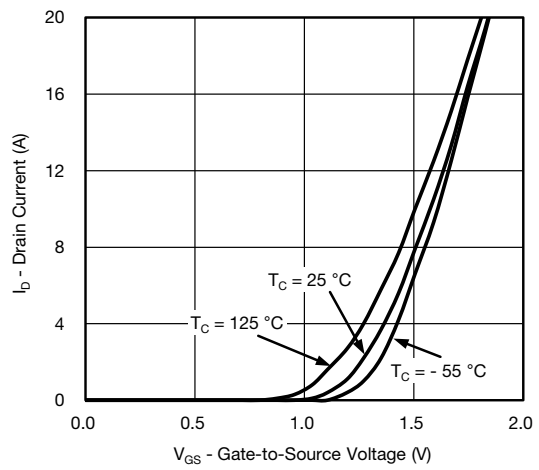

Transfer Characteristics

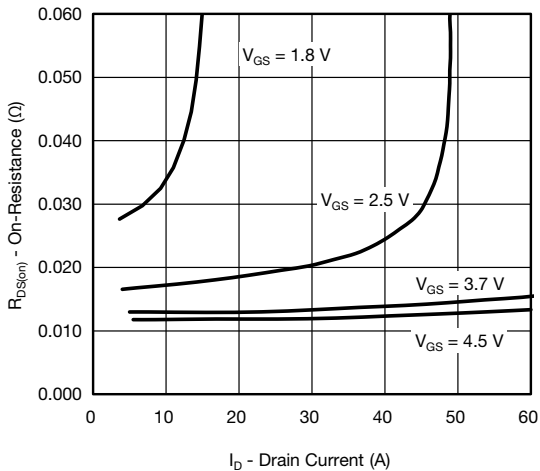

On-Resistance vs. Drain Current and Gate Voltage

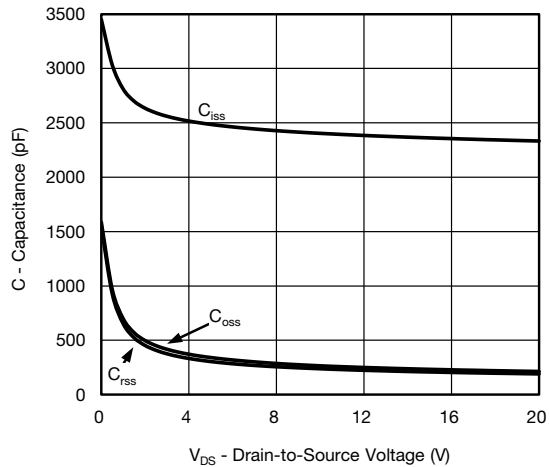

Capacitance



TYPICAL CHARACTERISTICS (25 °C, unless otherwise noted)

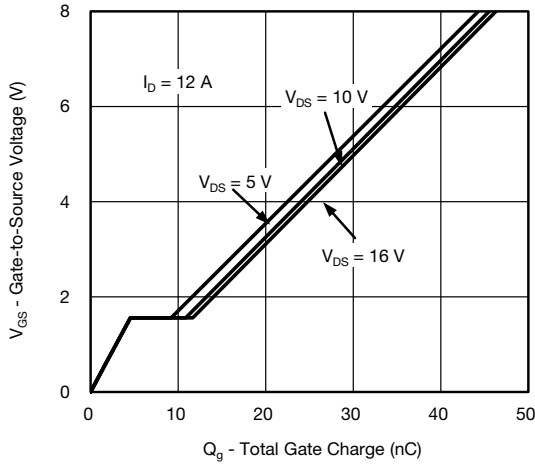

Gate Charge

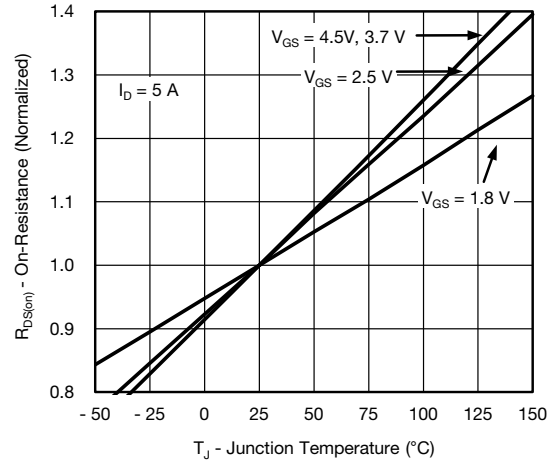

On-Resistance vs. Junction Temperature

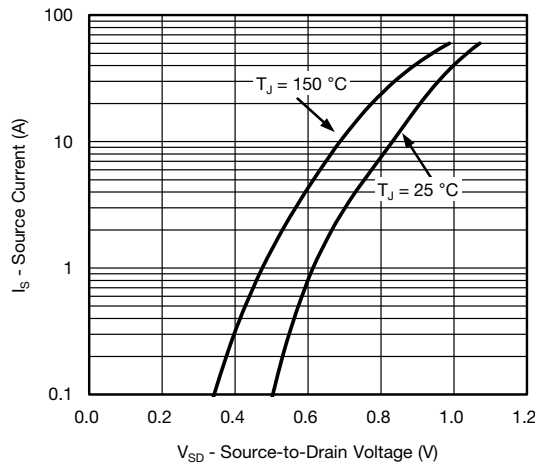

Source-Drain Diode Forward Voltage

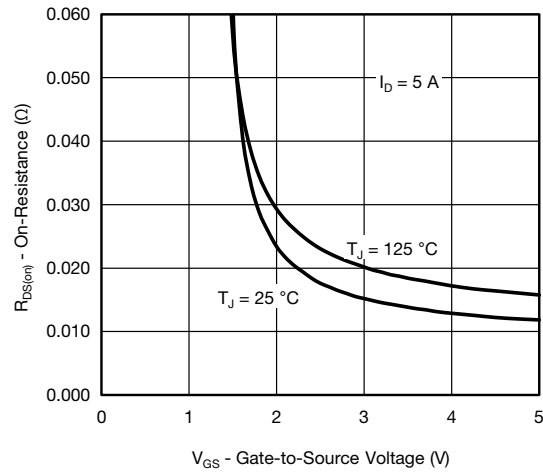

On-Resistance vs. Gate-to-Source Voltage

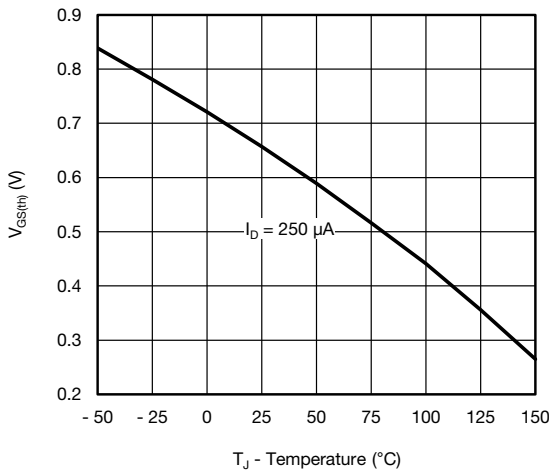

Threshold Voltage

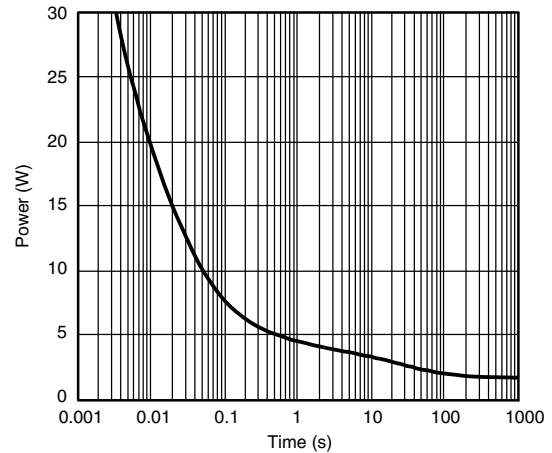

Single Pulse Power, Junction-to-Ambient

TYPICAL CHARACTERISTICS (25 °C, unless otherwise noted)

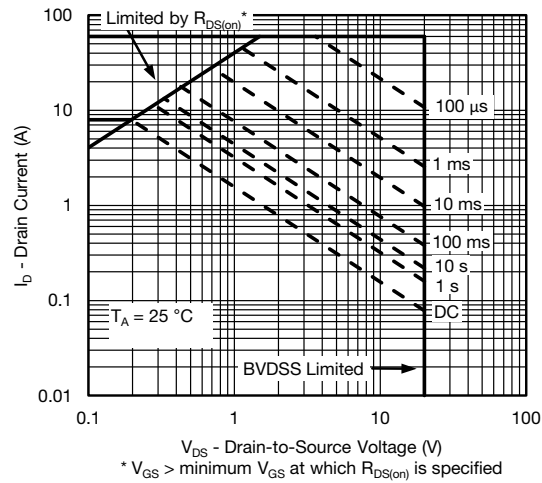

Safe Operating Area, Junction-to-Ambient

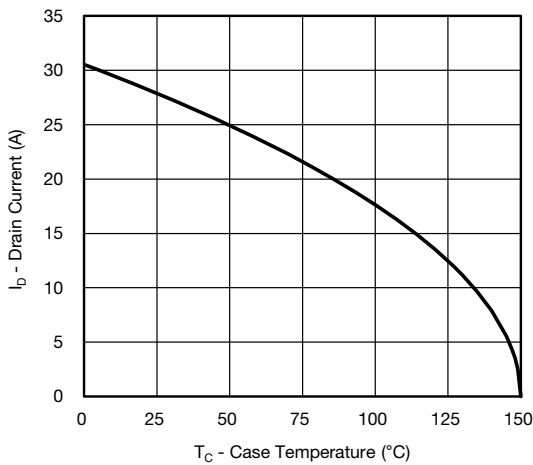

Current Derating*

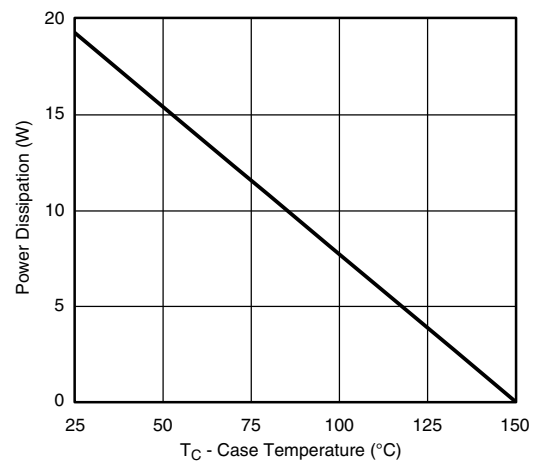

Power Derating

* The power dissipation P_D is based on $T_{J(max.)} = 150\text{ °C}$, using junction-to-case thermal resistance, and is more useful in settling the upper dissipation limit for cases where additional heatsinking is used. It is used to determine the current rating, when this rating falls below the package limit.



TYPICAL CHARACTERISTICS (25 °C, unless otherwise noted)

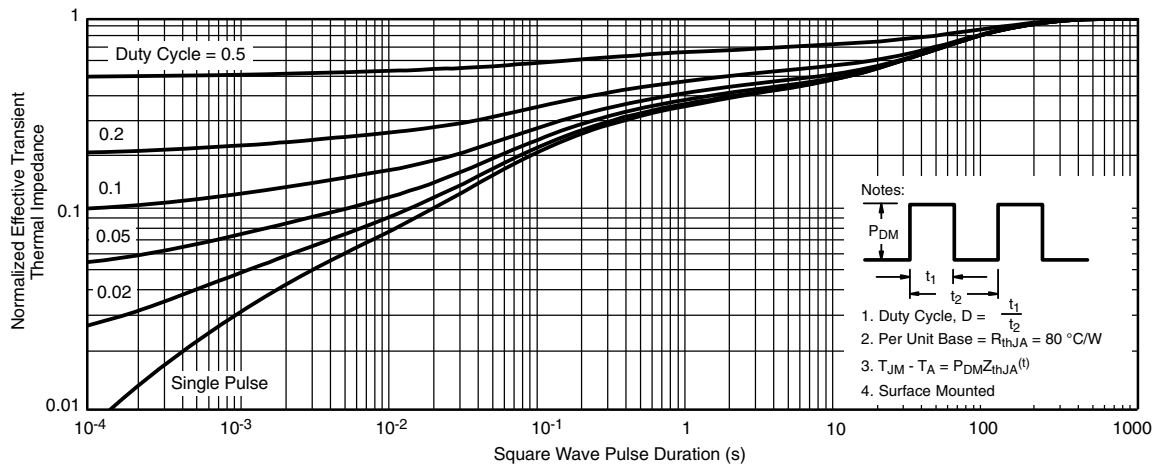

Normalized Thermal Transient Impedance, Junction-to-Ambient

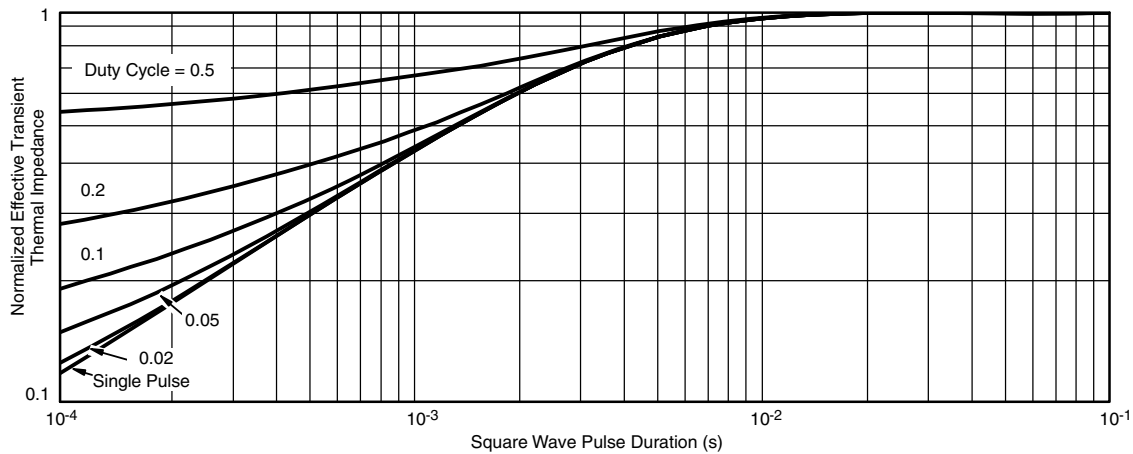

Normalized Thermal Transient Impedance, Junction-to-Case

Vishay Siliconix maintains worldwide manufacturing capability. Products may be manufactured at one of several qualified locations. Reliability data for Silicon Technology and Package Reliability represent a composite of all qualified locations. For related documents such as package/tape drawings, part marking, and reliability data, see www.vishay.com/ppg?62819.



PowerPAK® SC70-6L

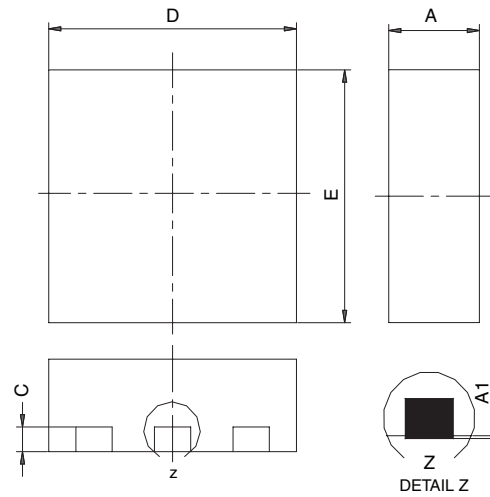
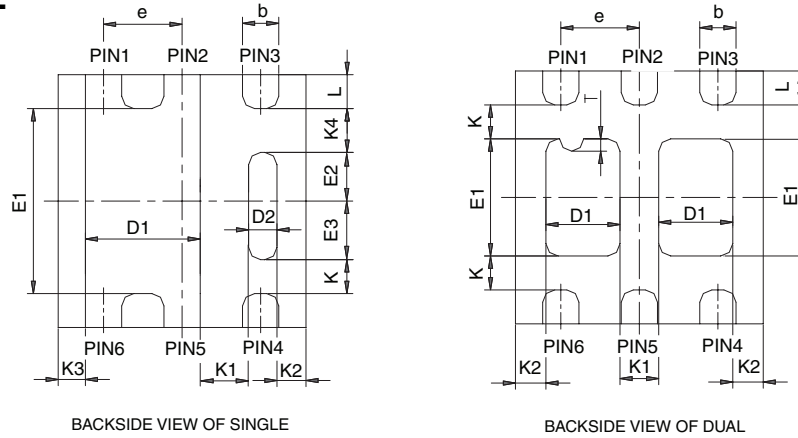

- Notes:
 1. All dimensions are in millimeters
 2. Package outline exclusive of mold flash and metal burr
 3. Package outline inclusive of plating

DIM	SINGLE PAD						DUAL PAD					
	MILLIMETERS			INCHES			MILLIMETERS			INCHES		
	Min	Nom	Max	Min	Nom	Max	Min	Nom	Max	Min	Nom	Max
A	0.675	0.75	0.80	0.027	0.030	0.032	0.675	0.75	0.80	0.027	0.030	0.032
A1	0	-	0.05	0	-	0.002	0	-	0.05	0	-	0.002
b	0.23	0.30	0.38	0.009	0.012	0.015	0.23	0.30	0.38	0.009	0.012	0.015
C	0.15	0.20	0.25	0.006	0.008	0.010	0.15	0.20	0.25	0.006	0.008	0.010
D	1.98	2.05	2.15	0.078	0.081	0.085	1.98	2.05	2.15	0.078	0.081	0.085
D1	0.85	0.95	1.05	0.033	0.037	0.041	0.513	0.613	0.713	0.020	0.024	0.028
D2	0.135	0.235	0.335	0.005	0.009	0.013						
E	1.98	2.05	2.15	0.078	0.081	0.085	1.98	2.05	2.15	0.078	0.081	0.085
E1	1.40	1.50	1.60	0.055	0.059	0.063	0.85	0.95	1.05	0.033	0.037	0.041
E2	0.345	0.395	0.445	0.014	0.016	0.018						
E3	0.425	0.475	0.525	0.017	0.019	0.021						
e	0.65 BSC			0.026 BSC			0.65 BSC			0.026 BSC		
K	0.275 TYP			0.011 TYP			0.275 TYP			0.011 TYP		
K1	0.400 TYP			0.016 TYP			0.320 TYP			0.013 TYP		
K2	0.240 TYP			0.009 TYP			0.252 TYP			0.010 TYP		
K3	0.225 TYP			0.009 TYP								
K4	0.355 TYP			0.014 TYP								
L	0.175	0.275	0.375	0.007	0.011	0.015	0.175	0.275	0.375	0.007	0.011	0.015
T							0.05	0.10	0.15	0.002	0.004	0.006

ECN: C-07431 – Rev. C, 06-Aug-07
 DWG: 5934

RECOMMENDED PAD LAYOUT FOR PowerPAK® SC70-6L Single

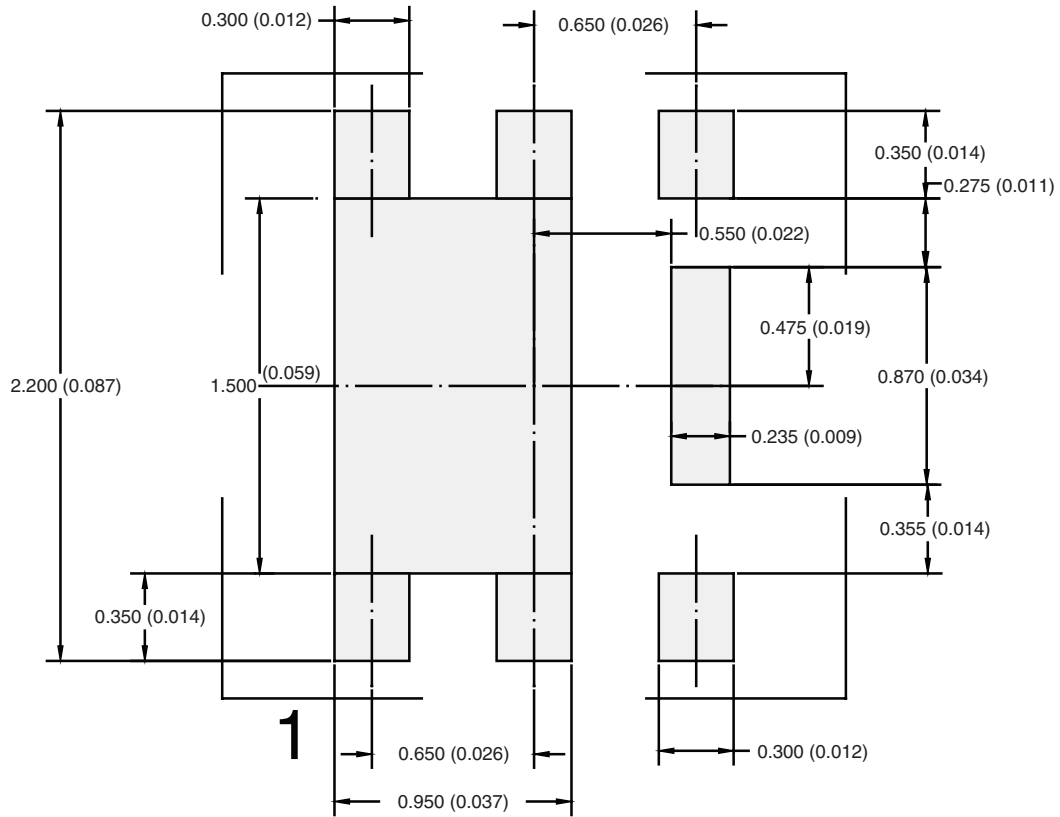

Dimensions in mm/(Inches)

[Return to Index](#)



Disclaimer

ALL PRODUCT, PRODUCT SPECIFICATIONS AND DATA ARE SUBJECT TO CHANGE WITHOUT NOTICE TO IMPROVE RELIABILITY, FUNCTION OR DESIGN OR OTHERWISE.

Vishay Intertechnology, Inc., its affiliates, agents, and employees, and all persons acting on its or their behalf (collectively, "Vishay"), disclaim any and all liability for any errors, inaccuracies or incompleteness contained in any datasheet or in any other disclosure relating to any product.

Vishay makes no warranty, representation or guarantee regarding the suitability of the products for any particular purpose or the continuing production of any product. To the maximum extent permitted by applicable law, Vishay disclaims (i) any and all liability arising out of the application or use of any product, (ii) any and all liability, including without limitation special, consequential or incidental damages, and (iii) any and all implied warranties, including warranties of fitness for particular purpose, non-infringement and merchantability.

Statements regarding the suitability of products for certain types of applications are based on Vishay's knowledge of typical requirements that are often placed on Vishay products in generic applications. Such statements are not binding statements about the suitability of products for a particular application. It is the customer's responsibility to validate that a particular product with the properties described in the product specification is suitable for use in a particular application. Parameters provided in datasheets and / or specifications may vary in different applications and performance may vary over time. All operating parameters, including typical parameters, must be validated for each customer application by the customer's technical experts. Product specifications do not expand or otherwise modify Vishay's terms and conditions of purchase, including but not limited to the warranty expressed therein.

Except as expressly indicated in writing, Vishay products are not designed for use in medical, life-saving, or life-sustaining applications or for any other application in which the failure of the Vishay product could result in personal injury or death. Customers using or selling Vishay products not expressly indicated for use in such applications do so at their own risk. Please contact authorized Vishay personnel to obtain written terms and conditions regarding products designed for such applications.

No license, express or implied, by estoppel or otherwise, to any intellectual property rights is granted by this document or by any conduct of Vishay. Product names and markings noted herein may be trademarks of their respective owners.

Looking for pricing, stock, or lifecycle information?

Click below to explore more details on WIN SOURCE:

 [View SIA439EDJ-T1-GE3 on WIN SOURCE](#)

 [Vishay Information](#)

Optimize Your Supply Chain with WIN SOURCE Solutions

-  Global Sourcing Solution
-  Obsolete Management
-  Cost Control Management
-  Shortage Management
-  Alternative Solution
-  Excess Inventory Management