



**THE DATASHEET OF
DG2037DQ-T1-E3**



Low-Voltage, Low r_{ON} , Dual SPST Analog Switch

DESCRIPTION

The DG2037/2038/2039 are dual single-pole/single-throw monolithic CMOS analog switch designed for high performance switching of analog signals. Combining low power, fast switching, low on-resistance ($r_{DS(on)}$: 3.0Ω at 2.7 V) and small physical size, the DG2037/2038/2039 are ideal for portable and battery powered applications requiring high performance and efficient use of board space.

The DG2037/2038/2039 are built on Vishay Siliconix's new high density low voltage process. An epitaxial layer prevents latchup.

Each switch conducts equally well in both directions when on, and blocks up to the power supply level when off.

FEATURES

- Low Voltage Operation (1.8 V to 5.5 V)
- Low On-Resistance - $r_{DS(on)}$: 3.0Ω
- Fast Switching - 12 ns
- Low Charge Injection - Q_{INJ} : 10 pC
- Low Power Consumption
- TTL/CMOS Compatible
- SOT23-8 and MSOP-8 Packages

BENEFITS

- Reduced Power Consumption
- Simple Logic Interface
- High Accuracy
- Reduce Board Space

APPLICATIONS

- Cellular Phones
- Communication Systems
- Portable Test Equipment
- Battery Operated Systems
- Sample and Hold Circuits

FUNCTIONAL BLOCK DIAGRAM AND PIN CONFIGURATION - DG2037

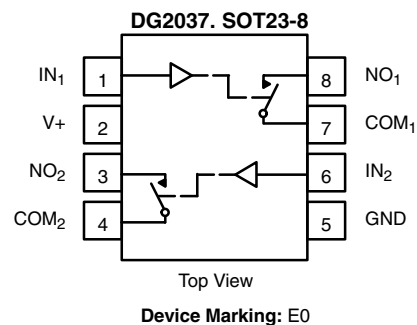
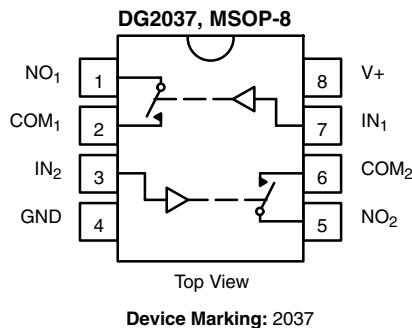

TRUTH TABLE - DG2037

Logic	Switch
0	Off
1	On

DG2037/2038/2039

Vishay Siliconix



FUNCTIONAL BLOCK DIAGRAM AND PIN CONFIGURATION - DG2038/DG2039

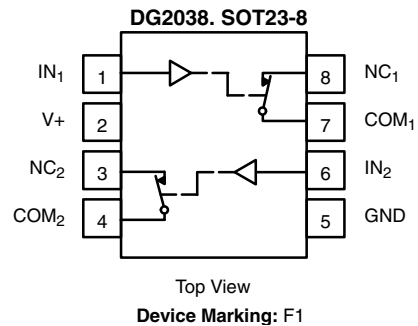
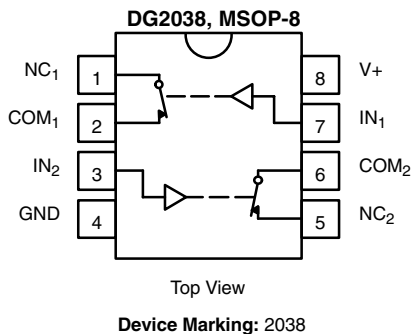

TRUTH TABLE - DG2038	
Logic	Switch
0	On
1	Off

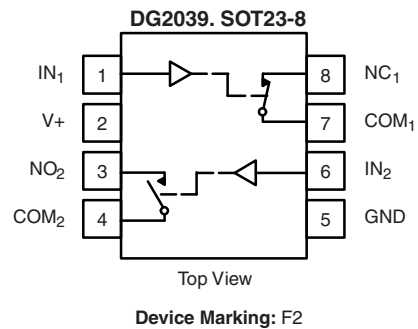
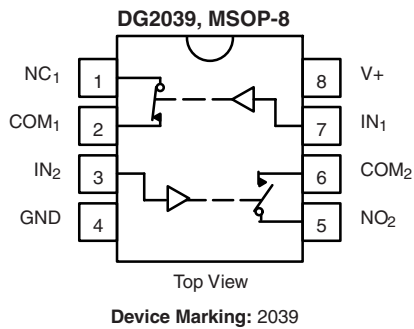

TRUTH TABLE - DG2039		
Logic	Switch-1	Switch-2
0	On	Off
1	Off	On

ORDERING INFORMATION		
Temp Range	Package	Part Number
- 40 to 85 °C	MSOP-8	DG2037DQ
		DG2038DQ
		DG2039DQ
	SOT23-8	DG2037DS
		DG2038DS
		DG2039DS



ABSOLUTE MAXIMUM RATINGS			
Parameter		Limit	Unit
Referenced V+ to GND		- 0.3 to 6.0	V
IN, COM, NC, NO ^a		- 0.3 to (V+ + 0.3)	
Continuous Current (Any Terminal)		± 50	mA
Peak Current (Pulsed at 1 ms, 10 % duty cycle)		± 200	
Storage Temperature (D Suffix)		- 65 to 150	°C
Power Dissipation (Packages) ^b	MSOP-8 ^c	320	mW
	SOT23-8 ^c	515	

Notes:

a. Signals on NC, NO, or COM or IN exceeding V+ will be clamped by internal diodes. Limit forward diode current to maximum current ratings.

b. All leads welded or soldered to PC Board.

c. Derate 6.5 mW/°C above 25 °C.

SPECIFICATIONS (V+ = 3.0 V)							
Parameter	Symbol	Test Conditions Otherwise Unless Specified V+ = 3 V, ± 10 %, V _{IN} = 0.4 or 1.5 V ^e	Temp ^a	Limits - 40 to 85 °C			Unit
				Min ^b	Typ ^c	Max ^b	
Analog Switch							
Analog Signal Range ^d	V _{NO} , V _{NC} V _{COM}		Full	0		V+	V
On-Resistance	r _{ON}	V+ = 2.7 V, V _{COM} = 1.5 V, I _{NO} , I _{NC} = 10 mA	Room Full		3	6 7	Ω
r _{ON} Flatness ^d	r _{ON} Flatness	V+ = 2.7 V, V _{COM} = 1.5 to V+, I _{NO} , I _{NC} = 10 mA	Room		0.5		
r _{ON} Match ^d	r _{ON} Match	V+ = 2.7 V, V _D = 1.5 to V+, I _D = 10 mA	Room		0.3		
Switch Off Leakage Current	I _{NO(off)} I _{NC(off)}	V+ = 3.3 V V _{NO} , V _{NC} = 1 V/3 V, V _{COM} = 3 V/1 V	Room Full	- 1 - 10		1 10	nA
	I _{COM(off)}		Room Full	- 1 - 10		1 10	
Channel-On Leakage Current	I _{COM(on)}	V+ = 3.3 V, V _{NO} , V _{NC} = V _{COM} = 1 V/3 V	Room Full	- 1 - 10		1 10	
Digital Control							
Input High Voltage	V _{INH}		Full	1.5			V
Input Low Voltage	V _{INL}		Full			0.4	
Input Capacitance ^d	C _{in}	f = 1 MHz	Full		8		pF
Input Current	I _{INL} or I _{INH}	V _{IN} = 0 or V+	Full	- 1		1	μA
Dynamic Characteristics							
Turn-On Time	t _{ON}	V _{NO} or V _{NC} = 2.0 V, R _L = 300 Ω, C _L = 35 pF Figures 1 and 2	Room Full		22	35 40	ns
Turn-Off Time	t _{OFF}		Room Full		17	31 35	
Charge Injection ^d	Q _{INJ}	C _L = 1 nF, V _{GEN} = 0 V, R _{GEN} = 0 Ω, Figure 3	Room		1		pC
Off-Isolation ^d	OIRR	R _L = 50 Ω, C _L = 5 pF, f = 1 MHz	Room		- 61		dB
Crosstalk ^d	X _{TALK}		Room		- 67		
Source-Off Capacitance ^d	C _{NC/NO(off)}	V _{IN} = 0 or V+, f = 1 MHz	Room		17		pF
Drain-Off Capacitance ^d	C _{COM(off)}		Room		19		
Channel-On Capacitance ^d	C _{ON}		Room		35		
Power Supply							
Power Supply Range	V+			2.7		3.3	V
Power Supply Current	I+	V _{IN} = 0 or V+			0.02	1.0	μA
Power Consumption	P _C						3.3



SPECIFICATIONS (V+ = 5.0 V)							
Parameter	Symbol	Test Conditions Otherwise Unless Specified V+ = 5 V, ± 10 %, V _{IN} = 0.8 or 2.4 V ^e	Temp ^a	Limits - 40 to 85 °C			Unit
				Min ^b	Typ ^c	Max ^b	
Analog Switch							
Analog Signal Range ^d	V _{NO} , V _{NC} V _{COM}		Full	0		V+	V
On-Resistance	r _{ON}	V+ = 4.5 V, V _{COM} = 2.5 V, I _{NO} , I _{NC} = 10 mA	Room Full		2.5 1.6	5 6	Ω
r _{ON} Flatness ^d	r _{ON} Flatness	V+ = 4.5 V, V _{COM} = 2.5 to V+, I _{NO} , I _{NC} = 10 mA	Room		0.4		
r _{ON} Match ^d	r _{ON} Match	V+ = 4.5 V, I _D = 10 mA, V _{COM} = 2.5 V	Room		0.2		
Switch Off Leakage Current	I _{NO(off)} I _{NC(off)}	V+ = 5.5 V V _{NO} , V _{NC} = 1 V/4.5 V, V _{COM} = 4.5 V/1 V	Room Full	- 1 - 10		1 10	nA
	I _{COM(off)}		Room Full	- 1 - 10		1 10	
Channel-On Leakage Current	I _{COM(on)}	V+ = 5.5 V V _{NO} , V _{NC} = V _{COM} = 1 V/4.5 V	Room Full	- 1 - 10		1 10	
Digital Control							
Input High Voltage	V _{INH}		Full	2.4			V
Input Low Voltage	V _{INL}		Full			0.8	
Input Capacitance	C _{in}	f = 1 MHz	Full		8		pF
Input Current	I _{INL} or I _{INH}	V _{IN} = 0 or V+	Full	- 1		1	μA
Dynamic Characteristics							
Turn-On Time ^d	t _{ON}	V _{NO} or V _{NC} = 3 V, R _L = 300 Ω, C _L = 35 pF Figures 1 and 2	Room Full		19	30 35	ns
Turn-Off Time ^d	t _{OFF}		Room Full		12	22 30	
Charge Injection ^d	Q _{INJ}	C _L = 1 nF, V _{GEN} = 0 V, R _{GEN} = 0 Ω, Figure 3	Room		1		pC
Off-Isolation ^d	OIRR	R _L = 50 Ω, C _L = 5 pF, f = 1 MHz	Room		- 61		dB
Crosstalk ^d	X _{TALK}		Room		- 67		
Source-Off Capacitance ^d	C _{NC/NO(off)}	V _{IN} = 0 or V+, f = 1 MHz	Room		15		pF
Drain-Off Capacitance ^d	C _{COM(off)}		Room		17		
Channel-On Capacitance ^d	C _{ON}		Room		35		
Power Supply							
Power Supply Range	V+			4.5		5.5	V
Power Supply Current	I+	V _{IN} = 0 or V+			0.02	1.0	μA
Power Consumption	P _C						5.5

Notes:

- Room = 25 °C, Full = as determined by the operating suffix.
- The algebraic convention whereby the most negative value is a minimum and the most positive a maximum, is used in this data sheet.
- Typical values are for design aid only, not guaranteed nor subject to production testing.
- Guarantee by design, nor subjected to production test.
- V_{IN} = input voltage to perform proper function.
- Not production tested.

Stresses beyond those listed under "Absolute Maximum Ratings" may cause permanent damage to the device. These are stress ratings only, and functional operation of the device at these or any other conditions beyond those indicated in the operational sections of the specifications is not implied. Exposure to absolute maximum rating conditions for extended periods may affect device reliability.



TYPICAL CHARACTERISTICS 25 °C, unless otherwise noted

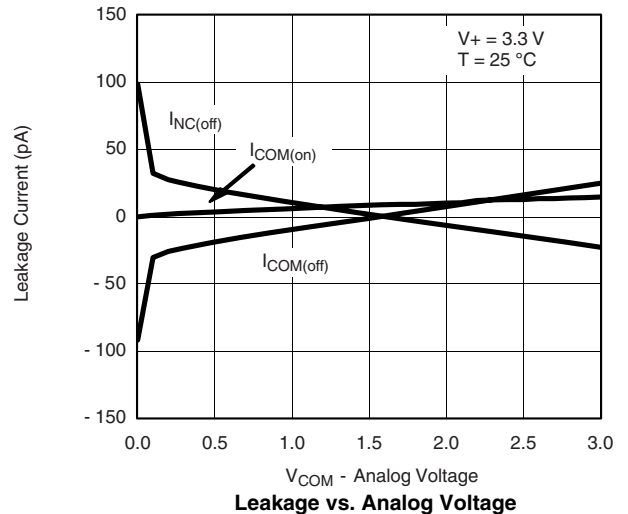
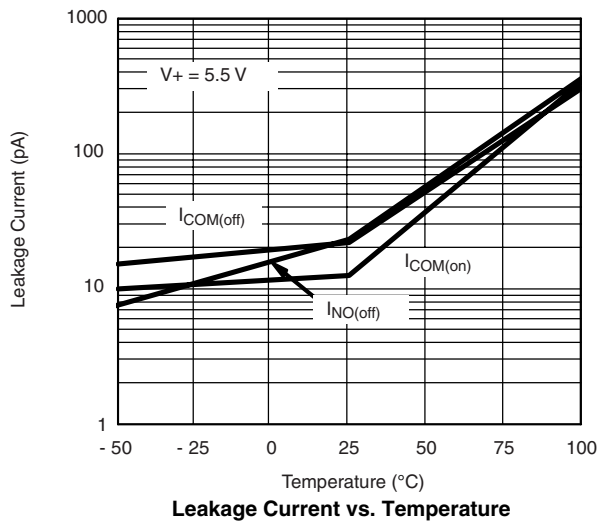
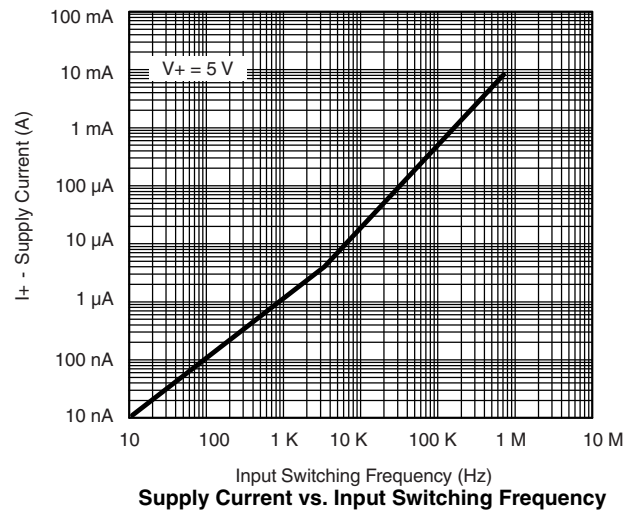
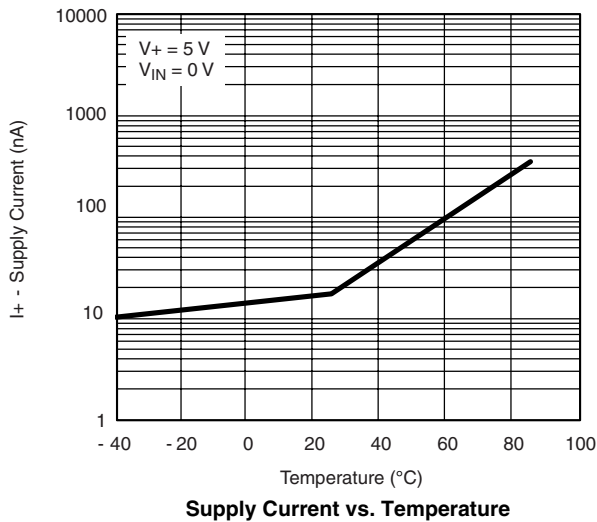
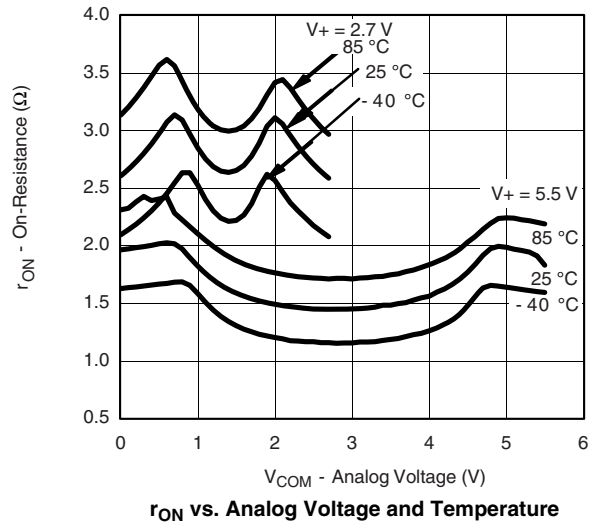
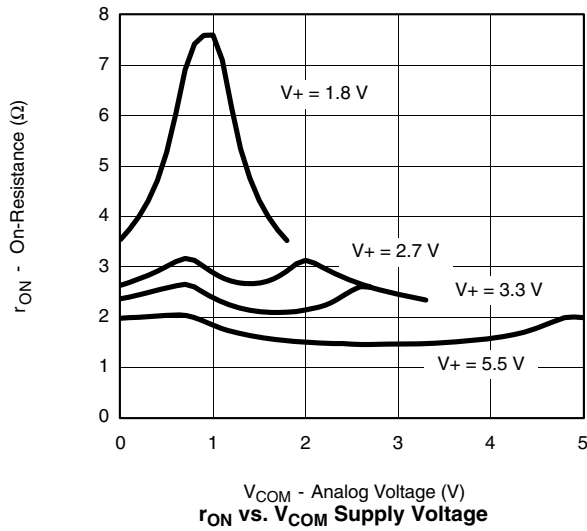



Vishay Siliconix

TYPICAL CHARACTERISTICS 25 °C, unless otherwise noted

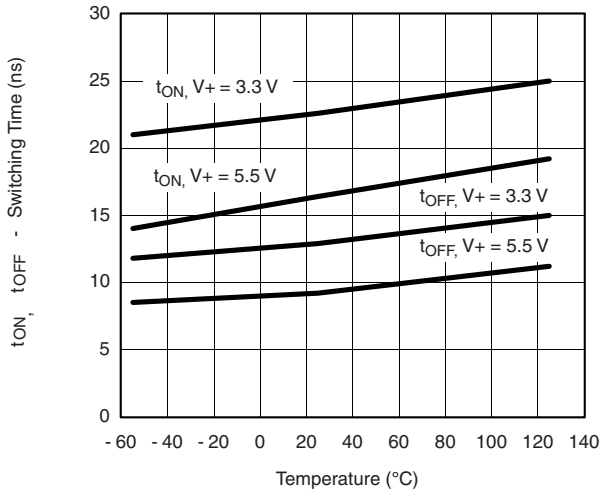

Switching Time vs. Temperature and Supply Voltage

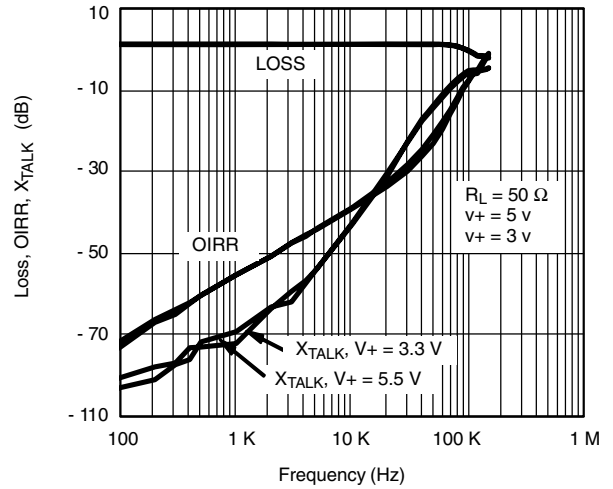

Insertion Loss, Off-Isolation Crosstalk vs. Frequency

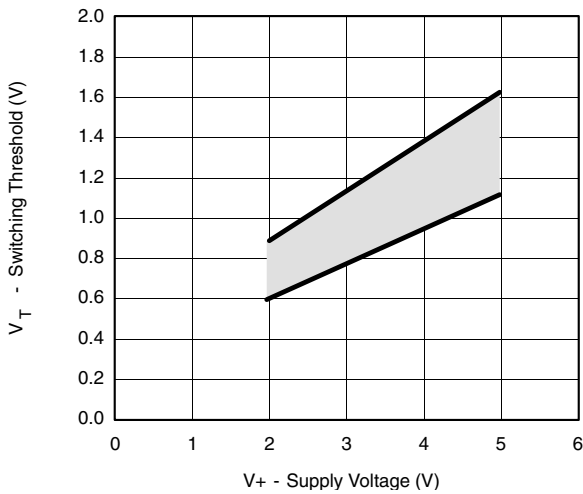

Switching Threshold vs. Supply Voltage

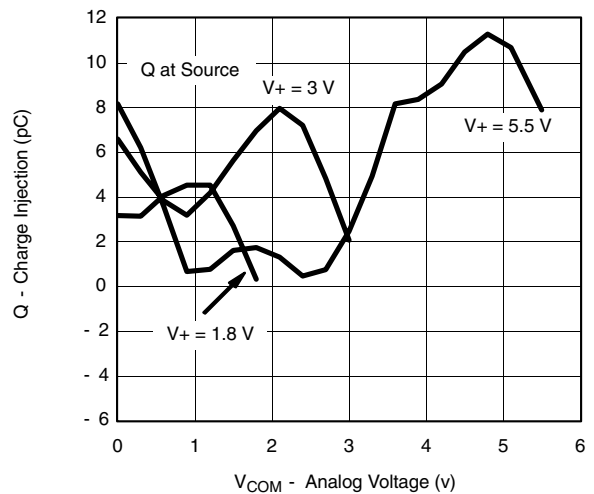

Charge Injection vs. Analog Voltage

TEST CIRCUITS

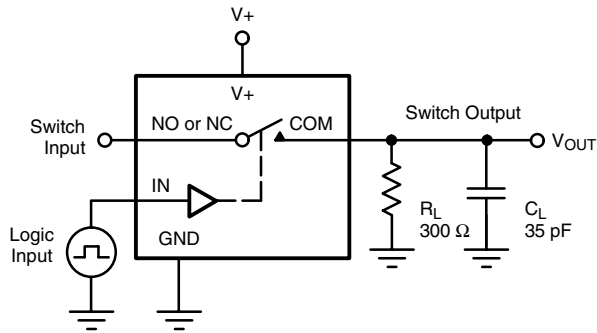

C_L (includes fixture and stray capacitance)

$$V_{OUT} = V_{COM} \left(\frac{R_L}{R_L + R_{ON}} \right)$$

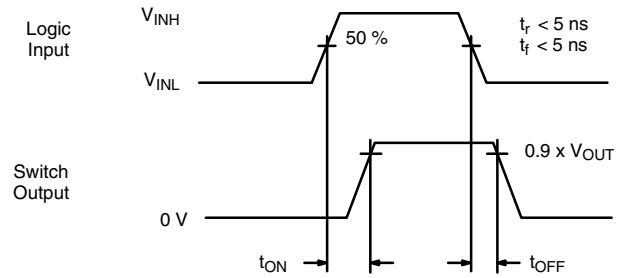

Logic "1" = Switch On
Logic input waveforms inverted for switches that have the opposite logic sense.

Figure 1. Switching Time

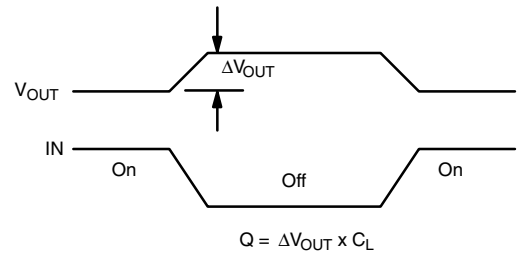
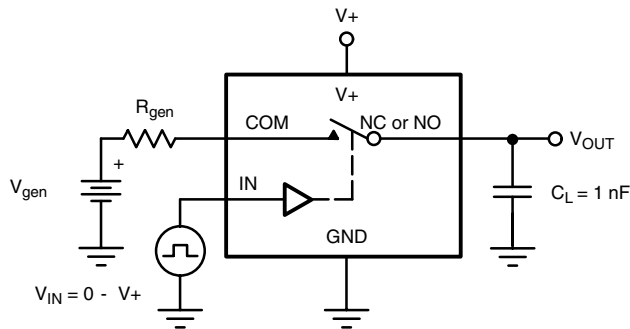

IN depends on switch configuration: input polarity determined by sense of switch.

Figure 2. Charge Injection

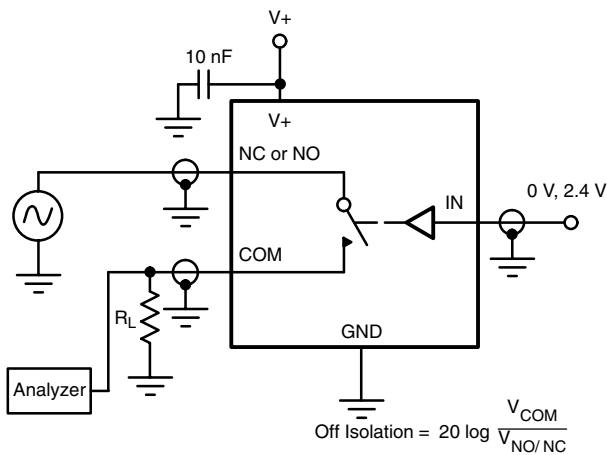

Figure 3. Off-Isolation

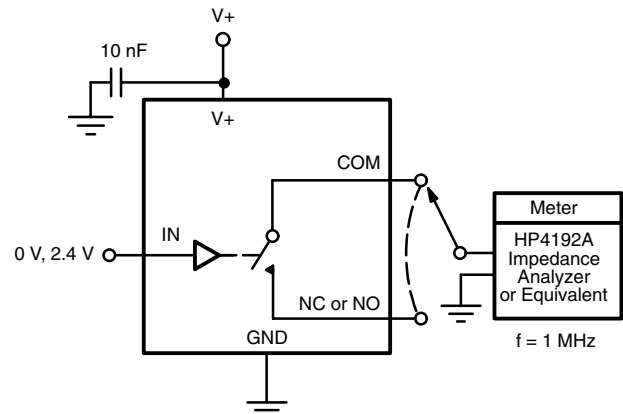

Figure 4. Channel Off/On Capacitance

Vishay Siliconix maintains worldwide manufacturing capability. Products may be manufactured at one of several qualified locations. Reliability data for Silicon Technology and Package Reliability represent a composite of all qualified locations. For related documents such as package/tape drawings, part marking, and reliability data, see <http://www.vishay.com/ppg?72359>.



Disclaimer

All product specifications and data are subject to change without notice.

Vishay Intertechnology, Inc., its affiliates, agents, and employees, and all persons acting on its or their behalf (collectively, "Vishay"), disclaim any and all liability for any errors, inaccuracies or incompleteness contained herein or in any other disclosure relating to any product.

Vishay disclaims any and all liability arising out of the use or application of any product described herein or of any information provided herein to the maximum extent permitted by law. The product specifications do not expand or otherwise modify Vishay's terms and conditions of purchase, including but not limited to the warranty expressed therein, which apply to these products.

No license, express or implied, by estoppel or otherwise, to any intellectual property rights is granted by this document or by any conduct of Vishay.

The products shown herein are not designed for use in medical, life-saving, or life-sustaining applications unless otherwise expressly indicated. Customers using or selling Vishay products not expressly indicated for use in such applications do so entirely at their own risk and agree to fully indemnify Vishay for any damages arising or resulting from such use or sale. Please contact authorized Vishay personnel to obtain written terms and conditions regarding products designed for such applications.

Product names and markings noted herein may be trademarks of their respective owners.

Looking for pricing, stock, or lifecycle information?

Click below to explore more details on WIN SOURCE:

 [View DG2037DQ-T1-E3 on WIN SOURCE](#)

 [Vishay Information](#)

Optimize Your Supply Chain with WIN SOURCE Solutions

-  Global Sourcing Solution
-  Obsolete Management
-  Cost Control Management
-  Shortage Management
-  Alternative Solution
-  Excess Inventory Management