



# THE DATASHEET OF BULB39D-1





## BULB39D

# HIGH VOLTAGE FAST-SWITCHING NPN POWER TRANSISTOR

- NPN TRANSISTOR
- HIGH VOLTAGE CAPABILITY
- MINIMUM LOT-TO-LOT SPREAD FOR RELIABLE OPERATION
- VERY HIGH SWITCHING SPEED
- HIGH RUGGEDNESS
- SURFACE-MOUNTING D<sup>2</sup>PAK (TO-263) POWER PACKAGE IN TAPE & REEL (Suffix "T4")

### APPLICATIONS

- ELECTRONIC TRANSFORMERS FOR HALOGEN LAMPS
- SWITCH MODE POWER SUPPLIES

### DESCRIPTION

The BULB39D is manufactured using high voltage Multi Epitaxial Planar technology to enhance switching speeds while maintaining wide RBSOA.

The BUL series is designed for use in electronics transformers for halogen lamps.

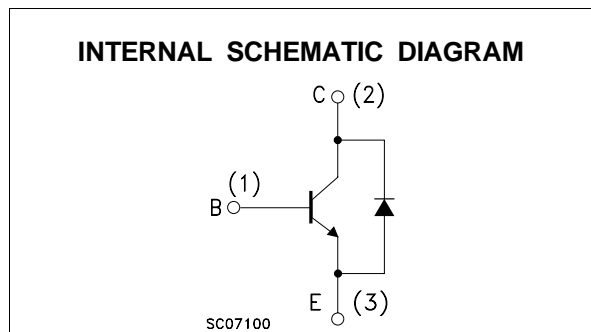
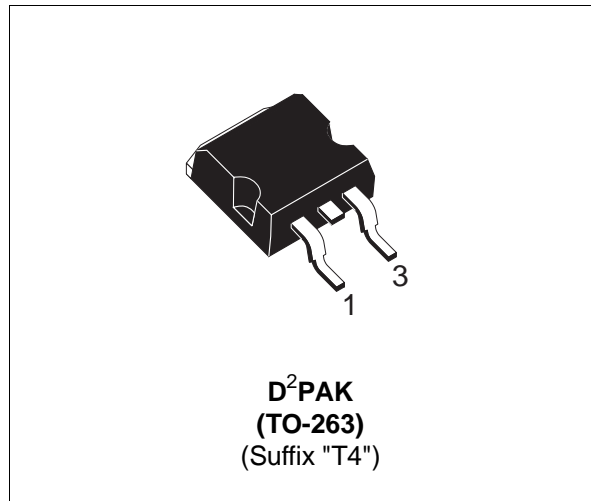

### ABSOLUTE MAXIMUM RATINGS

Symbol	Parameter	Value	Unit
$V_{CES}$	Collector-Emitter Voltage ( $V_{BE} = 0$ )	850	V
$V_{CEO}$	Collector-Emitter Voltage ( $I_B = 0$ )	450	V
$V_{EBO}$	Emitter-Base Voltage ( $I_C = 0$ )	9	V
$I_C$	Collector Current	4	A
$I_{CM}$	Collector Peak Current ( $t_p < 5$ ms)	8	A
$I_B$	Base Current	2	A
$I_{BM}$	Base Peak Current ( $t_p < 5$ ms)	4	A
$P_{tot}$	Total Dissipation at $T_c = 25$ °C	70	W
$T_{stg}$	Storage Temperature	-65 to 150	°C
$T_j$	Max. Operating Junction Temperature	150	°C

## BULB39D

### THERMAL DATA

R <sub>thj-case</sub>	Thermal Resistance Junction-Case	Max	1.78	°C/W
R <sub>thj-amb</sub>	Thermal Resistance Junction-Ambient	Max	70	°C/W

### ELECTRICAL CHARACTERISTICS (T<sub>case</sub> = 25 °C unless otherwise specified)

Symbol	Parameter	Test Conditions	Min.	Typ.	Max.	Unit
I <sub>CES</sub>	Collector Cut-off Current (V <sub>BE</sub> = 0)	V <sub>CE</sub> = 850 V V <sub>CE</sub> = 850 V T <sub>j</sub> = 125 °C			100 500	μA μA
I <sub>EBO</sub>	Emitter Cut-off Current (I <sub>C</sub> = 0)	V <sub>EB</sub> = 9 V			100	μA
V <sub>CEO(sus)*</sub>	Collector-Emitter Sustaining Voltage (I <sub>B</sub> = 0)	I <sub>C</sub> = 100 mA L = 25 mH	450			V
V <sub>CE(sat)*</sub>	Collector-Emitter Saturation Voltage	I <sub>C</sub> = 1 A I <sub>B</sub> = 0.2 A I <sub>C</sub> = 2.5 A I <sub>B</sub> = 0.5 A		0.13	0.5 1.1	V V
V <sub>BE(sat)*</sub>	Base-Emitter Saturation Voltage	I <sub>C</sub> = 1 A I <sub>B</sub> = 0.2 A I <sub>C</sub> = 2.5 A I <sub>B</sub> = 0.5 A			1.1 1.3	V V
h <sub>FE*</sub>	DC Current Gain	I <sub>C</sub> = 5 A V <sub>CE</sub> = 10 V I <sub>C</sub> = 10 mA V <sub>CE</sub> = 5 V	4 10			
V <sub>CEW</sub>	Maximum Collector Emitter Voltage Without Snubber	I <sub>C</sub> = 6 A R <sub>BB</sub> = 0 Ω V <sub>BB</sub> = -2.5 V L = 50 μH t <sub>p</sub> = 10 μs	450			V
t <sub>s</sub> t <sub>f</sub>	INDUCTIVE LOAD Storage Time Fall Time	I <sub>C</sub> = 2.5 A I <sub>B(on)</sub> = 0.5 A V <sub>BE(off)</sub> = -5 V R <sub>BB</sub> = 0 Ω V <sub>CL</sub> = 300 V L = 1 mH		0.7 50	1.5 100	μs ns
V <sub>f</sub>	Diode Forward Voltage	I <sub>C</sub> = 2 A			1.5	V

\* Pulsed: Pulse duration = 300 μs, duty cycle 1.5 %

Safe Operating Areas

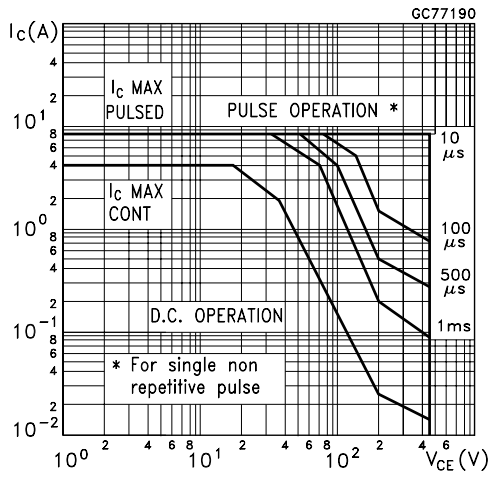

Derating Curve

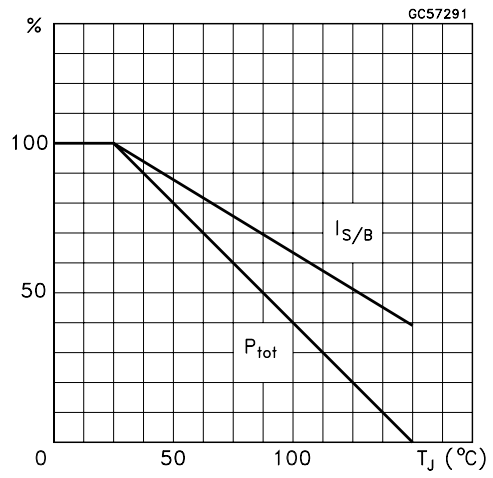

DC Current Gain

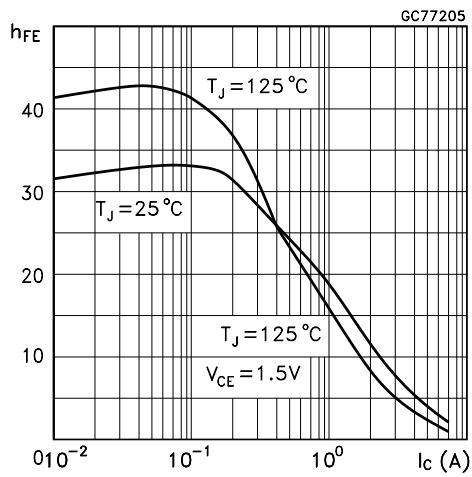

DC Current Gain

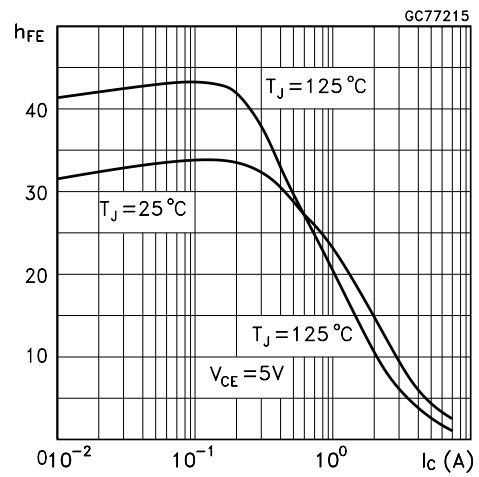

Collector Emitter Saturation Voltage

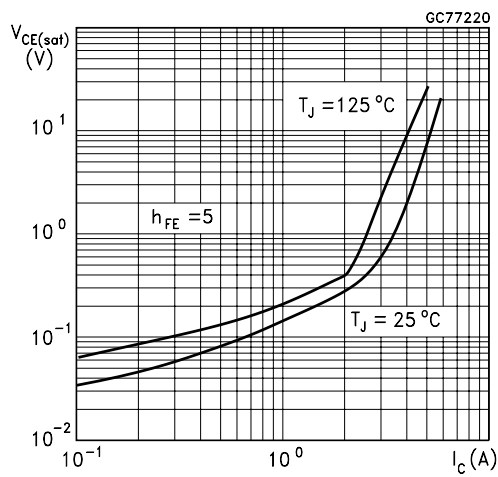

Base Emitter Saturation Voltage

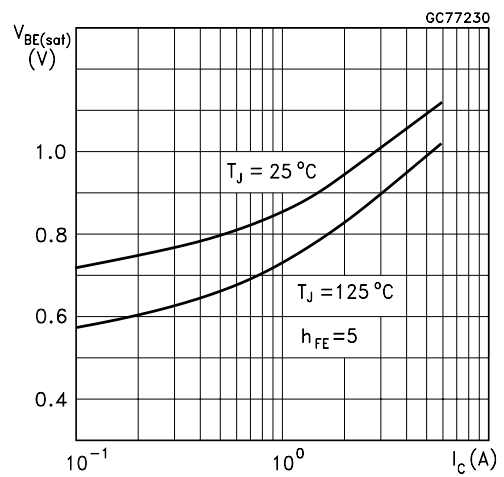

# BULB39D

## Inductive Fall Time

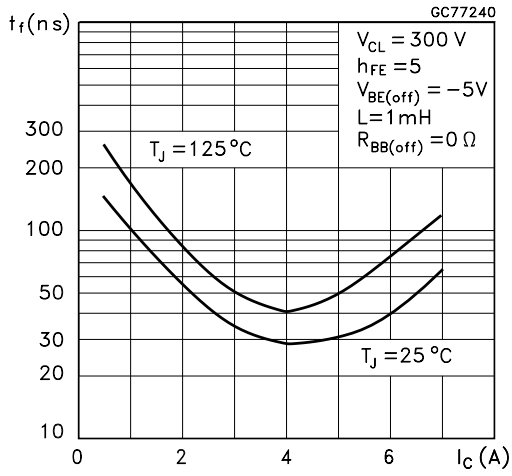

## Inductive Storage Time

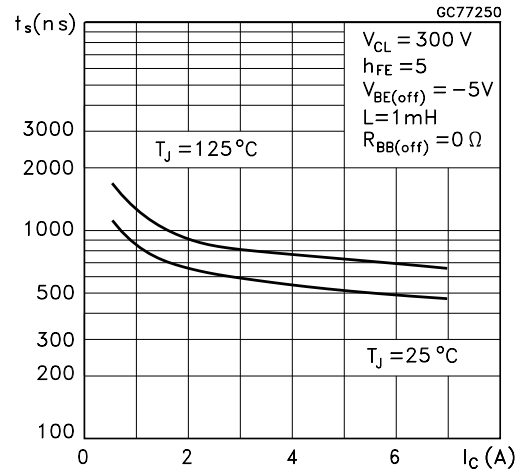

## Reverse Biased SOA

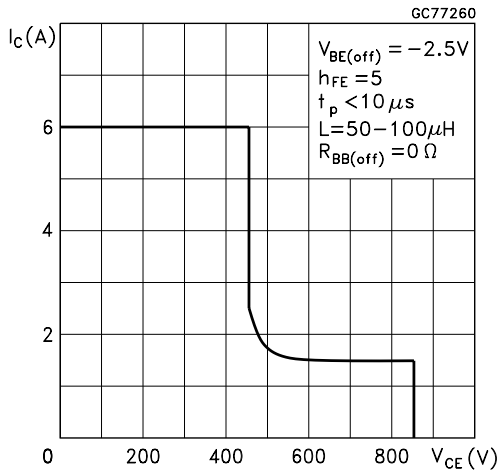

**TO-263 (D<sup>2</sup>PAK) MECHANICAL DATA**

DIM.	mm			inch		
	MIN.	TYP.	MAX.	MIN.	TYP.	MAX.
A	4.40		4.60	0.173		0.181
A1	2.49		2.69	0.098		0.106
A2	0.03		0.23	0.001		0.009
B	0.70		0.93	0.027		0.036
B2	1.14		1.70	0.044		0.067
C	0.45		0.60	0.017		0.023
C2	1.23		1.36	0.048		0.053
D	8.95		9.35	0.352		0.368
D1		8.00			0.315	
E	10.00		10.40	0.393		0.409
E1		8.50			0.334	
G	4.88		5.28	0.192		0.208
L	15.00		15.85	0.590		0.624
L2	1.27		1.4	0.050		0.055
L3	1.40		1.75	0.055		0.068
M	2.40		3.2	0.094		0.126
R		0.40			0.016	
V2	0°		8°	0°		8°

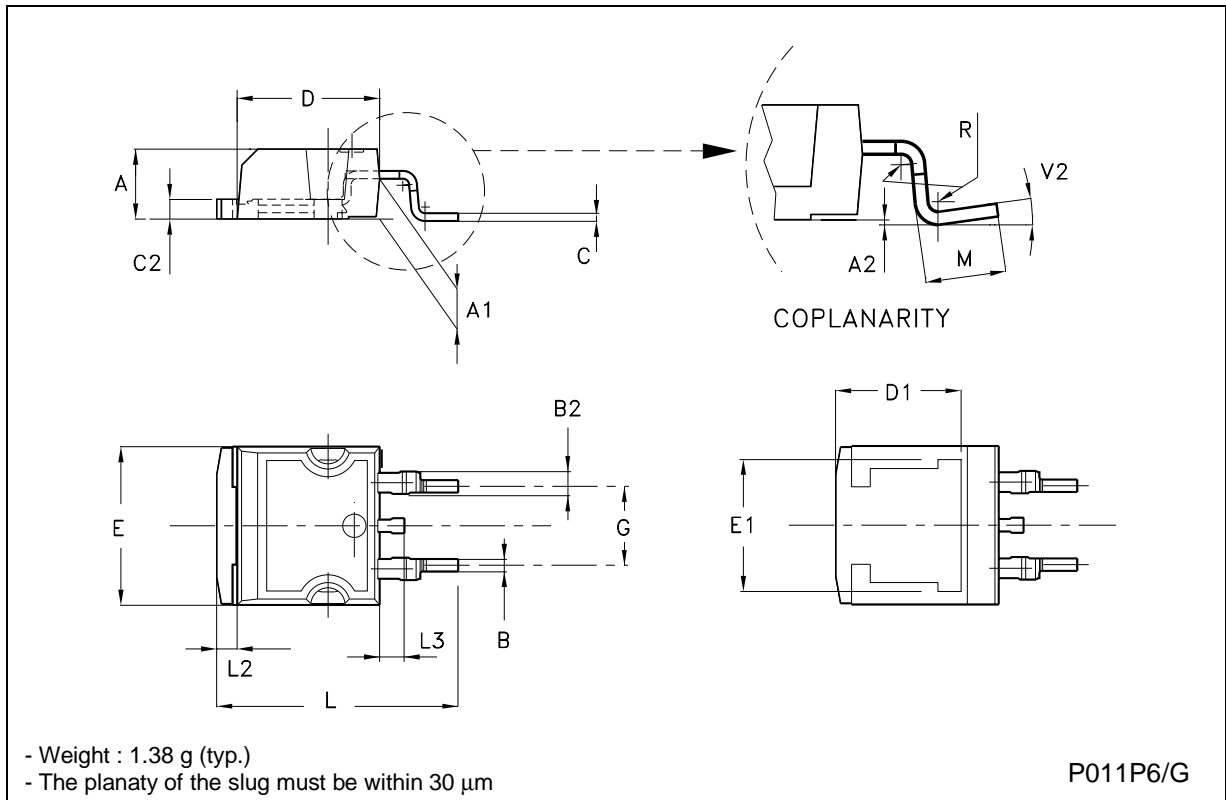

Information furnished is believed to be accurate and reliable. However, STMicroelectronics assumes no responsibility for the consequences of use of such information nor for any infringement of patents or other rights of third parties which may result from its use. No license is granted by implication or otherwise under any patent or patent rights of STMicroelectronics. Specification mentioned in this publication are subject to change without notice. This publication supersedes and replaces all information previously supplied. STMicroelectronics products are not authorized for use as critical components in life support devices or systems without express written approval of STMicroelectronics.

The ST logo is a trademark of STMicroelectronics

© 2001 STMicroelectronics – Printed in Italy – All Rights Reserved



STMicroelectronics GROUP OF COMPANIES

Australia - Brazil - China - Finland - France - Germany - Hong Kong - India - Italy - Japan - Malaysia - Malta - Morocco - Singapore - Spain - Sweden - Switzerland - United Kingdom - U.S.A.

<http://www.st.com>

## Looking for pricing, stock, or lifecycle information?

Click below to explore more details on WIN SOURCE:

-  [View BULB39D-1 on WIN SOURCE](#)
-  [STMicroelectronics](#) Information

## Optimize Your Supply Chain with WIN SOURCE Solutions

-  Global Sourcing Solution
-  Obsolete Management
-  Cost Control Management
-  Shortage Management
-  Alternative Solution
-  Excess Inventory Management