



**THE DATASHEET OF
NCP702SN31T1G**



NCP702

200 mA, Ultra-Low Quiescent Current, Ultra-Low Noise, LDO Linear Voltage Regulator

Noise sensitive applications such as Phase Locked Loops, Oscillators, Frequency Synthesizers, Low Noise Amplifiers and other Precision Instrumentation require very clean power supplies. The NCP702 is a 200 mA LDO that provides the engineer with a very stable, accurate voltage with ultra-low noise and very high Power Supply Rejection Ratio (PSRR), making it suitable for RF applications. The device doesn't require an additional noise bypass capacitor to achieve ultra-low noise performance. In order to optimize performance for battery operated portable applications, the NCP702 employs an Adaptive Ground Current feature for ultra-low ground current consumption during light-load conditions.

Features

- Operating Input Voltage Range: 2.0 V to 5.5 V
- Available in Fixed Voltage Options: 0.8 to 3.5 V
Contact Factory for Other Voltage Options
- Output Voltage Trimming Step: 2.5 mV
- Ultra-Low Quiescent Current of Typ. 10 μ A
- Ultra-Low Noise: 11 μ V_{RMS} from 100 Hz to 100 kHz
- Very Low Dropout: 140 mV Typical at 200 mA
- $\pm 2\%$ Accuracy Over Full Load/Line/Temperature
- High PSRR: 68 dB at 1 kHz
- Thermal Shutdown and Current Limit Protections
- Internal Soft-Start to Limit the Turn-On Inrush Current
- Stable with a 1 μ F Ceramic Output Capacitor
- Available in TSOP-5 and XDFN 1.5 x 1.5 mm Package
- Active Output Discharge for Fast Output Turn-Off
- These are Pb-Free Devices

Typical Applications

- PDAs, Mobile Phones, GPS, Smartphones
- Wireless Handsets, Wireless LAN, Bluetooth, Zigbee
- Portable Medical Equipment
- Other Battery Powered Applications

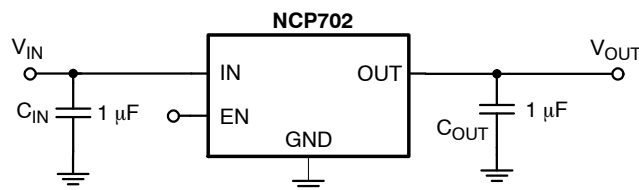
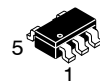

Figure 1. Typical Application Schematic



ON Semiconductor®

<http://onsemi.com>



TSOP-5
SN SUFFIX
CASE 483



XDFN-6
MX SUFFIX
CASE 711AE

MARKING DIAGRAMS

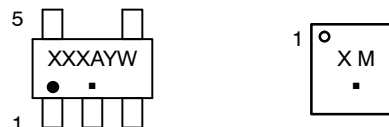

X, XXX = Specific Device Code
M = Date Code
A = Assembly Location
Y = Year
W = Work Week
▪ = Pb-Free Package

PIN CONNECTIONS

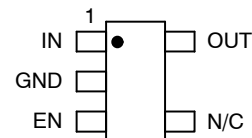

5-Pin TSOP-5
(Top View)

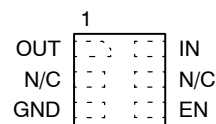

6-Pin XDFN 1.5 x 1.5 mm
(Top View)

ORDERING INFORMATION

See detailed ordering, marking and shipping information in the package dimensions section on page 18 of this data sheet.

NCP702

Table 3. THERMAL CHARACTERISTICS (Note 3)

| Rating | Symbol | Value | Unit |
|---|---------------|-------|-----------------------------|
| Thermal Characteristics, TSOP-5, Thermal Resistance, Junction-to-Air Thermal Characterization Parameter, Junction-to-Lead (Pin 2) | θ_{JA} | 224 | $^{\circ}\text{C}/\text{W}$ |
| | ψ_{JA} | 115 | |
| Thermal Characteristics, XDFN6 1.5 x 1.5 mm Thermal Resistance, Junction-to-Air Thermal Characterization Parameter, Junction-to-Board | θ_{JA} | 149 | $^{\circ}\text{C}/\text{W}$ |
| | ψ_{JB} | 81 | |

3. Single component mounted on 1 oz, FR4 PCB with 645 mm² Cu area.

Table 4. ELECTRICAL CHARACTERISTICS

$-40^{\circ}\text{C} \leq T_J \leq 125^{\circ}\text{C}$; $V_{IN} = V_{OUT(NOM)} + 0.3 \text{ V}$ or 2.0 V , whichever is greater; $V_{EN} = 0.9 \text{ V}$, $I_{OUT} = 10 \text{ mA}$, $C_{IN} = C_{OUT} = 1 \mu\text{F}$.
Typical values are at $T_J = +25^{\circ}\text{C}$. Min/Max values are specified for $T_J = -40^{\circ}\text{C}$ and $T_J = 125^{\circ}\text{C}$ respectively. (Note 4)

| Parameter | Test Conditions | Symbol | Min | Typ | Max | Unit |
|---|---|----------------------|------|---------|-----|----------------------------|
| Operating Input Voltage | | V_{IN} | 2.0 | | 5.5 | V |
| Undervoltage lock-out | V_{IN} rising | UVLO | 1.2 | 1.6 | 1.9 | V |
| Output Voltage Accuracy | $V_{OUT} + 0.3 \text{ V} \leq V_{IN} \leq 5.5 \text{ V}$, $I_{OUT} = 0 - 200 \text{ mA}$ | V_{OUT} | -2 | | +2 | % |
| Line Regulation | $V_{OUT} + 0.3 \text{ V} \leq V_{IN} \leq 4.5 \text{ V}$, $I_{OUT} = 10 \text{ mA}$ | Reg _{LINE} | | 290 | | $\mu\text{V}/\text{V}$ |
| | $V_{OUT} + 0.3 \text{ V} \leq V_{IN} \leq 5.5 \text{ V}$, $I_{OUT} = 10 \text{ mA}$ | Reg _{LINE} | | 440 | | $\mu\text{V}/\text{V}$ |
| Load Regulation | $I_{OUT} = 0 \text{ mA}$ to 200 mA | Reg _{LOAD} | | 13 | | $\mu\text{V}/\text{mA}$ |
| Dropout voltage (Note 5) | $I_{OUT} = 200 \text{ mA}$, $V_{OUT(nom)} = 2.5 \text{ V}$ | V_{DO} | | 140 | 200 | mV |
| Output Current Limit | $V_{OUT} = 90\% V_{OUT(nom)}$ | I_{CL} | 220 | 385 | 550 | mA |
| Quiescent current | $I_{OUT} = 0 \text{ mA}$ | I_Q | | 10 | 16 | μA |
| Ground current | $I_{OUT} = 2 \text{ mA}$ | I_{GND} | | 60 | | μA |
| | $I_{OUT} = 200 \text{ mA}$ | I_{GND} | | 160 | | μA |
| Shutdown current (Note 6) | $V_{EN} \leq 0.4 \text{ V}$ | I_{DIS} | | 0.005 | | μA |
| | $V_{EN} \leq 0.4 \text{ V}$, $V_{IN} = 4.5 \text{ V}$ | I_{DIS} | | 0.01 | 1 | μA |
| EN Pin Threshold Voltage | V_{EN} Voltage increasing | V_{EN_HI} | 0.9 | | | V |
| | V_{EN} Voltage decreasing | V_{EN_LO} | | | 0.4 | |
| EN Pin Input Current | $V_{EN} = V_{IN} = 5.5 \text{ V}$ | I_{EN} | | 110 | 500 | nA |
| Turn-On Time (Note 7) | $C_{OUT} = 1.0 \mu\text{F}$, $I_{OUT} = 1 \text{ mA}$ | t_{ON} | | 300 | | μs |
| Output Voltage Overshoot on Start-up (Note 8) | $V_{EN} = 0 \text{ V}$ to 0.9 V , $0 \leq I_{OUT} \leq 200 \text{ mA}$ | ΔV_{OUT} | | | 2 | % |
| Load Transient | $I_{OUT} = 1 \text{ mA}$ to 200 mA or $I_{OUT} = 200 \text{ mA}$ to 1 mA in $10 \mu\text{s}$, $C_{OUT} = 1 \mu\text{F}$ | ΔV_{OUT} | | -30/+30 | | mV |
| Power Supply Rejection Ratio | $V_{IN} = 3 \text{ V}$, $V_{OUT} = 2.5 \text{ V}$ $I_{OUT} = 150 \text{ mA}$ | $f = 100 \text{ Hz}$ | PSRR | 70 | | dB |
| | | $f = 1 \text{ kHz}$ | | 68 | | |
| | | $f = 10 \text{ kHz}$ | | 53 | | |
| Output Noise Voltage | $V_{OUT} = 2.5 \text{ V}$, $V_{IN} = 3 \text{ V}$, $I_{OUT} = 200 \text{ mA}$ $f = 100 \text{ Hz}$ to 100 kHz | V_N | | 11 | | μV_{rms} |
| Active Discharge Resistance | $V_{EN} < 0.4 \text{ V}$ | R_{DIS} | | 1 | | k Ω |
| Thermal Shutdown Temperature | Temperature increasing from $T_J = +25^{\circ}\text{C}$ | T_{SD} | | 160 | | $^{\circ}\text{C}$ |
| Thermal Shutdown Hysteresis | Temperature falling from T_{SD} | T_{SDH} | - | 20 | - | $^{\circ}\text{C}$ |

4. Performance guaranteed over the indicated operating temperature range by design and/or characterization. Production tested at $T_J = T_A = 25^{\circ}\text{C}$. Low duty cycle pulse techniques are used during testing to maintain the junction temperature as close to ambient as possible.
5. Characterized when V_{OUT} falls 100 mV below the regulated voltage at $V_{IN} = V_{OUT(NOM)} + 0.3 \text{ V}$.
6. Shutdown Current is the current flowing into the IN pin when the device is in the disable state.
7. Turn-On time is measured from the assertion of EN pin to the point when the output voltage reaches $0.98 V_{OUT(NOM)}$
8. Guaranteed by design.

TYPICAL CHARACTERISTICS

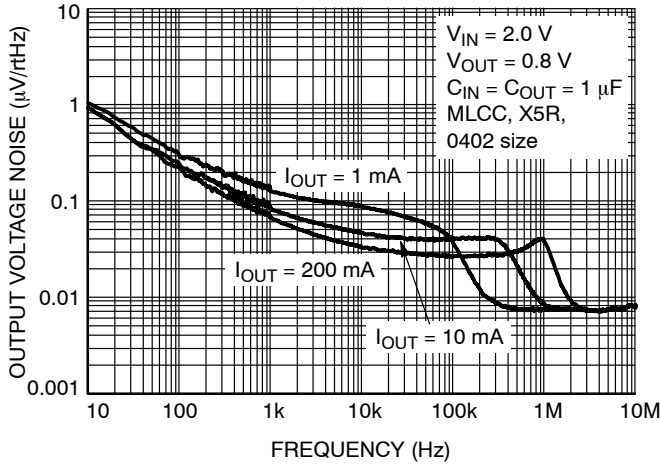

| I _{OUT} | RMS Output Noise | |
|------------------|------------------|------------------|
| | 10 Hz – 100 kHz | 100 Hz – 100 kHz |
| 1 mA | 21.74 | 21.17 |
| 10 mA | 14.62 | 14.07 |
| 200 mA | 10.74 | 10.02 |

Figure 3. Output Voltage Noise Spectral Density for V_{OUT} = 0.8 V, C_{OUT} = 1 μF

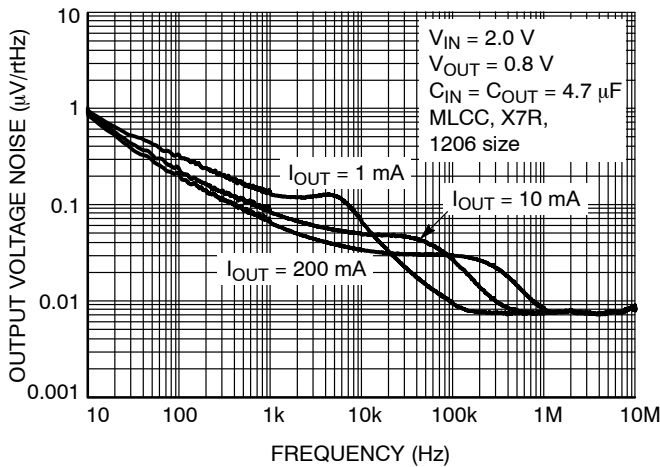

| I _{OUT} | RMS Output Noise | |
|------------------|------------------|------------------|
| | 10 Hz – 100 kHz | 100 Hz – 100 kHz |
| 1 mA | 14.16 | 13.43 |
| 10 mA | 14.20 | 13.70 |
| 200 mA | 10.99 | 10.48 |

Figure 4. Output Voltage Noise Spectral Density for V_{OUT} = 0.8 V, C_{OUT} = 4.7 μF

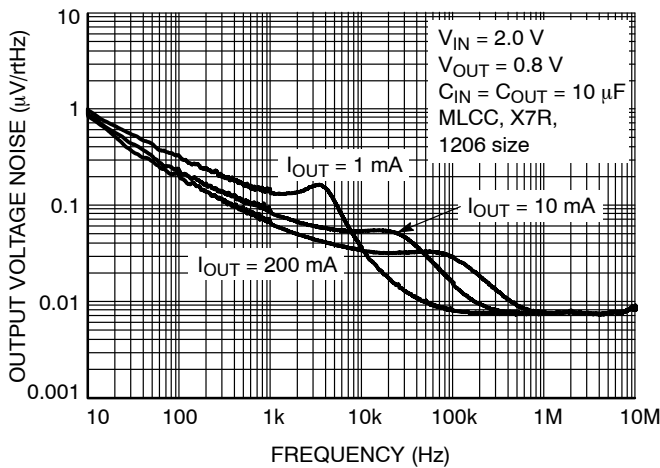

| I _{OUT} | RMS Output Noise | |
|------------------|------------------|------------------|
| | 10 Hz – 100 kHz | 100 Hz – 100 kHz |
| 1 mA | 12.94 | 12.11 |
| 10 mA | 12.78 | 12.25 |
| 200 mA | 11.33 | 10.83 |

Figure 5. Output Voltage Noise Spectral Density for V_{OUT} = 0.8 V, C_{OUT} = 10 μF

TYPICAL CHARACTERISTICS

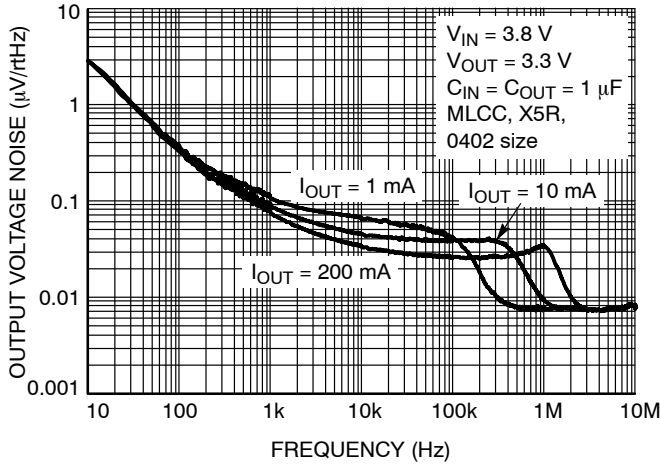

| I _{OUT} | RMS Output Noise | |
|------------------|------------------|------------------|
| | 10 Hz – 100 kHz | 100 Hz – 100 kHz |
| 1 mA | 20.28 | 17.87 |
| 10 mA | 16.73 | 13.90 |
| 200 mA | 13.70 | 10.21 |

Figure 6. Output Voltage Noise Spectral Density for V_{OUT} = 3.3 V, C_{OUT} = 1 μF

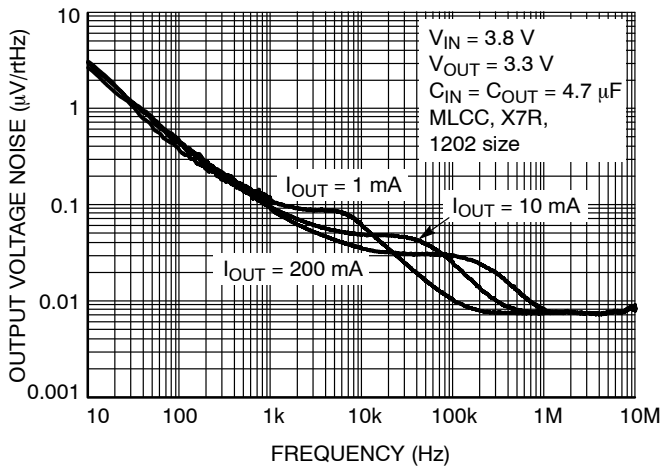

| I _{OUT} | RMS Output Noise | |
|------------------|------------------|------------------|
| | 10 Hz – 100 kHz | 100 Hz – 100 kHz |
| 1 mA | 15.76 | 11.82 |
| 10 mA | 17.09 | 13.88 |
| 200 mA | 14.51 | 11.47 |

Figure 7. Output Voltage Noise Spectral Density for V_{OUT} = 3.3 V, C_{OUT} = 4.7 μF

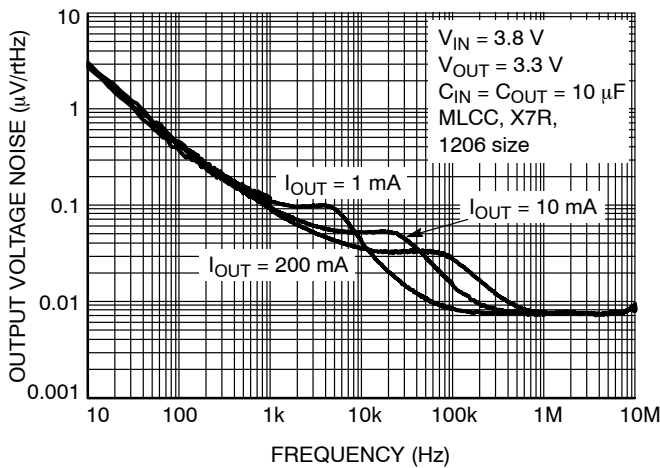

| I _{OUT} | RMS Output Noise | |
|------------------|------------------|------------------|
| | 10 Hz – 100 kHz | 100 Hz – 100 kHz |
| 1 mA | 14.87 | 10.57 |
| 10 mA | 16.00 | 12.65 |
| 200 mA | 14.89 | 11.84 |

Figure 8. Output Voltage Noise Spectral Density for V_{OUT} = 3.3 V, C_{OUT} = 10 μF

TYPICAL CHARACTERISTICS

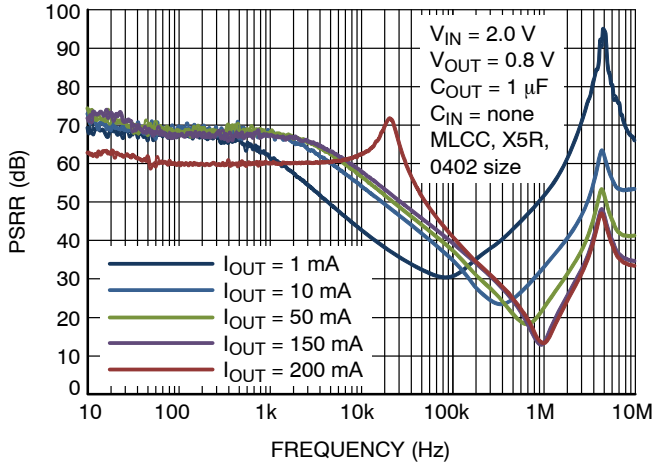

Figure 9. Power Supply Rejection Ratio, $V_{OUT} = 0.8\text{ V}$, $C_{OUT} = 1\ \mu\text{F}$

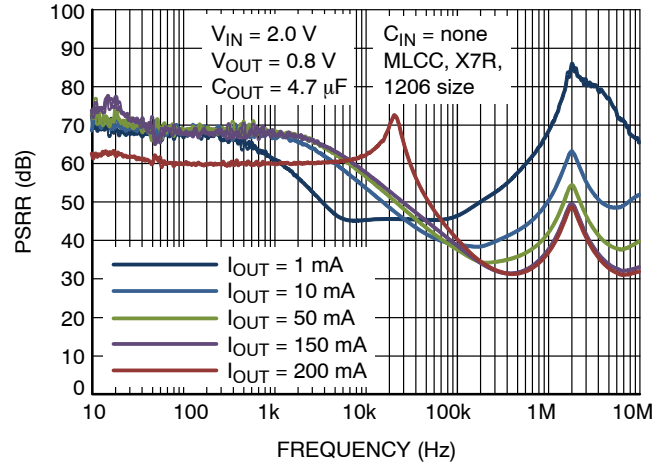

Figure 10. Power Supply Rejection Ratio, $V_{OUT} = 0.8\text{ V}$, $C_{OUT} = 4.7\ \mu\text{F}$

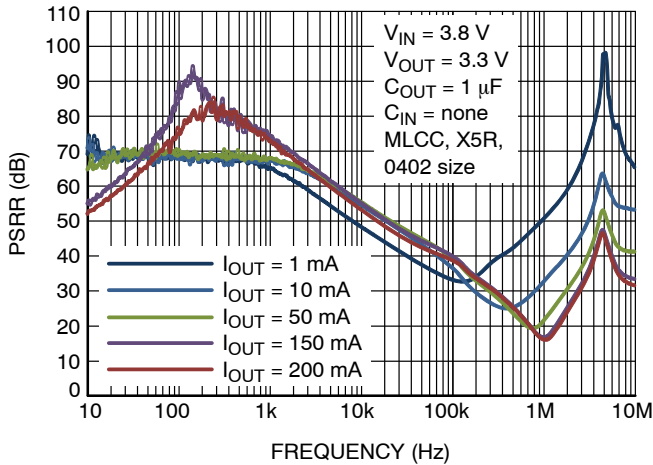

Figure 11. Power Supply Rejection Ratio, $V_{OUT} = 3.3\text{ V}$, $C_{OUT} = 1\ \mu\text{F}$

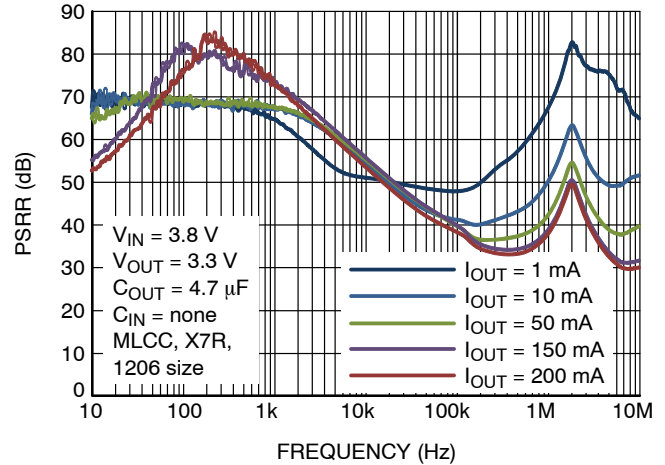

Figure 12. Power Supply Rejection Ratio, $V_{OUT} = 3.3\text{ V}$, $C_{OUT} = 4.7\ \mu\text{F}$

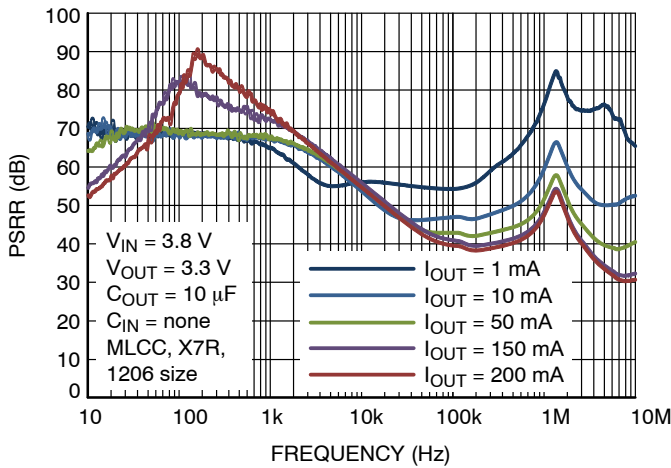

Figure 13. Power Supply Rejection Ratio, $V_{OUT} = 3.3\text{ V}$, $C_{OUT} = 10\ \mu\text{F}$

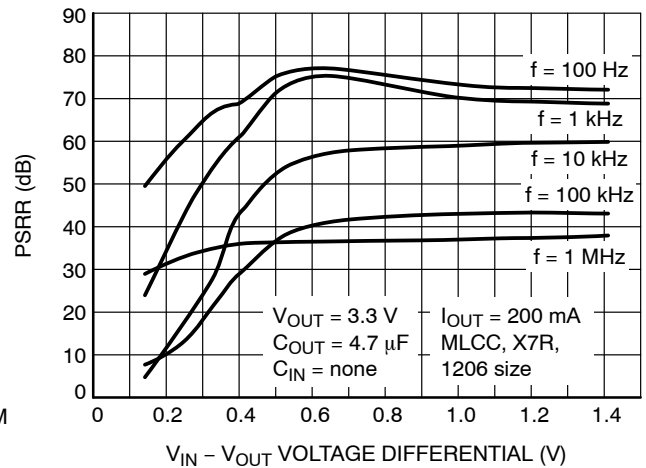

Figure 14. PSRR vs. Voltage Differential, $C_{OUT} = 4.7\ \mu\text{F}$, $I_{OUT} = 200\text{ mA}$

TYPICAL CHARACTERISTICS

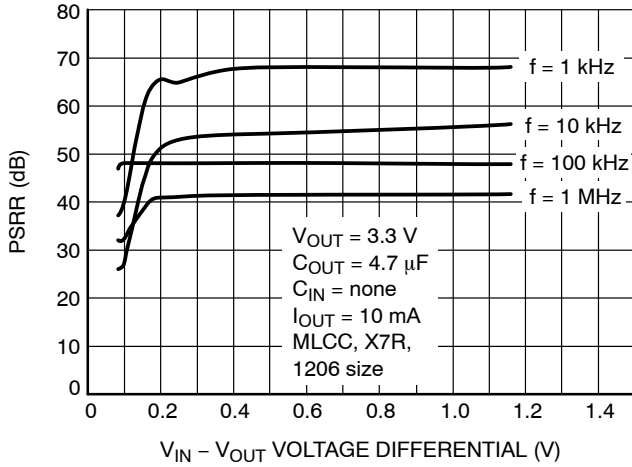

Figure 15. PSRR vs. Voltage Differential, $C_{OUT} = 4.7 \mu F$, $I_{OUT} = 10 \text{ mA}$



Figure 16. Quiescent Current vs. Input Voltage, $V_{OUT} = 3.3 \text{ V}$

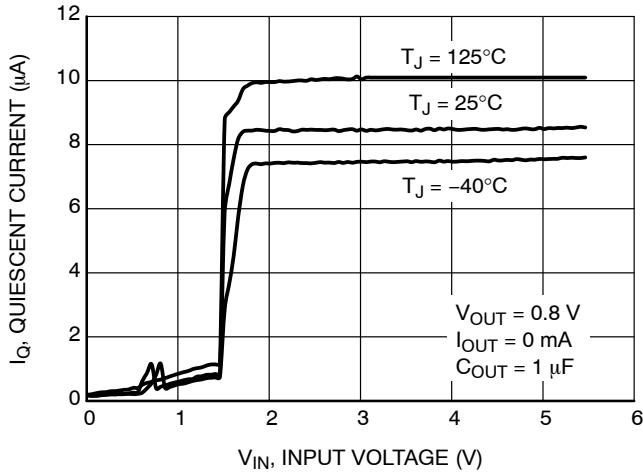

Figure 17. Quiescent Current vs. Input Voltage, $V_{OUT} = 0.8 \text{ V}$

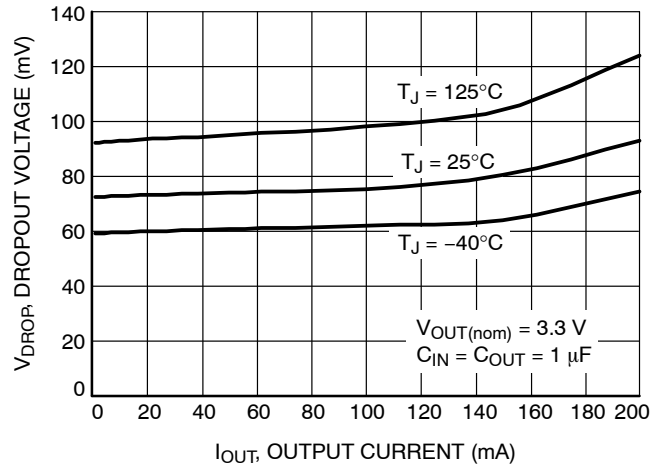

Figure 18. Dropout Voltage vs. Output Current, $V_{OUT} = 3.3 \text{ V}$

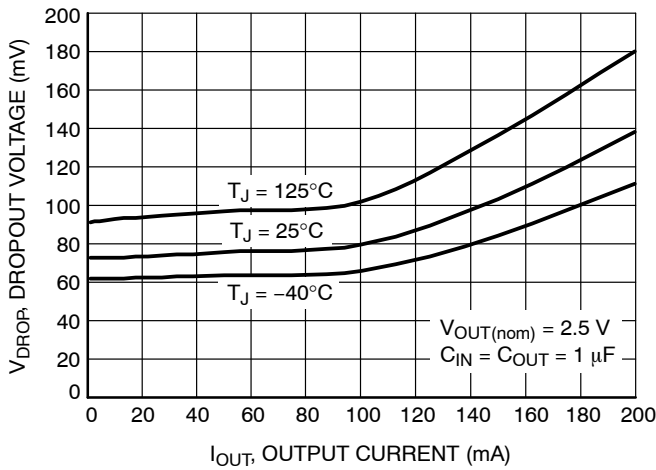

Figure 19. Dropout Voltage vs. Output Current, $V_{OUT} = 2.5 \text{ V}$

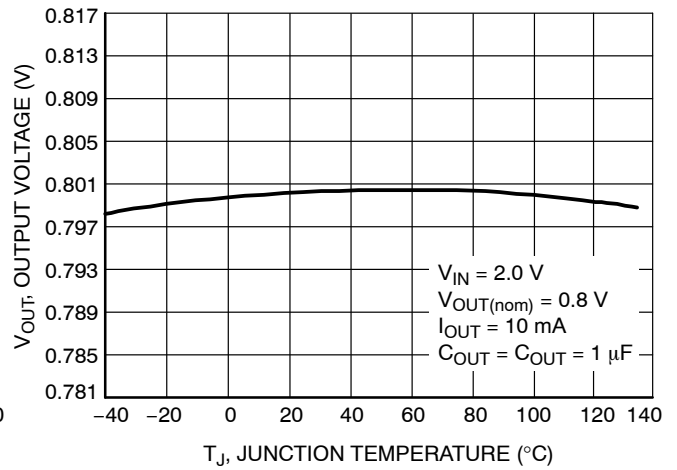

Figure 20. Output Voltage vs. Temperature, $V_{OUT} = 0.8 \text{ V}$

TYPICAL CHARACTERISTICS

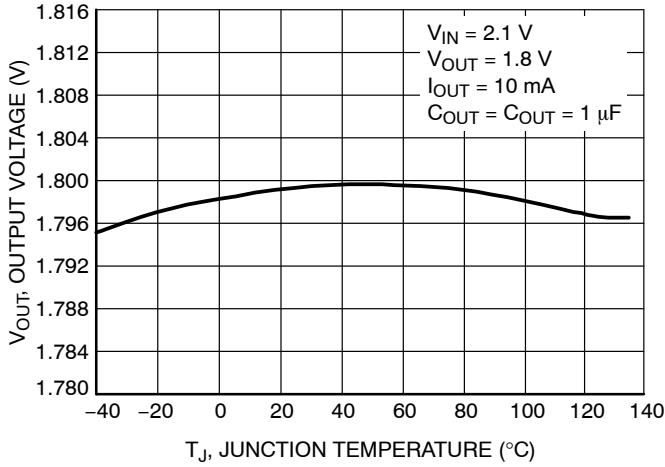

Figure 21. Output Voltage vs. Temperature, $V_{OUT} = 1.8\text{ V}$

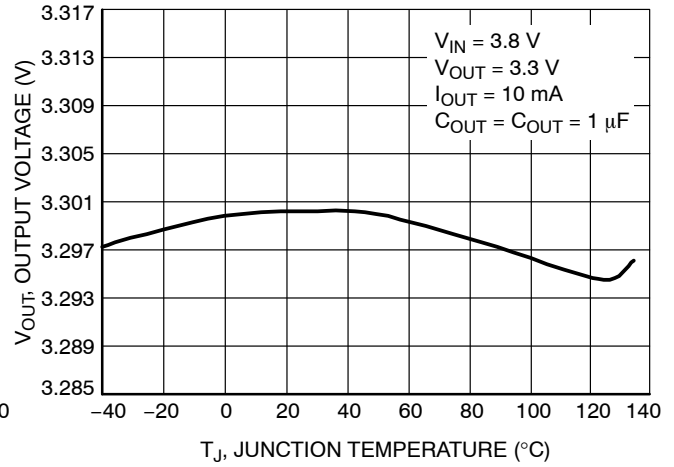

Figure 22. Output Voltage vs. Temperature, $V_{OUT} = 3.3\text{ V}$

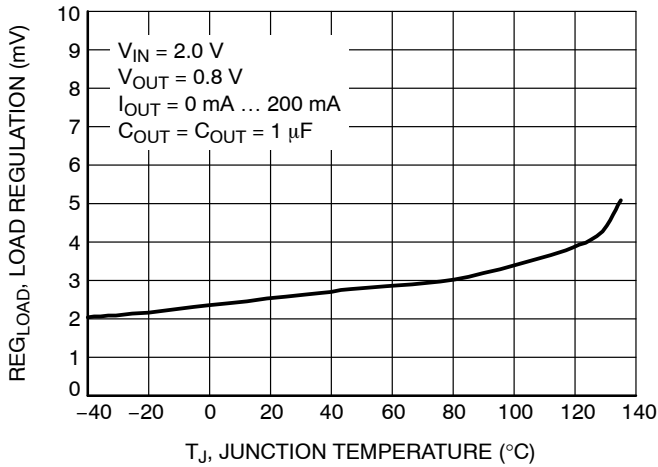

Figure 23. Load Regulation vs. Temperature, $V_{OUT} = 0.8\text{ V}$

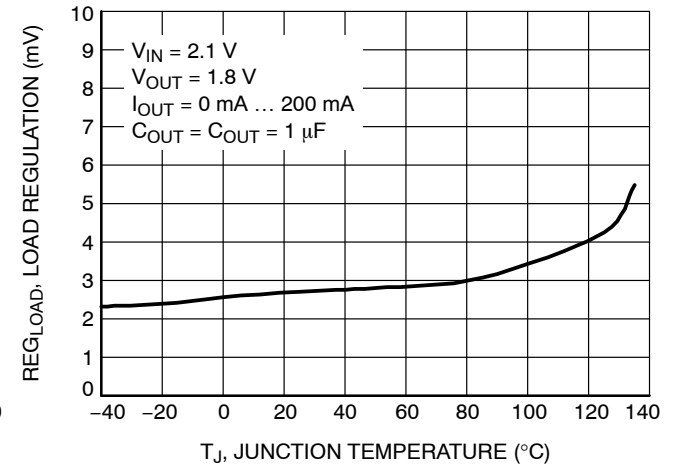

Figure 24. Load Regulation vs. Temperature, $V_{OUT} = 1.8\text{ V}$

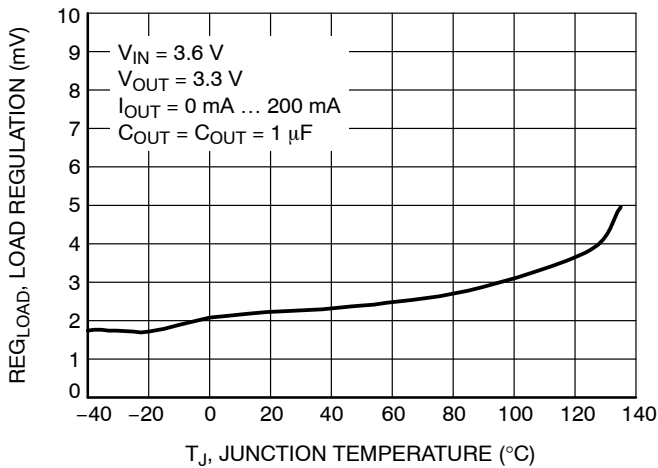

Figure 25. Load Regulation vs. Temperature, $V_{OUT} = 3.3\text{ V}$

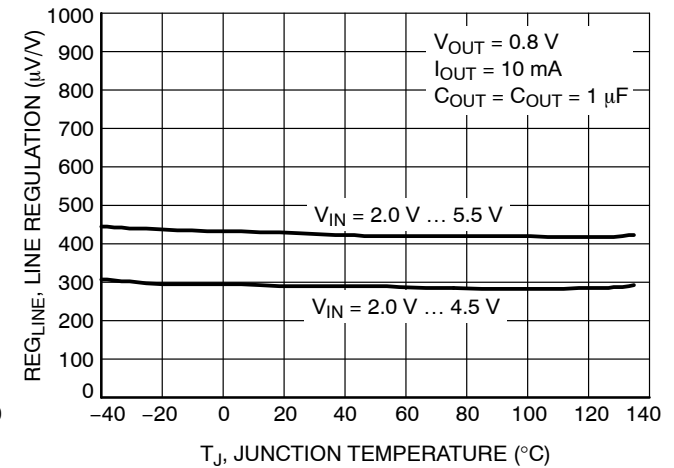

Figure 26. Line Regulation vs. Temperature, $V_{OUT} = 0.8\text{ V}$

TYPICAL CHARACTERISTICS

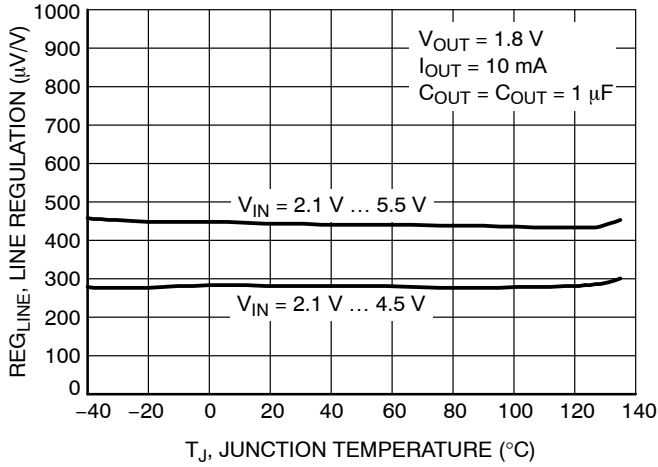

Figure 27. Line Regulation vs. Temperature, $V_{OUT} = 1.8\text{ V}$

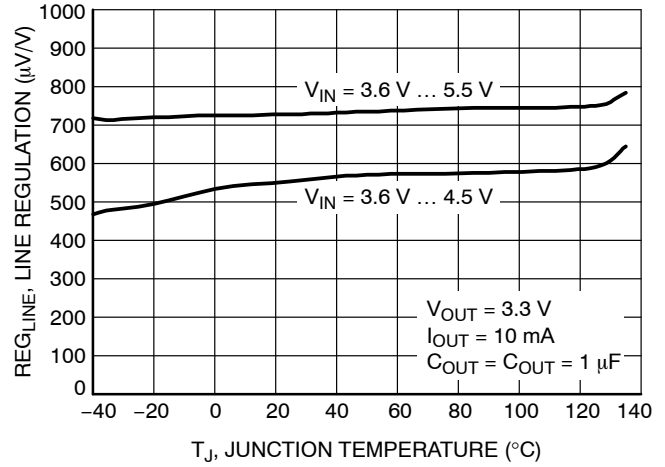

Figure 28. Line Regulation vs. Temperature, $V_{OUT} = 3.3\text{ V}$

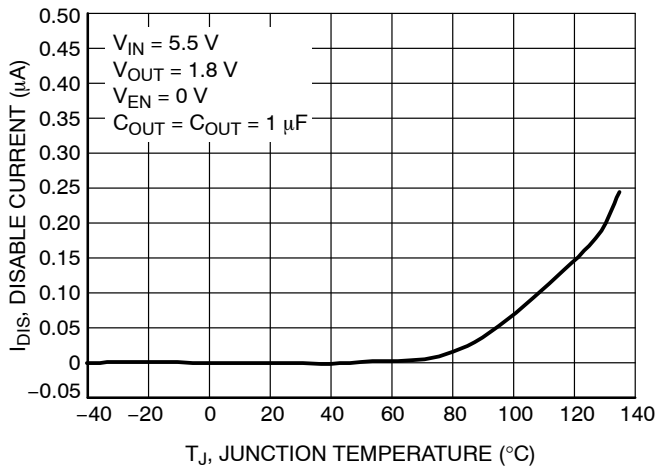

Figure 29. Disable Current vs. Temperature, $V_{OUT} = 1.8\text{ V}$

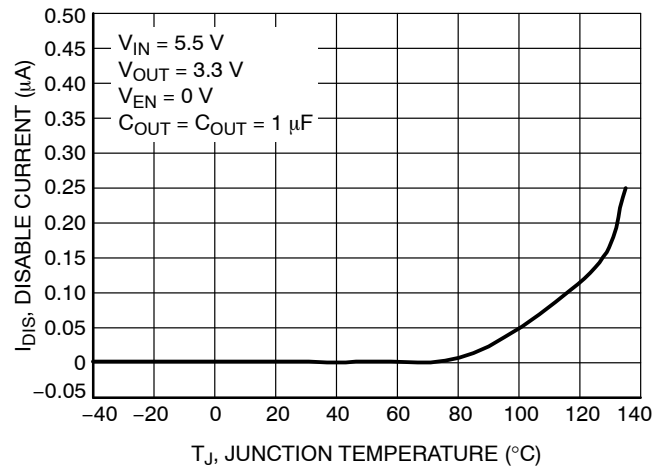

Figure 30. Disable Current vs. Temperature, $V_{OUT} = 3.3\text{ V}$

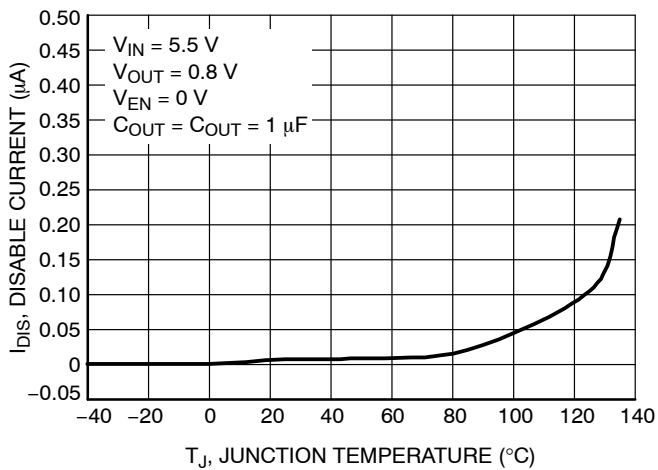

Figure 31. Disable Current vs. Temperature, $V_{OUT} = 0.8\text{ V}$

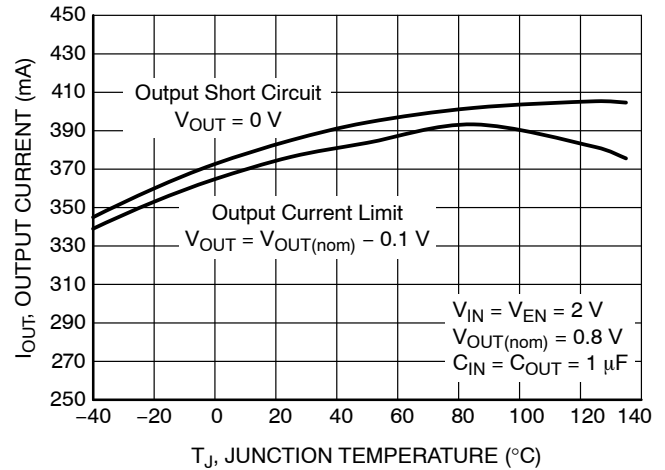

Figure 32. Output Current Limit vs. Temperature, $V_{OUT} = 0.8\text{ V}$

TYPICAL CHARACTERISTICS

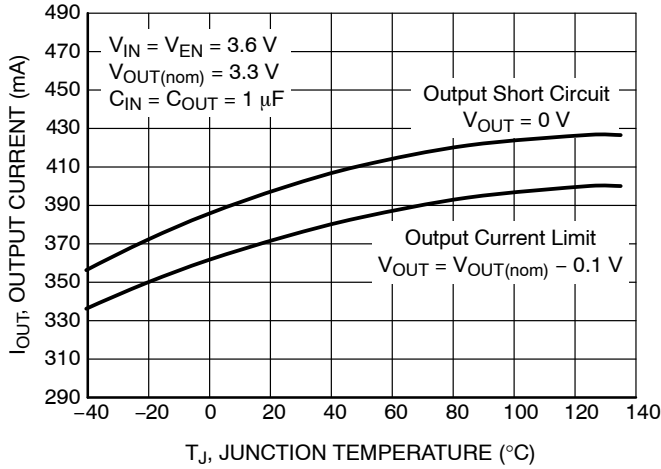

Figure 33. Output Current Limit vs. Temperature, $V_{OUT} = 3.3V$

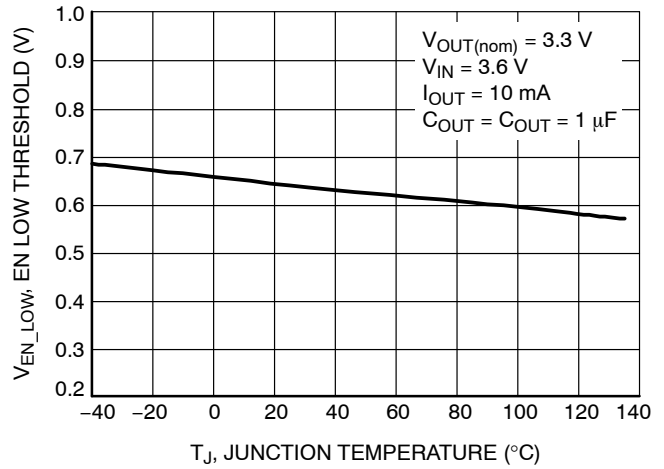

Figure 34. Enable Low Threshold Voltage

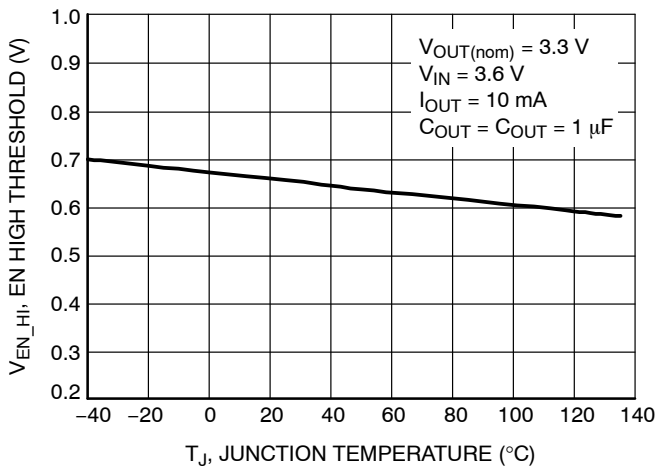

Figure 35. Enable High Threshold Voltage

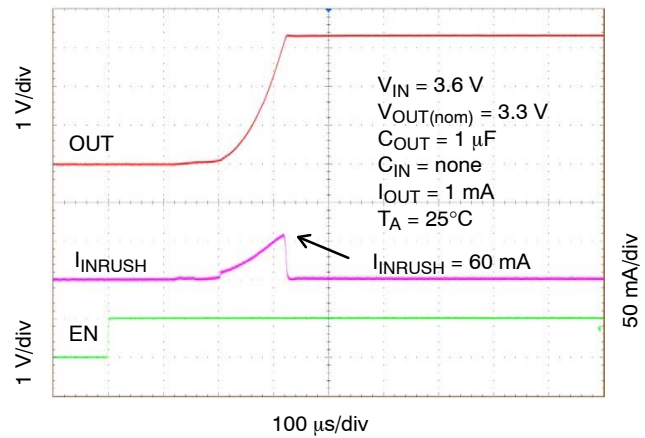

Figure 36. Enable Turn-On Response, $V_{OUT} = 3.3V$, $C_{OUT} = 1\mu F$

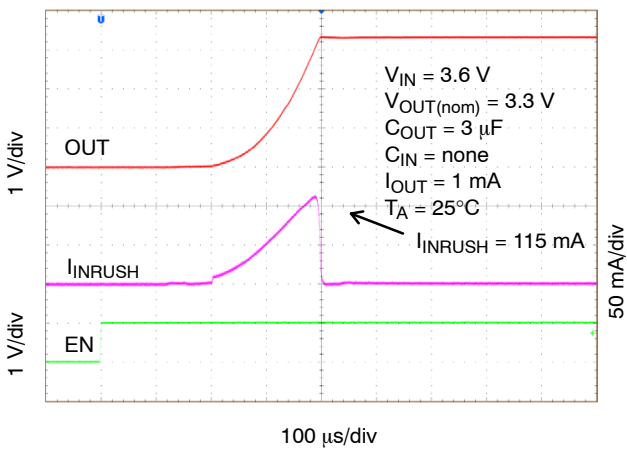

Figure 37. Enable Turn-On Response, $V_{OUT} = 3.3V$, $C_{OUT} = 3\mu F$

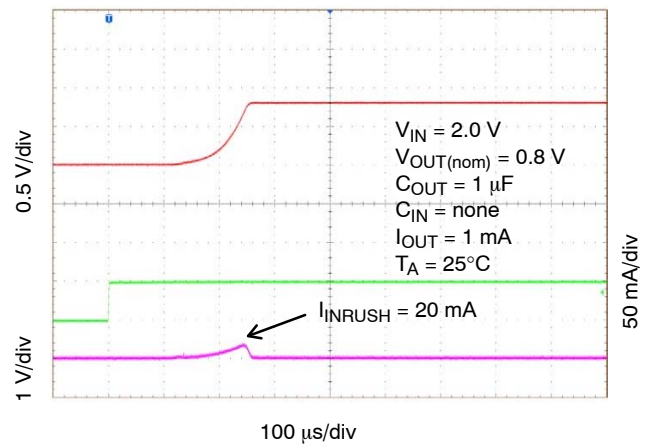

Figure 38. Enable Turn-On Response, $V_{OUT} = 0.8V$, $C_{OUT} = 1\mu F$

TYPICAL CHARACTERISTICS

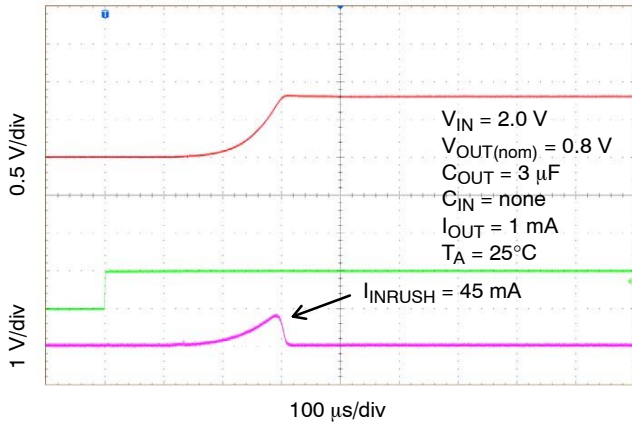

Figure 39. Enable Turn-On Response, $V_{OUT} = 0.8\text{ V}$, $C_{OUT} = 3\ \mu\text{F}$

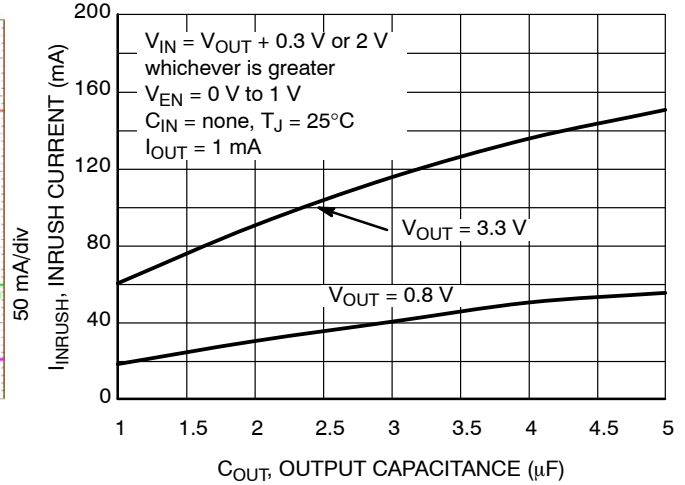

Figure 40. Turn-On Inrush Current vs. Output Capacitance

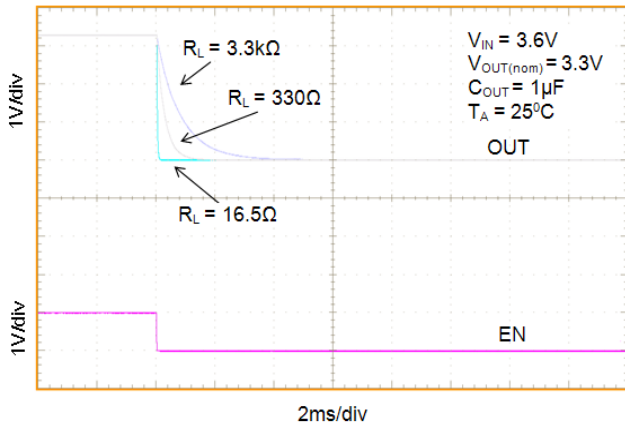

Figure 41. Enable Turn-Off Response, $V_{OUT} = 3.3\text{ V}$, $C_{OUT} = 1\ \mu\text{F}$

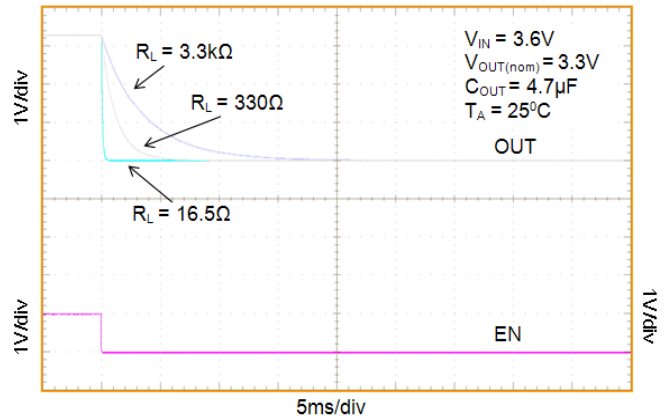

Figure 42. Enable Turn-Off Response, $V_{OUT} = 3.3\text{ V}$, $C_{OUT} = 4.7\ \mu\text{F}$

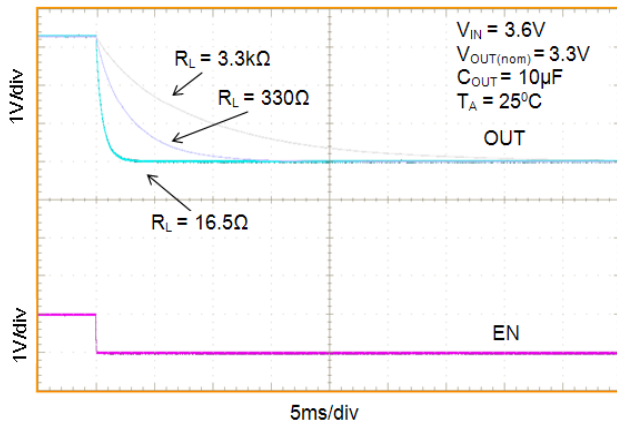

Figure 43. Enable Turn-Off Response, $V_{OUT} = 3.3\text{ V}$, $C_{OUT} = 10\ \mu\text{F}$

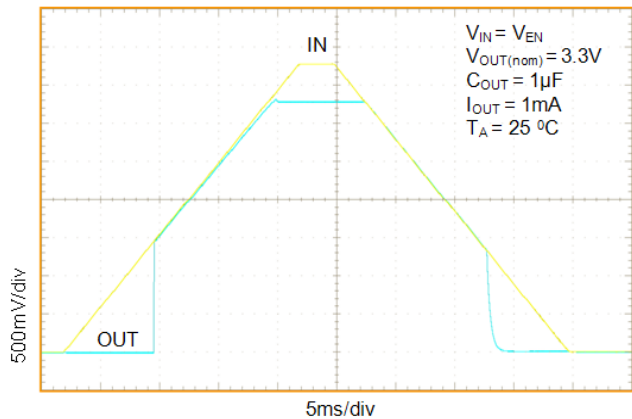

Figure 44. Slow Input Voltage Turn-On/Turn-Off, $V_{OUT} = 3.3\text{ V}$

TYPICAL CHARACTERISTICS

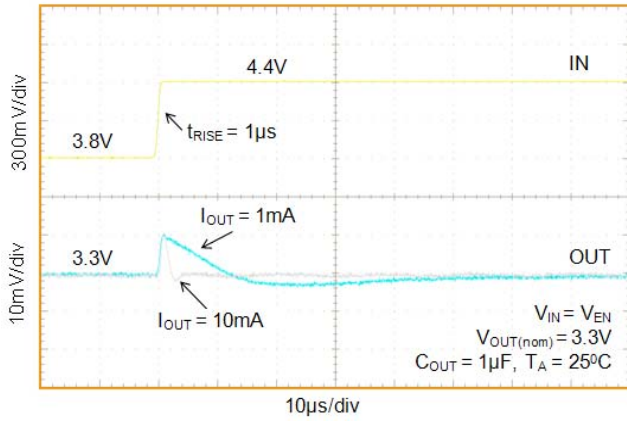

Figure 45. Line Transient Response – Rising Edge, $V_{OUT} = 3.3\text{ V}$

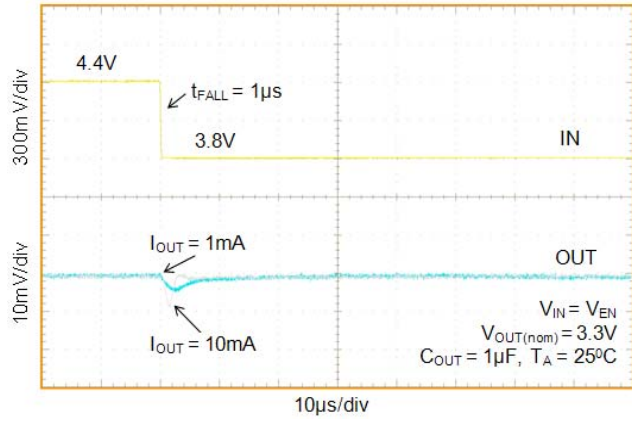

Figure 46. Line Transient Response – Falling Edge, $V_{OUT} = 3.3\text{ V}$

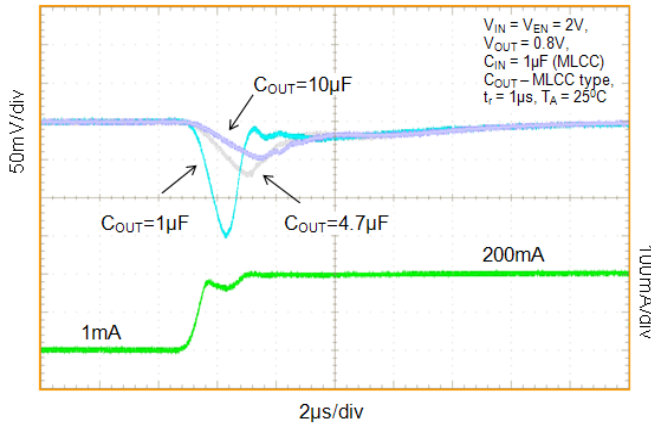

Figure 47. Load Transient Response – Rising Edge, $I_{OUT} = 1\text{ mA} - 200\text{ mA}$, $V_{OUT} = 0.8\text{ V}$

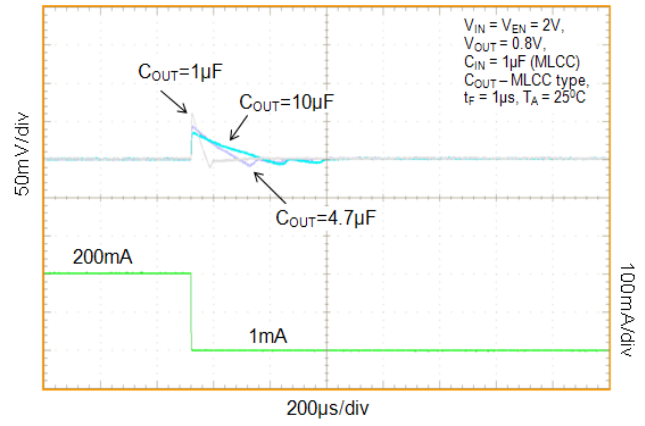

Figure 48. Load Transient Response – Falling Edge, $I_{OUT} = 1\text{ mA} - 200\text{ mA}$, $V_{OUT} = 0.8\text{ V}$

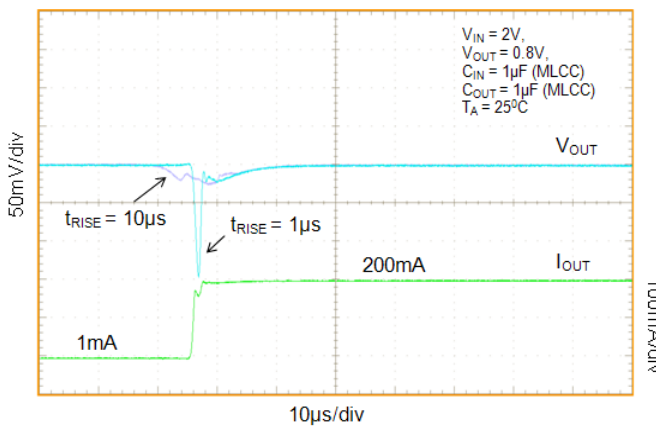

Figure 49. Load Transient Response – Rising Edge, $I_{OUT} = 1\text{ mA} - 200\text{ mA}$, $C_{OUT} = 1.0\text{ }\mu\text{F}$

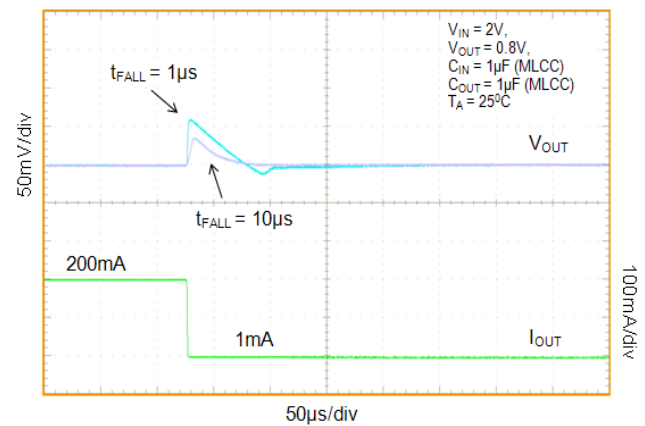

Figure 50. Load Transient Response – Falling Edge, $I_{OUT} = 1\text{ mA} - 200\text{ mA}$, $C_{OUT} = 1.0\text{ }\mu\text{F}$

TYPICAL CHARACTERISTICS

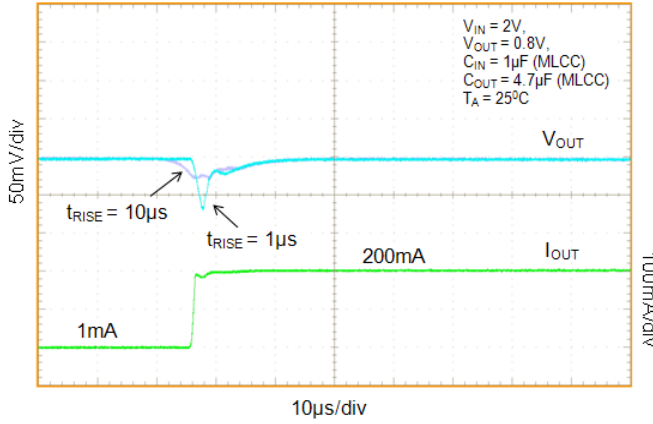

Figure 51. Load Transient Response – Rising Edge, $I_{OUT} = 1\text{ mA} - 200\text{ mA}$, $C_{OUT} = 4.7\text{ }\mu\text{F}$

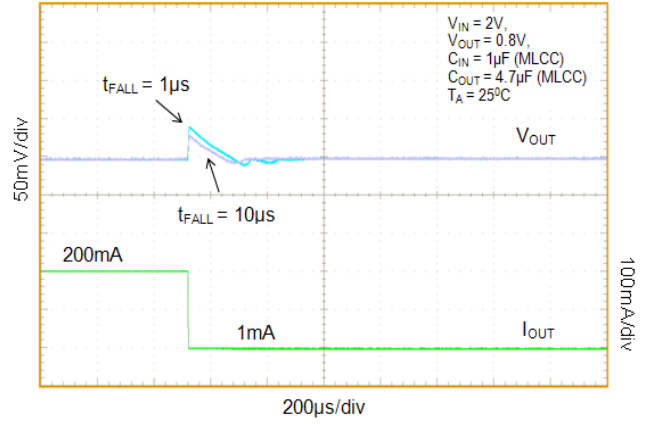

Figure 52. Load Transient Response – Falling Edge, $I_{OUT} = 1\text{ mA} - 200\text{ mA}$, $C_{OUT} = 4.7\text{ }\mu\text{F}$

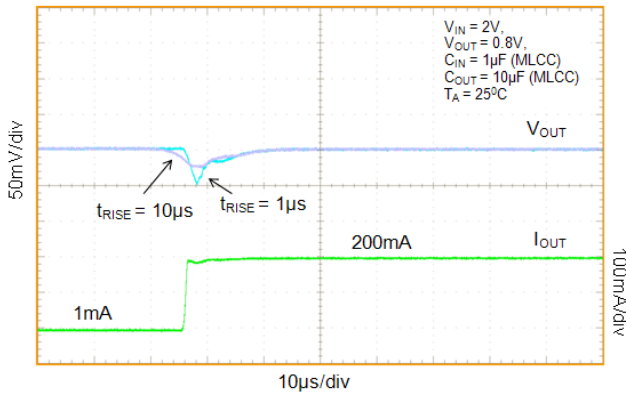

Figure 53. Load Transient Response – Rising Edge, $I_{OUT} = 1\text{ mA} - 200\text{ mA}$, $C_{OUT} = 10\text{ }\mu\text{F}$

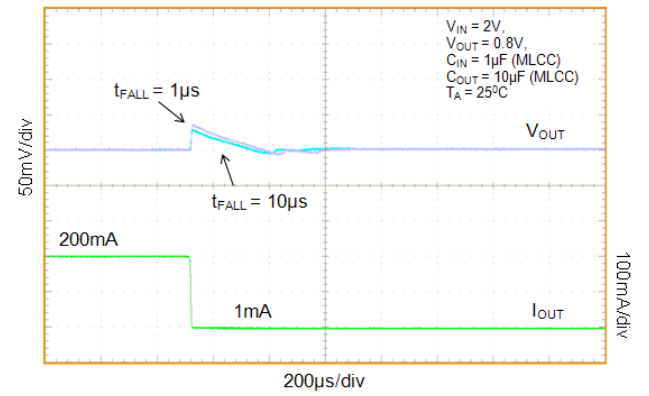

Figure 54. Load Transient Response – Falling Edge, $I_{OUT} = 1\text{ mA} - 200\text{ mA}$, $C_{OUT} = 10\text{ }\mu\text{F}$

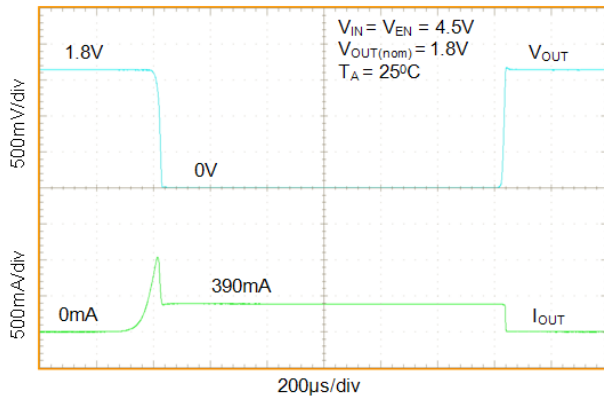

Figure 55. Output Short Circuit Response

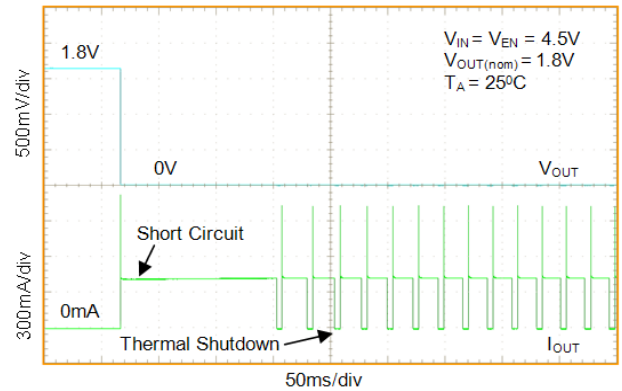

Figure 56. Cycling between Output Short Circuit and Thermal Shutdown

TYPICAL CHARACTERISTICS

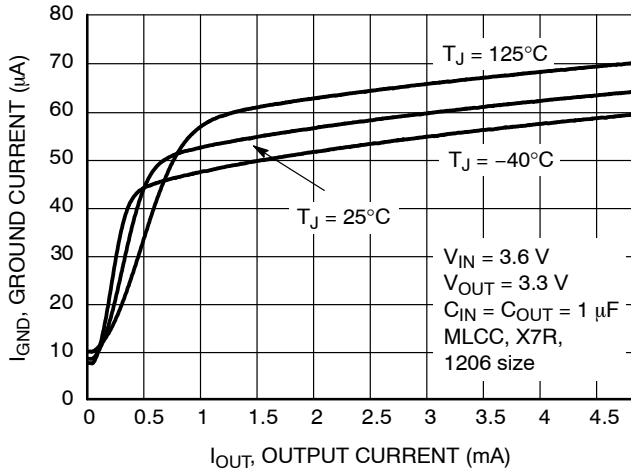

Figure 57. Ground Current vs. Output Current, $I_{OUT} = 0 \text{ mA to } 5 \text{ mA}$

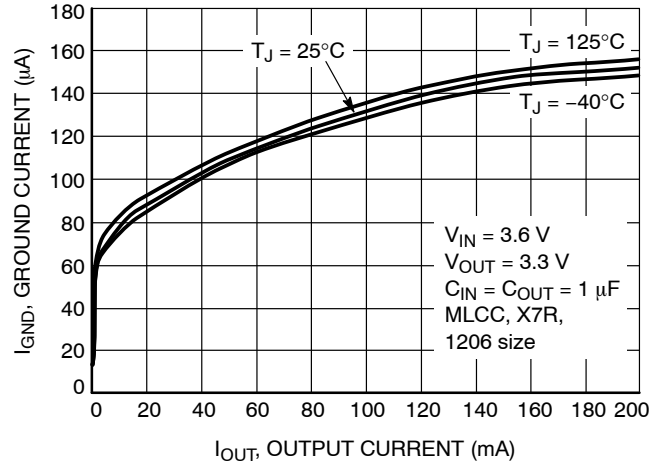

Figure 58. Ground Current vs. Output Current, $I_{OUT} = 0 \text{ mA to } 200 \text{ mA}$

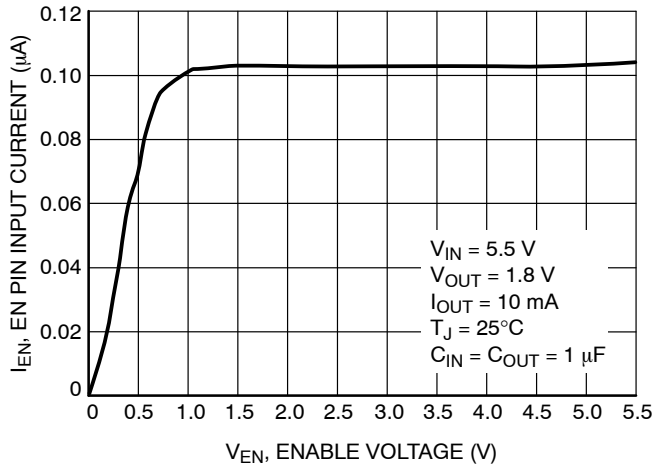

Figure 59. EN Pin Input Current vs. Enable Pin Voltage

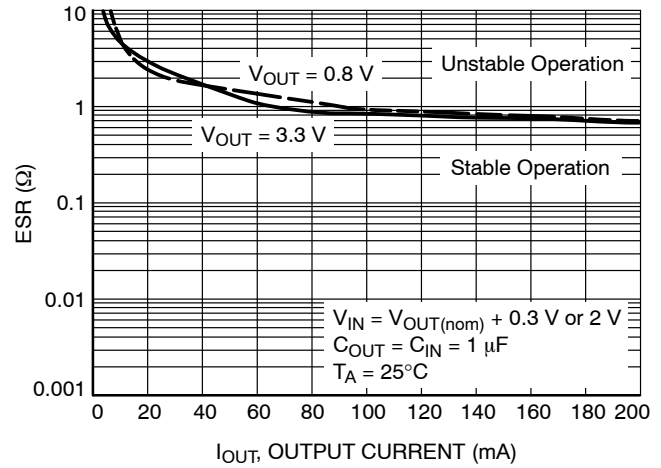

Figure 60. Output Capacitor ESR vs. Output Current

NCP702

APPLICATIONS INFORMATION

General

The NCP702 is a high performance 200 mA Low Dropout Linear Regulator. This device delivers excellent noise and dynamic performance.

Thanks to its adaptive ground current feature the device consumes only 10 μ A of quiescent current at no-load condition.

The regulator features ultra-low noise of 11 μ V_{RMS}, PSRR of 68 dB at 1 kHz and very good load/line transient performance. Such excellent dynamic parameters and small package size make the device an ideal choice for powering the precision analog and noise sensitive circuitry in portable applications. The LDO achieves this ultra low noise level output without the need for a noise bypass capacitor.

A logic EN input provides ON/OFF control of the output voltage. When the EN is low the device consumes as low as typ. 10 nA from the IN pin.

The LDO achieves ultra-low output voltage noise without the need for additional noise bypass capacitor.

The device is fully protected in case of output overload, output short circuit condition and overheating, assuring a very robust design.

Input Capacitor Selection (C_{IN})

It is recommended to connect a minimum of 1 μ F Ceramic X5R or X7R capacitor close to the IN pin of the device. This capacitor will provide a low impedance path for unwanted AC signals or noise modulated onto constant input voltage.

There is no requirement for the min./max. ESR of the input capacitor but it is recommended to use ceramic capacitors for their low ESR and ESL. A good input

capacitor will limit the influence of input trace inductance and source resistance during sudden load current changes.

Larger input capacitor may be necessary if fast and large load transients are encountered in the application.

Output Decoupling (C_{OUT})

The NCP702 is designed to be stable with a small 1.0 μ F ceramic capacitor on the output. To assure proper operation it is strongly recommended to use min. 1.0 μ F capacitor with the initial tolerance of $\pm 10\%$, made of X7R or X5R dielectric material types.

There is no requirement for the minimum value of Equivalent Series Resistance (ESR) for the C_{OUT} but the maximum value of ESR should be less than 700 m Ω .

Larger output capacitors could be used to improve the load transient response or high frequency PSRR as shown in typical characteristics. The initial tolerance requirements can be wider than $\pm 10\%$ when using capacitors larger than 1 μ F.

It is not recommended to use tantalum capacitors on the output due to their large ESR. The equivalent series resistance of tantalum capacitors is also strongly dependent on the temperature, increasing at low temperature. The tantalum capacitors are generally more costly than ceramic capacitors.

The table on this page lists the capacitors which were used during the IC evaluation.

No-load Operation

The regulator remains stable and regulates the output voltage properly within the $\pm 2\%$ tolerance limits even with no external load applied to the output.

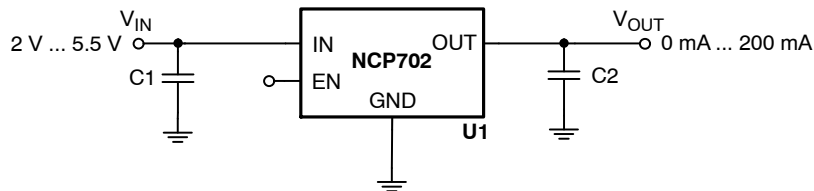

Figure 61. Typical Applications Schematics

LIST OF CAPACITORS USED DURING THE NCP702 EVALUATION:

| Symbol | Manufacturer | Part Number | Description |
|--------|---------------|--------------------|---|
| C1, C2 | Kemet | C0402C105K8PACTU | 1 μ F Ceramic $\pm 10\%$, 10 V, 0402, X5R |
| | TDK | C1005X5R1A105K | - - |
| | Murata | GRM155R61A105KE15D | - - |
| | AVX | 0402ZD105KAT2A | - - |
| | Multicomp | MCCA000571 | 1 μ F Ceramic $\pm 10\%$, 50 V, 1206, X7R |
| | Panason - ECG | ECJ-0EB0J475M | 4.7 μ F Ceramic $\pm 20\%$, 6.3 V, 0402, X5R |

APPLICATIONS INFORMATION

Enable Operation

The NCP702 uses the EN pin to enable/disable its output and to deactivate/activate the active discharge function.

If the EN pin voltage is <0.4 V the device is guaranteed to be disabled. The pass transistor is turned-off so that there is virtually no current flow between the IN and OUT. The active discharge transistor is active so that the output voltage V_{OUT} is pulled to GND through a 1 k Ω resistor. In the disable state the device consumes as low as typ. 10 nA from the V_{IN} .

If the EN pin voltage >0.9 V the device is guaranteed to be enabled. The NCP702 regulates the output voltage and the active discharge transistor is turned-off.

The EN pin has internal pull-down current source with typ. value of 110 nA which assures that the device is turned-off when the EN pin is not connected. A build in 2 mV of hysteresis in the EN prevents from periodic on/off oscillations that can occur due to noise.

In the case where the EN function isn't required the EN pin should be tied directly to IN.

Undervoltage Lockout

The internal UVLO circuitry assures that the device becomes disabled when the V_{IN} falls below typ. 1.5 V. When the V_{IN} voltage ramps-up the NCP702 becomes enabled, if V_{IN} rises above typ. 1.6 V. The 100 mV hysteresis prevents on/off oscillations that can occur due to noise on V_{IN} line.

Reverse Current

The PMOS pass transistor has an inherent body diode which will be forward biased in the case that $V_{OUT} > V_{IN}$. Due to this fact in cases where the extended reverse current condition is anticipated the device may require additional external protection.

Output Current Limit

Output Current is internally limited within the IC to a typical 380 mA. The NCP702 will source this amount of current measured with the output voltage 100 mV lower than

the nominal V_{OUT} . If the Output Voltage is directly shorted to ground ($V_{OUT} = 0$ V), the short circuit protection will limit the output current to 390 mA (typ). The current limit and short circuit protection will work properly up to $V_{IN} = 5.5$ V at $T_A = 25^\circ\text{C}$. There is no limitation for the short circuit duration.

Thermal Shutdown

When the die temperature exceeds the Thermal Shutdown threshold ($T_{SD} - 160^\circ\text{C}$ typical), Thermal Shutdown event is detected and the device is disabled. The IC will remain in this state until the die temperature decreases below the Thermal Shutdown Reset threshold ($T_{SDU} - 140^\circ\text{C}$ typical). Once the IC temperature falls below the 140°C the LDO is enabled again. The thermal shutdown feature provides protection from a catastrophic device failure due to accidental overheating. This protection is not intended to be used as a substitute for proper heat sinking.

Power Dissipation

As power dissipated in the NCP702 increases, it might become necessary to provide some thermal relief. The maximum power dissipation supported by the device is dependent upon board design and layout. Mounting pad configuration on the PCB, the board material, and the ambient temperature affect the rate of junction temperature rise for the part. For reliable operation junction temperature should be limited to $+125^\circ\text{C}$.

The maximum power dissipation the NCP702 can handle is given by:

$$P_{D(MAX)} = \frac{[125 - T_A]}{\theta_{JA}} \quad (\text{eq. 1})$$

The power dissipated by the NCP702 for given application conditions can be calculated from the following equations:

$$P_D \approx V_{IN}(I_{GND@I_{OUT}}) + I_{OUT}(V_{IN} - V_{OUT}) \quad (\text{eq. 2})$$

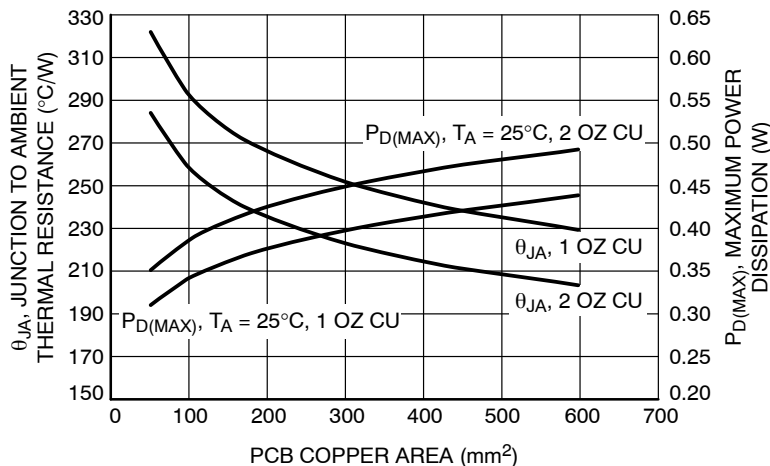

Figure 62. θ_{JA} and $P_{D(MAX)}$ vs. Copper Area (TSOP5)

NCP702

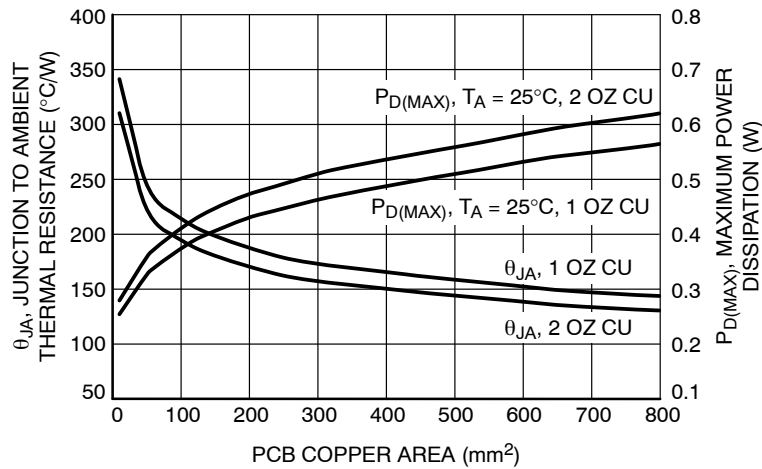

Figure 63. θ_{JA} and $P_{D(MAX)}$ vs. Copper Area (XDFN6)

Load Regulation

The NCP702 features very good load regulation of maximum 2.6 mV in the 0 mA to 200 mA range. In order to achieve this very good load regulation a special attention to PCB design is necessary. The trace resistance from the OUT pin to the point of load can easily approach 100 m Ω which will cause a 20 mV voltage drop at full load current, deteriorating the excellent load regulation.

Line Regulation

The IC features very good line regulation of 0.44 mV/V measured from $V_{IN} = V_{OUT} + 0.3$ V to 5.5 V. For battery operated applications it may be important that the line regulation from $V_{IN} = V_{OUT} + 0.3$ V up to 4.5 V is only 0.29 mV/V.

Power Supply Rejection Ratio

The NCP702 features very good Power Supply Rejection ratio. If desired the PSRR at higher frequencies in the range 100 kHz – 10 MHz can be tuned by the selection of C_{OUT} capacitor and proper PCB layout.

Output Noise

The IC is designed for ultra-low noise output voltage. Figures 3 – 8 illustrate the noise performance for different V_{OUT} , I_{OUT} , C_{OUT} . Generally the noise performance in the indicated frequency range improves with increasing output current, although even at $I_{OUT} = 1$ mA the noise levels are below 22 μV_{RMS} .

Turn-On Time

The turn-on time is defined as the time period from EN assertion to the point in which V_{OUT} will reach 98% of its nominal value. This time is dependent on $V_{OUT(NOM)}$, C_{OUT} , T_A . The turn-on time temperature dependence is shown below:

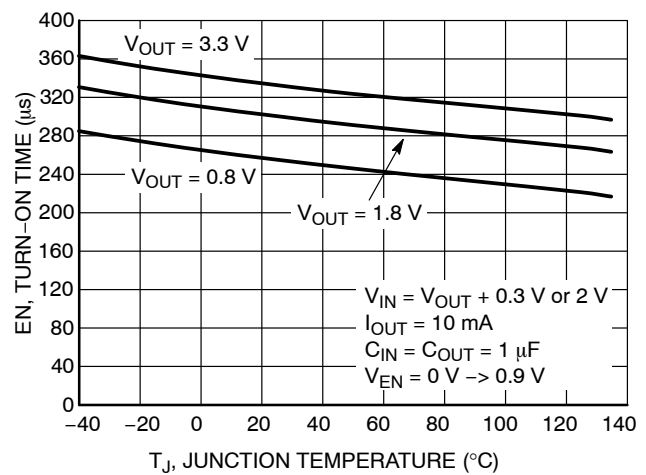

Figure 64. Turn-On Time vs. Temperature

Internal Soft-Start

The Internal Soft-Start circuitry will limit the inrush current during the LDO turn-on phase. Please refer to Figure 43 for typical inrush current values for given output capacitance.

The soft-start function prevents from any output voltage overshoots and assures monotonic ramp-up of the output voltage.

PCB Layout Recommendations

To obtain good transient performance and good regulation characteristics place C_{IN} and C_{OUT} capacitors close to the device pins and make the PCB traces wide. In order to minimize the solution size use 0402 capacitors. Larger copper area connected to the pins will also improve the device thermal resistance. The actual power dissipation can be calculated by the formula given in Equation 2.

NCP702

ORDERING INFORMATION

| Device | Voltage Option | Marking | Package | Shipping † |
|---------------|----------------|---------|--------------------|--------------------|
| NCP702MX18TCG | 1.8 V | P | XDFN6 (Pb-Free) | 3000 / Tape & Reel |
| NCP702MX28TCG | 2.8 V | 2 | | |
| NCP702MX30TCG | 3.0 V | 3 | | |
| NCP702MX33TCG | 3.3 V | 4 | | |
| NCP702SN18T1G | 1.8 V | A7J | TSOP5 (Pb-Free) | 3000 / Tape & Reel |
| NCP702SN28T1G | 2.8 V | AD2 | | |
| NCP702SN30T1G | 3.0 V | A7R | | |
| NCP702SN31T1G | 3.1 V | A7P | | |
| NCP702SN33T1G | 3.3 V | A7T | | |

†For information on tape and reel specifications, including part orientation and tape sizes, please refer to our Tape and Reel Packaging Specifications Brochure, BRD8011/D.

NCP702

PACKAGE DIMENSIONS

XDFN6 1.5x1.5, 0.5P CASE 711AE ISSUE A

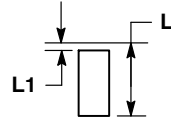
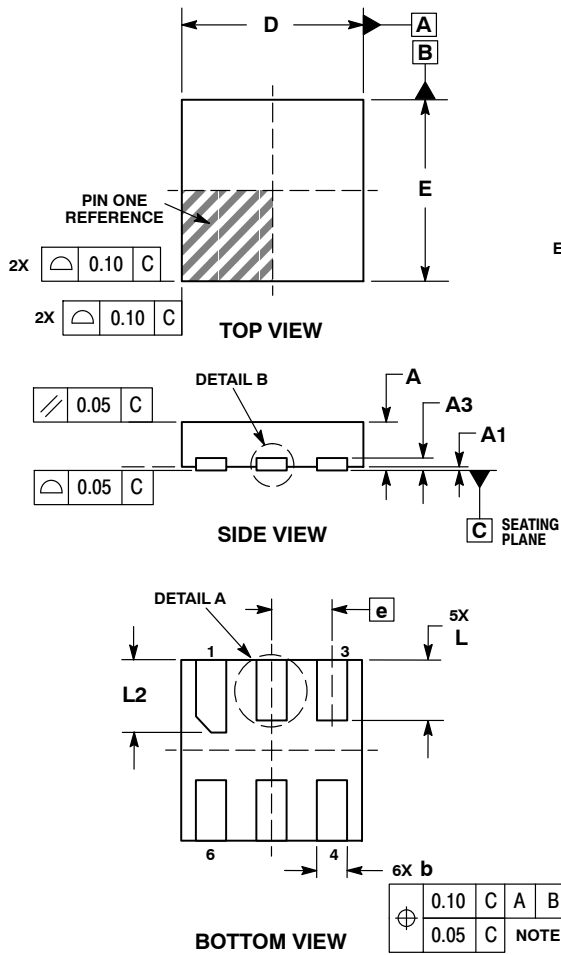

DETAIL A
ALTERNATE TERMINAL
CONSTRUCTIONS

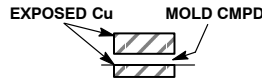

DETAIL B
ALTERNATE
CONSTRUCTIONS

NOTES:

1. DIMENSIONING AND TOLERANCING PER ASME Y14.5M, 1994.
2. CONTROLLING DIMENSION: MILLIMETERS.
3. DIMENSION b APPLIES TO PLATED TERMINAL AND IS MEASURED BETWEEN 0.10 AND 0.20mm FROM TERMINAL TIP.

| DIM | MILLIMETERS | |
|-----|-------------|------|
| | MIN | MAX |
| A | 0.35 | 0.45 |
| A1 | 0.00 | 0.05 |
| A3 | 0.13 REF | |
| b | 0.20 | 0.30 |
| D | 1.50 BSC | |
| E | 1.50 BSC | |
| e | 0.50 BSC | |
| L | 0.40 | 0.60 |
| L1 | --- | 0.15 |
| L2 | 0.50 | 0.70 |

RECOMMENDED MOUNTING FOOTPRINT*

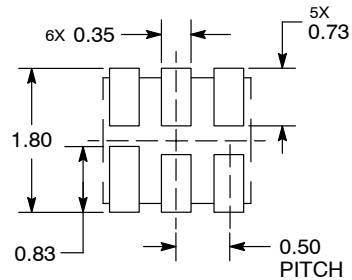

DIMENSIONS: MILLIMETERS

*For additional information on our Pb-Free strategy and soldering details, please download the ON Semiconductor Soldering and Mounting Techniques Reference Manual, SOLDERRM/D.

NCP702

PACKAGE DIMENSIONS

TSOP-5 CASE 483-02 ISSUE K

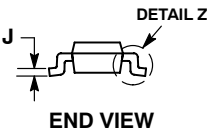
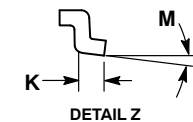
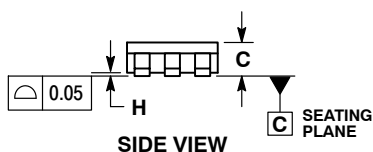
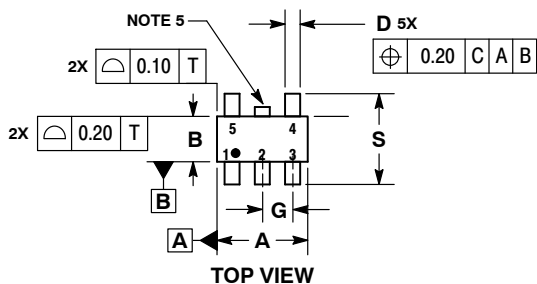

NOTES:

1. DIMENSIONING AND TOLERANCING PER ASME Y14.5M, 1994.
2. CONTROLLING DIMENSION: MILLIMETERS.
3. MAXIMUM LEAD THICKNESS INCLUDES LEAD FINISH THICKNESS. MINIMUM LEAD THICKNESS IS THE MINIMUM THICKNESS OF BASE MATERIAL.
4. DIMENSIONS A AND B DO NOT INCLUDE MOLD FLASH, PROTRUSIONS, OR GATE BURRS. MOLD FLASH, PROTRUSIONS, OR GATE BURRS SHALL NOT EXCEED 0.15 PER SIDE. DIMENSION A.
5. OPTIONAL CONSTRUCTION: AN ADDITIONAL TRIMMED LEAD IS ALLOWED IN THIS LOCATION. TRIMMED LEAD NOT TO EXTEND MORE THAN 0.2 FROM BODY.

| DIM | MILLIMETERS | |
|-----|-------------|------|
| | MIN | MAX |
| A | 3.00 BSC | |
| B | 1.50 BSC | |
| C | 0.90 | 1.10 |
| D | 0.25 | 0.50 |
| G | 0.95 BSC | |
| H | 0.01 | 0.10 |
| J | 0.10 | 0.26 |
| K | 0.20 | 0.60 |
| M | 0° | 10° |
| S | 2.50 | 3.00 |

SOLDERING FOOTPRINT*

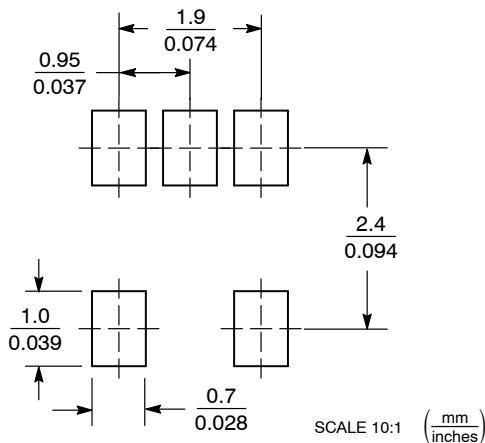

*For additional information on our Pb-Free strategy and soldering details, please download the ON Semiconductor Soldering and Mounting Techniques Reference Manual, SOLDERRM/D.

ON Semiconductor and  are registered trademarks of Semiconductor Components Industries, LLC (SCILLC). SCILLC owns the rights to a number of patents, trademarks, copyrights, trade secrets, and other intellectual property. A listing of SCILLC's product/patent coverage may be accessed at www.onsemi.com/site/pdf/Patent-Marking.pdf. SCILLC reserves the right to make changes without further notice to any products herein. SCILLC makes no warranty, representation or guarantee regarding the suitability of its products for any particular purpose, nor does SCILLC assume any liability arising out of the application or use of any product or circuit, and specifically disclaims any and all liability, including without limitation special, consequential or incidental damages. "Typical" parameters which may be provided in SCILLC data sheets and/or specifications can and do vary in different applications and actual performance may vary over time. All operating parameters, including "Typicals" must be validated for each customer application by customer's technical experts. SCILLC does not convey any license under its patent rights nor the rights of others. SCILLC products are not designed, intended, or authorized for use as components in systems intended for surgical implant into the body, or other applications intended to support or sustain life, or for any other application in which the failure of the SCILLC product could create a situation where personal injury or death may occur. Should Buyer purchase or use SCILLC products for any such unintended or unauthorized application, Buyer shall indemnify and hold SCILLC and its officers, employees, subsidiaries, affiliates, and distributors harmless against all claims, costs, damages, and expenses, and reasonable attorney fees arising out of, directly or indirectly, any claim of personal injury or death associated with such unintended or unauthorized use, even if such claim alleges that SCILLC was negligent regarding the design or manufacture of the part. SCILLC is an Equal Opportunity/Affirmative Action Employer. This literature is subject to all applicable copyright laws and is not for resale in any manner.

PUBLICATION ORDERING INFORMATION

LITERATURE FULFILLMENT:

Literature Distribution Center for ON Semiconductor
P.O. Box 5163, Denver, Colorado 80217 USA
Phone: 303-675-2175 or 800-344-3860 Toll Free USA/Canada
Fax: 303-675-2176 or 800-344-3867 Toll Free USA/Canada
Email: orderlit@onsemi.com

N. American Technical Support: 800-282-9855 Toll Free
USA/Canada
Europe, Middle East and Africa Technical Support:
Phone: 421 33 790 2910
Japan Customer Focus Center
Phone: 81-3-5817-1050



ON Semiconductor Website: www.onsemi.com

Order Literature: <http://www.onsemi.com/orderlit>

For additional information, please contact your local Sales Representative

Looking for pricing, stock, or lifecycle information?

Click below to explore more details on WIN SOURCE:

-  [View NCP702SN31T1G on WIN SOURCE](#)
-  [ON Semiconductor Information](#)

Optimize Your Supply Chain with WIN SOURCE Solutions

-  Global Sourcing Solution
-  Obsolete Management
-  Cost Control Management
-  Shortage Management
-  Alternative Solution
-  Excess Inventory Management