

GP1A038RBK/GP1A038RBKL/ GP1A038RCK/GP1A038RCKL

OPIC Photointerrupter with Encoder Function

■ Features

1. Linear encoder for reading linear scale
2. Since the multi-divided photodiode system is adopted, high-precision reading is possible even if the angle is deviated between the scale and encoder.
3. High resolution:
Resolution 150LPI (GP1A038RBK/GP1A038RBKL)
Resolution 180LPI (GP1A038RCK/GP1A038RCKL)

■ Applications

1. Printers

■ Absolute Maximum Ratings (T_a=25°C)

Parameter	Symbol	Rating	Unit
Input	*1 Forward current	I _F	50 mA
	Reverse voltage	V _R	4 V
	Supply voltage	V _{CC}	7 V
Output	Low level output current	I _{OL}	8 mA
	*1 Power dissipation	P _O	150 mW
Operating temperature	T _{opr}	-10 to +70	°C
Storage temperature	T _{stg}	-40 to +80	°C
*2 Soldering temperature	T _{sol}	260	°C

*1 The derating factors of absolute maximum ratings due to ambient temperature are shown in Fig.2 to 3

*2 For 5s

■ Internal connection diagram

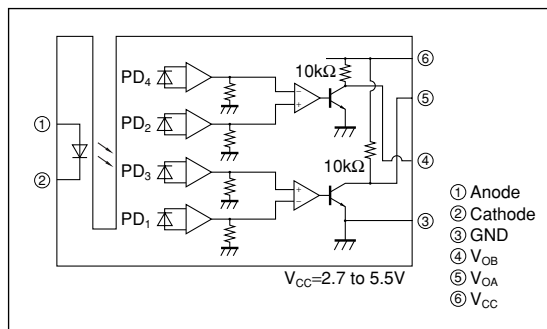

■ Outline Dimensions (Unit : mm)

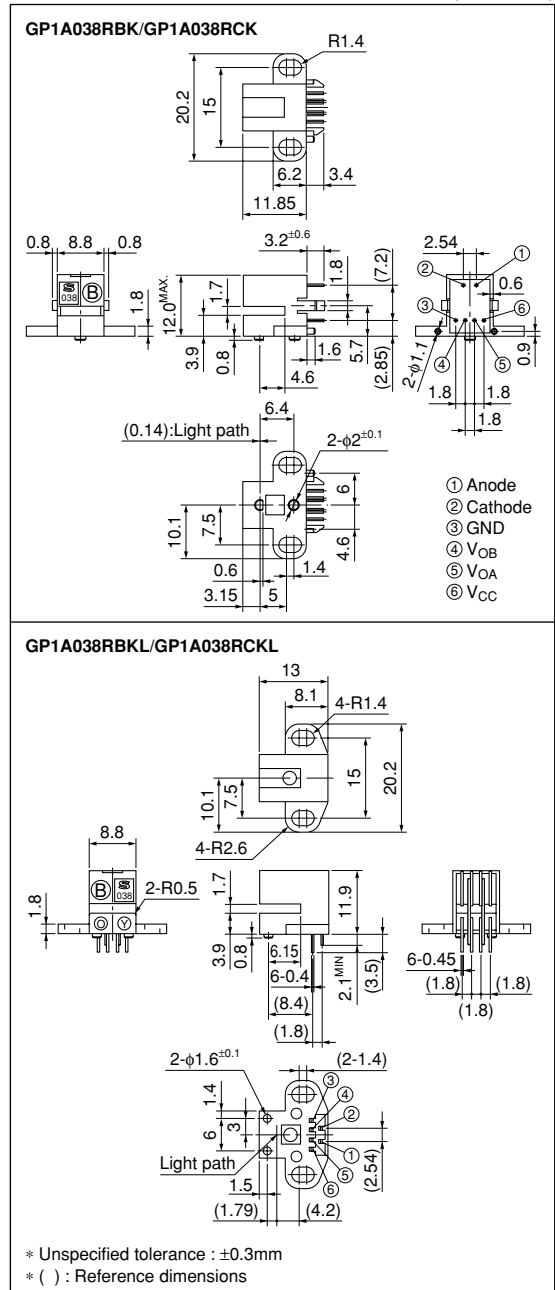

■ Electro-optical Characteristics

(T_a=25°C)

Parameter		Symbol	Conditions	MIN.	TYP.	MAX.	Unit
Input	Forward voltage	V _F	I _F =11mA	-	1.3	1.5	V
	Reverse current	I _R	V _R =1V	-	-	100	μA
Output	Operating supply voltage	V _{CC}	-	2.7	5.0	5.5	V
	Low level output voltage	V _{OL}	V _{CC} =2.7 to 5.5V, I _F =11mA, I _{OL} =8mA	-	-	0.4	V
	High level output voltage	V _{OH}	V _{CC} =2.7 to 5.5V, I _F =11mA	V _{CC} -0.3	-	-	V
	Supply current	I _{CC}	V _{CC} =2.7 to 5.5V, I _F =11mA, A and B low level	-	-	5	mA
*1 Transfer characteristics	Duty ratio	D _A D _B	V _{CC} =2.7 to 5.5V, I _F =11mA, f=10kHz, Z=0.3 ^{+0.7} _{-0.2} mm	35	50	65	%
	Phase difference	θ _{AB1 to 4}		45	90	135	°
	Response time	t _r		-	1.0	2.0	μs
		t _f		-	1.0	2.0	μs
Response frequency	f _{max}	V _{CC} =2.7 to 5.5V, I _F =11mA, Z=0.3 ^{+0.7} _{-0.2} mm	-	-	20	kHz	

*1 Refer to the measuring condition. The values of transfer characteristics do not include an error of linear scale. Z is the distance between scale face and holder on the detector side.

Fig.1 Output Waveforms

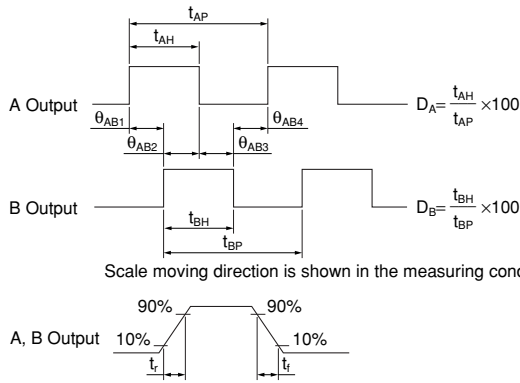

Scale moving direction is shown in the measuring condition (Refer to Fig.4).

Fig.2 Forward Current vs. Ambient Temperature

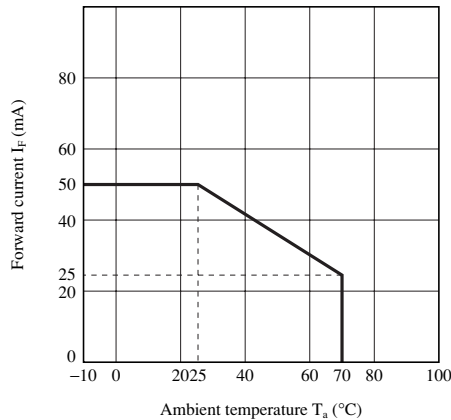

Fig.3 Output Power Dissipation vs. Ambient Temperature

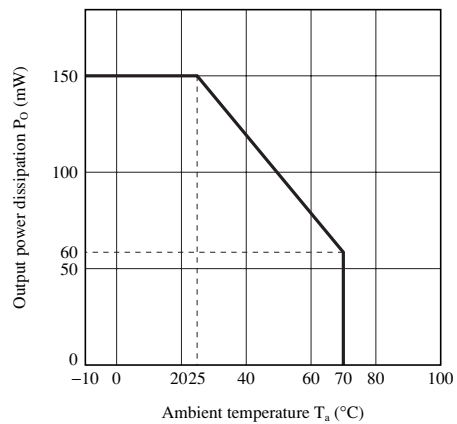
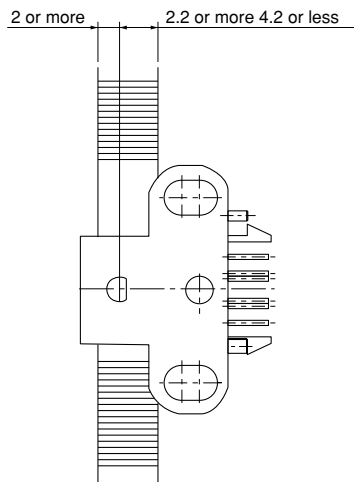
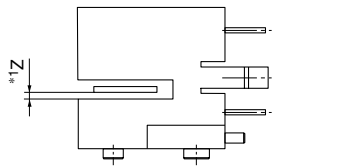
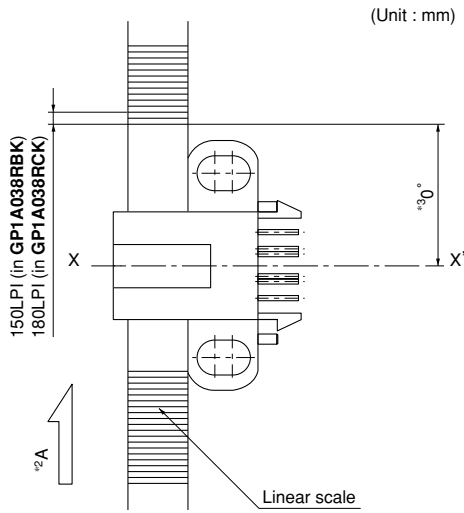

Fig.4 Measuring Condition



*1 Distance between scale face and holder on the detector side

*2 Scale moving direction

*3 X-X' is the line which is through the center of holder positioning pin, and it is parallel to the scale slit.

NOTICE

- The circuit application examples in this publication are provided to explain representative applications of SHARP devices and are not intended to guarantee any circuit design or license any intellectual property rights. SHARP takes no responsibility for any problems related to any intellectual property right of a third party resulting from the use of SHARP's devices.
- Contact SHARP in order to obtain the latest device specification sheets before using any SHARP device. SHARP reserves the right to make changes in the specifications, characteristics, data, materials, structure, and other contents described herein at any time without notice in order to improve design or reliability. Manufacturing locations are also subject to change without notice.
- Observe the following points when using any devices in this publication. SHARP takes no responsibility for damage caused by improper use of the devices which does not meet the conditions and absolute maximum ratings to be used specified in the relevant specification sheet nor meet the following conditions:
 - (i) The devices in this publication are designed for use in general electronic equipment designs such as:
 - Personal computers
 - Office automation equipment
 - Telecommunication equipment [terminal]
 - Test and measurement equipment
 - Industrial control
 - Audio visual equipment
 - Consumer electronics
 - (ii) Measures such as fail-safe function and redundant design should be taken to ensure reliability and safety when SHARP devices are used for or in connection with equipment that requires higher reliability such as:
 - Transportation control and safety equipment (i.e., aircraft, trains, automobiles, etc.)
 - Traffic signals
 - Gas leakage sensor breakers
 - Alarm equipment
 - Various safety devices, etc.
 - (iii) SHARP devices shall not be used for or in connection with equipment that requires an extremely high level of reliability and safety such as:
 - Space applications
 - Telecommunication equipment [trunk lines]
 - Nuclear power control equipment
 - Medical and other life support equipment (e.g., scuba).
- Contact a SHARP representative in advance when intending to use SHARP devices for any "specific" applications other than those recommended by SHARP or when it is unclear which category mentioned above controls the intended use.
- If the SHARP devices listed in this publication fall within the scope of strategic products described in the Foreign Exchange and Foreign Trade Control Law of Japan, it is necessary to obtain approval to export such SHARP devices.
- This publication is the proprietary product of SHARP and is copyrighted, with all rights reserved. Under the copyright laws, no part of this publication may be reproduced or transmitted in any form or by any means, electronic or mechanical, for any purpose, in whole or in part, without the express written permission of SHARP. Express written permission is also required before any use of this publication may be made by a third party.
- Contact and consult with a SHARP representative if there are any questions about the contents of this publication.

Looking for pricing, stock, or lifecycle information?

Click below to explore more details on WIN SOURCE:

- ⊖ [View GP1A038RCK0F](#) on WIN SOURCE
- ⊖ [Sharp Microelectronics](#) Information

Optimize Your Supply Chain with WIN SOURCE Solutions

- ✓ Global Sourcing Solution
- ✓ Obsolete Management
- ✓ Cost Control Management
- ✓ Shortage Management
- ✓ Alternative Solution
- ✓ Excess Inventory Management