



**THE DATASHEET OF
MAX8891EXK25+T**



High PSRR, Low-Dropout, 150mA Linear Regulators

General Description

The MAX8891/MAX8892 low-dropout (LDO) linear regulators are designed to deliver up to 150mA continuous output current. These regulators achieve a low 120mV dropout for 120mA load current.

The MAX8891 only requires an input/output capacitor, hence achieving the smallest PCB area. The MAX8892's output voltage can be adjusted with an external divider.

The MAX8891 is preset to a variety of voltages in the 1.5V to 4.5V range. Designed with a p-channel MOSFET series pass transistor, the MAX8891/MAX8892 maintain very low ground current (40µA).

The regulators are designed and optimized to work with low-value, low-cost ceramic capacitors. The MAX8891/MAX8892 require only 1µF (typ) of output capacitance for stability with any load. When disabled, current consumption drops to below 1µA.

These regulators are available in a tiny 5-pin SC70 package.

Applications

- Cellular and Cordless Phones
- PDA and Palmtop Computers
- Base Stations
- Bluetooth Portable Radios and Accessories
- Wireless LANs
- Digital Cameras
- Personal Stereos
- Portable and Battery-Powered Equipment

Output Voltage Selector Guide appears at end of data sheet.

Pin Configuration

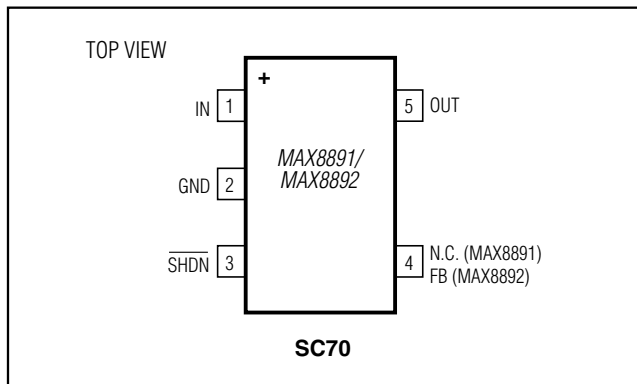

Features

- ◆ Space-Saving SC70 Package
- ◆ 65dB PSRR at 10kHz
- ◆ 120mV Dropout at 120mA Load
- ◆ Stable with 1µF Ceramic Capacitor for Any Load
- ◆ Guaranteed 150mA Output
- ◆ Only Need Input and Output Capacitors (MAX8891)
- ◆ Output Voltages: 1.5V, 1.8V, 2.5V, 2.6V, 2.7V, 2.8V, 2.85V, 3V, 3.3V, 4.5V (MAX8891) and Adjustable (MAX8892)
- ◆ Low 40µA Ground Current
- ◆ Excellent Load/Line Transient
- ◆ Overcurrent and Thermal Protection

Ordering Information

PART*	TEMP RANGE	PIN-PACKAGE
MAX8891EXKxy+T	-40°C to +85°C	5 SC70
MAX8891EXKxy/V+T	-40°C to +85°C	5 SC70
MAX8892EXK+T	-40°C to +85°C	5 SC70

*xy is the output voltage code (see Output Voltage Selector Guide). Other versions between 1.5V and 4.5V are available in 100mV increments. Contact factory for other versions.
 + Denotes a lead(Pb)-free/RoHS-compliant package.
 /V denotes an automotive qualified part.

Typical Operating Circuits

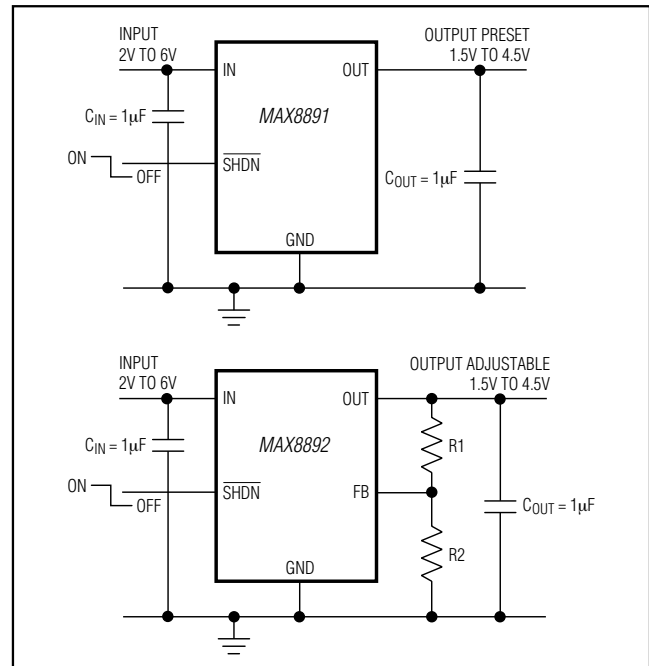

MAX8891/MAX8892

High PSRR, Low-Dropout, 150mA Linear Regulators

ABSOLUTE MAXIMUM RATINGS

IN to GND-0.3V to +7V
 Output Short-Circuit Duration.....Continuous
 OUT, SHDN to GND-0.3V to (V_{IN} + 0.3V)
 FB, BP, N.C. to GND-0.3V to (V_{OUT} + 0.3V)
 Continuous Power Dissipation (T_A = +70°C)
 5-Pin SC70 (derate 3.1mW/°C above +70°C).....0.247W

Operating Temperature Range-40°C to +85°C
 Junction Temperature.....+150°C
 Storage Temperature Range-65°C to +150°C
 Lead Temperature (soldering, 10s).....+300°C
 Soldering Temperature (reflow).....+260°C

Stresses beyond those listed under "Absolute Maximum Ratings" may cause permanent damage to the device. These are stress ratings only, and functional operation of the device at these or any other conditions beyond those indicated in the operational sections of the specifications is not implied. Exposure to absolute maximum rating conditions for extended periods may affect device reliability.

PACKAGE THERMAL CHARACTERISTICS (Note 1)

SC70

Junction-to-Ambient Thermal Resistance (θ_{JA})324°C/W
 Junction-to-Case Thermal Resistance (θ_{JC})115°C/W

Note 1: Package thermal resistances were obtained using the method described in JEDEC specification JESD51-7, using a four-layer board. For detailed information on package thermal considerations, refer to www.maximintegrated.com/thermal-tutorial.

ELECTRICAL CHARACTERISTICS

(V_{IN} = V_{OUT} + 0.5V, T_A = -40°C to +85°C, unless otherwise noted. C_{IN} = 1μF, C_{OUT} = 1μF. Typical values are at T_A = +25°C; the MAX8892 is tested with 2.45V output, unless otherwise noted.) (Note 2)

PARAMETER	SYMBOL	CONDITIONS	MIN	TYP	MAX	UNITS
Input Voltage Range	V _{IN}		2		6	V
Output Voltage Accuracy		I _{OUT} = 100μA to 80mA	-3		+3	%
Maximum Output Current	I _{OUT}		150			mA
Current Limit	I _{LIM}	I _{OUT} = 90% of nominal value		200		mA
Dropout Voltage (Note 3)		V _{OUT} ≥ 3V, I _{OUT} = 120mA		120		mV
		2.5V ≤ V _{OUT} < 3V, I _{OUT} = 120mA		135		
		2V ≤ V _{OUT} < 2.5V, I _{OUT} = 120mA		180		
Ground Current	I _Q	I _{OUT} = 0.05mA		40		μA
Line Regulation	V _{LNR}	V _{IN} = (V _{OUT} + 0.5V) to 6V, I _{OUT} = 0.1mA		0.001		%/V
Load Regulation	V _{LDR}	I _{OUT} = 1mA to 80mA		0.003		%/mA
Shutdown Supply Current	I _{SHDN}	V _{SHDN} = 0V	T _A = +25°C	0.003	1	μA
			T _A = +85°C	0.05		
Ripple Rejection	PSRR	f = 10kHz, I _{OUT} = 10mA		65		dB
Output Noise Voltage (RMS)		f = 100Hz to 100kHz, I _{LOAD} = 80mA		230		μV
SHDN Logic-Low Level		V _{IN} = 2V to 6V			0.4	V
SHDN Logic-High Level		V _{IN} = 2V to 6V	1.5			V
SHDN Input Bias Current		V _{IN} = 6V, V _{SHDN} = 0V or 6V	T _A = +25°C			μA
			T _A = +85°C	0.01		
FB Input Bias Current (MAX8892)		V _{IN} = 6V, V _{FB} = 1.3V	T _A = +25°C	0.006	0.1	μA
			T _A = +85°C	0.01		
Thermal Shutdown				160		°C
Thermal-Shutdown Hysteresis				10		°C

Note 2: Limits are 100% tested at T_A = +25°C. Limits over operating temperature range are guaranteed by design.

Note 3: Dropout is defined as V_{IN} - V_{OUT} when V_{OUT} is 100mV below the value of V_{OUT} for V_{IN} = V_{OUT} + 0.5V.

MAX8891/MAX8892

High PSRR, Low-Dropout, 150mA Linear Regulators

Typical Operating Characteristics

($V_{IN} = V_{OUT} + 0.5V$, $C_{IN} = 1\mu F$, $C_{OUT} = 1\mu F$, $T_A = +25^\circ C$, unless otherwise noted.)

OUTPUT VOLTAGE vs. INPUT VOLTAGE

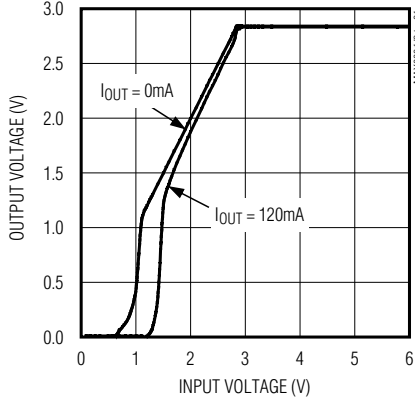

OUTPUT VOLTAGE ACCURACY vs. LOAD CURRENT

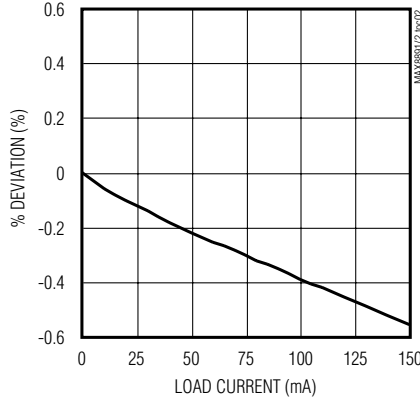

OUTPUT VOLTAGE ACCURACY vs. TEMPERATURE

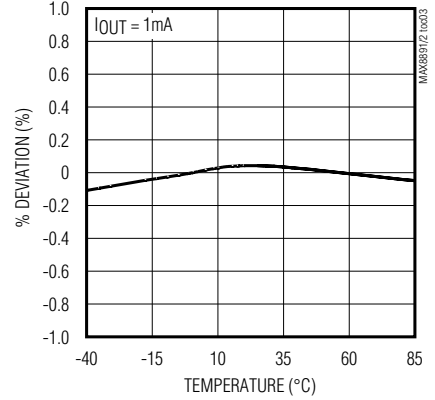

DROPOUT VOLTAGE vs. LOAD CURRENT

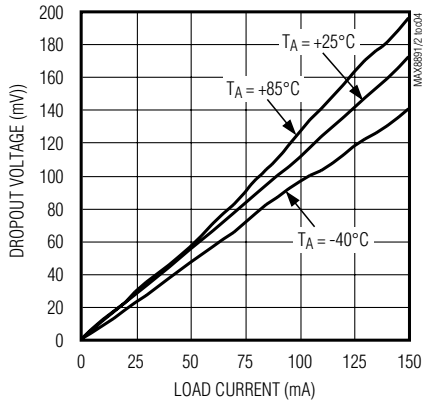

DROPOUT VOLTAGE vs. OUTPUT VOLTAGE

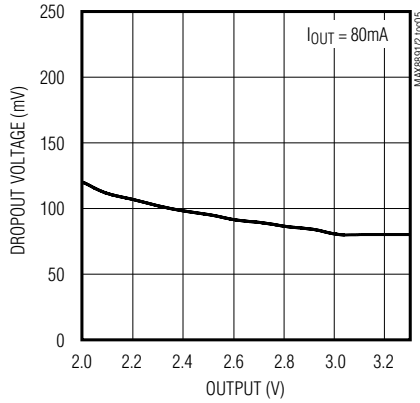

GROUND PIN CURRENT vs. INPUT VOLTAGE

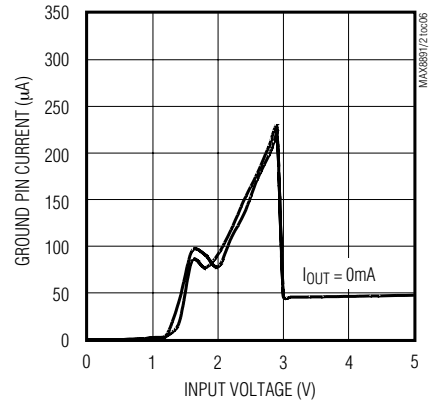

GROUND PIN CURRENT vs. LOAD CURRENT

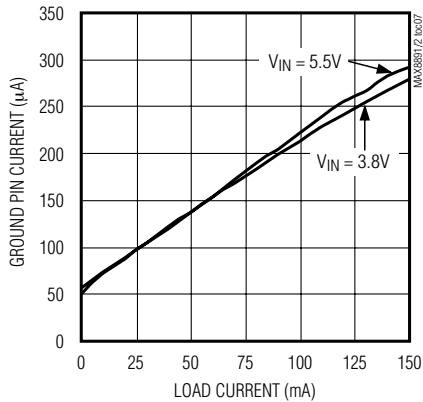

GROUND PIN CURRENT vs. TEMPERATURE

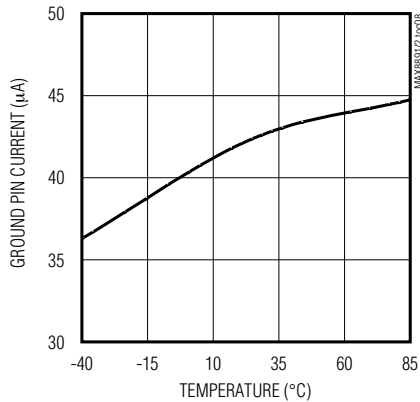

PSRR vs. FREQUENCY

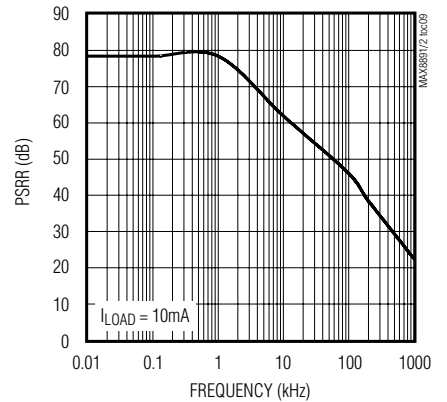

MAX8891/MAX8892

High PSRR, Low-Dropout, 150mA Linear Regulators

Typical Operating Characteristics (continued)

($V_{IN} = V_{OUT} + 0.5V$, $C_{IN} = 1\mu F$, $C_{OUT} = 1\mu F$, $T_A = +25^\circ C$, unless otherwise noted.)

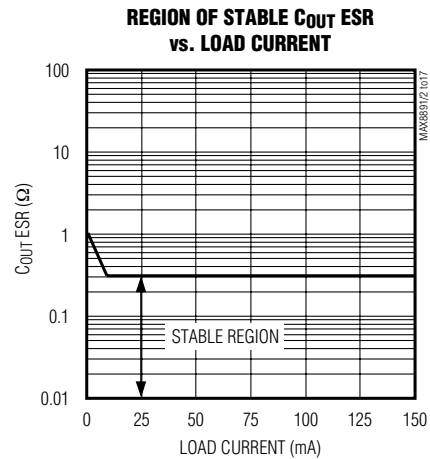
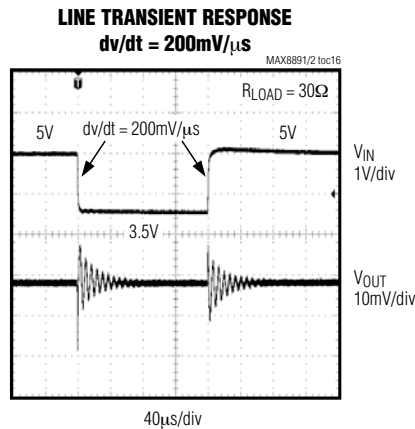
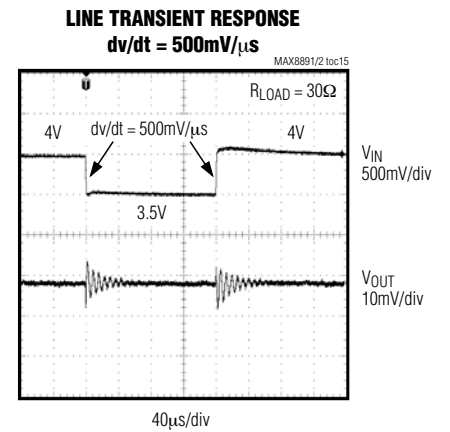
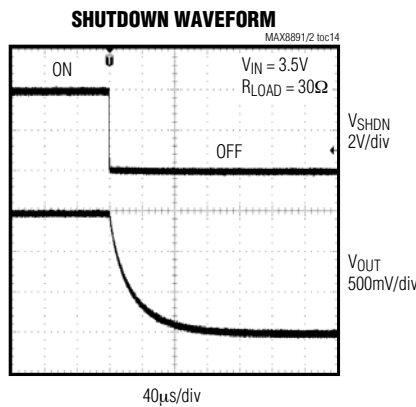
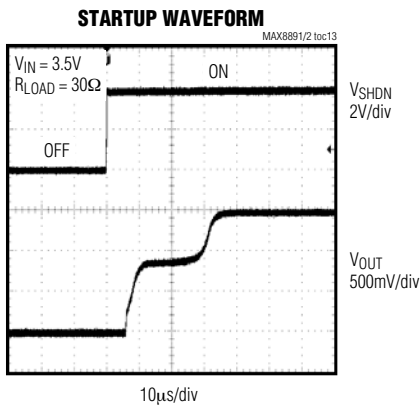
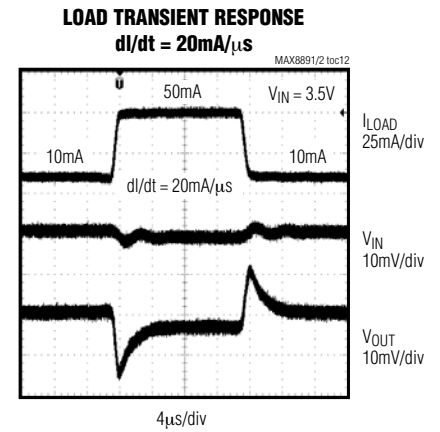
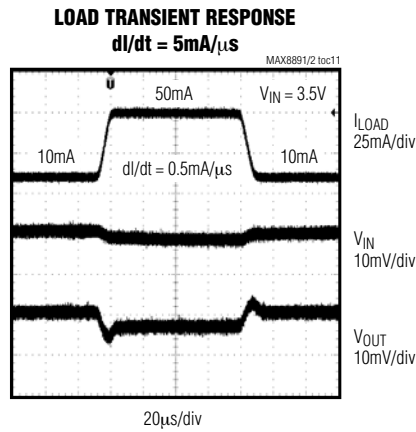
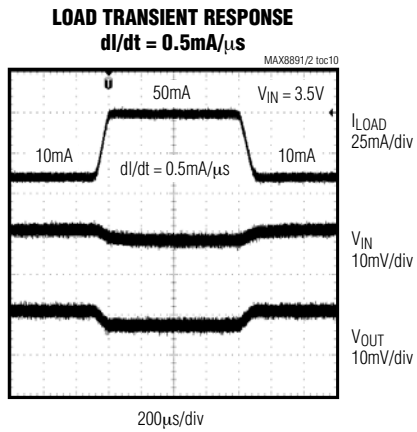

MAX8891/MAX8892

High PSRR, Low-Dropout, 150mA Linear Regulators

Pin Description

PIN		NAME	FUNCTION
MAX8891	MAX8892		
1	1	IN	Unregulated Input Supply
2	2	GND	Ground
3	3	$\overline{\text{SHDN}}$	Shutdown. Pull low to disable the regulator.
—	4	FB	Adjustable Output Feedback Point
4	—	N.C.	Not Internally Connected
5	5	OUT	Regulated Output Voltage. Bypass with a capacitor to GND. See the <i>Capacitor Selection and Regulator Stability</i> section for more details.

Detailed Description

The MAX8891/MAX8892 are low-dropout, low-quiescent current linear regulators designed for space-restricted applications. The parts are available with preset output voltages ranging from 1.5V to 4.5V in 100mV increments. These devices can supply loads up to 150mA. As shown in the *Functional Diagram*, the MAX8891 consists of an innovative bandgap core, error amplifier, p-channel pass transistor, and internal feedback voltage-divider. The MAX8892 allows for adjustable output with an external feedback network. Additional blocks include a current limiter, thermal sensor, and shutdown logic.

The 1.225V bandgap reference is connected to the error amplifier's inverting input. The error amplifier compares this reference with the feedback voltage and amplifies the difference. If the feedback voltage is lower than the reference voltage, the pass-transistor gate is pulled low. This allows more current to pass to the output and increases the output voltage. If the feedback voltage is too high, the pass transistor gate is pulled high, allowing less current to pass to the output. The output voltage is fed back through an internal (external for the MAX8892) resistor voltage-divider connected to the OUT pin.

Internal P-Channel Pass Transistor

The MAX8891/MAX8892 feature a 1 Ω (typ) p-channel MOSFET pass transistor. This provides several advantages over similar designs using a PNP pass transistor, including longer battery life. The p-channel MOSFET requires no base drive, which considerably reduces quiescent current. PNP-based regulators waste considerable current in dropout when the pass transistor saturates. They also use high base-drive current under

heavy loads. The MAX8891/MAX8892 do not suffer from these problems and consume only 40 μ A of quiescent current in light load and 220 μ A in dropout (see the *Typical Operating Characteristics*).

Output Voltage Selection

The MAX8891 is supplied with factory-set output voltages from 1.5V to 4.5V, in 100mV increments (see the *Ordering Information*). The MAX8892 features a user-adjustable output through an external feedback network (see the *Typical Operating Circuits*).

To set the output of the MAX8892, use the following equation:

$$R1 = R2 \times \left(\frac{V_{\text{OUT}}}{V_{\text{REF}}} - 1 \right)$$

where R2 is chosen to be less than 240k Ω and VREF = 1.225V. Use 1% or better resistors.

Shutdown

The MAX8891/MAX8892 feature a low-power shutdown mode that reduces quiescent current less than 1 μ A. Driving $\overline{\text{SHDN}}$ low disables the voltage reference, error amplifier, gate-drive circuitry, and pass transistor (see the *Functional Diagram*), and the device output enters a high-impedance state. Connect $\overline{\text{SHDN}}$ to IN for normal operation.

Current Limit

The MAX8891/MAX8892 include a current limiter, which monitors and controls the pass transistor's gate voltage, limiting the output current to 200mA. The output can be continuously shorted to ground without damaging the part.

MAX8891/MAX8892

High PSRR, Low-Dropout, 150mA Linear Regulators

Thermal-Overload Protection

Thermal-overload protection limits total power dissipation in the MAX8891/MAX8892. When the junction temperature exceeds $T_J = +160^\circ\text{C}$, the thermal sensor signals the shutdown logic, turning off the pass transistor and allowing the IC to cool down. The thermal sensor turns the pass transistor on again after the IC's junction temperature drops by 10°C , resulting in a pulsed output during continuous thermal-overload conditions.

Thermal-overload protection is designed to protect the MAX8891/MAX8892 in the event of a fault condition. For continual operation, do not exceed the absolute maximum junction temperature rating of $T_J = +150^\circ\text{C}$.

Operating Region and Power Dissipation

The MAX8891/MAX8892 maximum power dissipation depends on the thermal resistance of the case and circuit board, the temperature difference between the die junction and ambient, and the rate of airflow. The power dissipation across the device is:

$$P = I_{\text{OUT}} (V_{\text{IN}} - V_{\text{OUT}})$$

The maximum power dissipation is:

$$P_{\text{MAX}} = (T_J - T_A) / (\theta_{\text{JC}} + \theta_{\text{CA}})$$

where $T_J - T_A$ is the temperature difference between the MAX8891/MAX8892 die junction and the surrounding air, θ_{JC} is the thermal resistance of the package, and θ_{CA} is the thermal resistance through the PCB, copper traces, and other materials to the surrounding air.

The GND pin of the MAX8891/MAX8892 performs the dual function of providing an electrical connection to ground and channeling heat away. Connect the GND pin to ground using a large pad or ground plane.

Applications Information

Capacitor Selection and Regulator Stability

Use a $1\mu\text{F}$ capacitor on the MAX8891/MAX8892 input and a $1\mu\text{F}$ capacitor on the output. Larger input capacitor values and lower ESRs provide better noise rejection and line-transient response. Reduce output noise and improve load-transient response, stability, and power-supply rejection by using large output capacitors. Note that some ceramic dielectrics exhibit large capacitance and ESR variation with temperature. With dielectrics such as Z5U and Y5V, it may be necessary to use a $2.2\mu\text{F}$ or larger output capacitor to ensure stability at temperatures below -10°C . With X7R or X5R dielectrics, $1\mu\text{F}$ is sufficient at all operating temperatures. A graph of the region of stable C_{OUT} ESR vs. load current is shown in the *Typical Operating Characteristics*.

PSRR and Transient Response

The MAX8891/MAX8892 are designed to deliver high PSRR as well as low dropout and low quiescent currents in battery-powered systems. The MAX8891/MAX8892 power-supply rejection is 65dB at 10kHz.

When operating from sources other than batteries, improved supply-noise rejection and transient response can be achieved by increasing the values of the input and output bypass capacitors, and through passive filtering techniques. The *Typical Operating Characteristics* show the MAX8891/MAX8892 line- and load-transient responses.

Dropout Voltage

A regulator's minimum dropout voltage determines the lowest usable supply voltage. In battery-powered systems, this determines the useful end-of-life battery voltage. Because the MAX8891/MAX8892 use a p-channel MOSFET pass transistor, their dropout voltage is a function of drain-to-source on-resistance ($R_{\text{DS(ON)}}$) multiplied by the load current (see the *Typical Operating Characteristics*).

MAX8891/MAX8892

High PSRR, Low-Dropout, 150mA Linear Regulators

Functional Diagram

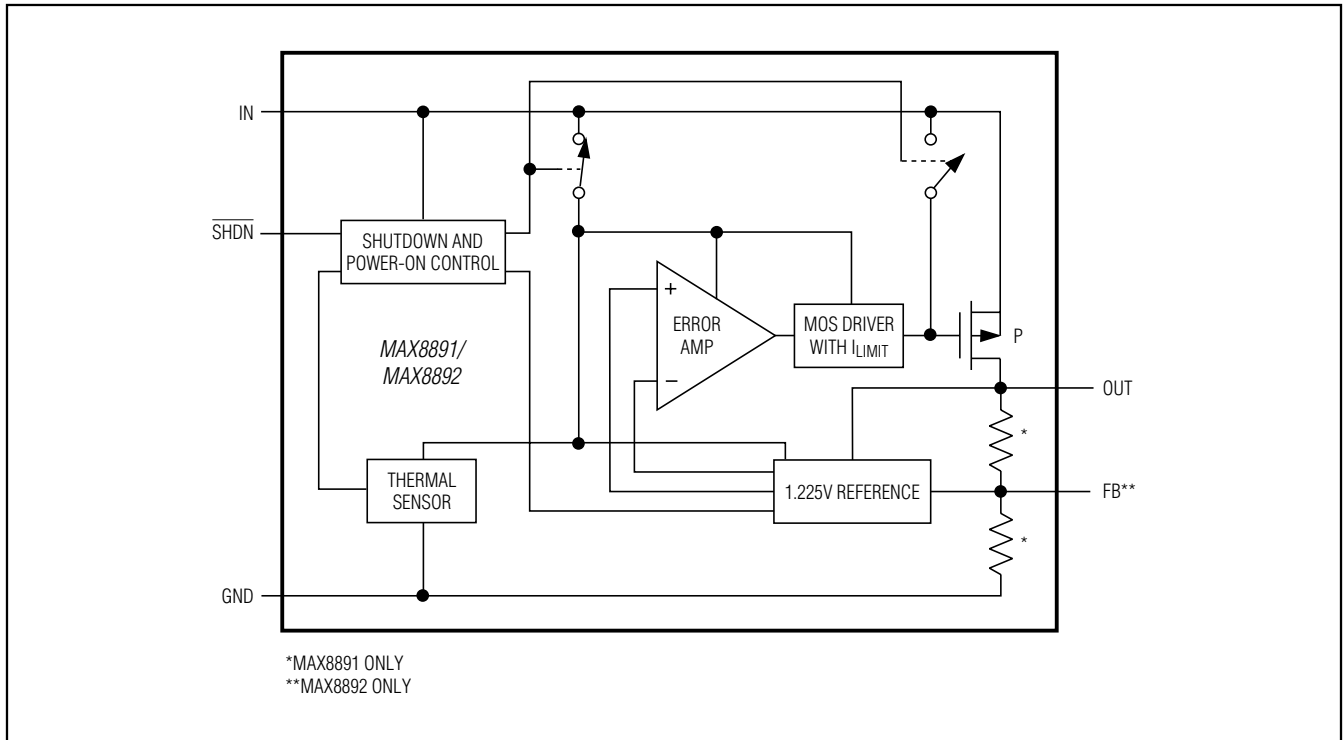

Output Voltage Selector Guide

PART	V _{OUT} (V)	TOP MARK
MAX8891EXK15+T	1.5	ATI
MAX8891EXK18+T	1.8	ATJ
MAX8891EXK25+T	2.5	ATL
MAX8891EXK26+T	2.6	ATM
MAX8891EXK28+T	2.8	ATO
MAX8891EXK29+T	2.85	ATP
MAX8891EXK89+T	2.9	ATV
MAX8891EXK30+T	3.0	ATQ
MAX8891EXK31+T	3.1	ATR
MAX8891EXK33+T	3.3	ATS
MAX8891EXK33/V+T	3.3	AUR
MAX8891EXK45+T	4.5	ATU
MAX8892EXK+T	Adjustable	ATW

Note: Standard output voltage options, shown in **bold**, are available. Contact the factory for other output voltages between 1.5V and 4.5V. Minimum order quantity is 15,000 units.

Chip Information

PROCESS: BiCMOS

Package Information

For the latest package outline information and land patterns (footprints), go to www.maximintegrated.com/packages. Note that a "+", "#", or "-" in the package code indicates RoHS status only. Package drawings may show a different suffix character, but the drawing pertains to the package regardless of RoHS status.

PACKAGE TYPE	PACKAGE CODE	OUTLINE NO.	LAND PATTERN NO.
5 SC70	X5+1	21-0076	90-0188

MAX8891/MAX8892

High PSRR, Low-Dropout, 150mA Linear Regulators

Revision History

REVISION NUMBER	REVISION DATE	DESCRIPTION	PAGES CHANGED
0	3/09	Initial release	—
1	12/11	Added the <i>N</i> option to the <i>Ordering Information</i> table and the <i>Output Voltage Selector Guide</i> ; updated the <i>Package Information</i> table	1, 7



Maxim Integrated cannot assume responsibility for use of any circuitry other than circuitry entirely embodied in a Maxim Integrated product. No circuit patent licenses are implied. Maxim Integrated reserves the right to change the circuitry and specifications without notice at any time. The parametric values (min and max limits) shown in the Electrical Characteristics table are guaranteed. Other parametric values quoted in this data sheet are provided for guidance.

Looking for pricing, stock, or lifecycle information?

Click below to explore more details on WIN SOURCE:

- ⊖ [View MAX8891EXK25+T on WIN SOURCE](#)
- ⊖ [Maxim Integrated Information](#)

Optimize Your Supply Chain with WIN SOURCE Solutions

- ✓ Global Sourcing Solution
- ✓ Obsolete Management
- ✓ Cost Control Management
- ✓ Shortage Management
- ✓ Alternative Solution
- ✓ Excess Inventory Management