



**THE DATASHEET OF  
BUD42DT4G**



# BUD42D

## High Speed, High Gain Bipolar NPN Transistor with Antisaturation Network and Transient Voltage Suppression Capability

The BUD42D is a state-of-the-art bipolar transistor. Tight dynamic characteristics and lot to lot minimum spread make it ideally suitable for light ballast applications.

### Features

- Free-Wheeling Diode Built-In
- Flat DC Current Gain
- Fast Switching Times and Tight Distribution
- “6 Sigma” Process Providing Tight and Reproducible Parameter Spreads
- Epoxy Meets UL 94 V-0 @ 0.125 in
- These Devices are Pb-Free and are RoHS Compliant

### Two Versions

- BUD42D-1: Case 369D for Insertion Mode
- BUD42D, BUD42DT4: Case 369C for Surface Mount Mode

### MAXIMUM RATINGS

Rating	Symbol	Value	Unit
Collector-Emitter Sustaining Voltage	$V_{CEO}$	350	Vdc
Collector-Base Breakdown Voltage	$V_{CBO}$	650	Vdc
Collector-Emitter Breakdown Voltage	$V_{CES}$	650	Vdc
Emitter-Base Voltage	$V_{EBO}$	9	Vdc
Collector Current - Continuous	$I_C$	4.0	Adc
Collector Current - Peak (Note 1)	$I_{CM}$	8.0	Adc
Base Current - Continuous	$I_B$	1.0	Adc
Base Current - Peak (Note 1)	$I_{BM}$	2.0	Adc
Total Device Dissipation @ $T_C = 25^\circ\text{C}$ Derate above $25^\circ\text{C}$	$P_D$	25 0.2	W W/ $^\circ\text{C}$
Operating and Storage Temperature	$T_J, T_{stg}$	-65 to +150	$^\circ\text{C}$
ESD - Human Body Model	HBM	3B	V
ESD - Machine Model	MM	C	V

### TYPICAL GAIN

Typical Gain @ $I_C = 1\text{ A}, V_{CE} = 2\text{ V}$	$h_{FE}$	13	-
Typical Gain @ $I_C = 0.3\text{ A}, V_{CE} = 1\text{ V}$	$h_{FE}$	16	-

Stresses exceeding Maximum Ratings may damage the device. Maximum Ratings are stress ratings only. Functional operation above the Recommended Operating Conditions is not implied. Extended exposure to stresses above the Recommended Operating Conditions may affect device reliability.

1. Pulse Test: Pulse Width = 5.0 ms, Duty Cycle = 10%10



ON Semiconductor®

<http://onsemi.com>

**4 AMPERES  
650 VOLTS, 25 WATTS  
POWER TRANSISTOR**

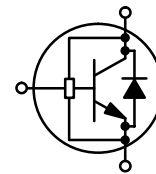

### MARKING DIAGRAMS

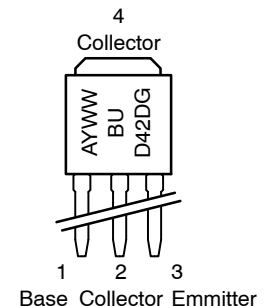
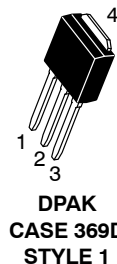
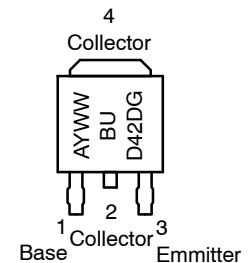

A = Assembly Location  
Y = Year  
WW = Work Week  
BUD43D = Device Code  
G = Pb-Free Package

### ORDERING INFORMATION

See detailed ordering and shipping information in the package dimensions section on page 10 of this data sheet.

# BUD42D

## THERMAL CHARACTERISTICS

Characteristic	Symbol	Value	Unit
Thermal Resistance, Junction-to-Case	$R_{\theta JC}$	5.0	$^{\circ}\text{C}/\text{W}$
Thermal Resistance, Junction-to-Ambient	$R_{\theta JA}$	71.4	$^{\circ}\text{C}/\text{W}$
Maximum Lead Temperature for Soldering Purposes: 1/8 in from Case for 5 seconds	$T_L$	260	$^{\circ}\text{C}$

## ELECTRICAL CHARACTERISTICS ( $T_C = 25^{\circ}\text{C}$ unless otherwise noted)

Characteristic	Symbol	Min	Typ	Max	Unit
----------------	--------	-----	-----	-----	------

### OFF CHARACTERISTICS

Collector-Emitter Sustaining Voltage ( $I_C = 100\text{ mA}$ , $L = 25\text{ mH}$ )	$V_{CEO(sus)}$	350	430	-	Vdc	
Collector-Base Breakdown Voltage ( $I_{CBO} = 1\text{ mA}$ )	$V_{CBO}$	650	780	-	Vdc	
Emitter-Base Breakdown Voltage ( $I_{EBO} = 1\text{ mA}$ )	$V_{EBO}$	9.0	12	-	Vdc	
Collector Cutoff Current ( $V_{CE} = \text{Rated } V_{CEO}$ , $I_B = 0$ )	$I_{CEO}$	@ $T_C = 25^{\circ}\text{C}$	-	-	100	$\mu\text{Adc}$
		@ $T_C = 125^{\circ}\text{C}$	-	-	200	
Collector Cutoff Current ( $V_{CE} = \text{Rated } V_{CES}$ , $V_{EB} = 0$ )	$I_{CES}$	@ $T_C = 25^{\circ}\text{C}$	-	-	10	$\mu\text{Adc}$
		@ $T_C = 125^{\circ}\text{C}$	-	-	200	
Emitter-Cutoff Current ( $V_{EB} = 9\text{ Vdc}$ , $I_C = 0$ )	$I_{EBO}$	-	-	100	$\mu\text{Adc}$	

### ON CHARACTERISTICS

Base-Emitter Saturation Voltage ( $I_C = 1\text{ Adc}$ , $I_B = 0.2\text{ Adc}$ )	$V_{BE(sat)}$	-	0.85	1.2	Vdc
Collector-Emitter Saturation Voltage ( $I_C = 2\text{ Adc}$ , $I_B = 0.5\text{ Adc}$ )	$V_{CE(sat)}$	-	0.2	1.0	Vdc
DC Current Gain ( $I_C = 1\text{ Adc}$ , $V_{CE} = 2\text{ Vdc}$ ) ( $I_C = 2\text{ Adc}$ , $V_{CE} = 5\text{ Vdc}$ )	$h_{FE}$	8.0 10	13 12	- -	-

### DIODE CHARACTERISTICS

Forward Diode Voltage ( $I_{EC} = 1.0\text{ Adc}$ )	$V_{EC}$	-	0.9	1.5	V
--	----------	---	-----	-----	---

### SWITCHING CHARACTERISTICS: Resistive Load (D.C. $\leq 10\%$ , Pulse Width = 40 $\mu\text{s}$ )

Turn-Off Time ( $I_C = 1.2\text{ Adc}$ , $I_{B1} = 0.4\text{ A}$ , $I_{B2} = 0.1\text{ A}$ , $V_{CC} = 300\text{ V}$ )	$T_{off}$	4.6	-	6.55	$\mu\text{s}$
Fall Time ( $I_C = 2.5\text{ Adc}$ , $I_{B1} = I_{B2} = 0.5\text{ A}$ , $V_{CC} = 150\text{ V}$ , $V_{BE} = -2\text{ V}$ )	$T_f$	-	-	0.8	$\mu\text{s}$

### DYNAMIC SATURATION VOLTAGE

Dynamic Saturation Voltage: Determined 1 $\mu\text{s}$ and 3 $\mu\text{s}$ respectively after rising $I_{B1}$ reaches 90% of final $I_{B1}$	$I_C = 400\text{ mA}$ $I_{B1} = 40\text{ mA}$ $V_{CC} = 300\text{ V}$	@ 1 $\mu\text{s}$	@ $T_C = 25^{\circ}\text{C}$ @ $T_C = 125^{\circ}\text{C}$	$V_{CE(dsat)}$	-	2.8	-	V
		@ 3 $\mu\text{s}$	@ $T_C = 25^{\circ}\text{C}$ @ $T_C = 125^{\circ}\text{C}$		-	3.2	-	
	$I_C = 1\text{ A}$ $I_{B1} = 200\text{ mA}$ $V_{CC} = 300\text{ V}$	@ 1 $\mu\text{s}$	@ $T_C = 25^{\circ}\text{C}$ @ $T_C = 125^{\circ}\text{C}$		-	0.75	-	
		@ 3 $\mu\text{s}$	@ $T_C = 25^{\circ}\text{C}$ @ $T_C = 125^{\circ}\text{C}$		-	1.3	-	
		@ 1 $\mu\text{s}$	@ $T_C = 25^{\circ}\text{C}$ @ $T_C = 125^{\circ}\text{C}$		-	2.1	-	
		@ 3 $\mu\text{s}$	@ $T_C = 25^{\circ}\text{C}$ @ $T_C = 125^{\circ}\text{C}$		-	4.7	-	
					-	0.35	-	
					-	0.6	-	

TYPICAL STATIC CHARACTERISTICS

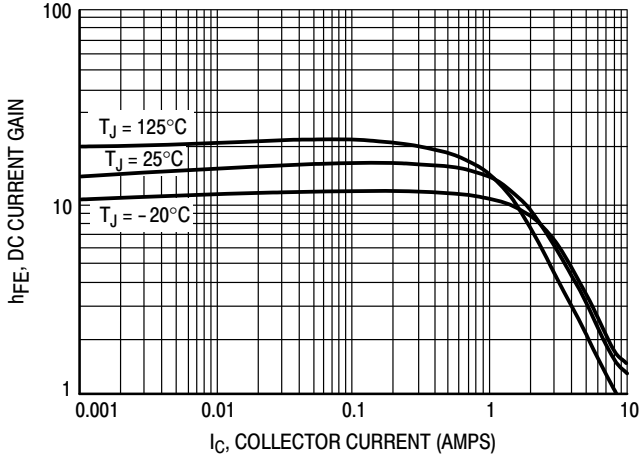

Figure 1. DC Current Gain @  $V_{CE} = 1\text{ V}$

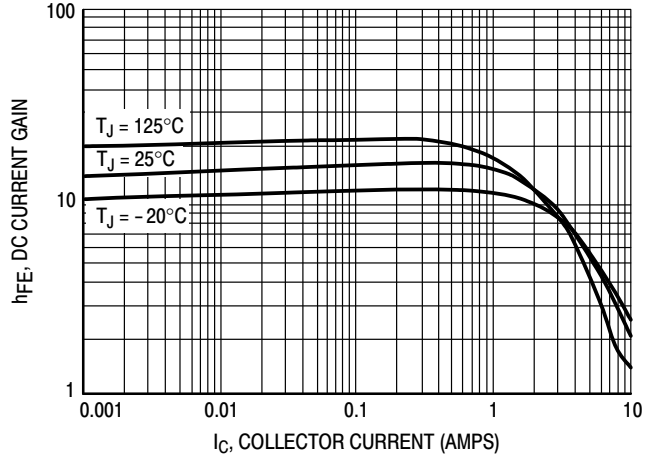

Figure 2. DC Current Gain @  $V_{CE} = 5\text{ V}$

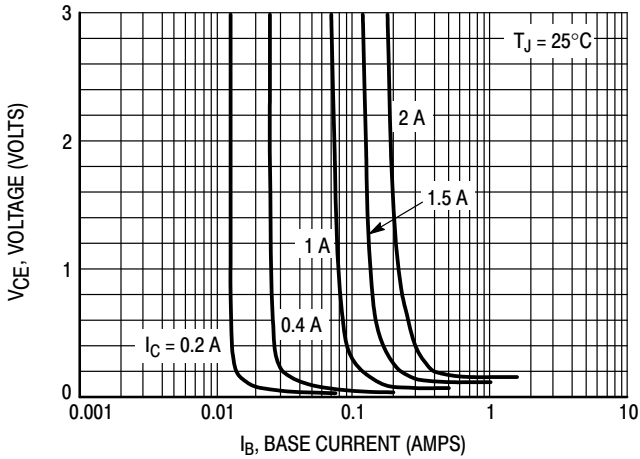

Figure 3. Collector Saturation Region

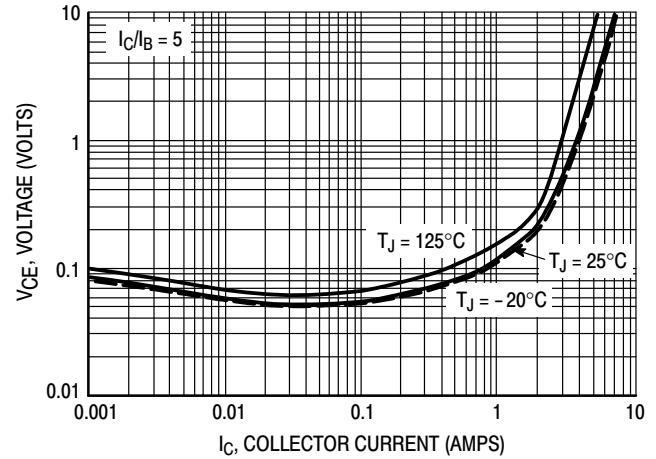

Figure 4. Collector-Emitter Saturation Voltage

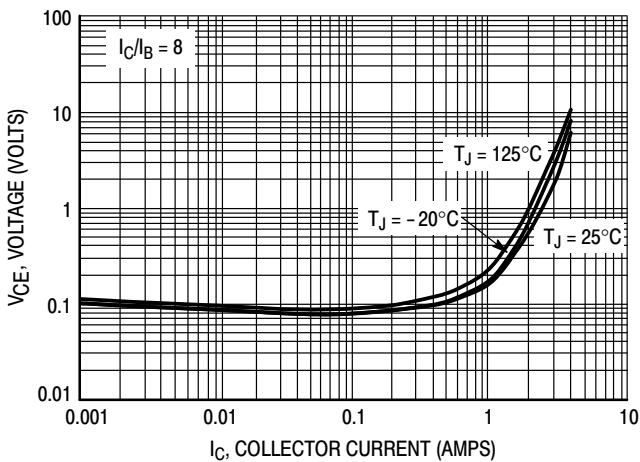

Figure 5. Collector-Emitter Saturation Voltage

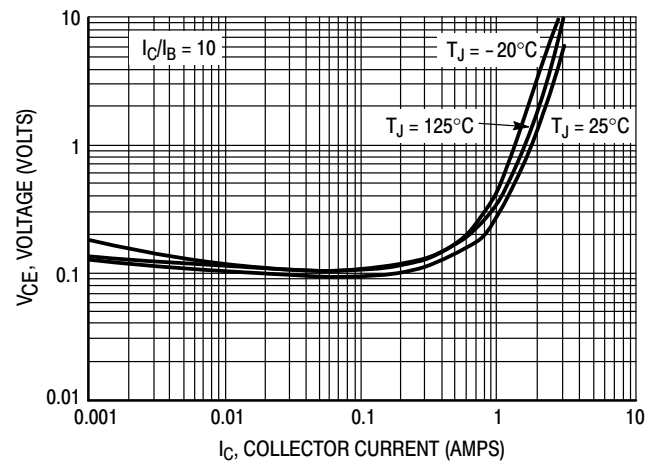

Figure 6. Collector-Emitter Saturation Voltage

# BUD42D

## TYPICAL STATIC CHARACTERISTICS

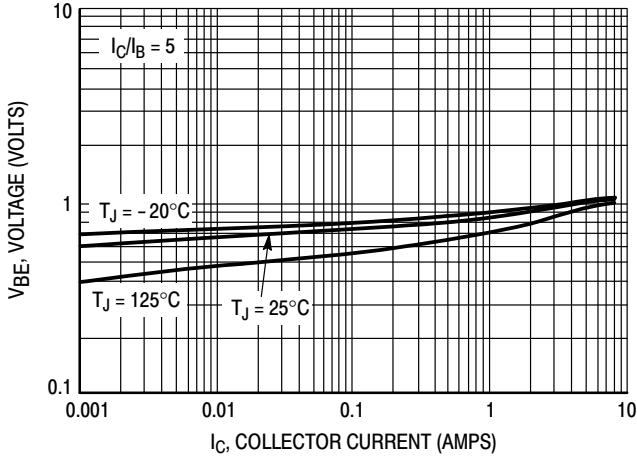

Figure 7. Base-Emitter Saturation Region

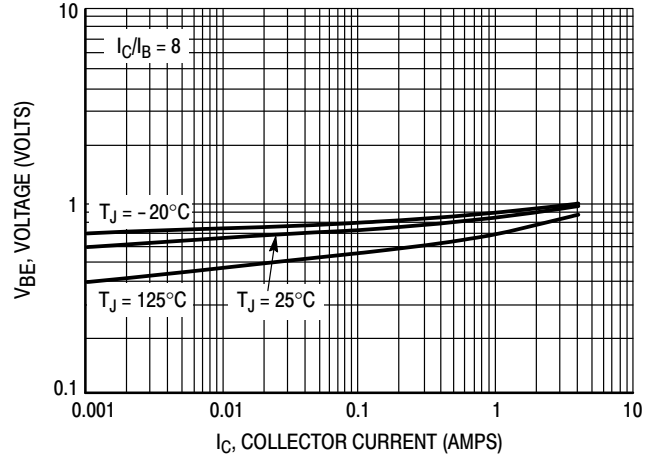

Figure 8. Base-Emitter Saturation Region

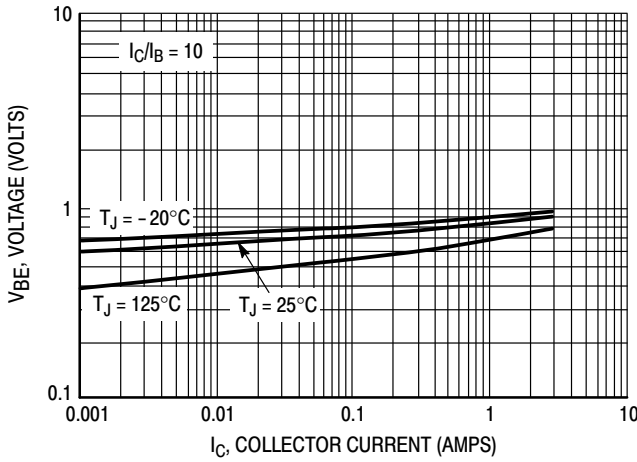

Figure 9. Base-Emitter Saturation Region

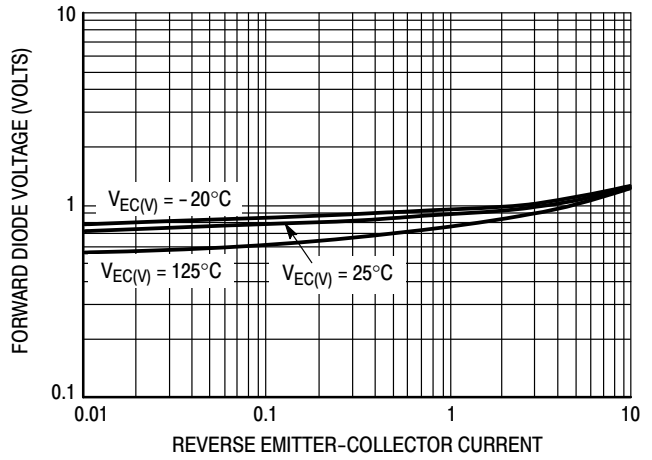

Figure 10. Forward Diode Voltage

TYPICAL SWITCHING CHARACTERISTICS

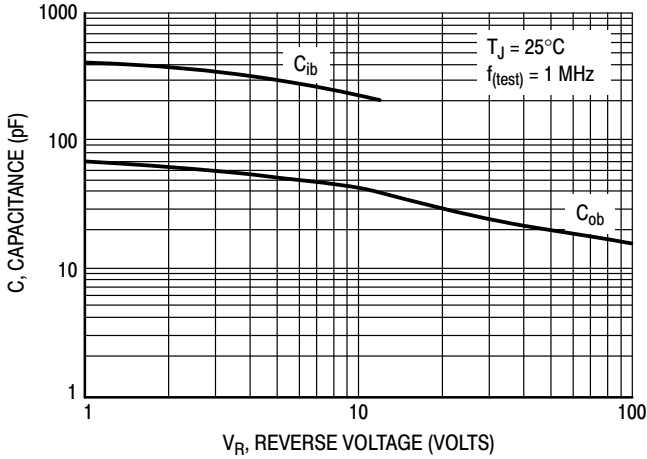

Figure 11. Capacitance

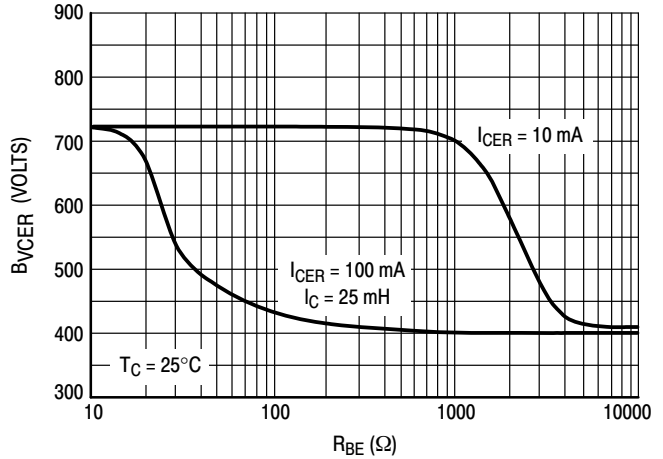

Figure 12.  $B_{VCEr} = f(R_{BE})$

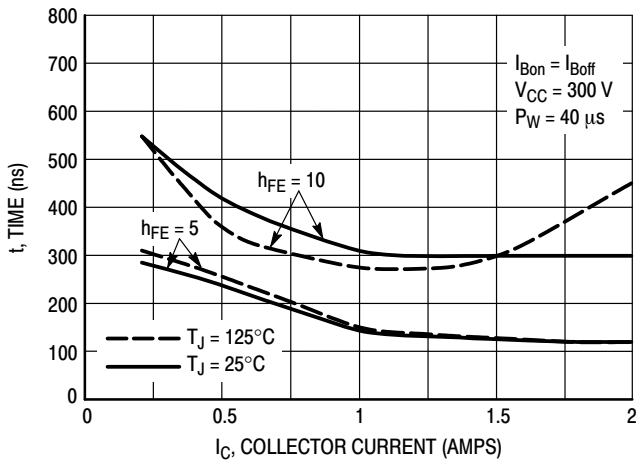

Figure 13. Resistive Switching,  $t_{on}$

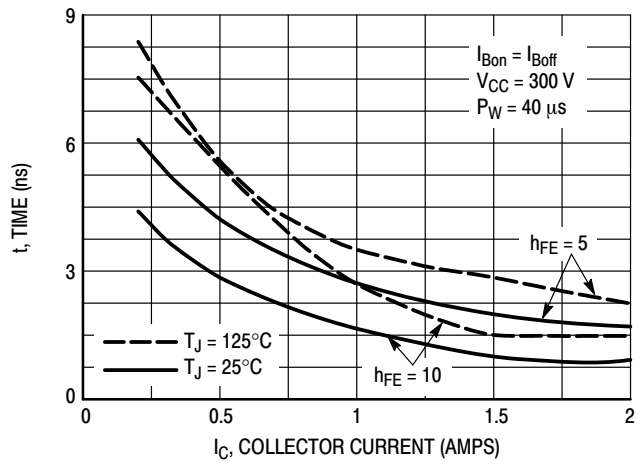

Figure 14. Resistive Switching,  $t_{off}$

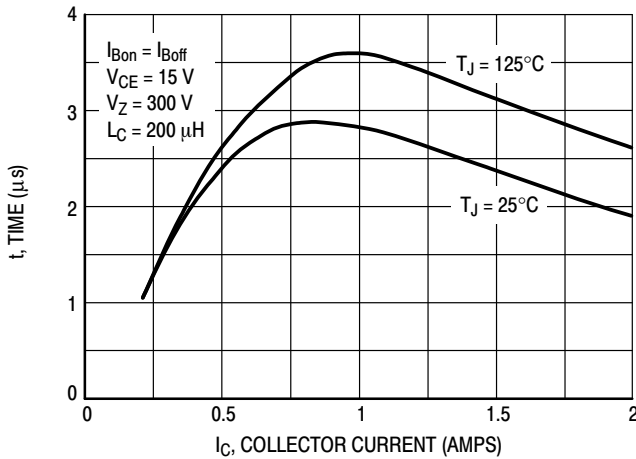

Figure 15. Inductive Storage Time,  $t_{si}$  @  $h_{FE} = 5$

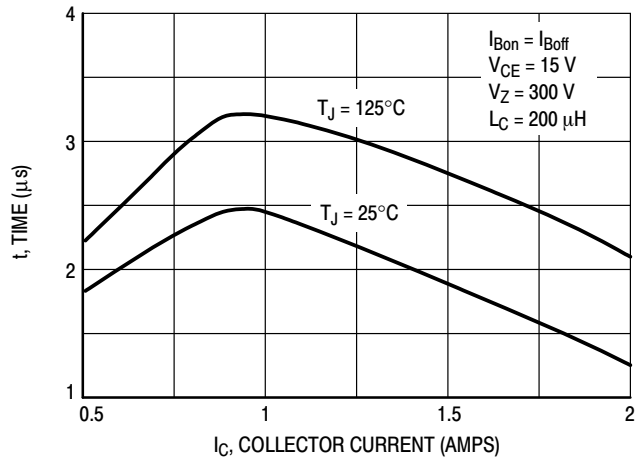

Figure 16. Inductive Storage Time,  $t_{si}$  @  $h_{FE} = 10$

TYPICAL SWITCHING CHARACTERISTICS

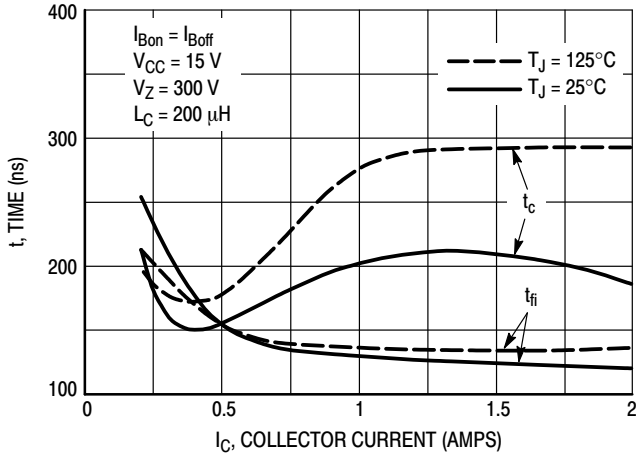

Figure 17. Inductive Fall and Cross Over Time,  $t_{fi}$  and  $t_c$  @  $h_{FE} = 5$

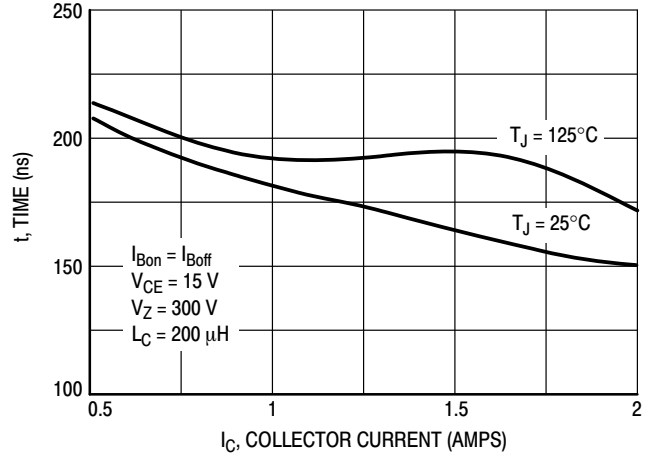

Figure 18. Inductive Fall Time,  $t_{fi}$  @  $h_{FE} = 10$

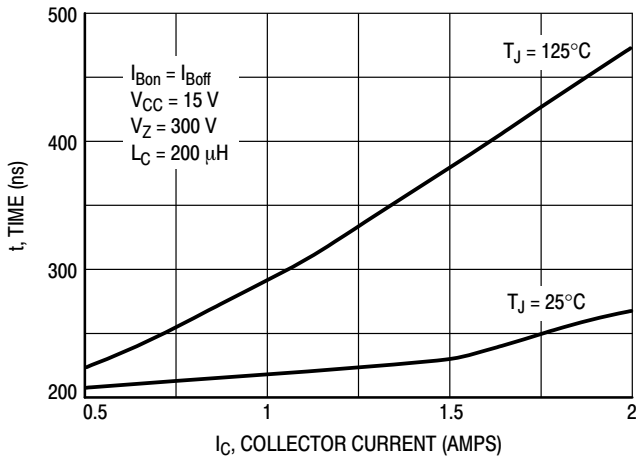

Figure 19. Inductive Cross Over Time,  $t_c$  @  $h_{FE} = 10$

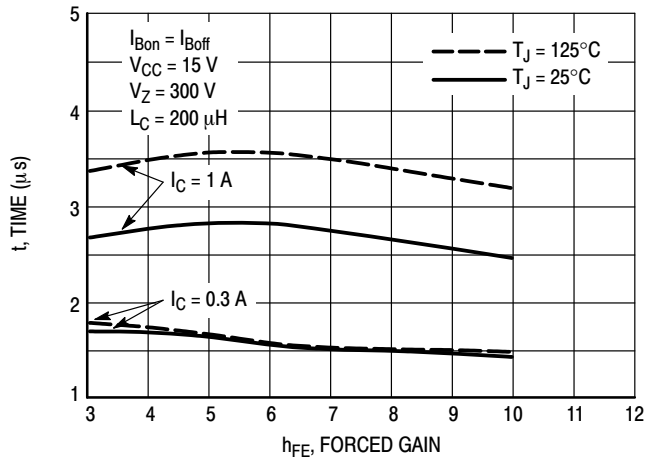

Figure 20. Inductive Storage Time,  $t_{si}$

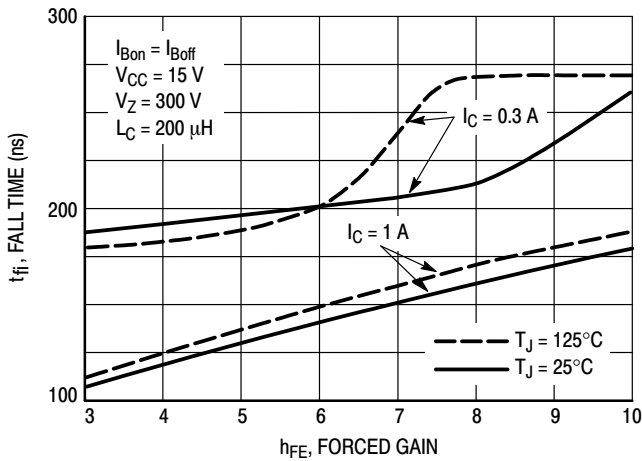

Figure 21. Inductive Fall Time,  $t_f$

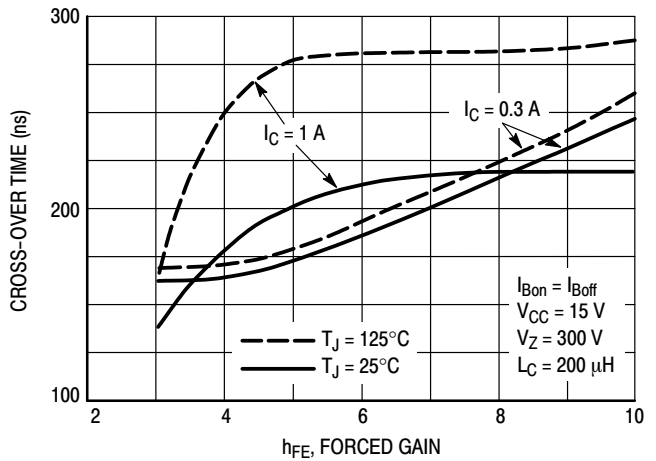

Figure 22. Inductive Cross Over Time,  $t_c$

# BUD42D

## TYPICAL SWITCHING CHARACTERISTICS

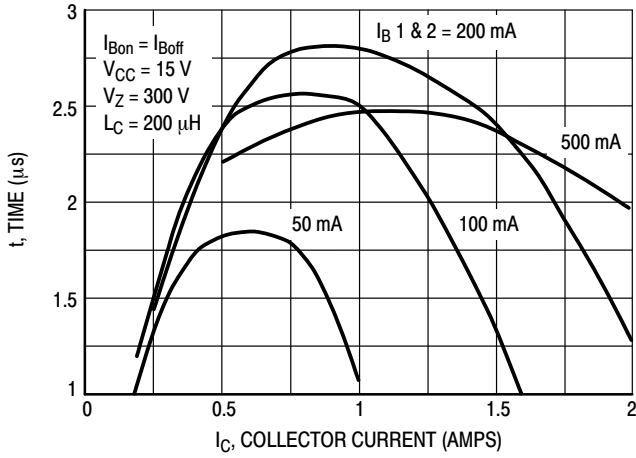

Figure 23. Inductive Storage Time,  $t_{si}$

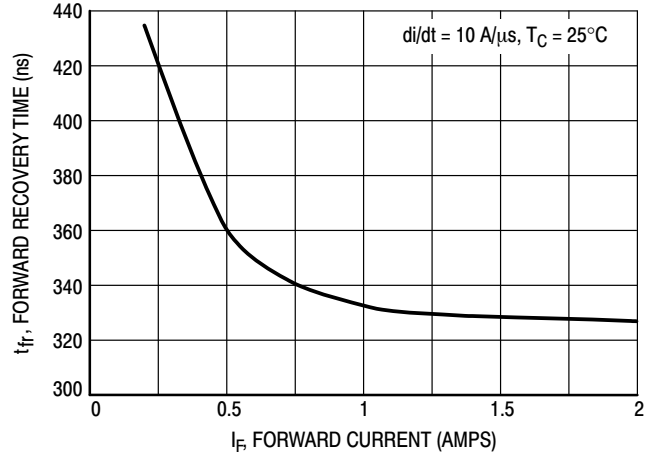

Figure 24. Forward Recovery Time,  $t_{fr}$

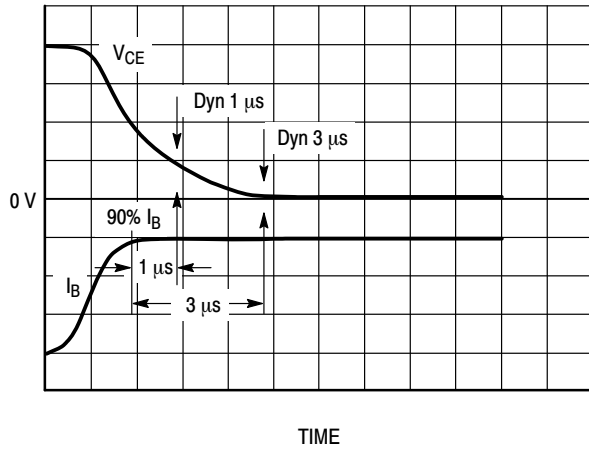

Figure 25. Dynamic Saturation Voltage Measurements

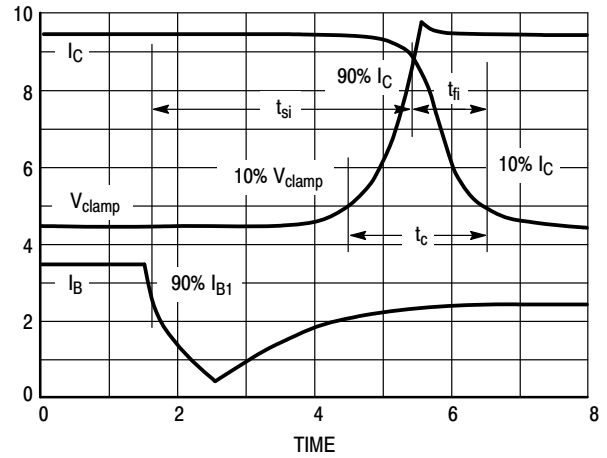
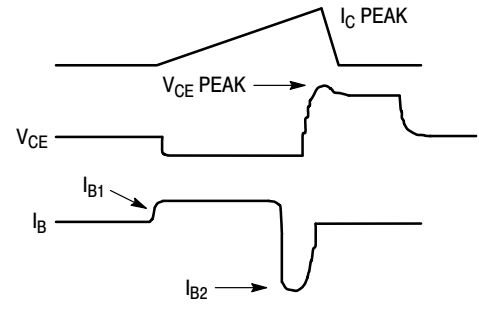
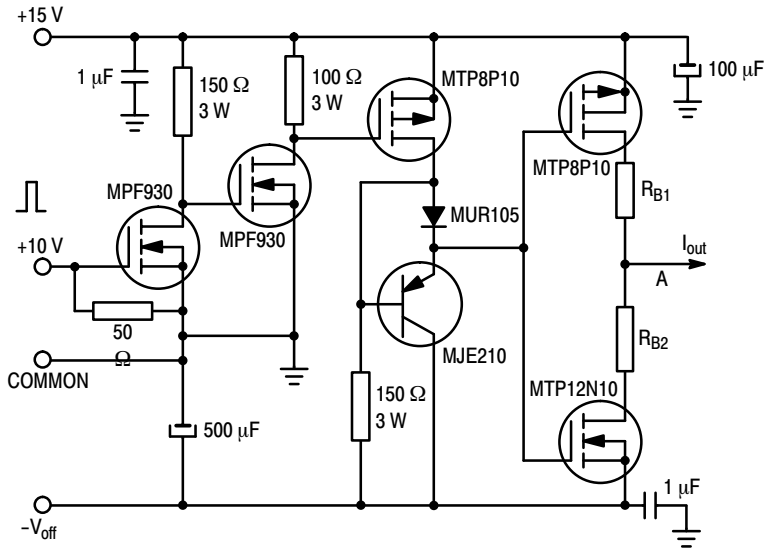

Figure 26. Inductive Switching Measurements

# BUD42D

## TYPICAL SWITCHING CHARACTERISTICS

Table 1. Inductive Load Switching Drive Circuit



$V_{(BR)CEO(sus)}$   
 $L = 10 \text{ mH}$   
 $R_{B2} = \infty$   
 $V_{CC} = 20 \text{ Volts}$   
 $I_{C(pk)} = 100 \text{ mA}$

**Inductive Switching**  
 $L = 200 \mu\text{H}$   
 $R_{B2} = 0$   
 $V_{CC} = 15 \text{ Volts}$   
 $R_{B1}$  selected for desired  $I_{B1}$

**RBSOA**  
 $L = 500 \mu\text{H}$   
 $R_{B2} = 0$   
 $V_{CC} = 15 \text{ Volts}$   
 $R_{B1}$  selected for desired  $I_{B1}$

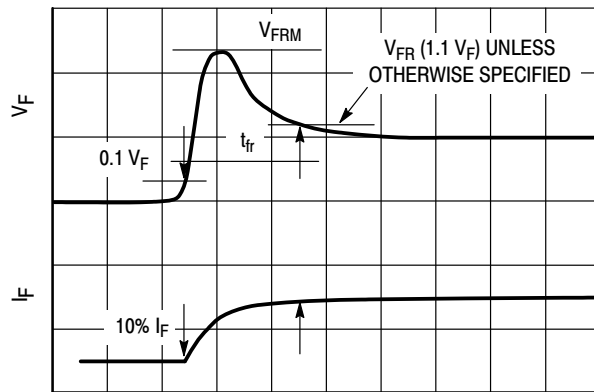

Figure 27.  $t_{fr}$  Measurement

# BUD42D

## MAXIMUM RATINGS

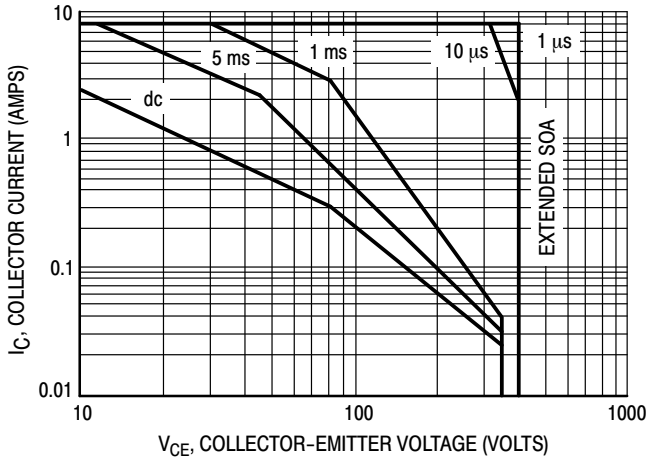

Figure 28. Forward Bias Safe Operating Area

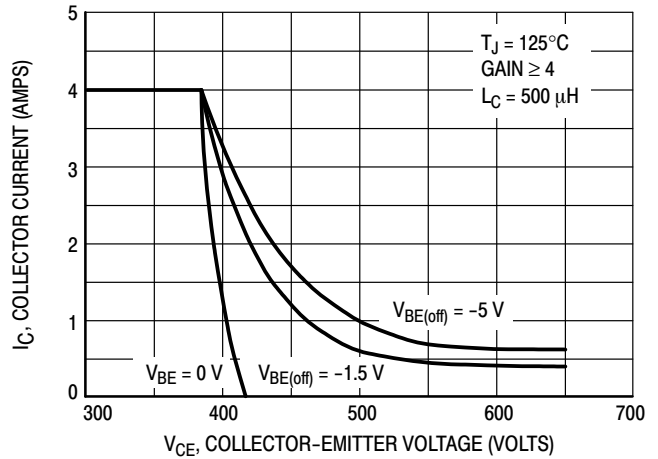

Figure 29. Reverse Bias Safe Operating Area

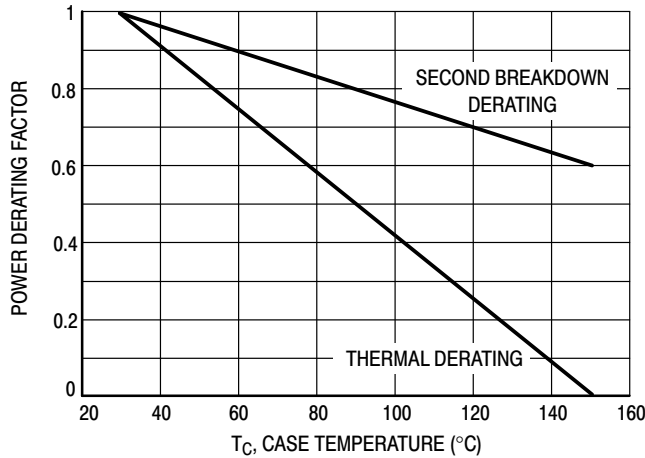

Figure 30. Power Derating

There are two limitations on the power handling ability of a transistor: average junction temperature and second breakdown. Safe operating area curves indicate  $I_C$ - $V_{CE}$  limits of the transistor that must be observed for reliable operation; i.e., the transistor must not be subjected to greater dissipation than the curves indicate. The data of Figure 28 is based on  $T_C = 25^\circ\text{C}$ ;  $T_{j(pk)}$  is variable depending on power level. Second breakdown pulse limits are valid for duty cycles to 10% but must be derated when  $T_C > 25^\circ\text{C}$ . Second Breakdown limitations do not derate like thermal limitations. Allowable current at the voltages shown on

Figure 28 may be found at any case temperature by using the appropriate curve on Figure 30.

$T_{j(pk)}$  may be calculated from the data in Figure 31. At any case temperatures, thermal limitations will reduce the power that can be handled to values less than the limitations imposed by second breakdown. For inductive loads, high voltage and current must be sustained simultaneously during turn-off with the base to emitter junction reverse biased. The safe level is specified as reverse biased safe operating area (Figure 29). This rating is verified under clamped conditions so that the device is never subjected to an avalanche mode.

# BUD42D

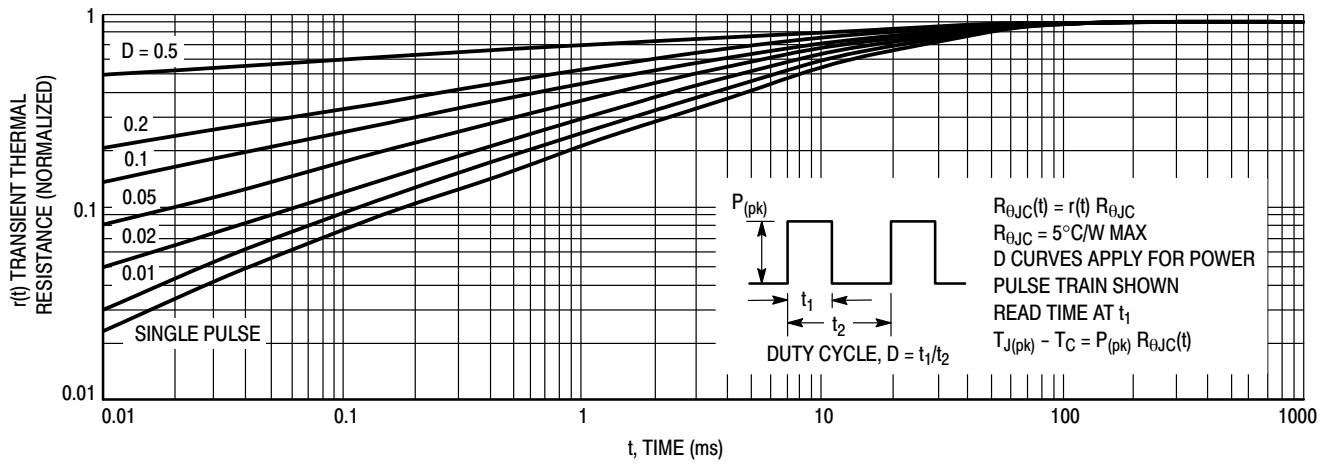

Figure 31. Thermal Response

## ORDERING INFORMATION

Device	Package	Shipping†
BUD42D-1G	DPAK Straight Lead (Pb-Free)	75 Units / Rail
BUD42DT4G	DPAK (Pb-Free)	2500 Units / Tape & Reel

†For information on tape and reel specifications, including part orientation and tape sizes, please refer to our Tape and Reel Packaging Specifications Brochure, BRD8011/D.

# BUD42D

## PACKAGE DIMENSIONS

### DPAK CASE 369C ISSUE D

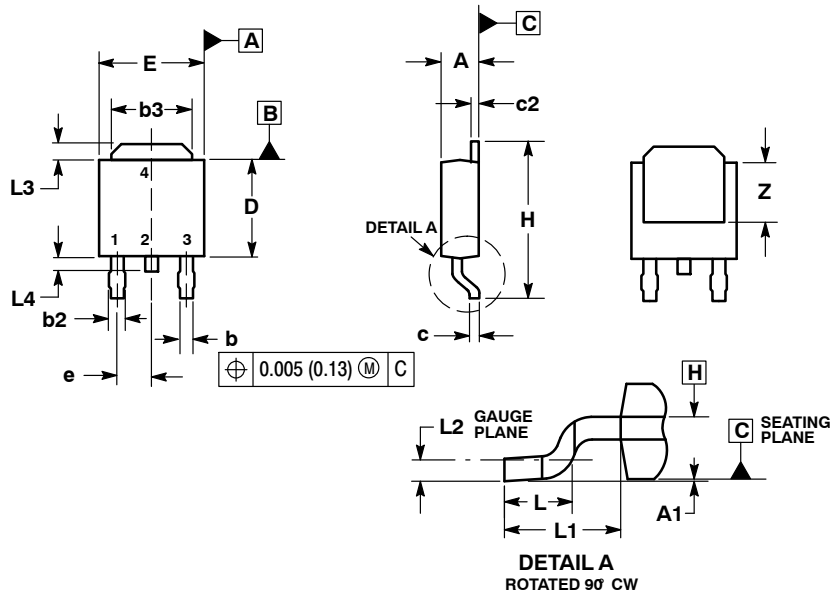

**NOTES:**

1. DIMENSIONING AND TOLERANCING PER ASME Y14.5M, 1994.
2. CONTROLLING DIMENSION: INCHES.
3. THERMAL PAD CONTOUR OPTIONAL WITHIN DIMENSIONS b3, L3 and Z.
4. DIMENSIONS D AND E DO NOT INCLUDE MOLD FLASH, PROTRUSIONS, OR BURRS. MOLD FLASH, PROTRUSIONS, OR GATE BURRS SHALL NOT EXCEED 0.006 INCHES PER SIDE.
5. DIMENSIONS D AND E ARE DETERMINED AT THE OUTERMOST EXTREMES OF THE PLASTIC BODY.
6. DATUMS A AND B ARE DETERMINED AT DATUM PLANE H.

DIM	INCHES		MILLIMETERS	
	MIN	MAX	MIN	MAX
A	0.086	0.094	2.18	2.38
A1	0.000	0.005	0.00	0.13
b	0.025	0.035	0.63	0.89
b2	0.030	0.045	0.76	1.14
b3	0.180	0.215	4.57	5.46
c	0.018	0.024	0.46	0.61
c2	0.018	0.024	0.46	0.61
D	0.235	0.245	5.97	6.22
E	0.250	0.265	6.35	6.73
e	0.090 BSC		2.29 BSC	
H	0.370	0.410	9.40	10.41
L	0.055	0.070	1.40	1.78
L1	0.108 REF		2.74 REF	
L2	0.020 BSC		0.51 BSC	
L3	0.035	0.050	0.89	1.27
L4	---	0.040	---	1.01
Z	0.155	---	3.93	---

### SOLDERING FOOTPRINT\*

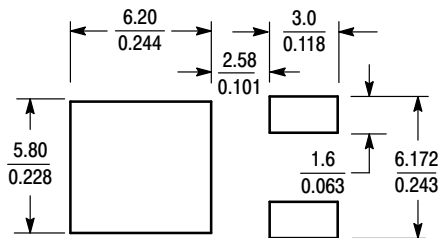

SCALE 3:1  $\left(\frac{\text{mm}}{\text{inches}}\right)$

**STYLE 1:**

1. BASE
2. COLLECTOR
3. EMITTER
4. COLLECTOR

\*For additional information on our Pb-Free strategy and soldering details, please download the ON Semiconductor Soldering and Mounting Techniques Reference Manual, SOLDERRM/D.

# BUD42D

## PACKAGE DIMENSIONS

### IPAK CASE 369D ISSUE C

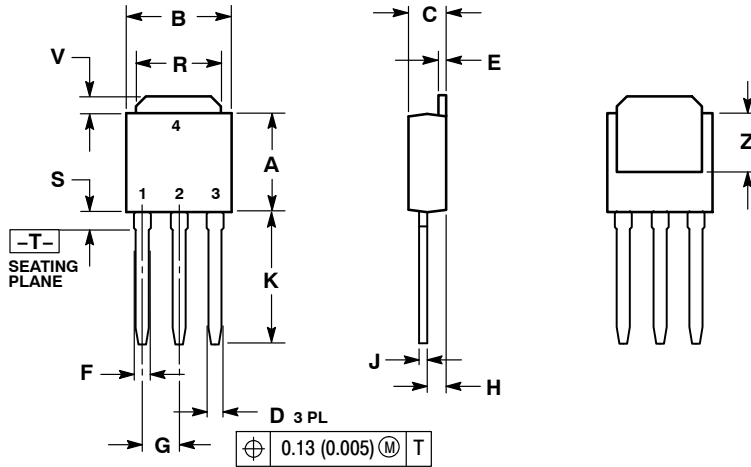

- NOTES:
1. DIMENSIONING AND TOLERANCING PER ANSI Y14.5M, 1982.
  2. CONTROLLING DIMENSION: INCH.

DIM	INCHES		MILLIMETERS	
	MIN	MAX	MIN	MAX
A	0.235	0.245	5.97	6.35
B	0.250	0.265	6.35	6.73
C	0.086	0.094	2.19	2.38
D	0.027	0.035	0.69	0.88
E	0.018	0.023	0.46	0.58
F	0.037	0.045	0.94	1.14
G	0.090	BSC	2.29	BSC
H	0.034	0.040	0.87	1.01
J	0.018	0.023	0.46	0.58
K	0.350	0.380	8.89	9.65
R	0.180	0.215	4.45	5.45
S	0.025	0.040	0.63	1.01
V	0.035	0.050	0.89	1.27
Z	0.155	---	3.93	---

STYLE 1:

- PIN 1: BASE  
 2. COLLECTOR  
 3. EMITTER  
 4. COLLECTOR

ON Semiconductor and are registered trademarks of Semiconductor Components Industries, LLC (SCILLC). SCILLC owns the rights to a number of patents, trademarks, copyrights, trade secrets, and other intellectual property. A listing of SCILLC's product/patent coverage may be accessed at [www.onsemi.com/site/pdf/Patent-Marking.pdf](http://www.onsemi.com/site/pdf/Patent-Marking.pdf). SCILLC reserves the right to make changes without further notice to any products herein. SCILLC makes no warranty, representation or guarantee regarding the suitability of its products for any particular purpose, nor does SCILLC assume any liability arising out of the application or use of any product or circuit, and specifically disclaims any and all liability, including without limitation special, consequential or incidental damages. "Typical" parameters which may be provided in SCILLC data sheets and/or specifications can and do vary in different applications and actual performance may vary over time. All operating parameters, including "Typicals" must be validated for each customer application by customer's technical experts. SCILLC does not convey any license under its patent rights nor the rights of others. SCILLC products are not designed, intended, or authorized for use as components in systems intended for surgical implant into the body, or other applications intended to support or sustain life, or for any other application in which the failure of the SCILLC product could create a situation where personal injury or death may occur. Should Buyer purchase or use SCILLC products for any such unintended or unauthorized application, Buyer shall indemnify and hold SCILLC and its officers, employees, subsidiaries, affiliates, and distributors harmless against all claims, costs, damages, and expenses, and reasonable attorney fees arising out of, directly or indirectly, any claim of personal injury or death associated with such unintended or unauthorized use, even if such claim alleges that SCILLC was negligent regarding the design or manufacture of the part. SCILLC is an Equal Opportunity/Affirmative Action Employer. This literature is subject to all applicable copyright laws and is not for resale in any manner.

### PUBLICATION ORDERING INFORMATION

**LITERATURE FULFILLMENT:**

Literature Distribution Center for ON Semiconductor  
 P.O. Box 5163, Denver, Colorado 80217 USA  
**Phone:** 303-675-2175 or 800-344-3860 Toll Free USA/Canada  
**Fax:** 303-675-2176 or 800-344-3867 Toll Free USA/Canada  
**Email:** [orderlit@onsemi.com](mailto:orderlit@onsemi.com)

**N. American Technical Support:** 800-282-9855 Toll Free  
 USA/Canada  
**Europe, Middle East and Africa Technical Support:**  
 Phone: 421 33 790 2910  
**Japan Customer Focus Center**  
 Phone: 81-3-5817-1050

**ON Semiconductor Website:** [www.onsemi.com](http://www.onsemi.com)

**Order Literature:** <http://www.onsemi.com/orderlit>

For additional information, please contact your local Sales Representative

## Looking for pricing, stock, or lifecycle information?

Click below to explore more details on WIN SOURCE:

 [View BUD42DT4G on WIN SOURCE](#)

 [ON Semiconductor](#) Information

## Optimize Your Supply Chain with WIN SOURCE Solutions

-  Global Sourcing Solution
-  Obsolete Management
-  Cost Control Management
-  Shortage Management
-  Alternative Solution
-  Excess Inventory Management