



**THE DATASHEET OF
2SD1785**



Darlington

2SD1785

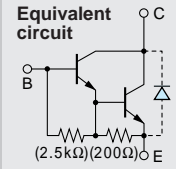

Silicon NPN Triple Diffused Planar Transistor (Complement to type 2SB1258)

Application : Driver for Solenoid, Relay and Motor, Series Regulator, and General Purpose

Absolute maximum ratings (Ta=25°C)

Symbol	Ratings	Unit
V _{CB0}	120	V
V _{CEO}	120	V
V _{EB0}	6	V
I _C	6(Pulse10)	A
I _B	1	A
P _C	30(T _C =25°C)	W
T _J	150	°C
T _{stg}	-55 to +150	°C

Electrical Characteristics (Ta=25°C)

Symbol	Conditions	Ratings	Unit
I _{CB0}	V _{CB} =120V	10max	μA
I _{EB0}	V _{EB} =6V	10max	mA
V _{(BR)CEO}	I _C =10mA	120min	V
h _{FE}	V _{CE} =2V, I _C =3A	2000min	
V _{CE(sat)}	I _C =2A, I _B =3mA	1.5max	V
f _T	V _{CE} =12V, I _E =-0.1A	100typ	MHz
C _{OB}	V _{CB} =10V, f=1MHz	70typ	pF

External Dimensions FM20(TO220F)

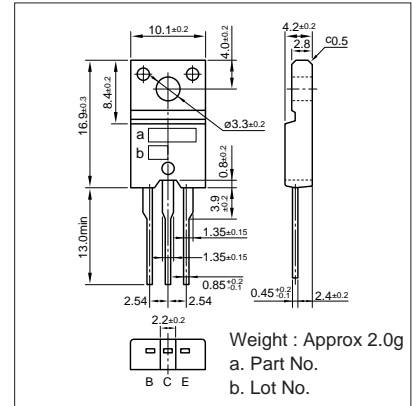

Typical Switching Characteristics (Common Emitter)

V _{CC} (V)	R _L (Ω)	I _C (A)	V _{BB1} (V)	V _{BB2} (V)	I _{B1} (mA)	I _{B2} (mA)	t _{on} (μs)	t _{stg} (μs)	t _f (μs)
30	10	3	10	-1.5	3	-3	0.5typ	5.5typ	1.5typ

I_C-V_{CE} Characteristics (Typical)

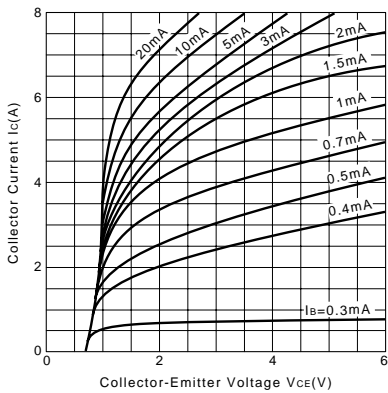

V_{CE(sat)}-I_B Characteristics (Typical)

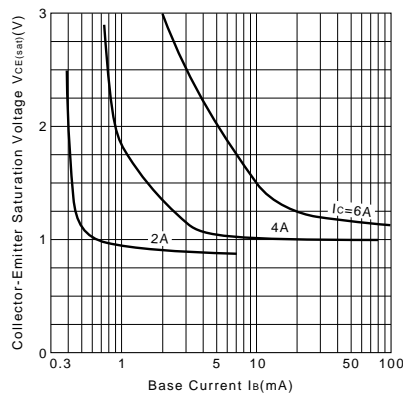

I_C-V_{BE} Temperature Characteristics (Typical)

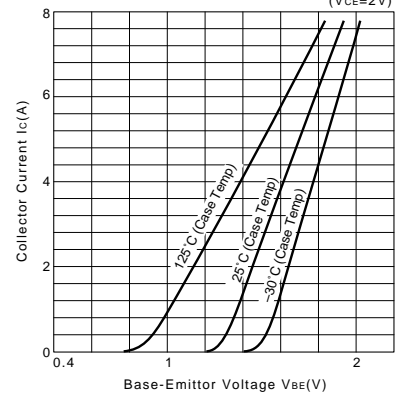

h_{FE}-I_C Characteristics (Typical)

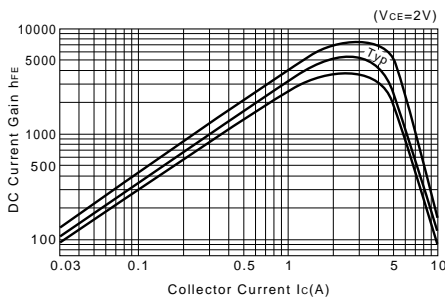

h_{FE}-I_C Temperature Characteristics (Typical)

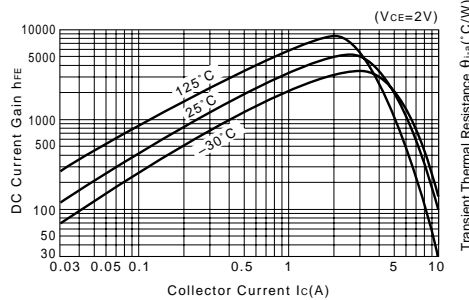

θ_{j-a}-t Characteristics

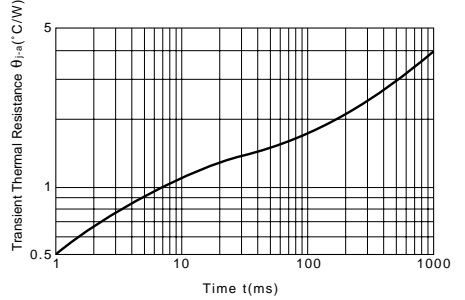

f_T-I_E Characteristics (Typical)

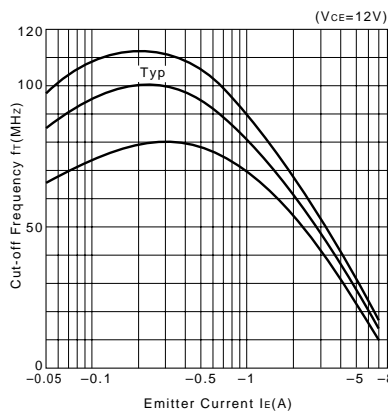

Safe Operating Area (Single Pulse)

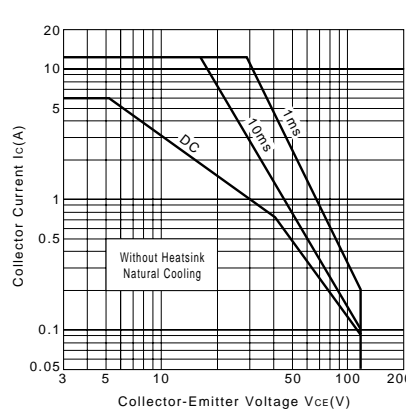

P_C-T_a Derating

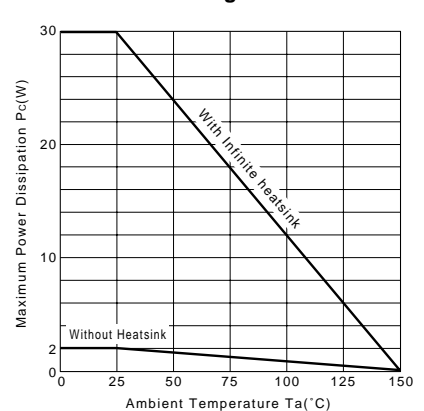

Looking for pricing, stock, or lifecycle information?

Click below to explore more details on WIN SOURCE:

- [View 2SD1785 on WIN SOURCE](#)
- [Sanken Information](#)

Optimize Your Supply Chain with WIN SOURCE Solutions

- ✓ Global Sourcing Solution
- ✓ Obsolete Management
- ✓ Cost Control Management
- ✓ Shortage Management
- ✓ Alternative Solution
- ✓ Excess Inventory Management