

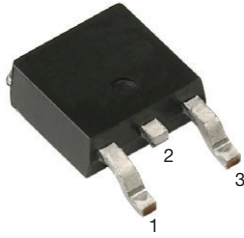

**THE DATASHEET OF
VS-8EWF04STRR-M3**



Surface Mount Fast Soft Recovery Rectifier Diode, 8 A



TO-252AA (D-PAK)

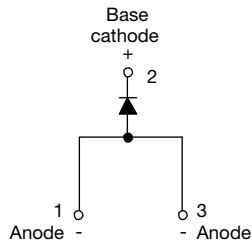

FEATURES

- Glass passivated pellet chip junction
- Meets MSL level 1, per J-STD-020, LF maximum peak of 260 °C
- Material categorization: for definitions of compliance please see www.vishay.com/doc?99912



RoHS
COMPLIANT
HALOGEN
FREE

APPLICATIONS

- Output rectification and freewheeling diode in inverters, choppers and converters
- Input rectifications where severe restrictions on conducted EMI should be met

DESCRIPTION

The VS-8EWF..S-M3 fast soft recovery rectifier series has been optimized for combined short reverse recovery time, low forward voltage drop and low leakage current.

The glass passivation ensures stable reliable operation in the most severe temperature and power cycling conditions.

PRODUCT SUMMARY	
Package	TO-252AA (D-PAK)
$I_{F(AV)}$	8 A
V_R	200 V, 400 V, 600 V
V_F at I_F	1.2 V
I_{FSM}	150 A
t_{rr}	55 ns
T_J max.	150 °C
Diode variation	Single die
Snap factor	0.5

MAJOR RATINGS AND CHARACTERISTICS			
SYMBOL	CHARACTERISTICS	VALUES	UNITS
$I_{F(AV)}$	Sinusoidal waveform	8	A
V_{RRM}		200 to 600	V
I_{FSM}		150	A
V_F	8 A, $T_J = 25$ °C	1.2	V
t_{rr}	1 A, 100 A/ μ s	55	ns
T_J	Range	-40 to +150	°C

VOLTAGE RATINGS			
PART NUMBER	V_{RRM} , MAXIMUM PEAK REVERSE VOLTAGE V	V_{RSM} , MAXIMUM NON-REPETITIVE PEAK REVERSE VOLTAGE V	I_{RRM} AT 150 °C mA
VS-8EWF02S-M3	200	300	3
VS-8EWF04S-M3	400	500	
VS-8EWF06S-M3	600	700	

ABSOLUTE MAXIMUM RATINGS				
PARAMETER	SYMBOL	TEST CONDITIONS	VALUES	UNITS
Maximum average forward current	$I_{F(AV)}$	$T_C = 96$ °C, 180° conduction half sine wave	8	A
Maximum peak one cycle non-repetitive surge current	I_{FSM}	10 ms sine pulse, rated V_{RRM} applied	125	
		10 ms sine pulse, no voltage reapplied	150	
Maximum I^2t for fusing	I^2t	10 ms sine pulse, rated V_{RRM} applied	78	A ² s
		10 ms sine pulse, no voltage reapplied	110	
Maximum $I^2\sqrt{t}$ for fusing	$I^2\sqrt{t}$	$t = 0.1$ ms to 10 ms, no voltage reapplied	1100	A ² \sqrt{s}



ELECTRICAL SPECIFICATIONS					
PARAMETER	SYMBOL	TEST CONDITIONS		VALUES	UNITS
Maximum forward voltage drop	V_{FM}	8 A, $T_J = 25\text{ }^\circ\text{C}$		1.2	V
Forward slope resistance	r_t	$T_J = 150\text{ }^\circ\text{C}$		16	$\text{m}\Omega$
Threshold voltage	$V_{F(TO)}$			1.13	V
Maximum reverse leakage current	I_{RM}	$T_J = 25\text{ }^\circ\text{C}$	$V_R = \text{Rated } V_{RRM}$	0.1	mA
		$T_J = 150\text{ }^\circ\text{C}$		3	

RECOVERY CHARACTERISTICS				
PARAMETER	SYMBOL	TEST CONDITIONS	VALUES	UNITS
Reverse recovery time	t_{rr}	I_F at 1 A _{pk} 100 A/ μs $T_J = 25\text{ }^\circ\text{C}$	55	ns
		I_F at 8 A _{pk} 25 A/ μs $T_J = 25\text{ }^\circ\text{C}$	200	
Reverse recovery current	I_{rr}	$T_J = 25\text{ }^\circ\text{C}$	2.6	A
Reverse recovery charge	Q_{rr}	$T_J = 25\text{ }^\circ\text{C}$	0.25	μC
Snap factor	S		0.5	

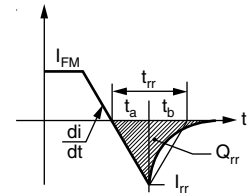

THERMAL - MECHANICAL SPECIFICATIONS				
PARAMETER	SYMBOL	TEST CONDITIONS	VALUES	UNITS
Maximum junction and storage temperature range	T_J, T_{Stg}		-40 to +150	$^\circ\text{C}$
Maximum thermal resistance, junction to case	R_{thJC}	DC operation	2.5	$^\circ\text{C}/\text{W}$
Typical thermal resistance, junction to ambient (PCB mount)	$R_{thJA}^{(1)}$		50	
Approximate weight			1	g
			0.03	oz.
Marking device		Case style TO-252AA (D-PAK)	8EWF02S	
			8EWF04S	
			8EWF06S	

Note

⁽¹⁾ When mounted on 1" square (650 mm²) PCB of FR-4 or G-10 material 4 oz. (140 μm) copper 40 $^\circ\text{C}/\text{W}$
For recommended footprint and soldering techniques refer to application note #AN-994

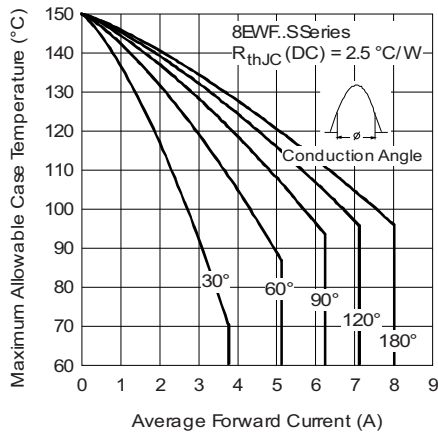

Fig. 1 - Current Rating Characteristics

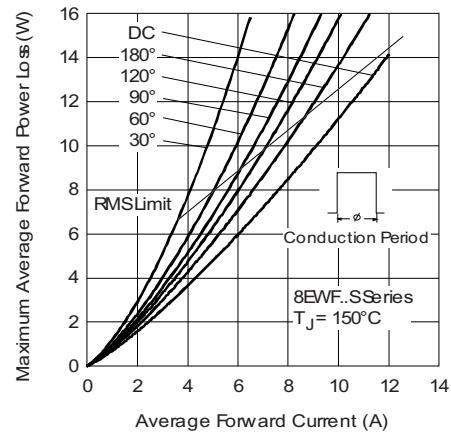

Fig. 4 - Forward Power Loss Characteristics

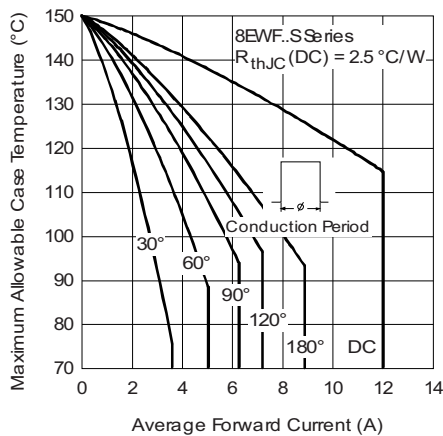

Fig. 2 - Current Rating Characteristics

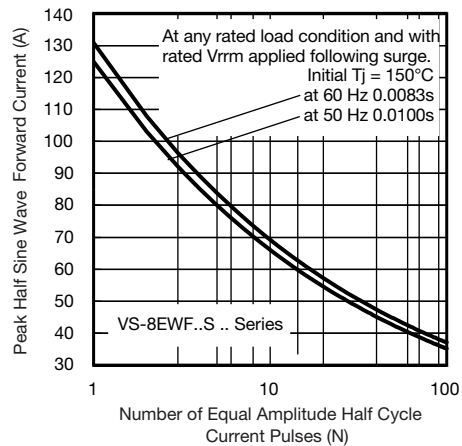

Fig. 5 - Maximum Non-Repetitive Surge Current

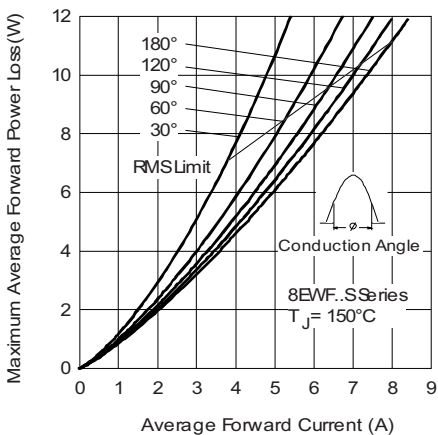

Fig. 3 - Forward Power Loss Characteristics

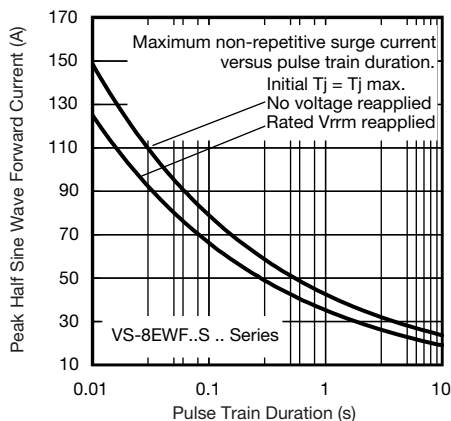

Fig. 6 - Maximum Non-Repetitive Surge Current

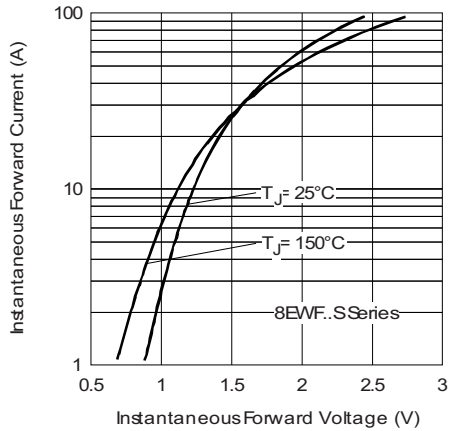

Fig. 7 - Forward Voltage Drop Characteristics

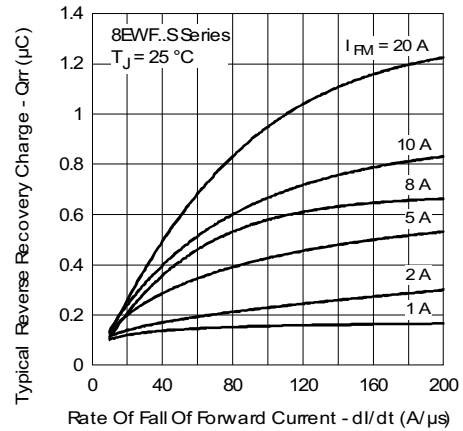

Fig. 10 - Recovery Charge Characteristics, $T_J = 25\text{ }^\circ\text{C}$

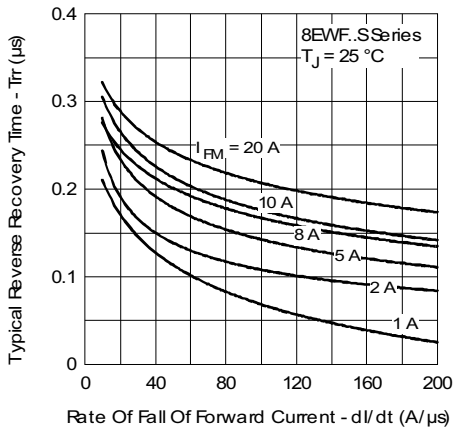

Fig. 8 - Recovery Time Characteristics, $T_J = 25\text{ }^\circ\text{C}$

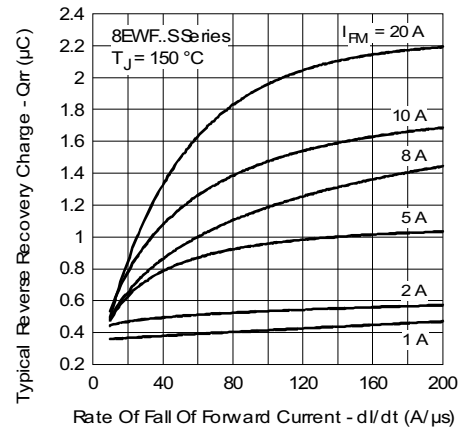

Fig. 11 - Recovery Charge Characteristics, $T_J = 150\text{ }^\circ\text{C}$

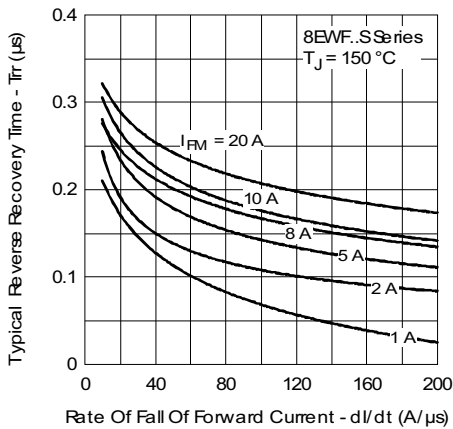

Fig. 9 - Recovery Time Characteristics, $T_J = 150\text{ }^\circ\text{C}$

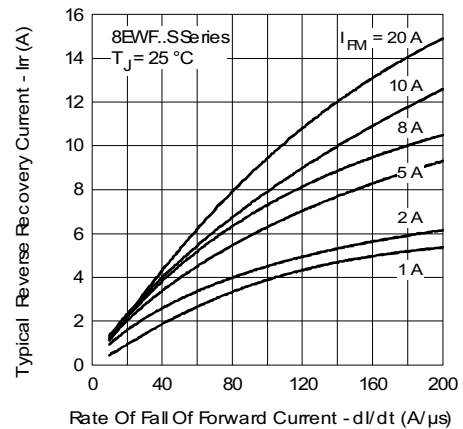

Fig. 12 - Recovery Current Characteristics, $T_J = 25\text{ }^\circ\text{C}$

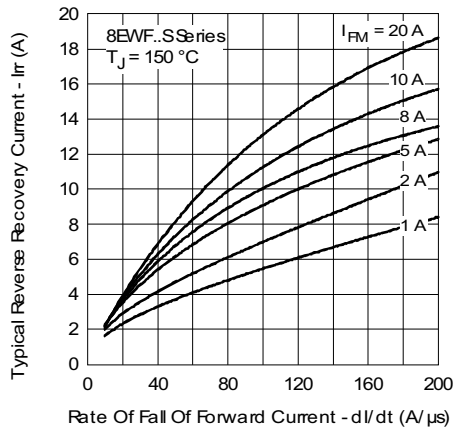

Fig. 13 - Recovery Current Characteristics, $T_J = 150\text{ }^\circ\text{C}$

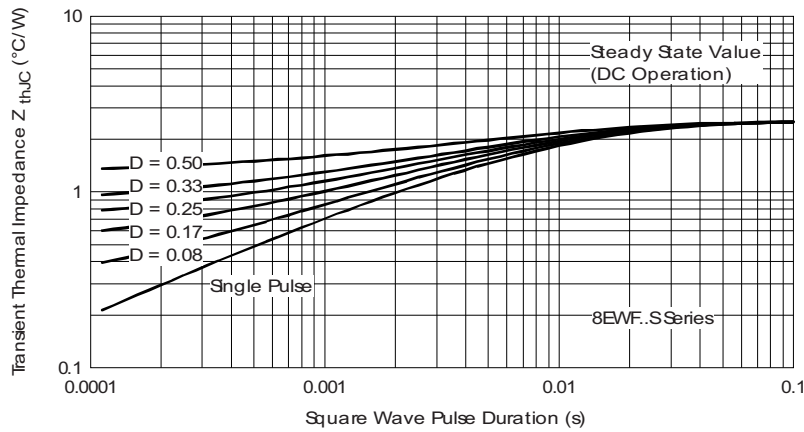
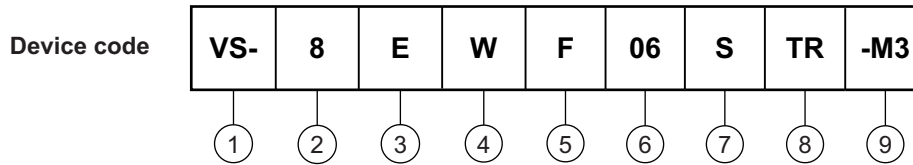

Fig. 14 - Thermal Impedance Z_{thJC} Characteristics



ORDERING INFORMATION TABLE



- 1** - Vishay Semiconductors product
- 2** - Current rating (8 = 8 A)
- 3** - Circuit configuration:
E = single diode
- 4** - Package:
W = D-PAK
- 5** - Type of silicon:
F = fast soft recovery rectifier
- 6** - Voltage code x 100 = V_{RRM}

02 = 200 V
04 = 400 V
06 = 600 V
- 7** - S = surface mountable
- 8** -
 - TR = tape and reel
 - TRR = tape and reel (right oriented)
 - TRL = tape and reel (left oriented)
- 9** - Environmental digit:
-M3 = halogen-free, RoHS-compliant, and terminations lead (Pb)-free

ORDERING INFORMATION (Example)			
PREFERRED P/N	QUANTITY PER T/R	MINIMUM ORDER QUANTITY	PACKAGING DESCRIPTION
VS-8EWF02S-M3	75	3000	Antistatic plastic tubes
VS-8EWF02STR-M3	2000	2000	13" diameter reel
VS-8EWF02STRL-M3	3000	3000	13" diameter reel
VS-8EWF02STRR-M3	3000	3000	13" diameter reel
VS-8EWF04S-M3	75	3000	Antistatic plastic tubes
VS-8EWF04STR-M3	2000	2000	13" diameter reel
VS-8EWF04STRL-M3	3000	3000	13" diameter reel
VS-8EWF04STRR-M3	3000	3000	13" diameter reel
VS-8EWF06S-M3	75	3000	Antistatic plastic tubes
VS-8EWF06STR-M3	2000	2000	13" diameter reel
VS-8EWF06STRL-M3	3000	3000	13" diameter reel
VS-8EWF06STRR-M3	3000	3000	13" diameter reel

LINKS TO RELATED DOCUMENTS	
Dimensions	www.vishay.com/doc?95627
Part marking information	www.vishay.com/doc?95176
Packaging information	www.vishay.com/doc?95033
SPIICE model	www.vishay.com/doc?95551



D-PAK (TO-252AA) "M"

DIMENSIONS in millimeters and inches

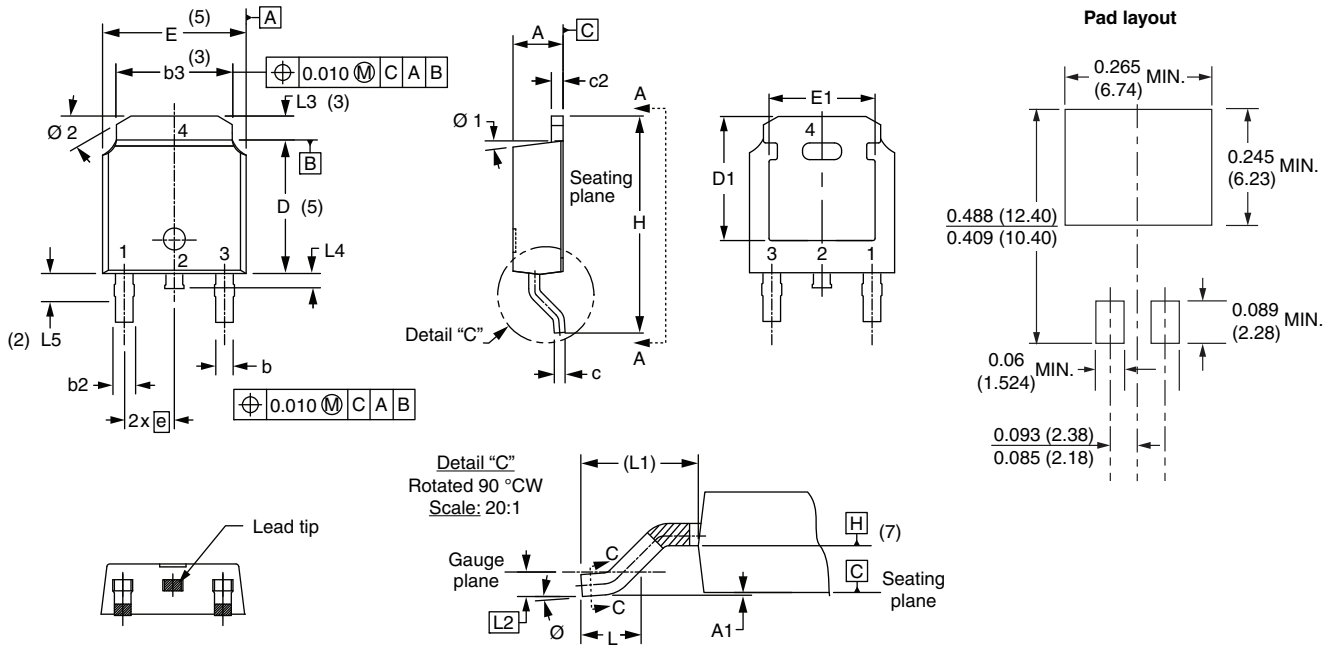

SYMBOL	MILLIMETERS		INCHES		NOTES	SYMBOL	MILLIMETERS		INCHES		NOTES
	MIN.	MAX.	MIN.	MAX.			MIN.	MAX.	MIN.	MAX.	
A	2.18	2.39	0.086	0.094		e	2.29 BSC		0.090 BSC		
A1	-	0.13	-	0.005		H	9.40	10.41	0.370	0.410	
b	0.64	0.89	0.025	0.035		L	1.40	1.78	0.055	0.070	
b2	0.76	1.14	0.030	0.045		L1	2.74 BSC		0.108 REF.		
b3	4.95	5.46	0.195	0.215	3	L2	0.51 BSC		0.020 BSC		
c	0.46	0.61	0.018	0.024		L3	0.89	1.27	0.035	0.050	3
c2	0.46	0.89	0.018	0.035		L4	-	1.02	-	0.040	
D	5.97	6.22	0.235	0.245	5	L5	1.14	1.52	0.045	0.060	2
D1	5.21	-	0.205	-	3	Ø	0°	10°	0°	10°	
E	6.35	6.73	0.250	0.265	5	Ø1	0°	15°	0°	15°	
E1	4.32	-	0.170	-	3	Ø2	25°	35°	25°	35°	

Notes

- (1) Dimensioning and tolerancing as per ASME Y14.5M-1994
- (2) Lead dimension uncontrolled in L5
- (3) Dimension D1, E1, L3 and b3 establish a minimum mounting surface for thermal pad
- (4) Section C - C dimension apply to the flat section of the lead between 0.13 and 0.25 mm (0.005 and 0.10") from the lead tip
- (5) Dimension D, and E do not include mold flash. Mold flash shall not exceed 0.127 mm (0.005") per side. These dimensions are measured at the outermost extremes of the plastic body
- (6) Dimension b1 and c1 applied to base metal only
- (7) Datum A and B to be determined at datum plane H
- (8) Outline conforms to JEDEC® outline TO-252AA



Disclaimer

ALL PRODUCT, PRODUCT SPECIFICATIONS AND DATA ARE SUBJECT TO CHANGE WITHOUT NOTICE TO IMPROVE RELIABILITY, FUNCTION OR DESIGN OR OTHERWISE.

Vishay Intertechnology, Inc., its affiliates, agents, and employees, and all persons acting on its or their behalf (collectively, "Vishay"), disclaim any and all liability for any errors, inaccuracies or incompleteness contained in any datasheet or in any other disclosure relating to any product.

Vishay makes no warranty, representation or guarantee regarding the suitability of the products for any particular purpose or the continuing production of any product. To the maximum extent permitted by applicable law, Vishay disclaims (i) any and all liability arising out of the application or use of any product, (ii) any and all liability, including without limitation special, consequential or incidental damages, and (iii) any and all implied warranties, including warranties of fitness for particular purpose, non-infringement and merchantability.

Statements regarding the suitability of products for certain types of applications are based on Vishay's knowledge of typical requirements that are often placed on Vishay products in generic applications. Such statements are not binding statements about the suitability of products for a particular application. It is the customer's responsibility to validate that a particular product with the properties described in the product specification is suitable for use in a particular application. Parameters provided in datasheets and / or specifications may vary in different applications and performance may vary over time. All operating parameters, including typical parameters, must be validated for each customer application by the customer's technical experts. Product specifications do not expand or otherwise modify Vishay's terms and conditions of purchase, including but not limited to the warranty expressed therein.

Except as expressly indicated in writing, Vishay products are not designed for use in medical, life-saving, or life-sustaining applications or for any other application in which the failure of the Vishay product could result in personal injury or death. Customers using or selling Vishay products not expressly indicated for use in such applications do so at their own risk. Please contact authorized Vishay personnel to obtain written terms and conditions regarding products designed for such applications.

No license, express or implied, by estoppel or otherwise, to any intellectual property rights is granted by this document or by any conduct of Vishay. Product names and markings noted herein may be trademarks of their respective owners.

Looking for pricing, stock, or lifecycle information?

Click below to explore more details on WIN SOURCE:

 [View VS-8EWF04STRR-M3 on WIN SOURCE](#)

 [Vishay Information](#)

Optimize Your Supply Chain with WIN SOURCE Solutions

-  Global Sourcing Solution
-  Obsolete Management
-  Cost Control Management
-  Shortage Management
-  Alternative Solution
-  Excess Inventory Management