



**THE DATASHEET OF
BZG03C27TR3**



Zener Diodes

Features

- Glass passivated junction
- High reliability
- Voltage range 10 V to 270 V
- Fits onto 5 mm SMD footpads
- Wave and reflow solderable
- Lead (Pb)-free component
- Component in accordance to RoHS 2002/95/EC and WEEE 2002/96/EC



Applications

Voltage stabilization

Mechanical Data

Case: DO-214AC

Weight: approx. 77 mg

Packaging Codes/Options:

TR / 1.5 k 7 " reel

TR3 / 6 k 13 " reel 6 k/box

Absolute Maximum Ratings

$T_{amb} = 25\text{ }^{\circ}\text{C}$, unless otherwise specified

Parameter	Test condition	Symbol	Value	Unit
Power dissipation	$R_{thJA} < 25\text{ K/W}$, $T_{amb} = 100\text{ }^{\circ}\text{C}$	P_{diss}	3	W
	$R_{thJA} < 100\text{ K/W}$, $T_{amb} = 50\text{ }^{\circ}\text{C}$	P_{diss}	1.25	W
Non repetitive peak surge power dissipation	$t_p = 100\text{ }\mu\text{s}$ sq.pulse, $T_j = 25\text{ }^{\circ}\text{C}$ prior to surge	P_{ZSM}	600	W
Junction temperature		T_j	150	$^{\circ}\text{C}$
Storage temperature range		T_{stg}	- 65 to + 150	$^{\circ}\text{C}$

Thermal Characteristics

$T_{amb} = 25\text{ }^{\circ}\text{C}$, unless otherwise specified

Parameter	Test condition	Symbol	Value	Unit
Junction lead		R_{thJL}	25	K/W
Junction ambient	mounted on epoxy-glass hard tissue, Fig. 1a	R_{thJA}	150	K/W
	mounted on epoxy-glass hard tissue, Fig. 1b	R_{thJA}	125	K/W
	mounted on Al-oxid-ceramic (Al_2O_3), Fig. 1b	R_{thJA}	100	K/W

Electrical Characteristics

$T_{amb} = 25\text{ }^{\circ}\text{C}$, unless otherwise specified

Parameter	Test condition	Symbol	Min	Typ.	Max	Unit
Forward voltage	$I_F = 0.5\text{ A}$	V_F			1.2	V

BZG03C-Series



Vishay Semiconductors

Electrical Characteristics

BZG03C...

Partnumber	Zener Voltage Range			Dynamic Resistance		Test Current	Temperature Coefficient of Zener Voltage		Reverse Leakage Current		
	$V_Z @ I_{ZT}$			r_{zj} and $TK_{VZ} @ I_{ZT}$			I_{ZT}	$TK_{VZ} @ I_{ZT}$		$I_R @ V_R$	
	V			Ω			mA	%K		μA	V
	min	typ	max	typ	max			min	max	max	
BZG03C10	9.4	10	10.6	2	4	50	0.05	0.09	10	7.5	
BZG03C11	10.4	11	11.6	4	7	50	0.05	0.1	4	8.2	
BZG03C12	11.4	12	12.7	4	7	50	0.05	0.1	3	9.1	
BZG03C13	12.4	13	14.1	5	10	50	0.05	0.1	2	10	
BZG03C15	13.8	15	15.6	5	10	50	0.05	0.1	1	11	
BZG03C16	15.3	16	17.1	6	15	25	0.06	0.11	1	12	
BZG03C18	16.8	18	19.1	6	15	25	0.06	0.11	1	13	
BZG03C20	18.8	20	21.2	6	15	25	0.06	0.11	1	15	
BZG03C22	20.8	22	23.3	6	15	25	0.06	0.11	1	16	
BZG03C24	22.8	24	25.6	7	15	25	0.06	0.11	1	18	
BZG03C27	25.1	27	28.9	7	15	25	0.06	0.11	1	20	
BZG03C30	28	30	32	8	15	25	0.06	0.11	1	22	
BZG03C33	31	33	35	8	15	25	0.06	0.11	1	24	
BZG03C36	34	36	38	21	40	10	0.06	0.11	1	27	
BZG03C39	37	39	41	21	40	10	0.06	0.11	1	30	
BZG03C43	40	43	46	24	45	10	0.07	0.12	1	33	
BZG03C47	44	47	50	24	45	10	0.07	0.12	1	36	
BZG03C51	48	51	54	25	60	10	0.07	0.12	1	39	
BZG03C56	52	56	60	25	60	10	0.07	0.12	1	43	
BZG03C62	58	62	66	25	80	10	0.08	0.13	1	47	
BZG03C68	64	68	72	25	80	10	0.08	0.13	1	51	
BZG03C75	70	75	79	30	100	10	0.08	0.13	1	56	
BZG03C82	77	82	87	30	100	10	0.08	0.13	1	62	
BZG03C91	85	91	96	60	200	5	0.09	0.13	1	68	
BZG03C100	94	100	106	60	200	5	0.09	0.13	1	75	
BZG03C110	104	110	116	80	250	5	0.09	0.13	1	82	
BZG03C120	114	120	127	80	250	5	0.09	0.13	1	91	
BZG03C130	124	130	141	110	300	5	0.09	0.13	1	100	
BZG03C150	138	150	156	130	300	5	0.09	0.13	1	110	
BZG03C160	158	160	171	150	350	5	0.09	0.13	1	120	
BZG03C180	168	180	191	180	400	5	0.09	0.13	1	130	
BZG03C200	188	200	212	200	500	5	0.09	0.13	1	150	
BZG03C220	208	220	233	350	750	2	0.09	0.13	1	160	
BZG03C240	228	240	256	400	850	2	0.09	0.13	1	180	
BZG03C270	251	270	289	450	1000	2	0.09	0.13	1	200	

Typical Characteristics ($T_{amb} = 25\text{ }^{\circ}\text{C}$ unless otherwise specified)



94 9313

Figure 1. Boards for R_{thJA} definition (copper overlay $35\mu\text{m}$)



94 9581

Figure 3. Forward Current vs. Forward Voltage



94 9580

Figure 2. Total Power Dissipation vs. Ambient Temperature



94 9582

Figure 4. Non Repetitive Surge Power Dissipation vs. Pulse Length



94 9583

Figure 5. Thermal Response

BZG03C-Series

Vishay Semiconductors



Package Dimensions in mm (Inches)

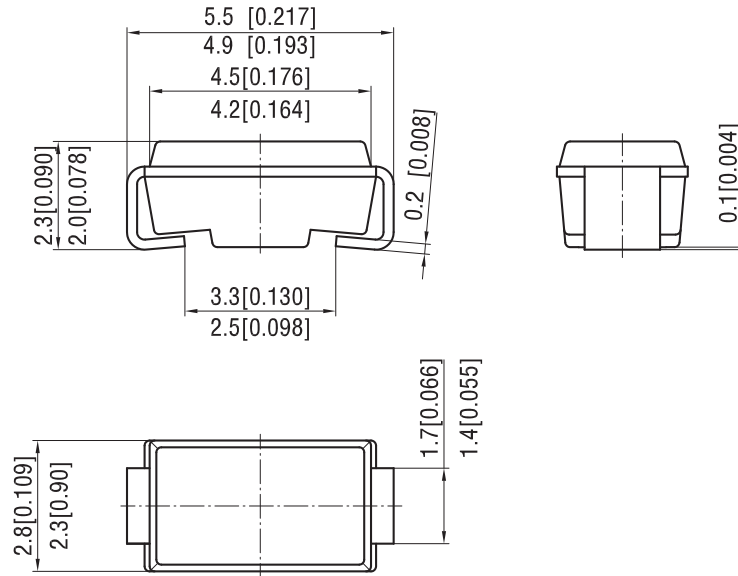

foot print recommendation:

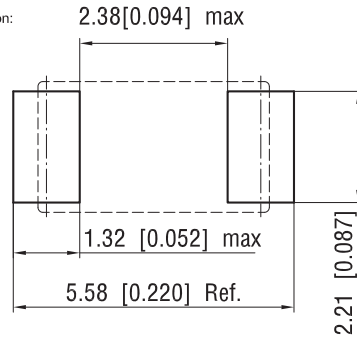

19628

Document no.:S8-V-3848.01-003 (4)

Rev. g - Date: 14.February.2005



Ozone Depleting Substances Policy Statement

It is the policy of Vishay Semiconductor GmbH to

1. Meet all present and future national and international statutory requirements.
2. Regularly and continuously improve the performance of our products, processes, distribution and operating systems with respect to their impact on the health and safety of our employees and the public, as well as their impact on the environment.

It is particular concern to control or eliminate releases of those substances into the atmosphere which are known as ozone depleting substances (ODSs).

The Montreal Protocol (1987) and its London Amendments (1990) intend to severely restrict the use of ODSs and forbid their use within the next ten years. Various national and international initiatives are pressing for an earlier ban on these substances.

Vishay Semiconductor GmbH has been able to use its policy of continuous improvements to eliminate the use of ODSs listed in the following documents.

1. Annex A, B and list of transitional substances of the Montreal Protocol and the London Amendments respectively
2. Class I and II ozone depleting substances in the Clean Air Act Amendments of 1990 by the Environmental Protection Agency (EPA) in the USA
3. Council Decision 88/540/EEC and 91/690/EEC Annex A, B and C (transitional substances) respectively.

Vishay Semiconductor GmbH can certify that our semiconductors are not manufactured with ozone depleting substances and do not contain such substances.

We reserve the right to make changes to improve technical design and may do so without further notice.

Parameters can vary in different applications. All operating parameters must be validated for each customer application by the customer. Should the buyer use Vishay Semiconductors products for any unintended or unauthorized application, the buyer shall indemnify Vishay Semiconductors against all claims, costs, damages, and expenses, arising out of, directly or indirectly, any claim of personal damage, injury or death associated with such unintended or unauthorized use.

Vishay Semiconductor GmbH, P.O.B. 3535, D-74025 Heilbronn, Germany



Disclaimer

All product specifications and data are subject to change without notice.

Vishay Intertechnology, Inc., its affiliates, agents, and employees, and all persons acting on its or their behalf (collectively, "Vishay"), disclaim any and all liability for any errors, inaccuracies or incompleteness contained herein or in any other disclosure relating to any product.

Vishay disclaims any and all liability arising out of the use or application of any product described herein or of any information provided herein to the maximum extent permitted by law. The product specifications do not expand or otherwise modify Vishay's terms and conditions of purchase, including but not limited to the warranty expressed therein, which apply to these products.

No license, express or implied, by estoppel or otherwise, to any intellectual property rights is granted by this document or by any conduct of Vishay.

The products shown herein are not designed for use in medical, life-saving, or life-sustaining applications unless otherwise expressly indicated. Customers using or selling Vishay products not expressly indicated for use in such applications do so entirely at their own risk and agree to fully indemnify Vishay for any damages arising or resulting from such use or sale. Please contact authorized Vishay personnel to obtain written terms and conditions regarding products designed for such applications.

Product names and markings noted herein may be trademarks of their respective owners.

Looking for pricing, stock, or lifecycle information?

Click below to explore more details on WIN SOURCE:

 [View BZG03C27TR3 on WIN SOURCE](#)

 [Vishay Information](#)

Optimize Your Supply Chain with WIN SOURCE Solutions

-  Global Sourcing Solution
-  Obsolete Management
-  Cost Control Management
-  Shortage Management
-  Alternative Solution
-  Excess Inventory Management