



# THE DATASHEET OF CMD5H-4E TR



CMDSH-4E

**ENHANCED SPECIFICATION  
SURFACE MOUNT SILICON  
SCHOTTKY DIODE**



www.centrasemi.com

**DESCRIPTION:**

The CENTRAL SEMICONDUCTOR CMDSH-4E is an enhanced version of the CMDSH-3 silicon Schottky diode in an SOD-323 surface mount package.

**ENHANCED SPECIFICATIONS:**

- ◆  $I_O$  from 100mA MAX to 200mA MAX
- ◆  $BV_R$  from 30V MIN to 40V MIN
- ◆  $V_F$  from 1.0V MAX to 0.8V MAX

**MARKING CODE: S1E**

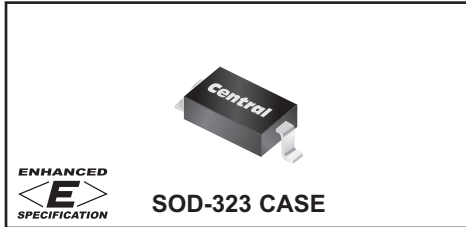

**MAXIMUM RATINGS:** ( $T_A=25^\circ\text{C}$ )

- ◆ **Peak Repetitive Reverse Voltage**
- ◆ **Average Forward Current**  
Peak Repetitive Forward Current  
Peak Forward Surge Current,  $t_p=10\text{ms}$   
Power Dissipation  
Operating and Storage Junction Temperature  
Thermal Resistance

SYMBOL		UNITS
$V_{RRM}$	40	V
$I_O$	200	mA
$I_{FRM}$	350	mA
$I_{FSM}$	750	mA
$P_D$	250	mW
$T_J, T_{stg}$	-65 to +150	$^\circ\text{C}$
$\theta_{JA}$	500	$^\circ\text{C/W}$

**ELECTRICAL CHARACTERISTICS:** ( $T_A=25^\circ\text{C}$  unless otherwise noted)

SYMBOL	TEST CONDITIONS	MIN	TYP	MAX	UNITS
$I_R$	$V_R=25\text{V}$		90	500	nA
$I_R$	$V_R=25\text{V}, T_A=100^\circ\text{C}$		25	100	$\mu\text{A}$
◆ $BV_R$	$I_R=100\mu\text{A}$	40	50		V
$V_F$	$I_F=2.0\text{mA}$		0.29	0.33	V
◆ $V_F$	$I_F=15\text{mA}$		0.37	0.42	V
◆ $V_F$	$I_F=100\text{mA}$		0.51	0.80	V
◆◆ $V_F$	$I_F=200\text{mA}$		0.65	1.0	V
$C_J$	$V_R=1.0\text{V}, f=1.0\text{MHz}$		7.0		pF
$t_{rr}$	$I_F=I_R=10\text{mA}, I_{rr}=1.0\text{mA}, R_L=100\Omega$			5.0	ns

- ◆ Enhanced specification.
- ◆◆ Additional Enhanced specification.

CMDSH-4E

**ENHANCED SPECIFICATION  
SURFACE MOUNT SILICON  
SCHOTTKY DIODE**



**SOD-323 CASE - MECHANICAL OUTLINE**

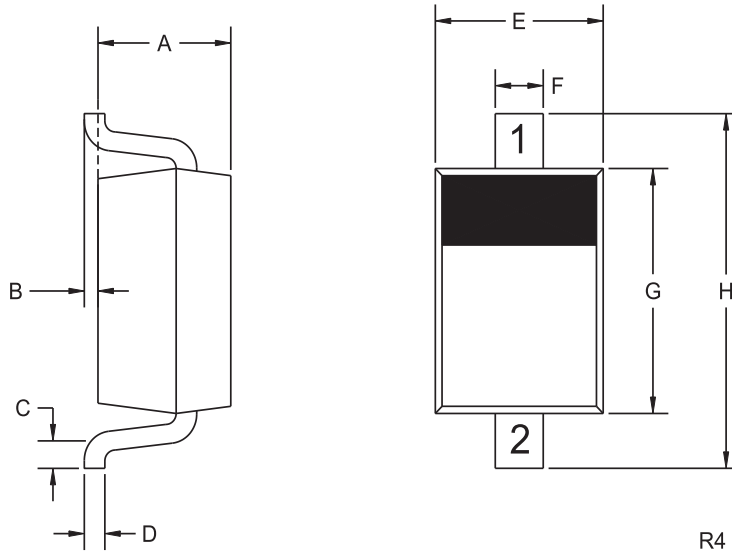

**LEAD CODE:**

- 1) Cathode
- 2) Anode

**MARKING CODE: S1E**

DIMENSIONS				
SYMBOL	INCHES		MILLIMETERS	
	MIN	MAX	MIN	MAX
A	0.031	0.039	0.80	1.00
B	0.000	0.004	0.00	0.10
C	0.008	-	0.20	-
D	0.004	0.007	0.11	0.19
E	0.045	0.053	1.15	1.35
F	-	0.014	-	0.35
G	0.063	0.071	1.60	1.80
H	0.094	0.102	2.40	2.60

SOD-323 (REV: R4)

R3 (11-February 2016)

**CMDSH-4E**

**ENHANCED SPECIFICATION  
SURFACE MOUNT SILICON  
SCHOTTKY DIODE**



**TYPICAL ELECTRICAL CHARACTERISTICS**

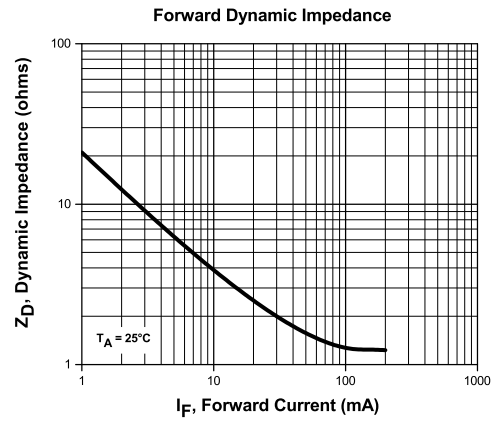
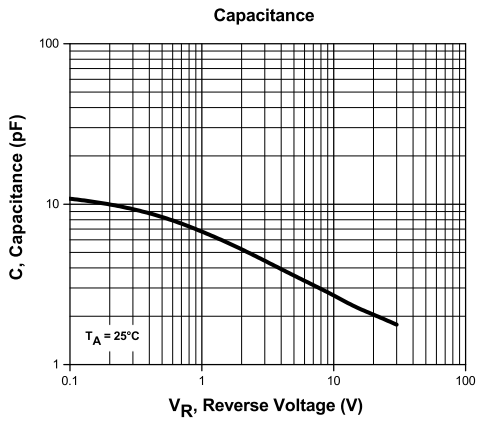
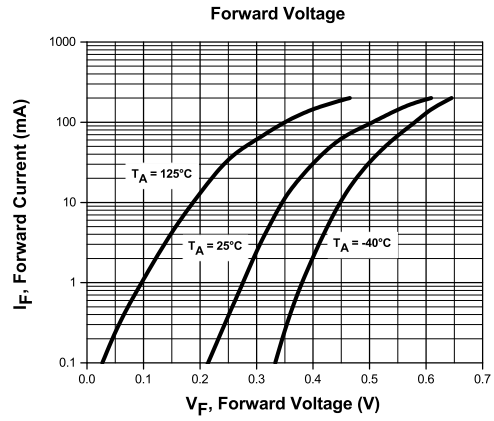
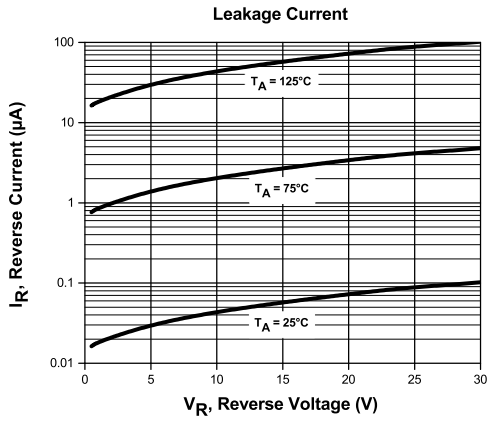

R3 (11-February 2016)

CMDSH-4E

**ENHANCED SPECIFICATION  
SURFACE MOUNT SILICON  
SCHOTTKY DIODE**



**TYPICAL ELECTRICAL CHARACTERISTICS**

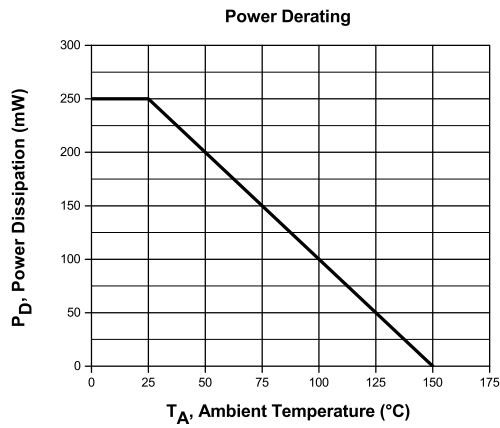
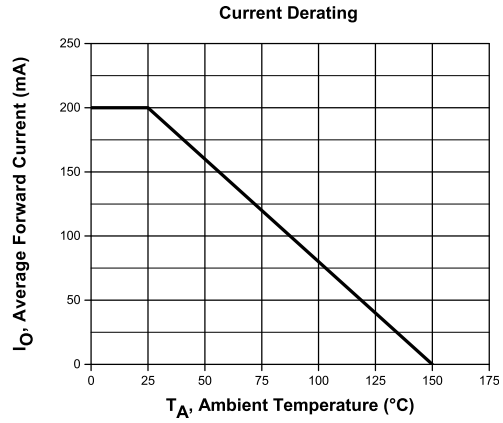
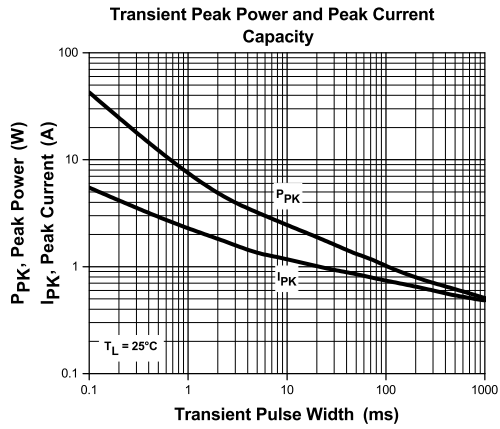

R3 (11-February 2016)

## OUTSTANDING SUPPORT AND SUPERIOR SERVICES



---

### PRODUCT SUPPORT

Central's operations team provides the highest level of support to insure product is delivered on-time.

- Supply management (Customer portals)
- Inventory bonding
- Consolidated shipping options
- Custom bar coding for shipments
- Custom product packing

---

### DESIGNER SUPPORT/SERVICES

Central's applications engineering team is ready to discuss your design challenges. Just ask.

- Free quick ship samples (2<sup>nd</sup> day air)
- Online technical data and parametric search
- SPICE models
- Custom electrical curves
- Environmental regulation compliance
- Customer specific screening
- Up-screening capabilities
- Special wafer diffusions
- PbSn plating options
- Package details
- Application notes
- Application and design sample kits
- Custom product and package development

---

### REQUESTING PRODUCT PLATING

1. If requesting Tin/Lead plated devices, add the suffix " TIN/LEAD" to the part number when ordering (example: 2N2222A TIN/LEAD).
2. If requesting Lead (Pb) Free plated devices, add the suffix " PBFREE" to the part number when ordering (example: 2N2222A PBFREE).

---

### CONTACT US

#### Corporate Headquarters & Customer Support Team

Central Semiconductor Corp.  
145 Adams Avenue  
Hauppauge, NY 11788 USA  
Main Tel: (631) 435-1110  
Main Fax: (631) 435-1824  
Support Team Fax: (631) 435-3388  
[www.centrasemi.com](http://www.centrasemi.com)

**Worldwide Field Representatives:**  
[www.centrasemi.com/wwreps](http://www.centrasemi.com/wwreps)



**Worldwide Distributors:**  
[www.centrasemi.com/wwdistributors](http://www.centrasemi.com/wwdistributors)

---

For the latest version of Central Semiconductor's **LIMITATIONS AND DAMAGES DISCLAIMER**, which is part of Central's Standard Terms and Conditions of sale, visit: [www.centrasemi.com/terms](http://www.centrasemi.com/terms)

## Looking for pricing, stock, or lifecycle information?

Click below to explore more details on WIN SOURCE:

-  [View CMDSH-4E TR on WIN SOURCE](#)
-  [Central Semiconductor Corp Information](#)

## Optimize Your Supply Chain with WIN SOURCE Solutions

-  Global Sourcing Solution
-  Obsolete Management
-  Cost Control Management
-  Shortage Management
-  Alternative Solution
-  Excess Inventory Management