



**THE DATASHEET OF  
TPS78930DBVT**



# TPS78915, TPS78918, TPS78925, TPS78928, TPS78930 ULTRALOW-POWER LOW-NOISE 100-mA LOW-DROPOUT LINEAR REGULATORS

SLVS300A – SEPTEMBER 2000 – REVISED MAY 2001

- 100-mA Low-Dropout Regulator
- Available in 1.5-V, 1.8-V, 2.5-V, 2.8-V, 3.0-V
- Output Noise Typically 56  $\mu\text{V}_{\text{RMS}}$  (TPS78930)
- Only 17  $\mu\text{A}$  Quiescent Current at 100 mA
- 1  $\mu\text{A}$  Quiescent Current in Standby Mode
- Dropout Voltage Typically 115 mV at 100 mA (TPS78930)
- Over Current Limitation
- $-40^{\circ}\text{C}$  to  $125^{\circ}\text{C}$  Operating Junction Temperature Range
- 5-Pin SOT-23 (DBV) Package

## description

The TPS789xx family of low-dropout (LDO) voltage regulators offers the benefits of low-dropout voltage, ultralow-power operation, low-output noise, and miniaturized packaging. These regulators feature low-dropout voltages and ultralow quiescent current compared to conventional LDO regulators. An internal resistor, in conjunction with an external bypass capacitor, creates a low-pass filter to reduce the noise. The TPS78930 exhibits only 56  $\mu\text{V}_{\text{RMS}}$  of output voltage noise using 0.01  $\mu\text{F}$  bypass and 10  $\mu\text{F}$  output capacitors. Offered in a 5-terminal small outline integrated-circuit SOT-23 package, the TPS789xx series devices are ideal for micropower operations, low output noise, and where board space is limited.

The usual PNP pass transistor has been replaced by a PMOS pass element. Because the PMOS pass element behaves as a low-value resistor, the dropout voltage is very low, typically 115 mV at 100 mA of load current (TPS78930), and is directly proportional to the load current. The quiescent current is ultralow (17  $\mu\text{A}$  typically) and is stable over the entire range of output load current (0 mA to 100 mA). Intended for use in portable systems such as laptops and cellular phones, the ultralow-dropout voltage feature and ultralow-power operation result in a significant increase in system battery operating life.

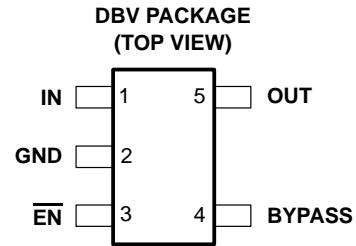

TPS78930  
GROUND CURRENT  
vs  
JUNCTION TEMPERATURE

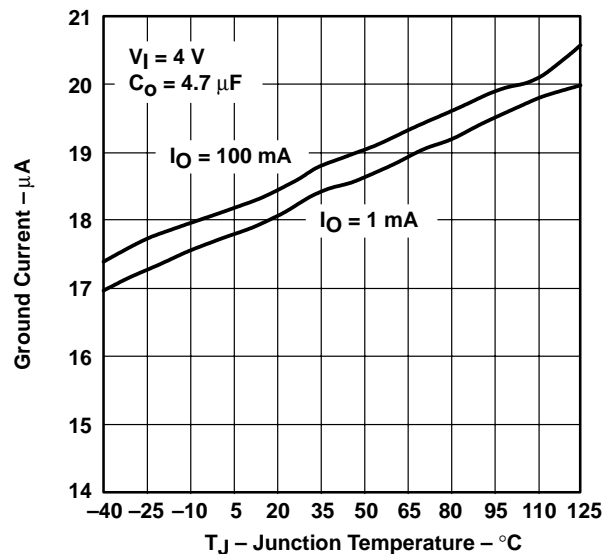

TPS78930  
OUTPUT SPECTRAL NOISE DENSITY  
vs  
FREQUENCY

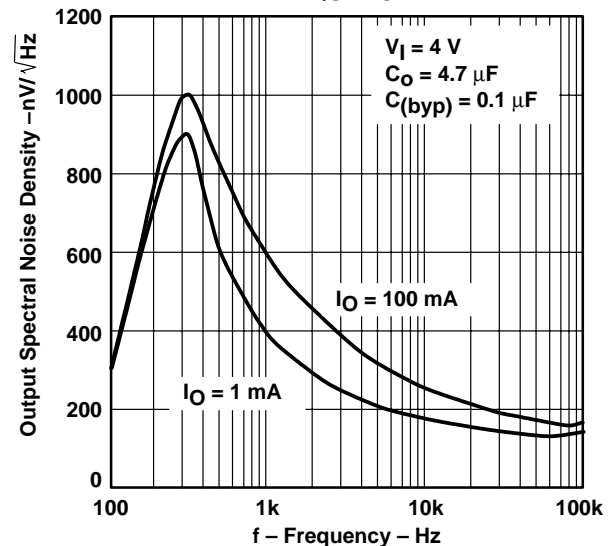

Please be aware that an important notice concerning availability, standard warranty, and use in critical applications of Texas Instruments semiconductor products and disclaimers thereto appears at the end of this data sheet.

PRODUCTION DATA information is current as of publication date. Products conform to specifications per the terms of Texas Instruments standard warranty. Production processing does not necessarily include testing of all parameters.

 **TEXAS  
INSTRUMENTS**

POST OFFICE BOX 655303 • DALLAS, TEXAS 75265

Copyright © 2001, Texas Instruments Incorporated

# TPS78915, TPS78918, TPS78925, TPS78928, TPS78930

## ULTRALOW-POWER LOW-NOISE 100-mA

### LOW-DROPOUT LINEAR REGULATORS

SLVS300A – SEPTEMBER 2000 – REVISED MAY 2001

#### description (continued)

The TPS789xx also features a logic-enabled sleep mode to shut down the regulator, reducing quiescent current to 1  $\mu$ A typical at  $T_J = 25^\circ\text{C}$ . The TPS789xx is offered in 1.5 V, 1.8 V, 2.5 V, 2.8 V, and 3.0 V.

#### AVAILABLE OPTIONS

$T_J$	VOLTAGE	PACKAGE	PART NUMBER		SYMBOL
-40°C to 125°C	1.5 V	SOT-23 (DBV)	TPS78915DBVT†	TPS78915DBVR‡	PDWI
	1.8 V		TPS78918DBVT†	TPS78918DBVR‡	PDXI
	2.5 V		TPS78925DBVT†	TPS78925DBVR‡	PDYI
	2.8 V		TPS78928DBVT†	TPS78928DBVR‡	PDZI
	3.0 V		TPS78930DBVT†	TPS78930DBVR‡	PEAI

† The DBVT indicates tape and reel of 250 parts.

‡ The DBVR indicates tape and reel of 3000 parts.

#### functional block diagram

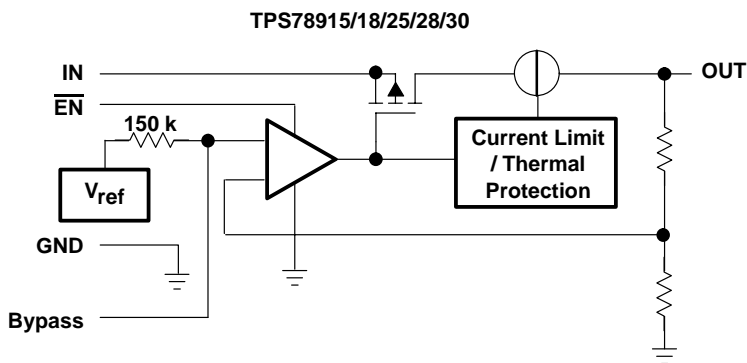

#### Terminal Functions

TERMINAL NAME	NO.	I/O	DESCRIPTION
BYPASS	4	I	The external bypass capacitor, in conjunction with an internal resistor, creates a low-pass filter to further reduce regulator noise.
EN	3	I	Active low enable.
GND	2		Regulator ground
IN	1	I	The IN terminal is the input to the device.
OUT	5	O	The OUT terminal is the regulated output of the device.

# TPS78915, TPS78918, TPS78925, TPS78928, TPS78930 ULTRALOW-POWER LOW-NOISE 100-mA LOW-DROPOUT LINEAR REGULATORS

SLVS300A – SEPTEMBER 2000 – REVISED MAY 2001

## detail description

The TPS789xx uses a PMOS pass element to dramatically reduce both dropout voltage and supply current over more conventional PNP-pass-element LDO designs. The PMOS pass element is a voltage-controlled device and, unlike a PNP transistor, it does not require increased drive current as output current increases. Supply current in the TPS789xx is essentially constant from no load to maximum load.

The TPS789xx family of low-dropout (LDO) regulators have been optimized for use in battery-operated equipment. They feature extremely low dropout voltages, low output noise, low quiescent current (17  $\mu$ A typically), and enable inputs to reduce supply currents to 1  $\mu$ A when the regulators are turned off.

The internal voltage reference is a key source of noise in a LDO regulator. The TPS789xx has a BYPASS pin which is connected to the voltage reference through a 150-k $\Omega$  internal resistor. The 150-k $\Omega$  internal resistor, in conjunction with an external bypass capacitor connected to the BYPASS pin, creates a low pass filter to reduce the voltage reference noise and, therefore, the noise at the regulator output. Note that the output will start up slower as the bypass capacitance increases due to the RC time constant at the bypass pin that is created by the internal 150-k $\Omega$  resistor and external capacitor.

Current limiting and thermal protection prevent damage by excessive output current and/or power dissipation. The device switches into a constant-current mode at approximately 350 mA; further load reduces the output voltage instead of increasing the output current. The thermal protection shuts the regulator off if the junction temperature rises above approximately 165°C. Recovery is automatic when the junction temperature drops approximately 25°C below the high temperature trip point. The PMOS pass element includes a back gate diode that conducts reverse current when the input voltage level drops below the output voltage level.

A voltage of 1.7 V or greater on the  $\overline{\text{EN}}$  input will disable the TPS789xx internal circuitry, reducing the supply current to 1  $\mu$ A. A voltage of less than 0.9 V on the  $\overline{\text{EN}}$  input will enable the TPS789xx and will enable normal operation to resume. The  $\overline{\text{EN}}$  input does not include any deliberate hysteresis, and it exhibits an actual switching threshold of approximately 1.5 V.

## absolute maximum ratings over operating free-air temperature range (unless otherwise noted)<sup>†</sup>

Input voltage range (see Note 1)	–0.3 V to 13.5 V
Voltage range at $\overline{\text{EN}}$	–0.3 V to $V_I + 0.3$ V
Voltage on OUT	7 V
Peak output current	Internally limited
ESD rating, HBM	2 kV
Continuous total power dissipation	See Dissipation Rating Table
Operating virtual junction temperature range, $T_J$	–40°C to 150°C
Storage temperature range, $T_{\text{stg}}$	–65°C to 150°C

<sup>†</sup> Stresses beyond those listed under “absolute maximum ratings” may cause permanent damage to the device. These are stress ratings only, and functional operation of the device at these or any other conditions beyond those indicated under “recommended operating conditions” is not implied. Exposure to absolute-maximum-rated conditions for extended periods may affect device reliability.

NOTE 1: All voltage values are with respect to network ground terminal.

**DISSIPATION RATING TABLE**

BOARD	PACKAGE	$R_{\theta JC}$	$R_{\theta JA}$	DERATING FACTOR ABOVE $T_A = 25^\circ\text{C}$	$T_A \leq 25^\circ\text{C}$ POWER RATING	$T_A = 70^\circ\text{C}$ POWER RATING	$T_A = 85^\circ\text{C}$ POWER RATING
Low K <sup>‡</sup>	DBV	65.8 °C/W	259 °C/W	3.9 mW/°C	386 mW	212 mW	154 mW
High K <sup>§</sup>	DBV	65.8 °C/W	180 °C/W	5.6 mW/°C	555 mW	305 mW	222 mW

<sup>‡</sup> The JEDEC Low K (1s) board design used to derive this data was a 3 inch x 3 inch, two layer board with 2 ounce copper traces on top of the board.

<sup>§</sup> The JEDEC High K (2s2p) board design used to derive this data was a 3 inch x 3 inch, multilayer board with 1 ounce internal power and ground planes and 2 ounce copper traces on top and bottom of the board.



**TPS78915, TPS78918, TPS78925, TPS78928, TPS78930**  
**ULTRALOW-POWER LOW-NOISE 100-mA**  
**LOW-DROPOUT LINEAR REGULATORS**

SLVS300A – SEPTEMBER 2000 – REVISED MAY 2001

**recommended operating conditions**

	MIN	NOM	MAX	UNIT
Input voltage, $V_I$ (see Note 2)	2.7		10	V
Continuous output current, $I_O$ (see Note 3)	0		100	mA
Operating junction temperature, $T_J$	-40		125	°C

NOTES: 2. To calculate the minimum input voltage for your maximum output current, use the following formula:

$$V_{I(\min)} = V_{O(\max)} + V_{DO}(\text{max load})$$

3. Continuous output current and operating junction temperature are limited by internal protection circuitry, but it is not recommended that the device operate under conditions beyond those specified in this table for extended periods of time.

**electrical characteristics over recommended operating free-air temperature range,**  
 $V_I = V_{O(\text{typ})} + 1 \text{ V}$ ,  $I_O = 1 \text{ mA}$ ,  $\overline{\text{EN}} = 0 \text{ V}$ ,  $C_O = 4.7 \mu\text{F}$  (unless otherwise noted)

PARAMETER		TEST CONDITIONS	MIN	TYP	MAX	UNIT		
Output voltage (see Note 4)	TPS78915	$T_J = 25^\circ\text{C}$ , $2.7 \text{ V} < V_I < 10 \text{ V}$		1.5		V		
		$T_J = -40^\circ\text{C}$ to $125^\circ\text{C}$ , $2.7 \text{ V} < V_I < 10 \text{ V}$	1.455		1.545			
	TPS78918	$T_J = 25^\circ\text{C}$ , $2.8 \text{ V} < V_I < 10 \text{ V}$		1.8				
		$T_J = -40^\circ\text{C}$ to $125^\circ\text{C}$ , $2.8 \text{ V} < V_I < 10 \text{ V}$	1.746		1.854			
	TPS78925	$T_J = 25^\circ\text{C}$ , $3.5 \text{ V} < V_I < 10 \text{ V}$		2.5				
		$T_J = -40^\circ\text{C}$ to $125^\circ\text{C}$ , $3.5 \text{ V} < V_I < 10 \text{ V}$	2.425		2.575			
	TPS78928	$T_J = 25^\circ\text{C}$ , $3.8 \text{ V} < V_I < 10 \text{ V}$		2.8				
		$T_J = -40^\circ\text{C}$ to $125^\circ\text{C}$ , $3.8 \text{ V} < V_I < 10 \text{ V}$	2.716		2.884			
	TPS78930	$T_J = 25^\circ\text{C}$ , $4.0 \text{ V} < V_I < 10 \text{ V}$		3				
		$T_J = -40^\circ\text{C}$ to $125^\circ\text{C}$ , $4.0 \text{ V} < V_I < 10 \text{ V}$	2.910		3.090			
	Quiescent current (GND current) (see Notes 4 and 5)		$\overline{\text{EN}} = 0 \text{ V}$ , $10 \mu\text{A} < I_O < 100 \text{ mA}$ , $T_J = 25^\circ\text{C}$		17			$\mu\text{A}$
			$\overline{\text{EN}} = 0 \text{ V}$ , $I_O = 100 \text{ mA}$ , $T_J = -40^\circ\text{C}$ to $125^\circ\text{C}$				28	
Load regulation		$\overline{\text{EN}} = 0 \text{ V}$ , $I_O = \text{See Note 4}$ , $T_J = 25^\circ\text{C}$		12		mV		
Output voltage line regulation ( $\Delta V_O/V_O$ ) (see Note 5)		$V_O + 1 \text{ V} < V_I \leq 10 \text{ V}$ , $T_J = 25^\circ\text{C}$ , See Note 4		0.04		%V		
		$V_O + 1 \text{ V} < V_I \leq 10 \text{ V}$ , $T_J = -40^\circ\text{C}$ to $125^\circ\text{C}$ , See Note 4			0.1			
Output noise voltage (TPS78930)		BW = 300 Hz to 50 kHz, $C_{(\text{byp})} = 0.01 \mu\text{F}$ , $C_O = 10 \mu\text{F}$ , $I_O = 100 \text{ mA}$ , $T_J = 25^\circ\text{C}$		56		$\mu\text{VRMS}$		
Output current limit		$V_O = 0 \text{ V}$ , See Note 4		350	750	mA		
Standby current		$\overline{\text{EN}} = V_I$ , $2.7 < V_I < 10 \text{ V}$		1		$\mu\text{A}$		
		$T_J = -40^\circ\text{C}$ to $125^\circ\text{C}$			2	$\mu\text{A}$		

NOTES: 4. The minimum IN operating voltage is 2.7 V or  $V_{O(\text{typ})} + 1 \text{ V}$ , whichever is greater. The maximum IN voltage is 10 V. The minimum output current is 10  $\mu\text{A}$  and the maximum output current is 100 mA.

5. If  $V_O \leq 1.8 \text{ V}$  then  $V_{I\min} = 2.7 \text{ V}$ ,  $V_{I\max} = 10 \text{ V}$ :

$$\text{Line Reg. (mV)} = (\%/V) \times \frac{V_O(V_{I\max} - 2.7 \text{ V})}{100} \times 1000$$

If  $V_O \geq 2.5 \text{ V}$  then  $V_{I\min} = V_O + 1 \text{ V}$ ,  $V_{I\max} = 10 \text{ V}$ :

$$\text{Line Reg. (mV)} = (\%/V) \times \frac{V_O(V_{I\max} - (V_O + 1 \text{ V}))}{100} \times 1000$$



**TPS78915, TPS78918, TPS78925, TPS78928, TPS78930**  
**ULTRALOW-POWER LOW-NOISE 100-mA**  
**LOW-DROPOUT LINEAR REGULATORS**

SLVS300A – SEPTEMBER 2000 – REVISED MAY 2001

**electrical characteristics over recommended operating free-air temperature range,**  
 $V_I = V_{O(\text{typ})} + 1 \text{ V}$ ,  $I_O = 1 \text{ mA}$ ,  $\overline{EN} = 0 \text{ V}$ ,  $C_O = 4.7 \mu\text{F}$  (unless otherwise noted) (continued)

PARAMETER		TEST CONDITIONS	MIN	TYP	MAX	UNIT
High level enable input voltage		$2.7 \text{ V} < V_I < 10 \text{ V}$	1.7			V
Low level enable input voltage		$2.7 \text{ V} < V_I < 10 \text{ V}$			0.9	V
Power supply ripple rejection (TPS78930)		$f = 1 \text{ kHz}$ , $T_J = 25^\circ\text{C}$ , $C_O = 10 \mu\text{F}$ , $C(\text{byp}) = 0.01 \mu\text{F}$		85		dB
Input current (EN)		$\overline{EN} = 0 \text{ V}$	-1	0	1	$\mu\text{A}$
		$\overline{EN} = V_I$	-1		1	$\mu\text{A}$
Dropout voltage (see Note 6)	TPS78928	$I_O = 50 \text{ mA}$ , $T_J = 25^\circ\text{C}$		60		mV
		$I_O = 50 \text{ mA}$ , $T_J = -40^\circ\text{C to } 125^\circ\text{C}$			125	
		$I_O = 100 \text{ mA}$ , $T_J = 25^\circ\text{C}$		122		
		$I_O = 100 \text{ mA}$ , $T_J = -40^\circ\text{C to } 125^\circ\text{C}$			245	
	TPS78930	$I_O = 50 \text{ mA}$ , $T_J = 25^\circ\text{C}$		57		
		$I_O = 50 \text{ mA}$ , $T_J = -40^\circ\text{C to } 125^\circ\text{C}$			115	
		$I_O = 100 \text{ mA}$ , $T_J = 25^\circ\text{C}$		115		
		$I_O = 100 \text{ mA}$ , $T_J = -40^\circ\text{C to } 125^\circ\text{C}$			230	

NOTE 6.  $I_N$  voltage equals  $V_{O(\text{typ})} - 100 \text{ mV}$ ; The TPS78930 output voltage is set to 2.9 V. The TPS78915, TPS78918, and TPS78925 dropout voltage is limited by the input voltage range limitations.

## TYPICAL CHARACTERISTICS

### Table of Graphs

			FIGURE
$V_O$	Output voltage	vs Output current	1, 2, 3
		vs Junction temperature	4, 5, 6
	Ground current	vs Junction temperature	7
	Output spectral noise density	vs Frequency	8 – 10
	Root mean squared output noise	vs Bypass capacitance	11
$Z_O$	Output impedance	vs Frequency	12
$V_{DO}$	Dropout voltage	vs Junction temperature	13
		Ripple rejection	vs Frequency
$V_O$	Output voltage, enable voltage	vs Time (start-up)	17 – 19
	Line transient response		20, 22
	Load transient response		21, 23
	Equivalent series resistance (ESR)	vs Output current	24, 25



**TPS78915, TPS78918, TPS78925, TPS78928, TPS78930**  
**ULTRALOW-POWER LOW-NOISE 100-mA**  
**LOW-DROPOUT LINEAR REGULATORS**

SLVS300A – SEPTEMBER 2000 – REVISED MAY 2001

**TYPICAL CHARACTERISTICS**

**TPS78925**  
**OUTPUT VOLTAGE**  
**vs**  
**OUTPUT CURRENT**

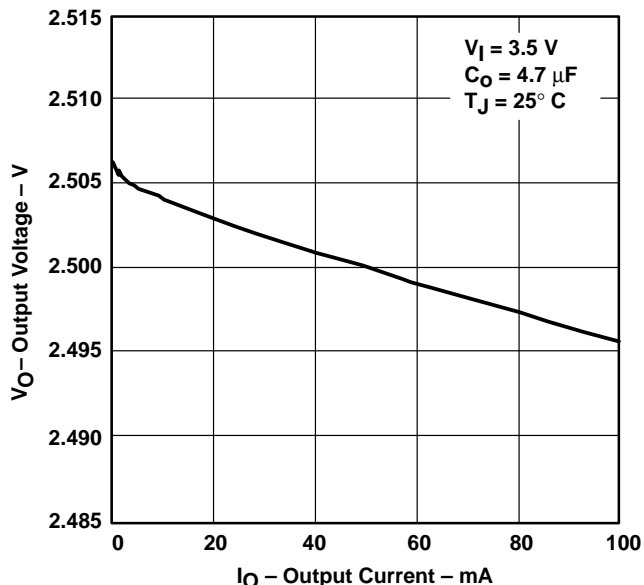

**Figure 1**

**TPS78915**  
**OUTPUT VOLTAGE**  
**vs**  
**OUTPUT CURRENT**

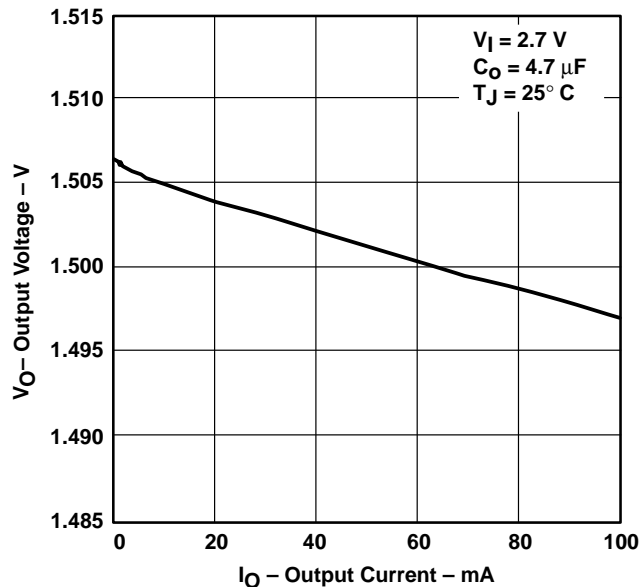

**Figure 2**

**TPS78930**  
**OUTPUT VOLTAGE**  
**vs**  
**OUTPUT CURRENT**

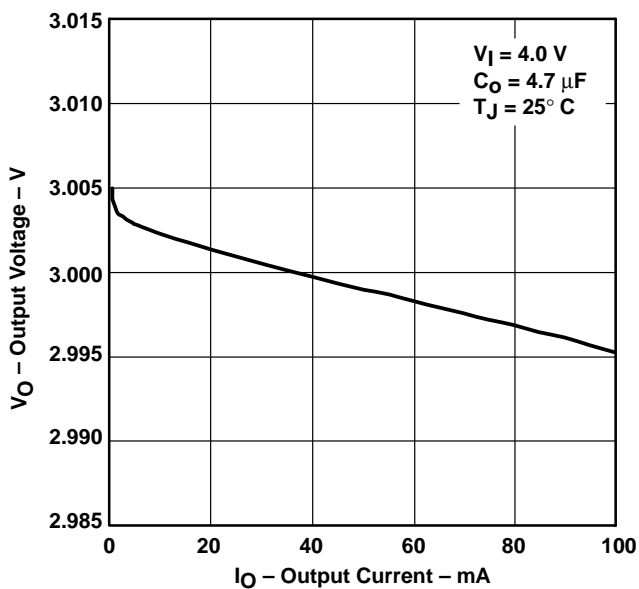

**Figure 3**

**TPS78915**  
**OUTPUT VOLTAGE**  
**vs**  
**JUNCTION TEMPERATURE**

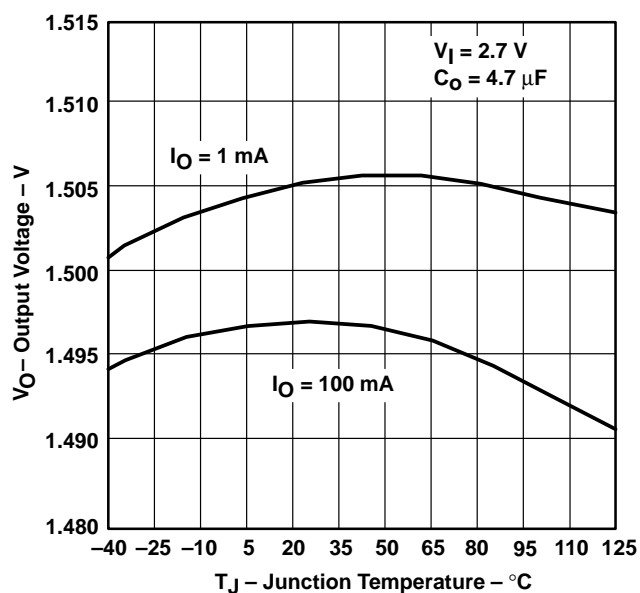

**Figure 4**



TPS78915, TPS78918, TPS78925, TPS78928, TPS78930  
**ULTRALOW-POWER LOW-NOISE 100-mA  
 LOW-DROPOUT LINEAR REGULATORS**

SLVS300A – SEPTEMBER 2000 – REVISED MAY 2001

**TYPICAL CHARACTERISTICS**

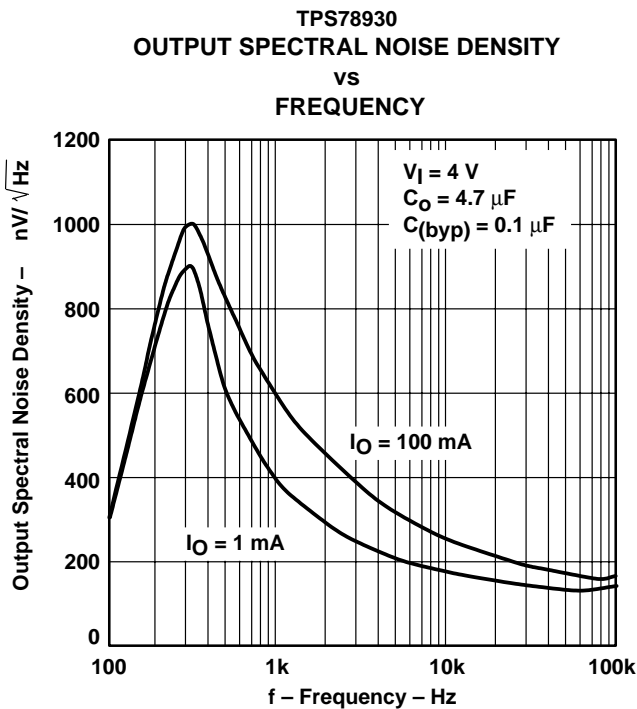
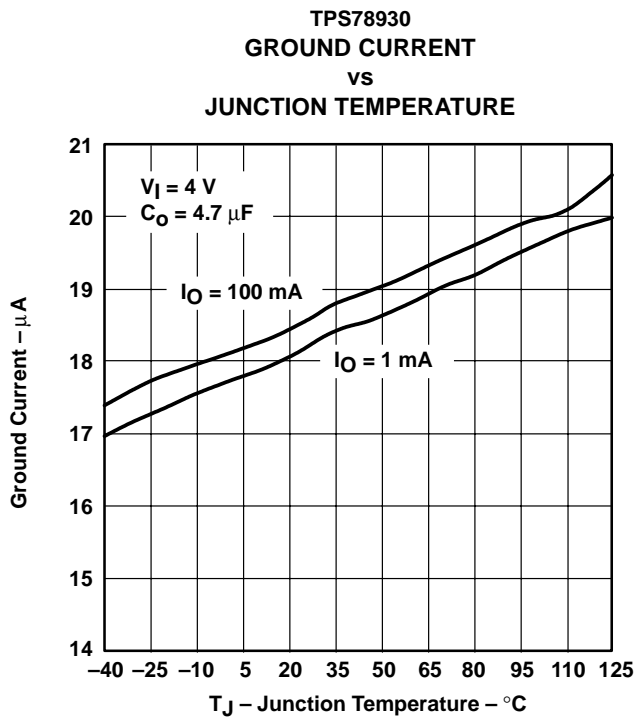
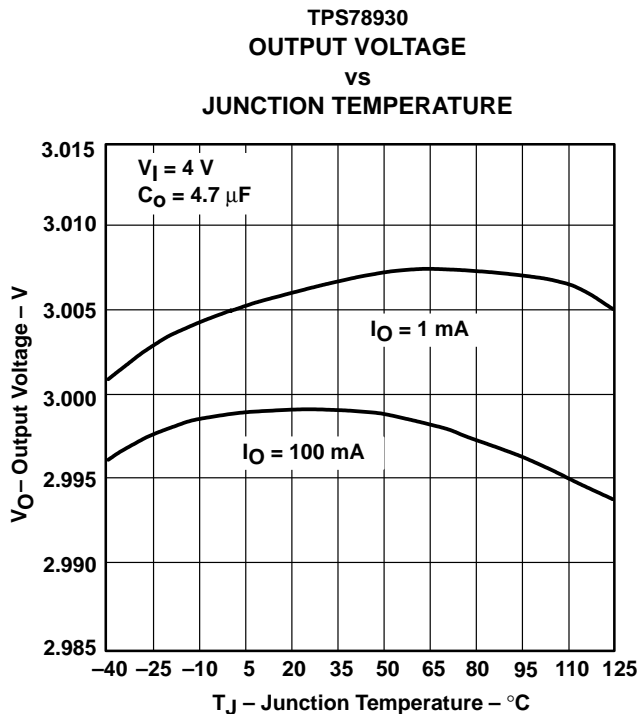
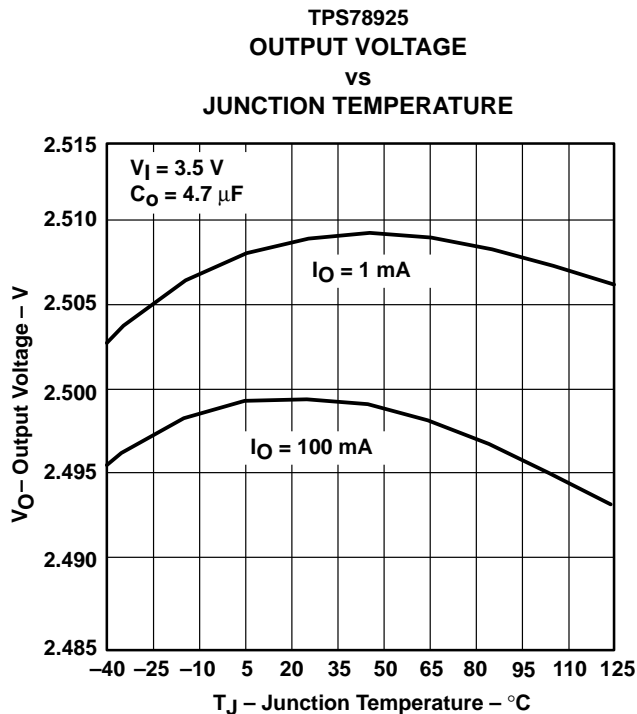

**TPS78915, TPS78918, TPS78925, TPS78928, TPS78930**  
**ULTRALOW-POWER LOW-NOISE 100-mA**  
**LOW-DROPOUT LINEAR REGULATORS**

SLVS300A – SEPTEMBER 2000 – REVISED MAY 2001

**TYPICAL CHARACTERISTICS**

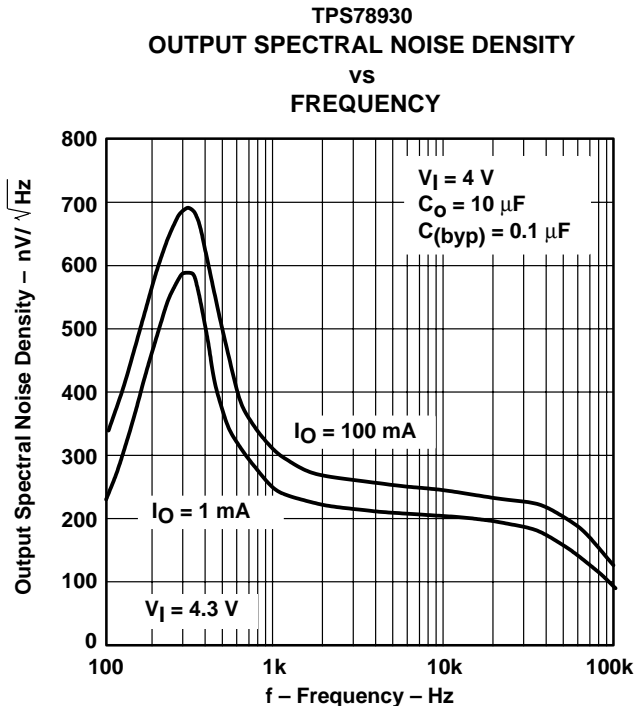

Figure 9

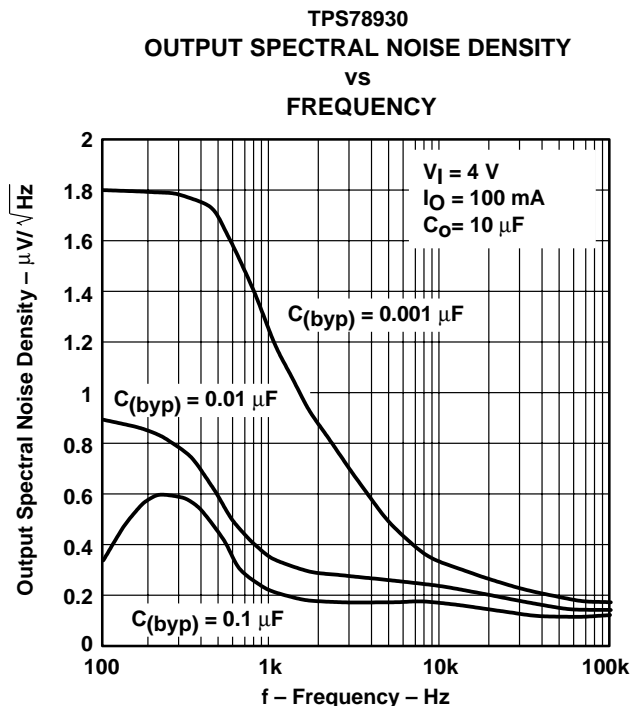

Figure 10

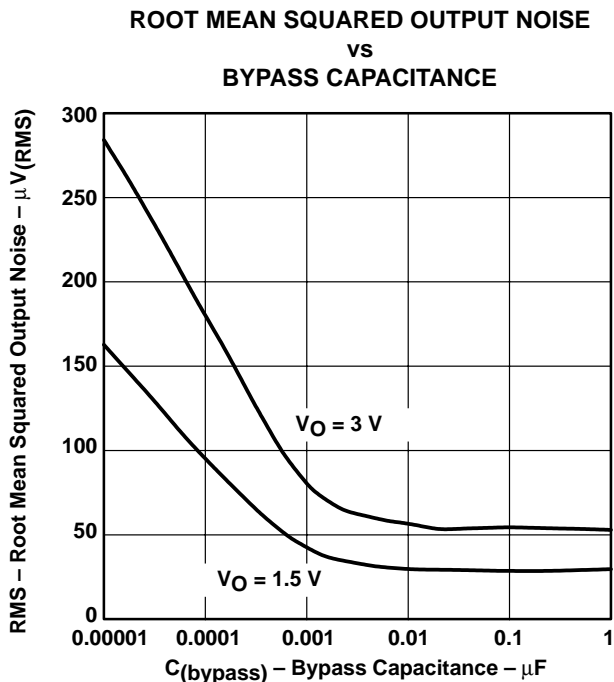

Figure 11

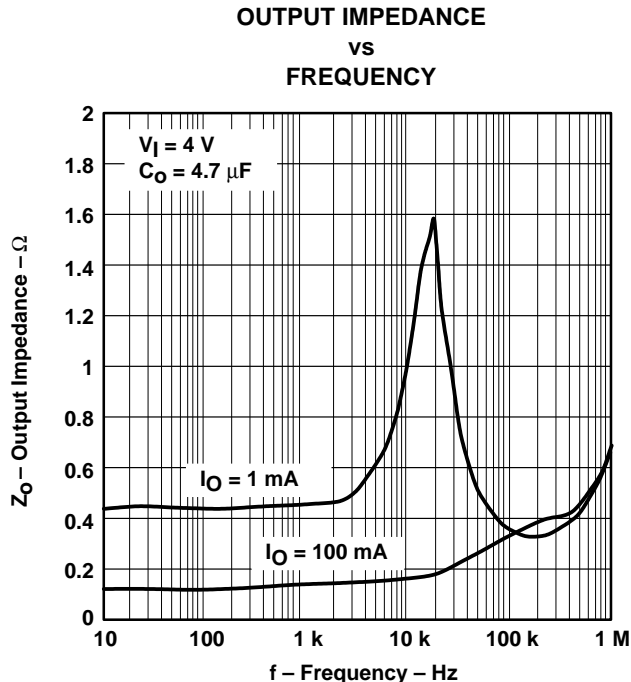

Figure 12



TYPICAL CHARACTERISTICS

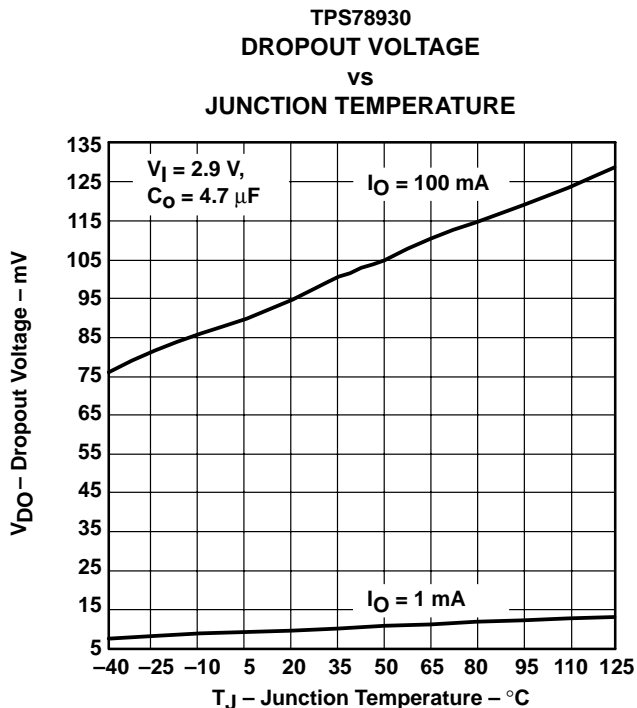

Figure 13

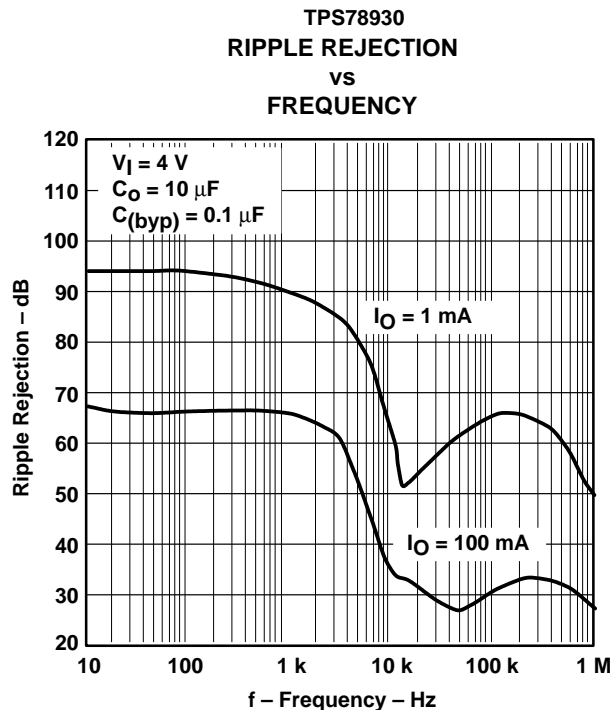

Figure 14

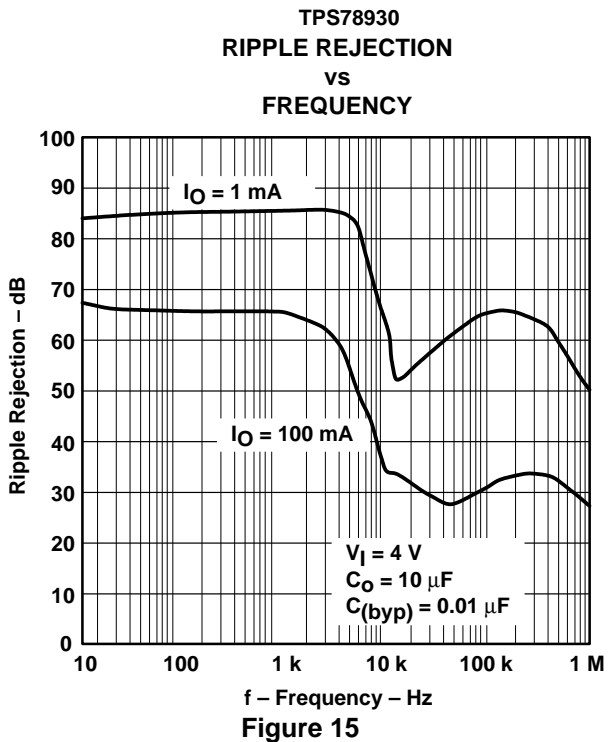

Figure 15

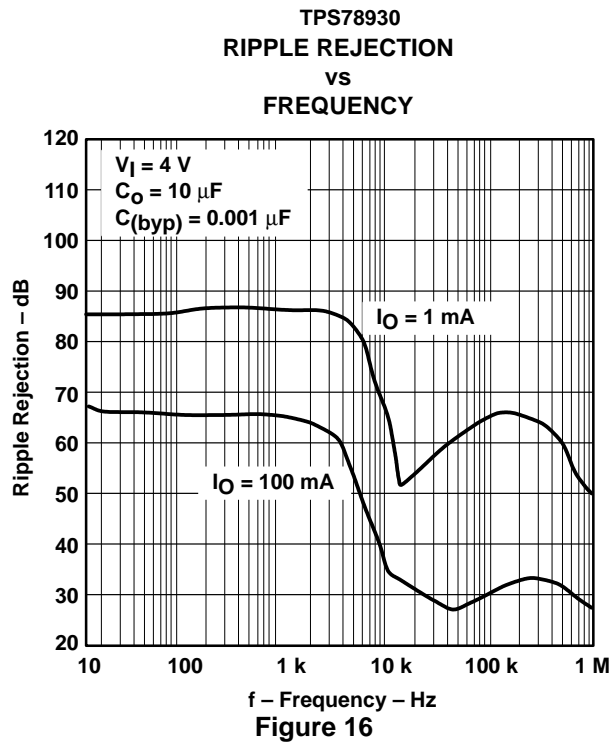

Figure 16

**TPS78915, TPS78918, TPS78925, TPS78928, TPS78930**  
**ULTRALOW-POWER LOW-NOISE 100-mA**  
**LOW-DROPOUT LINEAR REGULATORS**

SLVS300A – SEPTEMBER 2000 – REVISED MAY 2001

**TYPICAL CHARACTERISTICS**

**TPS78930**  
**OUTPUT VOLTAGE, ENABLE VOLTAGE**  
**vs**  
**TIME (START-UP)**

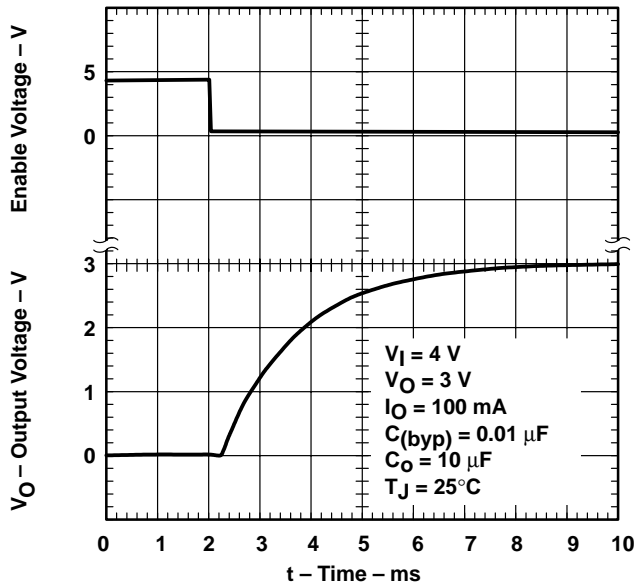

**Figure 17**

**TPS78930**  
**OUTPUT VOLTAGE, ENABLE VOLTAGE**  
**vs**  
**TIME (START-UP)**

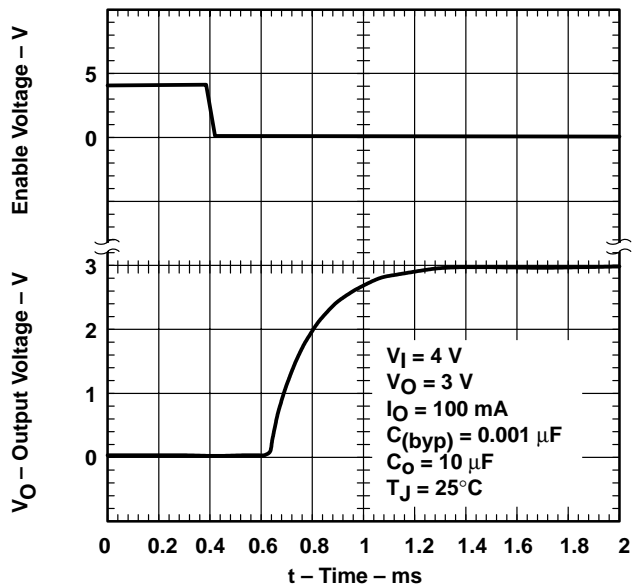

**Figure 18**

**TPS78930**  
**OUTPUT VOLTAGE, ENABLE VOLTAGE**  
**vs**  
**TIME (START-UP)**

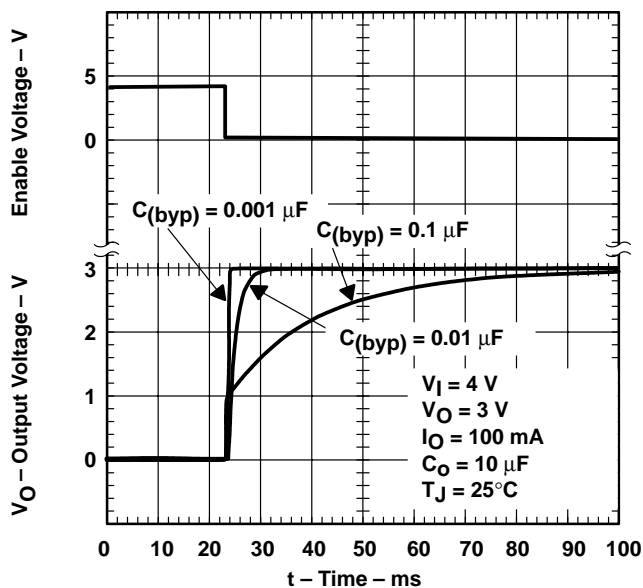

**Figure 19**



TYPICAL CHARACTERISTICS

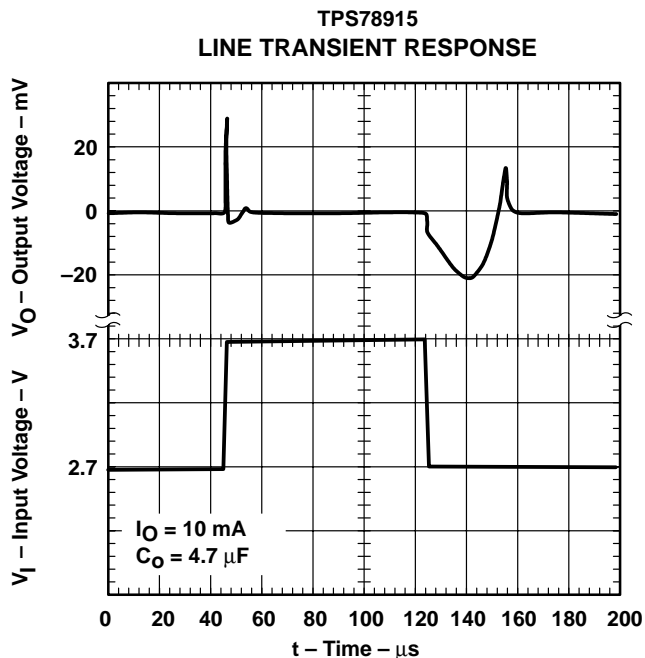

Figure 20

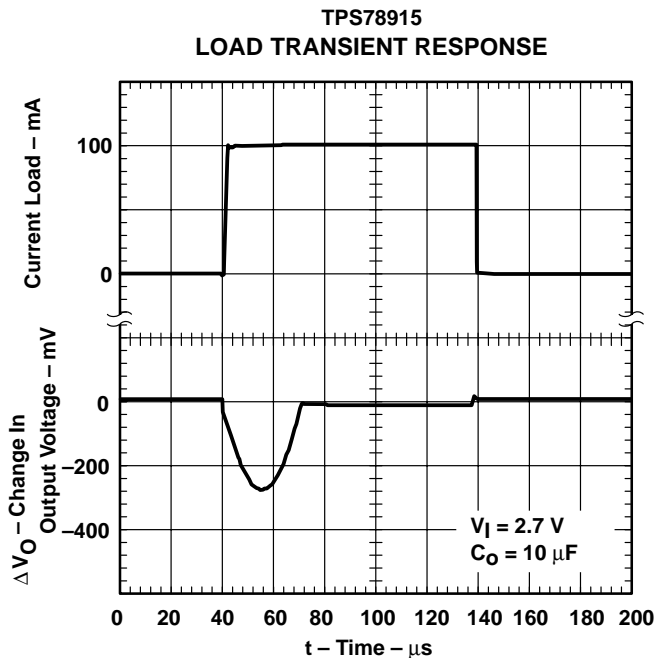

Figure 21

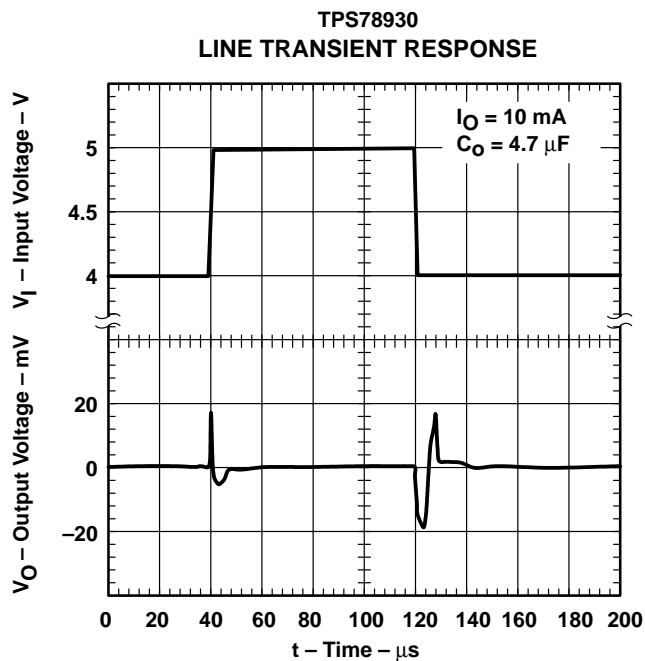

Figure 22

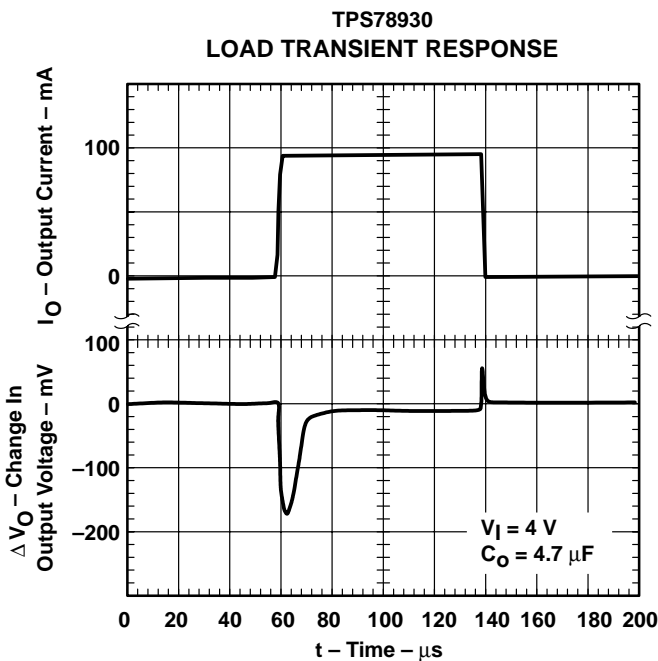

Figure 23

TPS78915, TPS78918, TPS78925, TPS78928, TPS78930  
 ULTRALOW-POWER LOW-NOISE 100-mA  
 LOW-DROPOUT LINEAR REGULATORS

SLVS300A – SEPTEMBER 2000 – REVISED MAY 2001

TYPICAL CHARACTERISTICS

TPS78930  
 TYPICAL REGIONS OF STABILITY  
 EQUIVALENT SERIES RESISTANCE (ESR)  
 VS  
 OUTPUT CURRENT

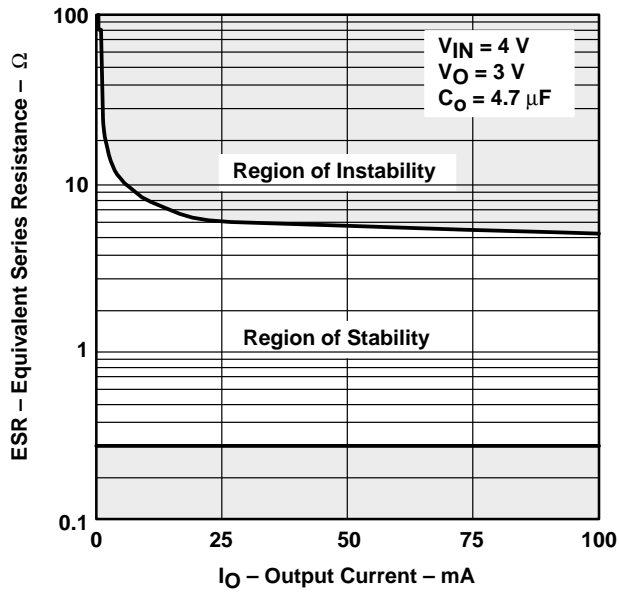

Figure 24

TPS78930  
 TYPICAL REGIONS OF STABILITY  
 EQUIVALENT SERIES RESISTANCE (ESR)  
 VS  
 OUTPUT CURRENT

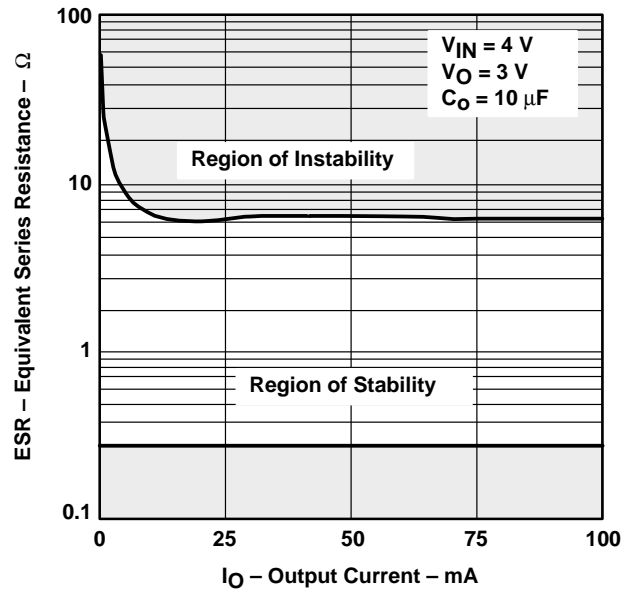

Figure 25

## APPLICATION INFORMATION

The TPS789xx family of low-dropout (LDO) regulators have been optimized for use in battery-operated equipment. They feature extremely low dropout voltages, low output noise, low quiescent current (17  $\mu\text{A}$  typically), and enable inputs to reduce supply currents to 1  $\mu\text{A}$  when the regulators are turned off.

A typical application circuit is shown in Figure 26.

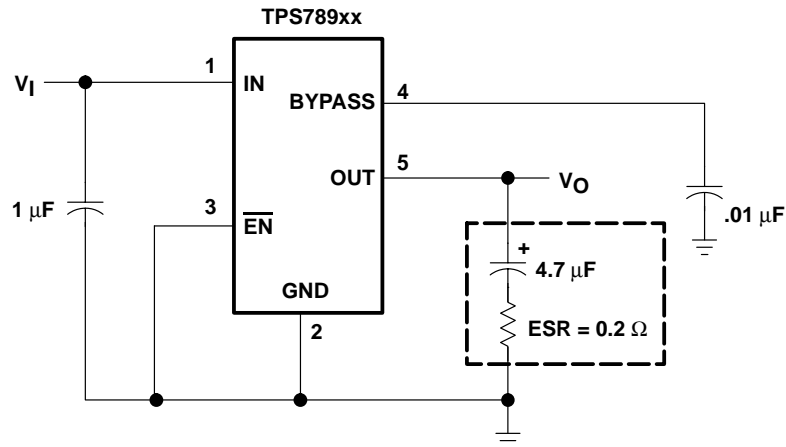

Figure 26. Typical Application Circuit

### external capacitor requirements

Although not required, a 0.047- $\mu\text{F}$  or larger ceramic input bypass capacitor, connected between IN and GND and located close to the TPS789xx, is recommended to improve transient response and noise rejection. A higher-value electrolytic input capacitor may be necessary if large, fast-rise-time load transients are anticipated and the device is located several inches from the power source.

Like all low dropout regulators, the TPS789xx requires an output capacitor connected between OUT and GND to stabilize the internal control loop. The minimum recommended capacitance is 4.7  $\mu\text{F}$ . The ESR (equivalent series resistance) of the capacitor should be between 0.2  $\Omega$  and 10  $\Omega$ . to ensure stability. Capacitor values larger than 4.7  $\mu\text{F}$  are acceptable, and allow the use of smaller ESR values. Capacitances less than 4.7  $\mu\text{F}$  are not recommended because they require careful selection of ESR to ensure stability. Solid tantalum electrolytic, aluminum electrolytic, and multilayer ceramic capacitors are all suitable, provided they meet the requirements described above. Most of the commercially available 4.7  $\mu\text{F}$  surface-mount solid tantalum capacitors, including devices from Sprague, Kemet, and Nichico, meet the ESR requirements stated above. Multilayer ceramic capacitors may have very small equivalent series resistances and may thus require the addition of a low value series resistor to ensure stability.

#### CAPACITOR SELECTION

PART NO.	MFR.	VALUE	MAX ESR†	SIZE (H × L × W)†
T494B475K016AS	KEMET	4.7 $\mu\text{F}$	1.5 $\Omega$	1.9 × 3.5 × 2.8
195D106x0016x2T	SPRAGUE	10 $\mu\text{F}$	1.5 $\Omega$	1.3 × 7.0 × 2.7
695D106x003562T	SPRAGUE	10 $\mu\text{F}$	1.3 $\Omega$	2.5 × 7.6 × 2.5
TPSC475K035R0600	AVX	4.7 $\mu\text{F}$	0.6 $\Omega$	2.6 × 6.0 × 3.2

† Size is in mm. The ESR maximum resistance is in ohms at 100 kHz and  $T_A = 25^\circ\text{C}$ . Contact the manufacturer for the minimum ESR values.

# TPS78915, TPS78918, TPS78925, TPS78928, TPS78930

## ULTRALOW-POWER LOW-NOISE 100-mA LOW-DROPOUT LINEAR REGULATORS

SLVS300A – SEPTEMBER 2000 – REVISED MAY 2001

---

### APPLICATION INFORMATION

#### external capacitor requirements (continued)

The external bypass capacitor, used in conjunction with an internal resistor to form a low-pass filter, should be a low ESR ceramic capacitor. For example, the TPS78930 exhibits only 56  $\mu\text{V}_{\text{RMS}}$  of output voltage noise using a 0.01  $\mu\text{F}$  ceramic bypass capacitor and a 10  $\mu\text{F}$  ceramic output capacitors. Note that the output will start up slower as the bypass capacitance increases due to the RC time constant at the bypass pin that is created by the internal 150 k $\Omega$  resistor and external capacitor.

#### power dissipation and junction temperature

Specified regulator operation is assured to a junction temperature of 125°C; the maximum junction temperature should be restricted to 125°C under normal operating conditions. This restriction limits the power dissipation the regulator can handle in any given application. To ensure the junction temperature is within acceptable limits, calculate the maximum allowable dissipation,  $P_{\text{D(max)}}$ , and the actual dissipation,  $P_{\text{D}}$ , which must be less than or equal to  $P_{\text{D(max)}}$ .

The maximum-power-dissipation limit is determined using the following equation:

$$P_{\text{D(max)}} = \frac{T_{\text{Jmax}} - T_{\text{A}}}{R_{\theta\text{JA}}}$$

Where:

$T_{\text{Jmax}}$  is the maximum allowable junction temperature.

$R_{\theta\text{JA}}$  is the thermal resistance junction-to-ambient for the package, see the dissipation rating table.

$T_{\text{A}}$  is the ambient temperature.

The regulator dissipation is calculated using:

$$P_{\text{D}} = (V_{\text{I}} - V_{\text{O}}) \times I_{\text{O}}$$

Power dissipation resulting from quiescent current is negligible. Excessive power dissipation will trigger the thermal protection circuit.

#### regulator protection

The TPS789xx PMOS-pass transistor has a built-in back diode that conducts reverse current when the input voltage drops below the output voltage (e.g., during power down). Current is conducted from the output to the input and is not internally limited. If extended reverse voltage operation is anticipated, external limiting might be appropriate.

The TPS789xx features internal current limiting and thermal protection. During normal operation, the TPS789xx limits output current to approximately 350 mA. When current limiting engages, the output voltage scales back linearly until the overcurrent condition ends. While current limiting is designed to prevent gross device failure, care should be taken not to exceed the power dissipation ratings of the package. If the temperature of the device exceeds approximately 165°C, thermal-protection circuitry shuts it down. Once the device has cooled down to below approximately 140°C, regulator operation resumes.



POST OFFICE BOX 655303 • DALLAS, TEXAS 75265



**PACKAGING INFORMATION**

Orderable Device	Status <sup>(1)</sup>	Package Type	Package Drawing	Pins	Package Qty	Eco Plan <sup>(2)</sup>	Lead/Ball Finish	MSL Peak Temp <sup>(3)</sup>
TPS78915DBVR	ACTIVE	SOT-23	DBV	5	3000	Green (RoHS & no Sb/Br)	CU NIPDAU	Level-1-260C-UNLIM
TPS78915DBVRG4	ACTIVE	SOT-23	DBV	5	3000	Green (RoHS & no Sb/Br)	CU NIPDAU	Level-1-260C-UNLIM
TPS78915DBVT	ACTIVE	SOT-23	DBV	5	250	Green (RoHS & no Sb/Br)	CU NIPDAU	Level-1-260C-UNLIM
TPS78915DBVTG4	ACTIVE	SOT-23	DBV	5	250	Green (RoHS & no Sb/Br)	CU NIPDAU	Level-1-260C-UNLIM
TPS78918DBVR	ACTIVE	SOT-23	DBV	5	3000	Green (RoHS & no Sb/Br)	CU NIPDAU	Level-1-260C-UNLIM
TPS78918DBVRG4	ACTIVE	SOT-23	DBV	5	3000	Green (RoHS & no Sb/Br)	CU NIPDAU	Level-1-260C-UNLIM
TPS78918DBVT	ACTIVE	SOT-23	DBV	5	250	Green (RoHS & no Sb/Br)	CU NIPDAU	Level-1-260C-UNLIM
TPS78918DBVTG4	ACTIVE	SOT-23	DBV	5	250	Green (RoHS & no Sb/Br)	CU NIPDAU	Level-1-260C-UNLIM
TPS78925DBVR	ACTIVE	SOT-23	DBV	5	3000	Green (RoHS & no Sb/Br)	CU NIPDAU	Level-1-260C-UNLIM
TPS78925DBVRG4	ACTIVE	SOT-23	DBV	5	3000	Green (RoHS & no Sb/Br)	CU NIPDAU	Level-1-260C-UNLIM
TPS78925DBVT	ACTIVE	SOT-23	DBV	5	250	Green (RoHS & no Sb/Br)	CU NIPDAU	Level-1-260C-UNLIM
TPS78925DBVTG4	ACTIVE	SOT-23	DBV	5	250	Green (RoHS & no Sb/Br)	CU NIPDAU	Level-1-260C-UNLIM
TPS78928DBVR	ACTIVE	SOT-23	DBV	5	3000	Green (RoHS & no Sb/Br)	CU NIPDAU	Level-1-260C-UNLIM
TPS78928DBVRG4	ACTIVE	SOT-23	DBV	5	3000	Green (RoHS & no Sb/Br)	CU NIPDAU	Level-1-260C-UNLIM
TPS78928DBVT	ACTIVE	SOT-23	DBV	5	250	Green (RoHS & no Sb/Br)	CU NIPDAU	Level-1-260C-UNLIM
TPS78928DBVTG4	ACTIVE	SOT-23	DBV	5	250	Green (RoHS & no Sb/Br)	CU NIPDAU	Level-1-260C-UNLIM
TPS78930DBVR	ACTIVE	SOT-23	DBV	5	3000	Green (RoHS & no Sb/Br)	CU NIPDAU	Level-1-260C-UNLIM
TPS78930DBVRG4	ACTIVE	SOT-23	DBV	5	3000	Green (RoHS & no Sb/Br)	CU NIPDAU	Level-1-260C-UNLIM
TPS78930DBVT	ACTIVE	SOT-23	DBV	5	250	Green (RoHS & no Sb/Br)	CU NIPDAU	Level-1-260C-UNLIM
TPS78930DBVTG4	ACTIVE	SOT-23	DBV	5	250	Green (RoHS & no Sb/Br)	CU NIPDAU	Level-1-260C-UNLIM

<sup>(1)</sup> The marketing status values are defined as follows:

**ACTIVE:** Product device recommended for new designs.

**LIFEBUY:** TI has announced that the device will be discontinued, and a lifetime-buy period is in effect.

**NRND:** Not recommended for new designs. Device is in production to support existing customers, but TI does not recommend using this part in a new design.

**PREVIEW:** Device has been announced but is not in production. Samples may or may not be available.

**OBsolete:** TI has discontinued the production of the device.

<sup>(2)</sup> Eco Plan - The planned eco-friendly classification: Pb-Free (RoHS), Pb-Free (RoHS Exempt), or Green (RoHS & no Sb/Br) - please check <http://www.ti.com/productcontent> for the latest availability information and additional product content details.

**TBD:** The Pb-Free/Green conversion plan has not been defined.

**Pb-Free (RoHS):** TI's terms "Lead-Free" or "Pb-Free" mean semiconductor products that are compatible with the current RoHS requirements for all 6 substances, including the requirement that lead not exceed 0.1% by weight in homogeneous materials. Where designed to be soldered at high temperatures, TI Pb-Free products are suitable for use in specified lead-free processes.

**Pb-Free (RoHS Exempt):** This component has a RoHS exemption for either 1) lead-based flip-chip solder bumps used between the die and package, or 2) lead-based die adhesive used between the die and leadframe. The component is otherwise considered Pb-Free (RoHS compatible) as defined above.

**Green (RoHS & no Sb/Br):** TI defines "Green" to mean Pb-Free (RoHS compatible), and free of Bromine (Br) and Antimony (Sb) based flame retardants (Br or Sb do not exceed 0.1% by weight in homogeneous material)

<sup>(3)</sup> MSL, Peak Temp. -- The Moisture Sensitivity Level rating according to the JEDEC industry standard classifications, and peak solder temperature.

**Important Information and Disclaimer:**The information provided on this page represents TI's knowledge and belief as of the date that it is provided. TI bases its knowledge and belief on information provided by third parties, and makes no representation or warranty as to the accuracy of such information. Efforts are underway to better integrate information from third parties. TI has taken and continues to take reasonable steps to provide representative and accurate information but may not have conducted destructive testing or chemical analysis on incoming materials and chemicals. TI and TI suppliers consider certain information to be proprietary, and thus CAS numbers and other limited information may not be available for release.

In no event shall TI's liability arising out of such information exceed the total purchase price of the TI part(s) at issue in this document sold by TI to Customer on an annual basis.

**TAPE AND REEL INFORMATION**

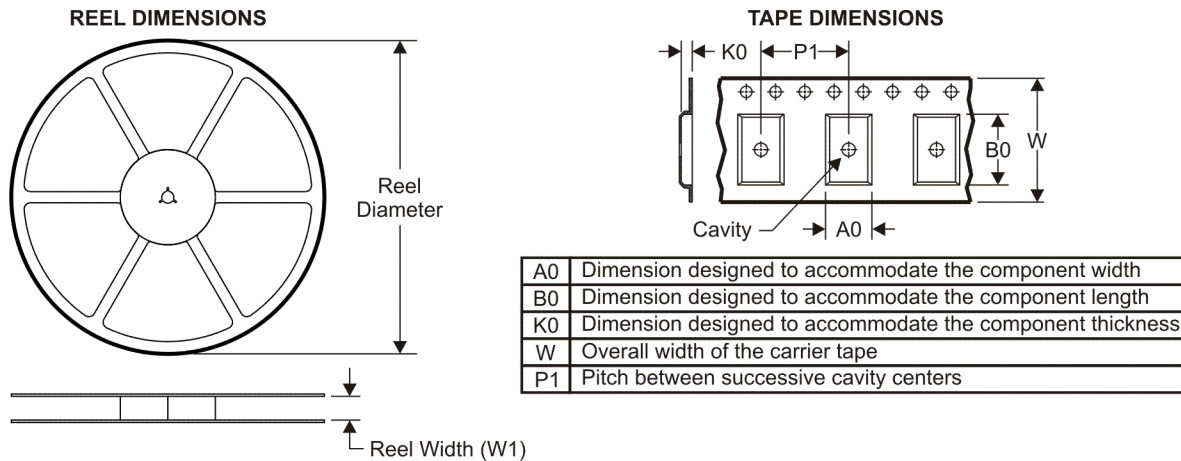

**QUADRANT ASSIGNMENTS FOR PIN 1 ORIENTATION IN TAPE**



\*All dimensions are nominal

Device	Package Type	Package Drawing	Pins	SPQ	Reel Diameter (mm)	Reel Width W1 (mm)	A0 (mm)	B0 (mm)	K0 (mm)	P1 (mm)	W (mm)	Pin1 Quadrant
TPS78915DBVR	SOT-23	DBV	5	3000	180.0	9.0	3.15	3.2	1.4	4.0	8.0	Q3
TPS78915DBVT	SOT-23	DBV	5	250	180.0	9.0	3.15	3.2	1.4	4.0	8.0	Q3
TPS78918DBVR	SOT-23	DBV	5	3000	180.0	9.0	3.15	3.2	1.4	4.0	8.0	Q3
TPS78918DBVT	SOT-23	DBV	5	250	180.0	9.0	3.15	3.2	1.4	4.0	8.0	Q3
TPS78925DBVR	SOT-23	DBV	5	3000	180.0	9.0	3.15	3.2	1.4	4.0	8.0	Q3
TPS78925DBVT	SOT-23	DBV	5	250	180.0	9.0	3.15	3.2	1.4	4.0	8.0	Q3
TPS78928DBVR	SOT-23	DBV	5	3000	180.0	9.0	3.15	3.2	1.4	4.0	8.0	Q3
TPS78928DBVT	SOT-23	DBV	5	250	180.0	9.0	3.15	3.2	1.4	4.0	8.0	Q3
TPS78930DBVR	SOT-23	DBV	5	3000	180.0	9.0	3.15	3.2	1.4	4.0	8.0	Q3
TPS78930DBVT	SOT-23	DBV	5	250	180.0	9.0	3.15	3.2	1.4	4.0	8.0	Q3

**TAPE AND REEL BOX DIMENSIONS**

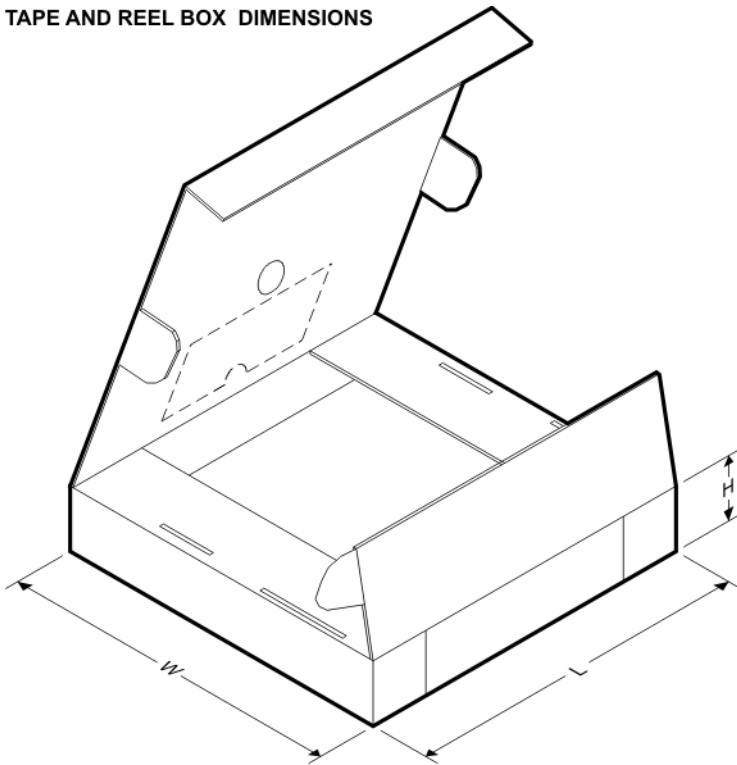

\*All dimensions are nominal

Device	Package Type	Package Drawing	Pins	SPQ	Length (mm)	Width (mm)	Height (mm)
TPS78915DBVR	SOT-23	DBV	5	3000	182.0	182.0	20.0
TPS78915DBVT	SOT-23	DBV	5	250	182.0	182.0	20.0
TPS78918DBVR	SOT-23	DBV	5	3000	182.0	182.0	20.0
TPS78918DBVT	SOT-23	DBV	5	250	182.0	182.0	20.0
TPS78925DBVR	SOT-23	DBV	5	3000	182.0	182.0	20.0
TPS78925DBVT	SOT-23	DBV	5	250	182.0	182.0	20.0
TPS78928DBVR	SOT-23	DBV	5	3000	182.0	182.0	20.0
TPS78928DBVT	SOT-23	DBV	5	250	182.0	182.0	20.0
TPS78930DBVR	SOT-23	DBV	5	3000	182.0	182.0	20.0
TPS78930DBVT	SOT-23	DBV	5	250	182.0	182.0	20.0

## IMPORTANT NOTICE

Texas Instruments Incorporated and its subsidiaries (TI) reserve the right to make corrections, modifications, enhancements, improvements, and other changes to its products and services at any time and to discontinue any product or service without notice. Customers should obtain the latest relevant information before placing orders and should verify that such information is current and complete. All products are sold subject to TI's terms and conditions of sale supplied at the time of order acknowledgment.

TI warrants performance of its hardware products to the specifications applicable at the time of sale in accordance with TI's standard warranty. Testing and other quality control techniques are used to the extent TI deems necessary to support this warranty. Except where mandated by government requirements, testing of all parameters of each product is not necessarily performed.

TI assumes no liability for applications assistance or customer product design. Customers are responsible for their products and applications using TI components. To minimize the risks associated with customer products and applications, customers should provide adequate design and operating safeguards.

TI does not warrant or represent that any license, either express or implied, is granted under any TI patent right, copyright, mask work right, or other TI intellectual property right relating to any combination, machine, or process in which TI products or services are used. Information published by TI regarding third-party products or services does not constitute a license from TI to use such products or services or a warranty or endorsement thereof. Use of such information may require a license from a third party under the patents or other intellectual property of the third party, or a license from TI under the patents or other intellectual property of TI.

Reproduction of TI information in TI data books or data sheets is permissible only if reproduction is without alteration and is accompanied by all associated warranties, conditions, limitations, and notices. Reproduction of this information with alteration is an unfair and deceptive business practice. TI is not responsible or liable for such altered documentation. Information of third parties may be subject to additional restrictions.

Resale of TI products or services with statements different from or beyond the parameters stated by TI for that product or service voids all express and any implied warranties for the associated TI product or service and is an unfair and deceptive business practice. TI is not responsible or liable for any such statements.

TI products are not authorized for use in safety-critical applications (such as life support) where a failure of the TI product would reasonably be expected to cause severe personal injury or death, unless officers of the parties have executed an agreement specifically governing such use. Buyers represent that they have all necessary expertise in the safety and regulatory ramifications of their applications, and acknowledge and agree that they are solely responsible for all legal, regulatory and safety-related requirements concerning their products and any use of TI products in such safety-critical applications, notwithstanding any applications-related information or support that may be provided by TI. Further, Buyers must fully indemnify TI and its representatives against any damages arising out of the use of TI products in such safety-critical applications.

TI products are neither designed nor intended for use in military/aerospace applications or environments unless the TI products are specifically designated by TI as military-grade or "enhanced plastic." Only products designated by TI as military-grade meet military specifications. Buyers acknowledge and agree that any such use of TI products which TI has not designated as military-grade is solely at the Buyer's risk, and that they are solely responsible for compliance with all legal and regulatory requirements in connection with such use.

TI products are neither designed nor intended for use in automotive applications or environments unless the specific TI products are designated by TI as compliant with ISO/TS 16949 requirements. Buyers acknowledge and agree that, if they use any non-designated products in automotive applications, TI will not be responsible for any failure to meet such requirements.

Following are URLs where you can obtain information on other Texas Instruments products and application solutions:

### Products

Amplifiers	<a href="http://amplifier.ti.com">amplifier.ti.com</a>
Data Converters	<a href="http://dataconverter.ti.com">dataconverter.ti.com</a>
DSP	<a href="http://dsp.ti.com">dsp.ti.com</a>
Clocks and Timers	<a href="http://www.ti.com/clocks">www.ti.com/clocks</a>
Interface	<a href="http://interface.ti.com">interface.ti.com</a>
Logic	<a href="http://logic.ti.com">logic.ti.com</a>
Power Mgmt	<a href="http://power.ti.com">power.ti.com</a>
Microcontrollers	<a href="http://microcontroller.ti.com">microcontroller.ti.com</a>
RFID	<a href="http://www.ti-rfid.com">www.ti-rfid.com</a>
RF/IF and ZigBee® Solutions	<a href="http://www.ti.com/lprf">www.ti.com/lprf</a>

### Applications

Audio	<a href="http://www.ti.com/audio">www.ti.com/audio</a>
Automotive	<a href="http://www.ti.com/automotive">www.ti.com/automotive</a>
Broadband	<a href="http://www.ti.com/broadband">www.ti.com/broadband</a>
Digital Control	<a href="http://www.ti.com/digitalcontrol">www.ti.com/digitalcontrol</a>
Medical	<a href="http://www.ti.com/medical">www.ti.com/medical</a>
Military	<a href="http://www.ti.com/military">www.ti.com/military</a>
Optical Networking	<a href="http://www.ti.com/opticalnetwork">www.ti.com/opticalnetwork</a>
Security	<a href="http://www.ti.com/security">www.ti.com/security</a>
Telephony	<a href="http://www.ti.com/telephony">www.ti.com/telephony</a>
Video & Imaging	<a href="http://www.ti.com/video">www.ti.com/video</a>
Wireless	<a href="http://www.ti.com/wireless">www.ti.com/wireless</a>

Mailing Address: Texas Instruments, Post Office Box 655303, Dallas, Texas 75265  
Copyright © 2008, Texas Instruments Incorporated

## Looking for pricing, stock, or lifecycle information?

Click below to explore more details on WIN SOURCE:

 [View TPS78930DBVT on WIN SOURCE](#)

 [Texas Instruments](#) Information

## Optimize Your Supply Chain with WIN SOURCE Solutions

-  Global Sourcing Solution
-  Obsolete Management
-  Cost Control Management
-  Shortage Management
-  Alternative Solution
-  Excess Inventory Management