



**THE DATASHEET OF  
VESD05A2-03F-GS08**



## 2-line ESD Protection Diode in SOT490

### Features

- Small SOT490 package
- Very low leakage current
- ESD protection to **IEC 61000-4-2 ± 30 kV (Air)**
- ESD protection to **IEC 61000-4-2 ± 20 kV (Contact)**
- Two line asymmetrical ESD-protection (**BiAs**)
- One line asymmetrical ESD-protection (**BiSy**)
- Lead (Pb)-free component
- Component in accordance to RoHS 2002/95/EC and WEEE 2002/96/EC

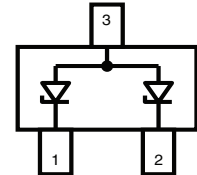

### Mechanical Data

**Case:** SOT490 (plastic package)

Lead free; non magnetic

**Molding Compound Flammability Rating:**

UL 94 V-0

**Terminals:** High temperature soldering guaranteed:  
260 °C/10 sec. at terminals

**Weight:** 2.5 mg

**Packaging Codes/Options:**

GS18 = 10 k per 13" reel (8 mm tape), 10 k/box

GS08 = 3 k per 7" reel (8 mm tape), 15 k/box

### Marking:

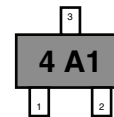

4 = date code (Example only)

A1 = Type Code for VESD05A2-03F

### Maximum Ratings and Thermal Characteristics

$T_A = 25\text{ °C}$  unless otherwise specified

Parameter	Symbol	Value	Unit
ESD Air Discharge per IEC 61000-4-2	$V_{ESD}$	± 30	kV
ESD Contact Discharge per IEC 61000-4-2	$V_{ESD}$	± 20	kV
Operating Temperature	$T_J$	- 40 to + 125	°C
Storage Temperature	$T_{STG}$	- 55 to + 150	°C

### Electrical Characteristics

$T_A = 25\text{ }^\circ\text{C}$  unless otherwise specified

#### BiAs-Mode (2-line Bidirectional Asymmetrical protection mode)

With the **VESD05A2-03F** two signal or data lines (L1, L2) can be clamped to ground. Due to the different clamping levels in forward and reverse direction the **VESD05A2-03F** clamping behavior is **Bidirectional** and **Asymmetric (BiAs)**.

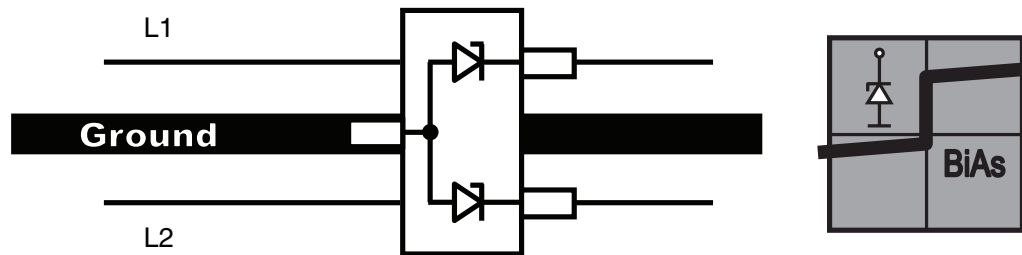

19742

Parameter	Test Conditions	Symbol	Min.	Typ.	Max.	Unit
Reverse Stand-Off Voltage	at max. reverse current	$V_{RWM}$	5			V
Max. Reverse current	at $V_R = 5\text{ V}$	$I_R$			0.1	$\mu\text{A}$
Max. Clamping voltage	at $I_{PP} = 3\text{ A}$ Acc. IEC 61000-4-5	$V_C$		8.9	11	V
Max. Peak pulse current	Acc. IEC 61000-4-5 See Fig. 1	$I_{PPM}$			3	A
Min. Reverse Breakdown Voltage	at $I_R = 1\text{ mA}$	$V_{BR}$	6.0	6.8	7.5	V
Capacitance	at $V_R = 0\text{ V}$ ; $f = 1\text{ MHz}$	$C_D$		20	23	pF
Forward voltage	at $I_F = 200\text{ mA}$ ; $t_p < 300\text{ }\mu\text{s}$	$V_F$		0.95	1.2	V
ESD-Clamping voltage (Overshoot)	at + 8 kV ESD-pulse acc. IEC 61000-4-2	$V_{C-ESD}$		+79		V
ESD-Clamping voltage (Undershoot)	at - 8 kV ESD-pulse acc. IEC 61000-4-2	$V_{C-ESD}$		-72		V

## BiSy-Mode (1-line Bidirectional Symmetrical protection mode)

### Single-Line Bidirectional Symmetrical ESD-Protection (BiSy)

With the **VESD05A2-03F** one signal or data line (L1) can be clamped to ground. Due to the same clamping levels in positive and negative direction the **VESD05A2-03F** voltage clamping behaviour is **Bidirectional** and **Symmetrical (BiSy)**.

In the BiSy-mode Pin no. 3 must not be connected. The load capacitance is about the half of the capacitance of the BiAs-mode.

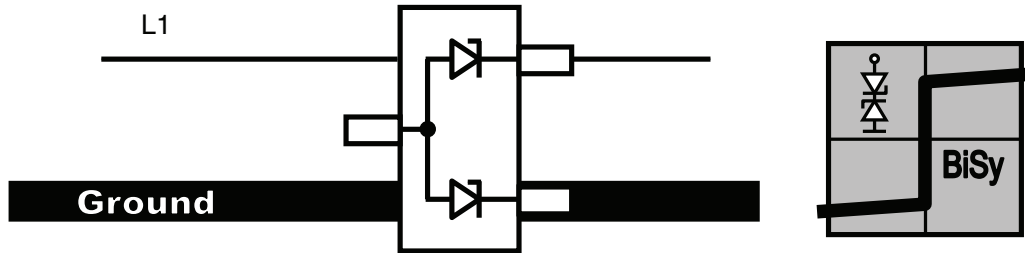

19741

Parameter	Test Conditions	Symbol	Min.	Typ.	Max.	Unit
Reverse Stand-Off Voltage	at max. reverse current	$V_{RWM}$	5.5			V
Max. Reverse current	at $V_R = 5.5$ V	$I_R$			0.1	$\mu$ A
Max. Clamping voltage	at $I_{PP} = 3$ A Acc. IEC 61000-4-5	$V_C$		10.6	12	V
Max. Peak pulse current	Acc. IEC 61000-4-5 See Fig. 1	$I_{PPM}$			3	A
Min. Reverse Breakdown Voltage	at $I_R = 1$ mA	$V_{BR}$	6.7	7.5	8.2	V
Capacitance	at $V_R = 0$ V; $f = 1$ MHz	$C_D$		10	12	pF
ESD-Clamping voltage	at $\pm 8$ kV ESD-pulse acc. IEC 61000-4-2	$V_{C-ESD}$		$\pm 100$		V

### Typical Characteristics

$T_A = 25\text{ }^\circ\text{C}$  unless otherwise specified

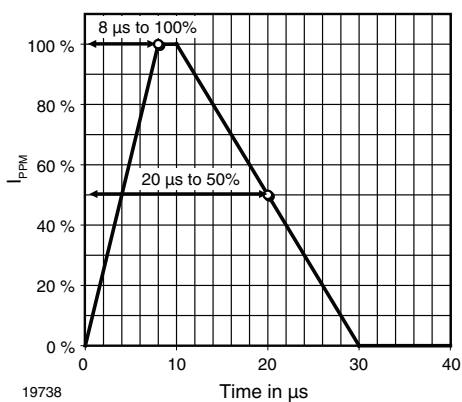

Figure 1. 8/20  $\mu\text{s}$  Peak Pulse Current wave form acc. IEC 61000-4-5

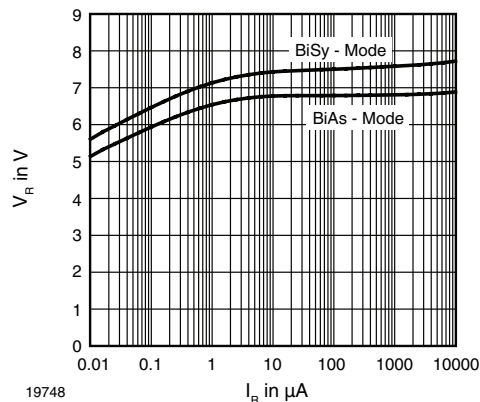

Figure 4. Typical Reverse Voltage  $V_R$  vs. Reverse Current  $I_R$

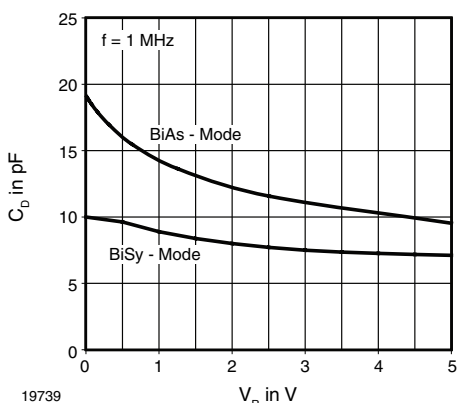

Figure 2. Typical Capacitance  $C_D$  vs. Reverse Voltage  $V_R$

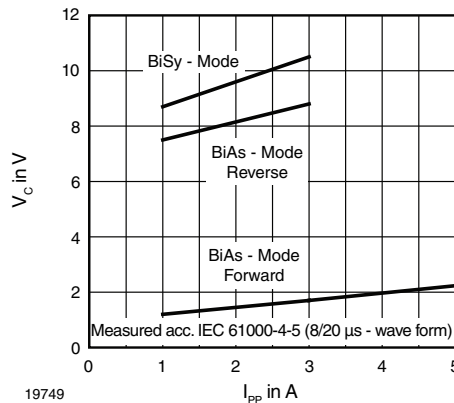

Figure 5. Typical Clamping Voltage vs. Peak Pulse Current  $I_{PP}$

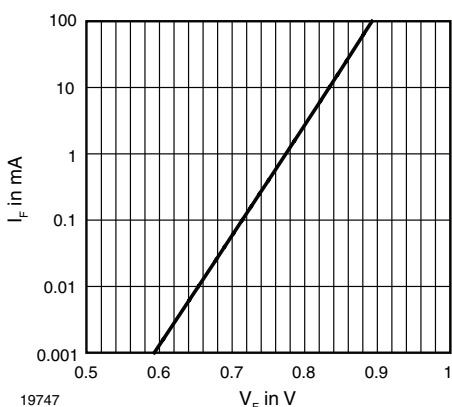

Figure 3. Typical Forward Current  $I_F$  vs. Forward Voltage  $V_F$

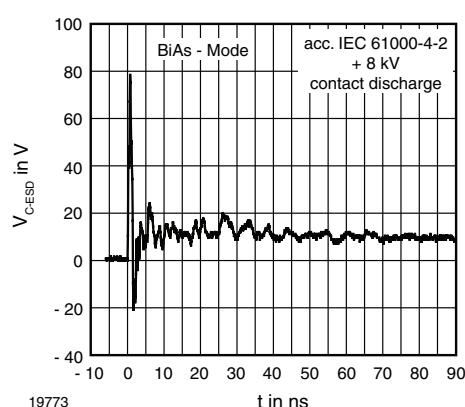

Figure 6. Typical Clamping performance at 8 kV contact discharge (Acc. IEC 61000-4-2)

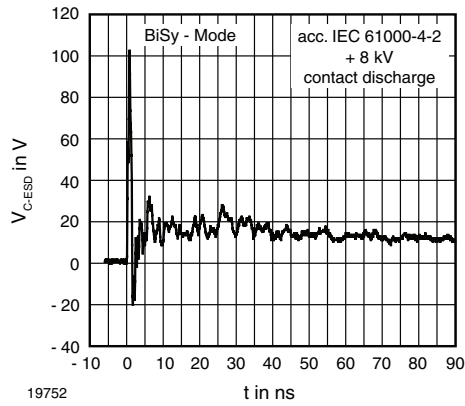

Figure 7. Typical Clamping performance at 8 kV contact discharge (Acc. IEC 61000-4-2)

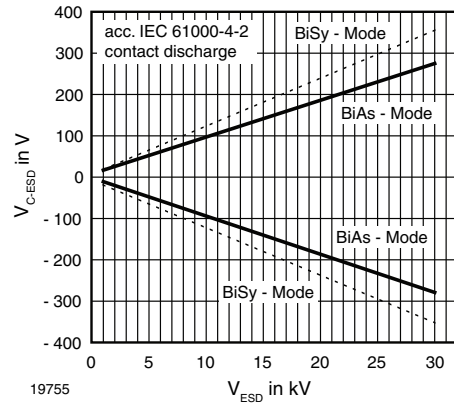

Figure 10. Typical clamping voltage at ± ESD contact discharge (Acc. IEC 61000-4-2)

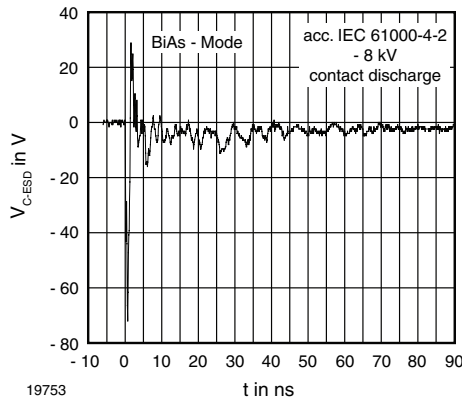

Figure 8. Typical Clamping performance at - 8 kV contact discharge (Acc. IEC 61000-4-2)

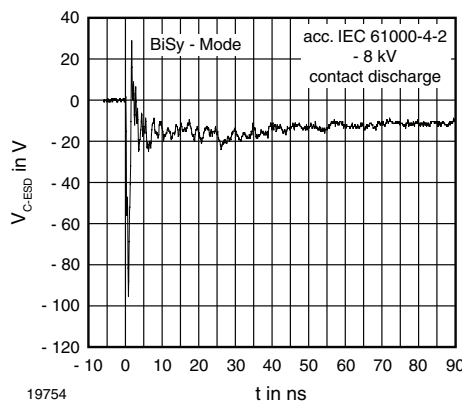
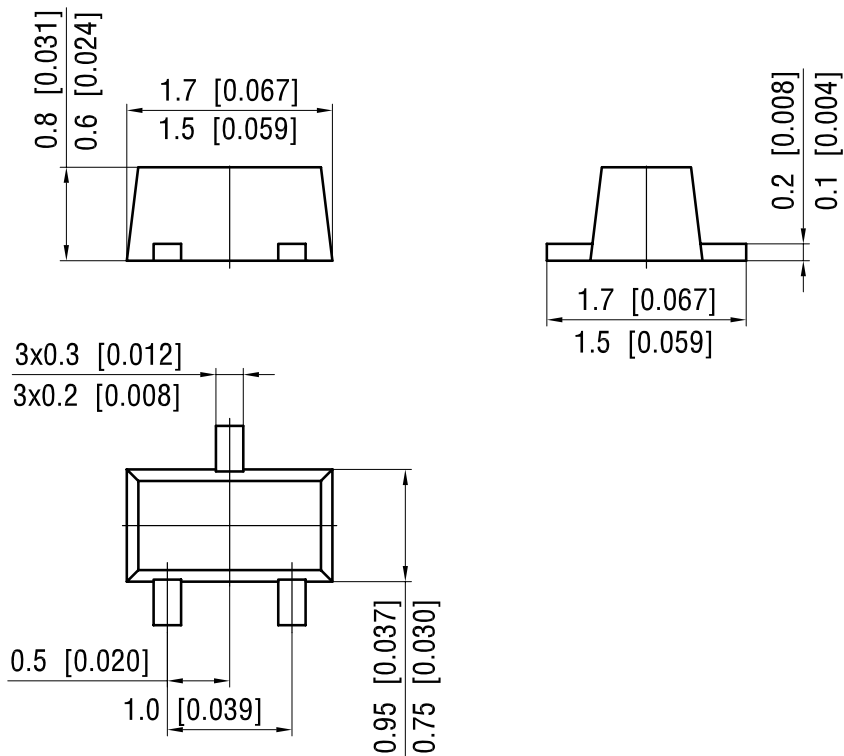
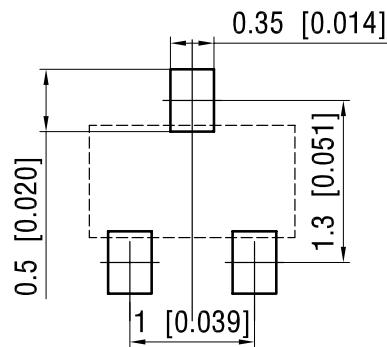

Figure 9. Typical Clamping performance at - 8 kV contact discharge (Acc. IEC 61000-4-2)

## Package Dimensions in mm (Inches) - SOT490



foot print recommendation:



19740

## Ozone Depleting Substances Policy Statement

It is the policy of Vishay Semiconductor GmbH to

1. Meet all present and future national and international statutory requirements.
2. Regularly and continuously improve the performance of our products, processes, distribution and operating systems with respect to their impact on the health and safety of our employees and the public, as well as their impact on the environment.

It is particular concern to control or eliminate releases of those substances into the atmosphere which are known as ozone depleting substances (ODSs).

The Montreal Protocol (1987) and its London Amendments (1990) intend to severely restrict the use of ODSs and forbid their use within the next ten years. Various national and international initiatives are pressing for an earlier ban on these substances.

Vishay Semiconductor GmbH has been able to use its policy of continuous improvements to eliminate the use of ODSs listed in the following documents.

1. Annex A, B and list of transitional substances of the Montreal Protocol and the London Amendments respectively
2. Class I and II ozone depleting substances in the Clean Air Act Amendments of 1990 by the Environmental Protection Agency (EPA) in the USA
3. Council Decision 88/540/EEC and 91/690/EEC Annex A, B and C (transitional substances) respectively.

Vishay Semiconductor GmbH can certify that our semiconductors are not manufactured with ozone depleting substances and do not contain such substances.

We reserve the right to make changes to improve technical design  
and may do so without further notice.

Parameters can vary in different applications. All operating parameters must be validated for each customer application by the customer. Should the buyer use Vishay Semiconductors products for any unintended or unauthorized application, the buyer shall indemnify Vishay Semiconductors against all claims, costs, damages, and expenses, arising out of, directly or indirectly, any claim of personal damage, injury or death associated with such unintended or unauthorized use.

Vishay Semiconductor GmbH, P.O.B. 3535, D-74025 Heilbronn, Germany



---

**Notice**

Specifications of the products displayed herein are subject to change without notice. Vishay Intertechnology, Inc., or anyone on its behalf, assumes no responsibility or liability for any errors or inaccuracies.

Information contained herein is intended to provide a product description only. No license, express or implied, by estoppel or otherwise, to any intellectual property rights is granted by this document. Except as provided in Vishay's terms and conditions of sale for such products, Vishay assumes no liability whatsoever, and disclaims any express or implied warranty, relating to sale and/or use of Vishay products including liability or warranties relating to fitness for a particular purpose, merchantability, or infringement of any patent, copyright, or other intellectual property right.

The products shown herein are not designed for use in medical, life-saving, or life-sustaining applications. Customers using or selling these products for use in such applications do so at their own risk and agree to fully indemnify Vishay for any damages resulting from such improper use or sale.

## Looking for pricing, stock, or lifecycle information?

Click below to explore more details on WIN SOURCE:

- ⊖ [View VESD05A2-03F-GS08 on WIN SOURCE](#)
- ⊖ [Vishay Information](#)

## Optimize Your Supply Chain with WIN SOURCE Solutions

- ✓ Global Sourcing Solution
- ✓ Obsolete Management
- ✓ Cost Control Management
- ✓ Shortage Management
- ✓ Alternative Solution
- ✓ Excess Inventory Management