



# THE DATASHEET OF AON6998



**General Description**

- Trench Power MOS Technology
- Low  $R_{DS(ON)}$
- Low Gate Charge
- High Current Capability
- RoHS and Halogen-Free Compliant

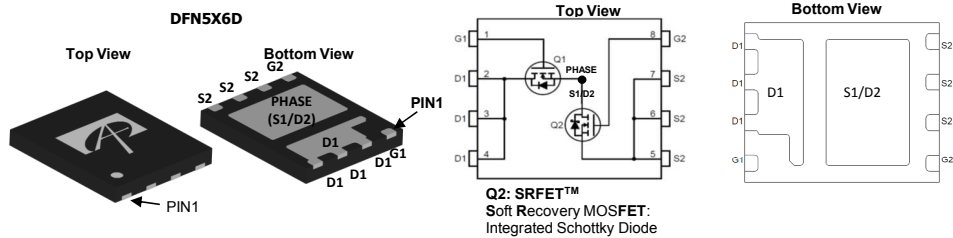
**Applications**

- DC/DC Converters in Computing
- Isolated DC/DC Converters in Telecom and Industrial

**Product Summary**

	<u>Q1</u>	<u>Q2</u>
$V_{DS}$	30V	30V
$I_D$ (at $V_{GS}=10V$ )	50A	82A
$R_{DS(ON)}$ (at $V_{GS}=10V$ )	< 5.2m $\Omega$	< 2.6m $\Omega$
$R_{DS(ON)}$ (at $V_{GS}=4.5V$ )	< 8.6m $\Omega$	< 2.99m $\Omega$

100% UIS Tested  
100% Rg Tested



Orderable Part Number	Package Type	Form	Minimum Order Quantity
AON6998	DFN 5x6D	Tape & Reel	3000

**Absolute Maximum Ratings  $T_A=25^\circ\text{C}$  unless otherwise noted**

Parameter	Symbol	Max Q1	Max Q2	Units	
Drain-Source Voltage	$V_{DS}$	30	30	V	
Gate-Source Voltage	$V_{GS}$	$\pm 20$	$\pm 12$	V	
Continuous Drain Current	$I_D$	$T_C=25^\circ\text{C}$	50	82	A
		$T_C=100^\circ\text{C}$	31	54	
Pulsed Drain Current <sup>C</sup>	$I_{DM}$	100	180		
Continuous Drain Current	$I_{DSM}$	$T_A=25^\circ\text{C}$	19	26	A
		$T_A=70^\circ\text{C}$	15	21	
Avalanche Current <sup>C</sup>	$I_{AS}$	38	72	A	
Avalanche energy $L=0.01\text{mH}$ <sup>C</sup>	$E_{AS}$	7	26	mJ	
$V_{DS}$ Spike	$V_{SPIKE}$	36	36	V	
Power Dissipation <sup>B</sup>	$P_D$	$T_C=25^\circ\text{C}$	21	31	W
		$T_C=100^\circ\text{C}$	8	13	
Power Dissipation <sup>A</sup>	$P_{DSM}$	$T_A=25^\circ\text{C}$	3.1	3.1	W
		$T_A=70^\circ\text{C}$	2	2	
Junction and Storage Temperature Range	$T_J, T_{STG}$	-55 to 150		$^\circ\text{C}$	

**Thermal Characteristics**

Parameter	Symbol	Typ Q1	Typ Q2	Max Q1	Max Q2	Units
Maximum Junction-to-Ambient <sup>A</sup>	$R_{\theta JA}$	30	30	40	40	$^\circ\text{C/W}$
Maximum Junction-to-Ambient <sup>A,D</sup>		Steady-State	50	50	65	65
Maximum Junction-to-Case	$R_{\theta JC}$	4.6	3.1	6	4	$^\circ\text{C/W}$

**Q1 Electrical Characteristics (T<sub>J</sub>=25°C unless otherwise noted)**

Symbol	Parameter	Conditions	Min	Typ	Max	Units
<b>STATIC PARAMETERS</b>						
BV <sub>DSS</sub>	Drain-Source Breakdown Voltage	ID=250μA, VGS=0V	30			V
I <sub>DSS</sub>	Zero Gate Voltage Drain Current	V <sub>DS</sub> =30V, V <sub>GS</sub> =0V T <sub>J</sub> =55°C			1 5	μA
I <sub>GSS</sub>	Gate-Body leakage current	V <sub>DS</sub> =0V, V <sub>GS</sub> =±20V			±100	nA
V <sub>GS(th)</sub>	Gate Threshold Voltage	V <sub>DS</sub> =V <sub>GS</sub> , I <sub>D</sub> =250μA	1.4	1.8	2.2	V
R <sub>DS(on)</sub>	Static Drain-Source On-Resistance	V <sub>GS</sub> =10V, I <sub>D</sub> =20A T <sub>J</sub> =125°C		4.3	5.2	mΩ
				6.3	7.6	
		V <sub>GS</sub> =4.5V, I <sub>D</sub> =20A		6.8	8.6	mΩ
g <sub>FS</sub>	Forward Transconductance	V <sub>DS</sub> =5V, I <sub>D</sub> =20A		67		S
V <sub>SD</sub>	Diode Forward Voltage	I <sub>S</sub> =1A, V <sub>GS</sub> =0V		0.71	1	V
I <sub>S</sub>	Maximum Body-Diode Continuous Current				20	A
<b>DYNAMIC PARAMETERS</b>						
C <sub>iss</sub>	Input Capacitance	V <sub>GS</sub> =0V, V <sub>DS</sub> =15V, f=1MHz		820		pF
C <sub>oss</sub>	Output Capacitance			340		pF
C <sub>riss</sub>	Reverse Transfer Capacitance			40		pF
R <sub>g</sub>	Gate resistance	f=1MHz	0.6	1.2	1.8	Ω
<b>SWITCHING PARAMETERS</b>						
Q <sub>g</sub> (10V)	Total Gate Charge	V <sub>GS</sub> =10V, V <sub>DS</sub> =15V, I <sub>D</sub> =20A		13		nC
Q <sub>g</sub> (4.5V)	Total Gate Charge			6.1		nC
Q <sub>gs</sub>	Gate Source Charge			2		nC
Q <sub>gd</sub>	Gate Drain Charge			2.4		nC
t <sub>D(on)</sub>	Turn-On DelayTime	V <sub>GS</sub> =10V, V <sub>DS</sub> =15V, R <sub>L</sub> =0.75Ω, R <sub>GEN</sub> =3Ω		6.5		ns
t <sub>r</sub>	Turn-On Rise Time			16.5		ns
t <sub>D(off)</sub>	Turn-Off DelayTime			17		ns
t <sub>f</sub>	Turn-Off Fall Time			2.5		ns
t <sub>rr</sub>	Body Diode Reverse Recovery Time	I <sub>F</sub> =20A, dI/dt=500A/μs		11		ns
Q <sub>rr</sub>	Body Diode Reverse Recovery Charge	I <sub>F</sub> =20A, dI/dt=500A/μs		19		nC

A. The value of R<sub>θJA</sub> is measured with the device mounted on 1in<sup>2</sup> FR-4 board with 2oz. Copper, in a still air environment with T<sub>A</sub>=25° C. The Power dissipation P<sub>DSM</sub> is based on R<sub>θJA</sub> ≤ 10s and the maximum allowed junction temperature of 150° C. The value in any given application depends on the user's specific board design.

B. The power dissipation P<sub>D</sub> is based on T<sub>J(MAX)</sub>=150° C, using junction-to-case thermal resistance, and is more useful in setting the upper dissipation limit for cases where additional heatsinking is used.

C. Single pulse width limited by junction temperature T<sub>J(MAX)</sub>=150° C.

D. The R<sub>θJA</sub> is the sum of the thermal impedance from junction to case R<sub>θJC</sub> and case to ambient.

E. The static characteristics in Figures 1 to 6 are obtained using <300μs pulses, duty cycle 0.5% max.

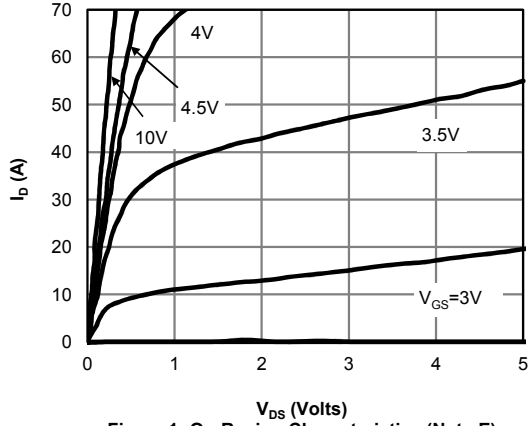
F. These curves are based on the junction-to-case thermal impedance which is measured with the device mounted to a large heatsink, assuming a maximum junction temperature of T<sub>J(MAX)</sub>=150° C. The SOA curve provides a single pulse rating.

G. The maximum current rating is package limited.

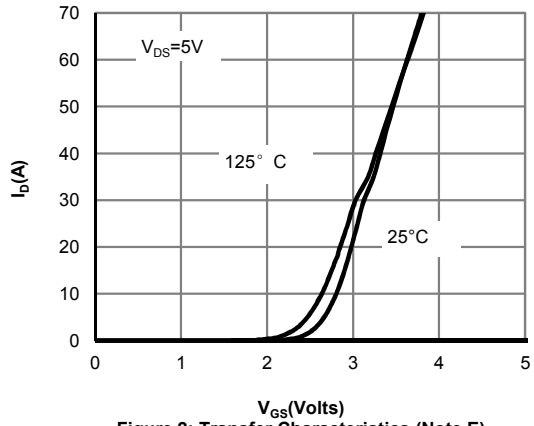
H. These tests are performed with the device mounted on 1 in<sup>2</sup> FR-4 board with 2oz. Copper, in a still air environment with T<sub>A</sub>=25° C.

THIS PRODUCT HAS BEEN DESIGNED AND QUALIFIED FOR THE CONSUMER MARKET. APPLICATIONS OR USES AS CRITICAL COMPONENTS IN LIFE SUPPORT DEVICES OR SYSTEMS ARE NOT AUTHORIZED. AOS DOES NOT ASSUME ANY LIABILITY ARISING OUT OF SUCH APPLICATIONS OR USES OF ITS PRODUCTS. AOS RESERVES THE RIGHT TO IMPROVE PRODUCT DESIGN, FUNCTIONS AND RELIABILITY WITHOUT NOTICE.

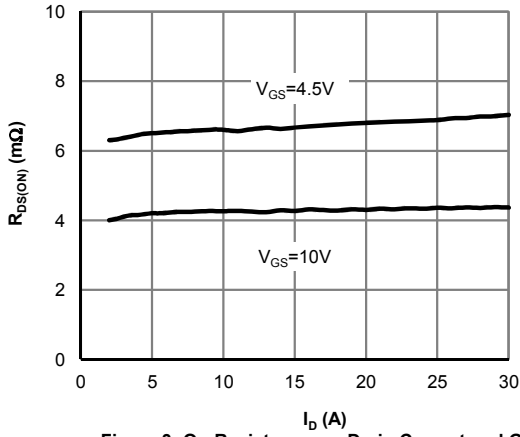
**TYPICAL ELECTRICAL AND THERMAL CHARACTERISTICS**



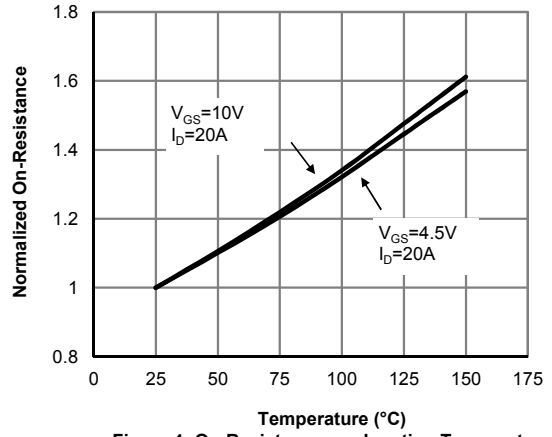
**Figure 1: On-Region Characteristics (Note E)**



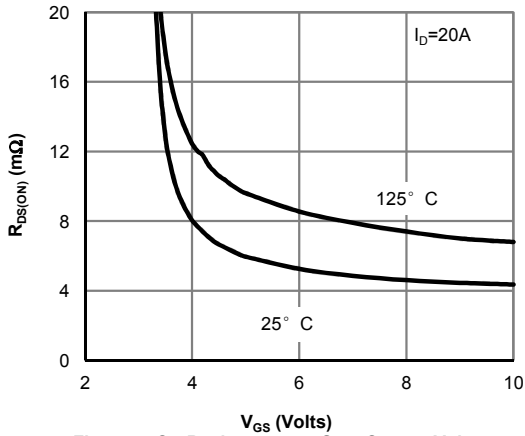
**Figure 2: Transfer Characteristics (Note E)**



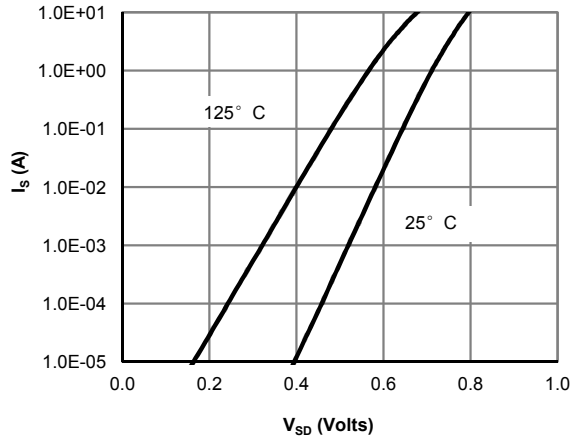
**Figure 3: On-Resistance vs. Drain Current and Gate Voltage (Note E)**



**Figure 4: On-Resistance vs. Junction Temperature (Note E)**



**Figure 5: On-Resistance vs. Gate-Source Voltage (Note E)**



**Figure 6: Body-Diode Characteristics (Note E)**

## TYPICAL ELECTRICAL AND THERMAL CHARACTERISTICS

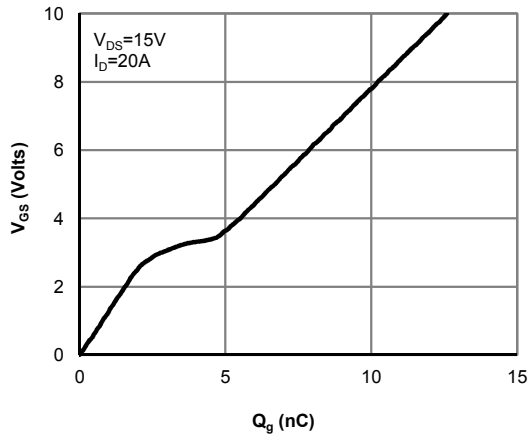


Figure 7: Gate-Charge Characteristics

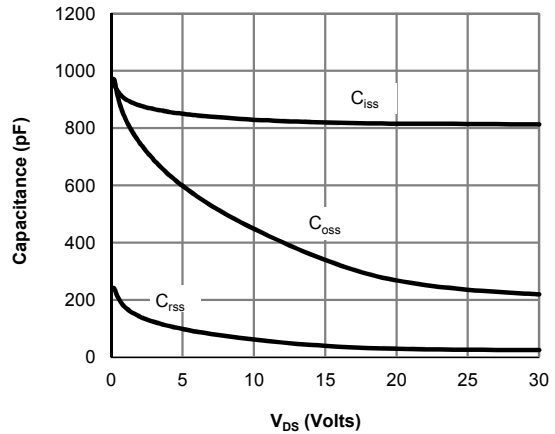


Figure 8: Capacitance Characteristics

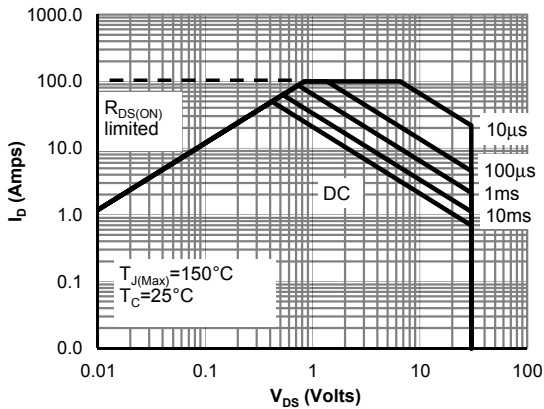


Figure 9: Maximum Forward Biased Safe Operating Area (Note F)

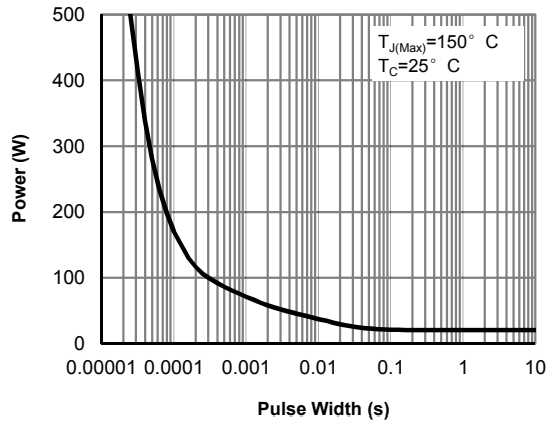


Figure 10: Single Pulse Power Rating Junction-to-Case (Note F)

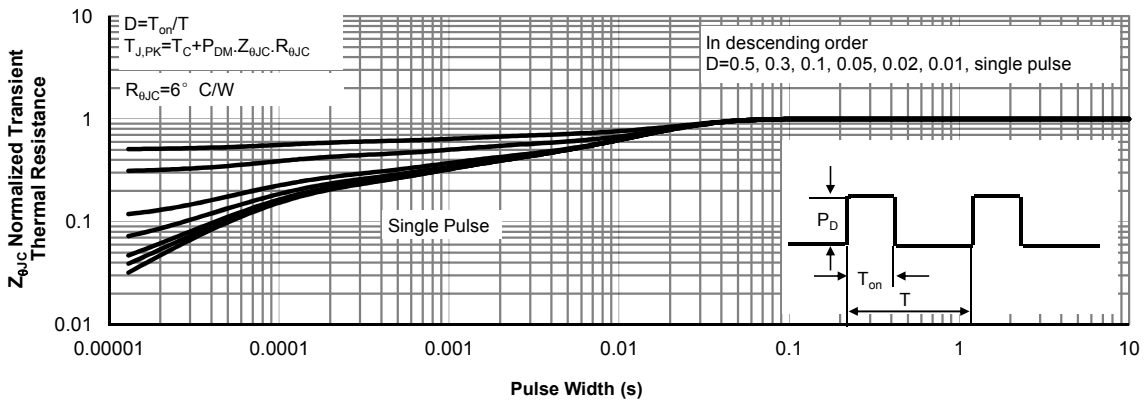


Figure 11: Normalized Maximum Transient Thermal Impedance (Note F)

**TYPICAL ELECTRICAL AND THERMAL CHARACTERISTICS**

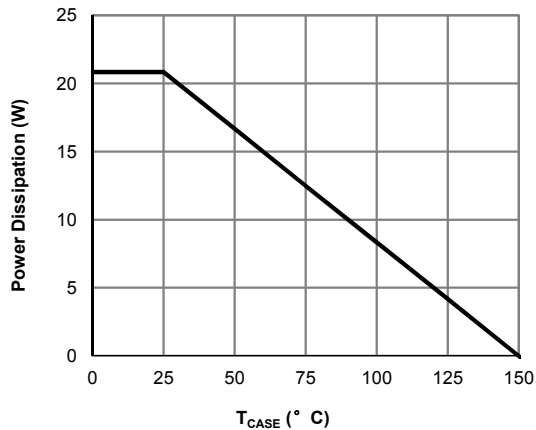


Figure 12: Power De-rating (Note F)

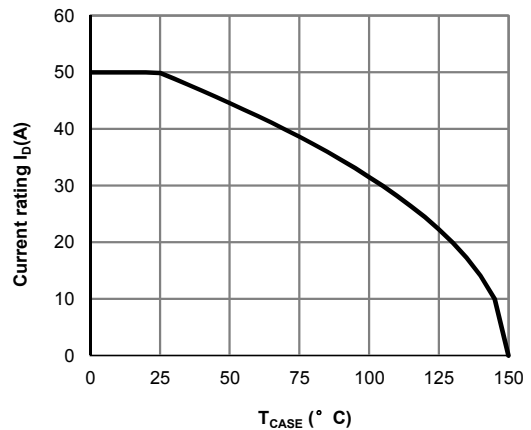


Figure 13: Current De-rating (Note F)

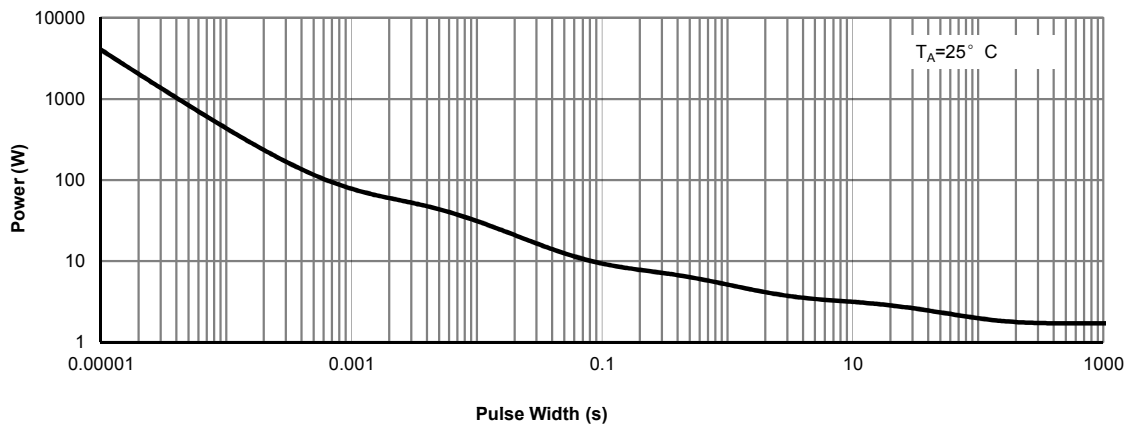


Figure 14: Single Pulse Power Rating Junction-to-Ambient (Note H)

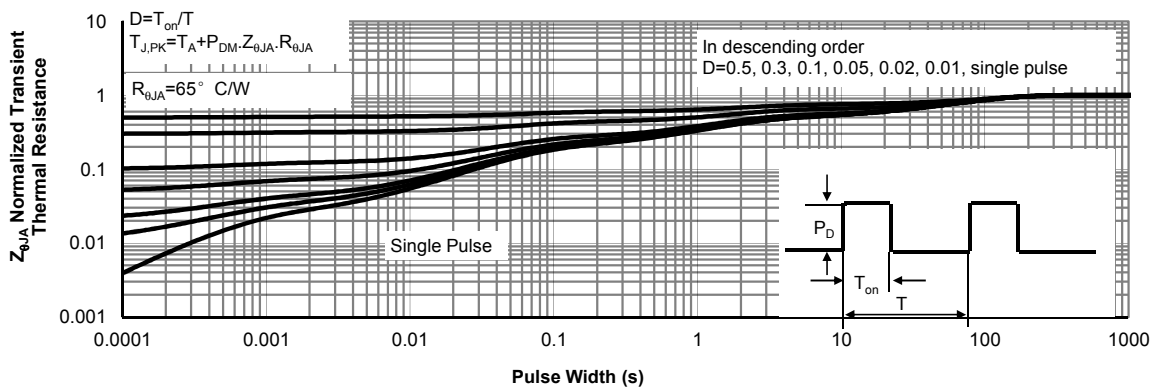


Figure 15: Normalized Maximum Transient Thermal Impedance (Note H)

## Q2 Electrical Characteristics (T<sub>J</sub>=25°C unless otherwise noted)

Symbol	Parameter	Conditions	Min	Typ	Max	Units
<b>STATIC PARAMETERS</b>						
BV <sub>DSS</sub>	Drain-Source Breakdown Voltage	ID=10mA, VGS=0V	30			V
I <sub>DSS</sub>	Zero Gate Voltage Drain Current	V <sub>DS</sub> =30V, V <sub>GS</sub> =0V T <sub>J</sub> =55°C			0.5 100	mA
I <sub>GSS</sub>	Gate-Body leakage current	V <sub>DS</sub> =0V, V <sub>GS</sub> =±12V			±100	nA
V <sub>GS(th)</sub>	Gate Threshold Voltage	V <sub>DS</sub> =V <sub>GS</sub> , I <sub>D</sub> =250μA	1	1.4	1.9	V
R <sub>DS(on)</sub>	Static Drain-Source On-Resistance	V <sub>GS</sub> =10V, I <sub>D</sub> =20A T <sub>J</sub> =125°C		2.1	2.6	mΩ
				3.1	3.8	
		V <sub>GS</sub> =4.5V, I <sub>D</sub> =20A		2.48	2.99	mΩ
g <sub>FS</sub>	Forward Transconductance	V <sub>DS</sub> =5V, I <sub>D</sub> =20A		167		S
V <sub>SD</sub>	Diode Forward Voltage	I <sub>S</sub> =1A, V <sub>GS</sub> =0V		0.5	0.7	V
I <sub>S</sub>	Maximum Body-Diode Continuous Current				30	A
<b>DYNAMIC PARAMETERS</b>						
C <sub>iss</sub>	Input Capacitance	V <sub>GS</sub> =0V, V <sub>DS</sub> =15V, f=1MHz		2150		pF
C <sub>oss</sub>	Output Capacitance			710		pF
C <sub>rss</sub>	Reverse Transfer Capacitance			70		pF
R <sub>g</sub>	Gate resistance	f=1MHz	0.9	1.8	2.7	Ω
<b>SWITCHING PARAMETERS</b>						
Q <sub>g</sub> (10V)	Total Gate Charge	V <sub>GS</sub> =10V, V <sub>DS</sub> =15V, I <sub>D</sub> =20A		37.5		nC
Q <sub>g</sub> (4.5V)	Total Gate Charge			17		nC
Q <sub>gs</sub>	Gate Source Charge			5		nC
Q <sub>gd</sub>	Gate Drain Charge			5		nC
t <sub>D(on)</sub>	Turn-On DelayTime	V <sub>GS</sub> =10V, V <sub>DS</sub> =15V, R <sub>L</sub> =0.75Ω, R <sub>GEN</sub> =3Ω		7		ns
t <sub>r</sub>	Turn-On Rise Time			3.5		ns
t <sub>D(off)</sub>	Turn-Off DelayTime			36		ns
t <sub>f</sub>	Turn-Off Fall Time			6		ns
t <sub>rr</sub>	Body Diode Reverse Recovery Time	I <sub>F</sub> =20A, dI/dt=500A/μs		15.5		ns
Q <sub>rr</sub>	Body Diode Reverse Recovery Charge	I <sub>F</sub> =20A, dI/dt=500A/μs		33		nC

A. The value of R<sub>θJA</sub> is measured with the device mounted on 1in<sup>2</sup> FR-4 board with 2oz. Copper, in a still air environment with T<sub>A</sub>=25° C. The Power dissipation P<sub>DSM</sub> is based on R<sub>θJA</sub> ≤ 10s and the maximum allowed junction temperature of 150° C. The value in any given application depends on the user's specific board design.

B. The power dissipation P<sub>D</sub> is based on T<sub>J(MAX)</sub>=150° C, using junction-to-case thermal resistance, and is more useful in setting the upper dissipation limit for cases where additional heatsinking is used.

C. Single pulse width limited by junction temperature T<sub>J(MAX)</sub>=150° C.

D. The R<sub>θJA</sub> is the sum of the thermal impedance from junction to case R<sub>θJC</sub> and case to ambient.

E. The static characteristics in Figures 1 to 6 are obtained using <300μs pulses, duty cycle 0.5% max.

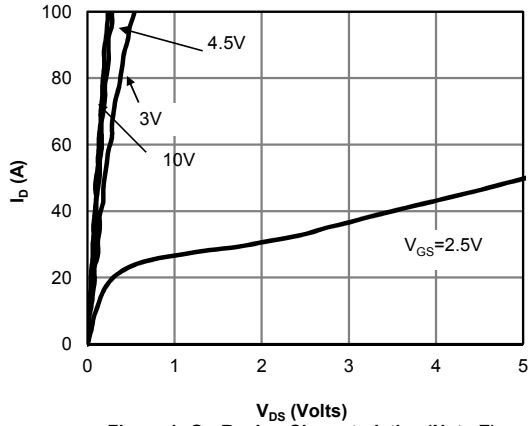
F. These curves are based on the junction-to-case thermal impedance which is measured with the device mounted to a large heatsink, assuming a maximum junction temperature of T<sub>J(MAX)</sub>=150° C. The SOA curve provides a single pulse rating.

G. The maximum current rating is package limited.

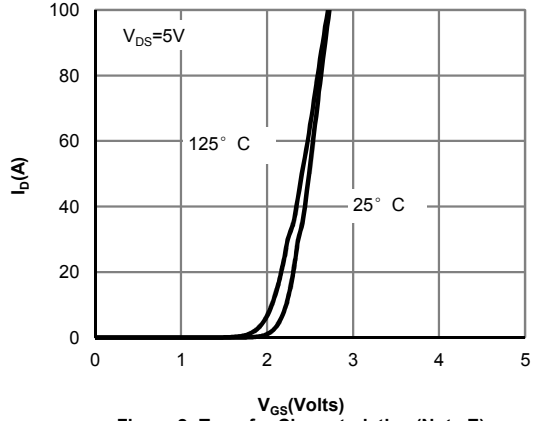
H. These tests are performed with the device mounted on 1 in<sup>2</sup> FR-4 board with 2oz. Copper, in a still air environment with T<sub>A</sub>=25° C.

THIS PRODUCT HAS BEEN DESIGNED AND QUALIFIED FOR THE CONSUMER MARKET. APPLICATIONS OR USES AS CRITICAL COMPONENTS IN LIFE SUPPORT DEVICES OR SYSTEMS ARE NOT AUTHORIZED. AOS DOES NOT ASSUME ANY LIABILITY ARISING OUT OF SUCH APPLICATIONS OR USES OF ITS PRODUCTS. AOS RESERVES THE RIGHT TO IMPROVE PRODUCT DESIGN, FUNCTIONS AND RELIABILITY WITHOUT NOTICE.

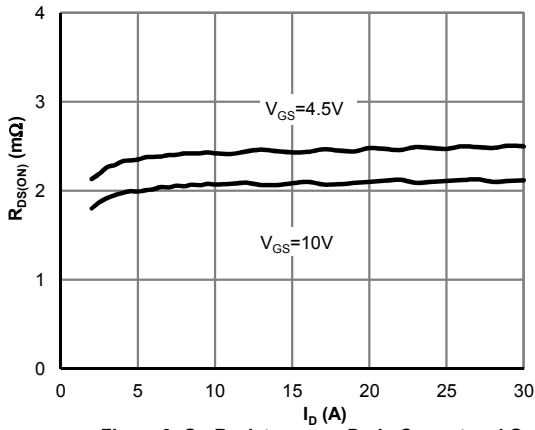
**TYPICAL ELECTRICAL AND THERMAL CHARACTERISTICS**



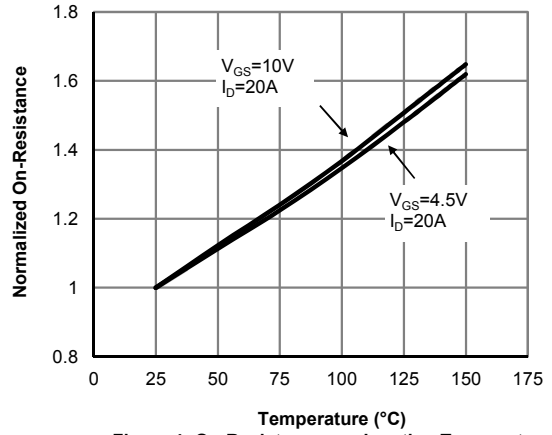
**Figure 1: On-Region Characteristics (Note E)**



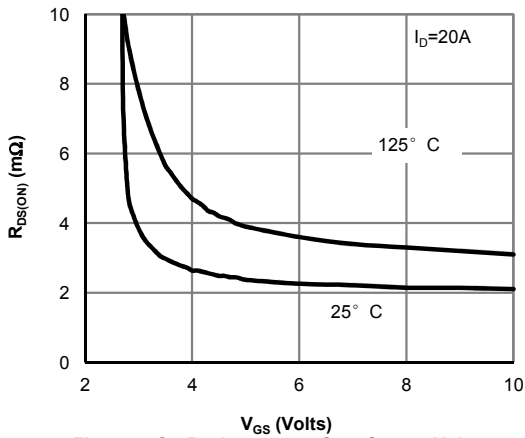
**Figure 2: Transfer Characteristics (Note E)**



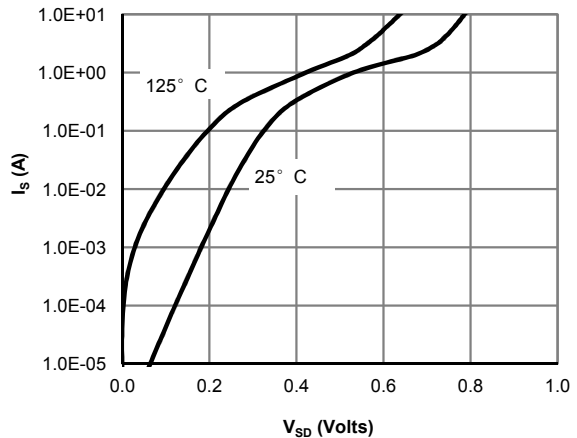
**Figure 3: On-Resistance vs. Drain Current and Gate Voltage (Note E)**



**Figure 4: On-Resistance vs. Junction Temperature (Note E)**

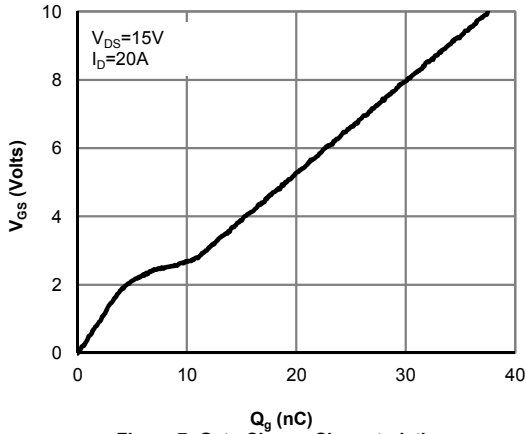


**Figure 5: On-Resistance vs. Gate-Source Voltage (Note E)**

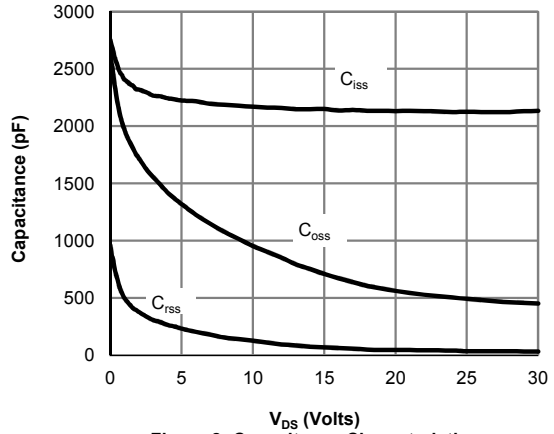


**Figure 6: Body-Diode Characteristics (Note E)**

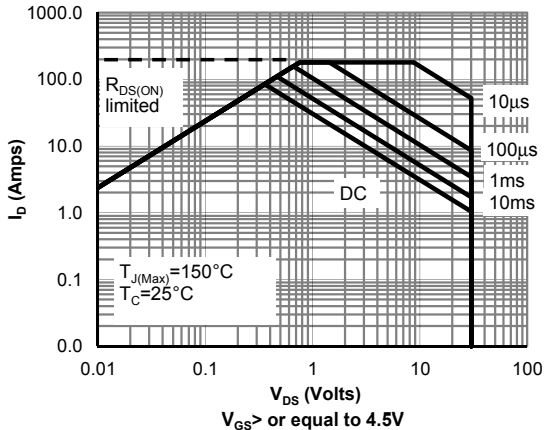
**TYPICAL ELECTRICAL AND THERMAL CHARACTERISTICS**



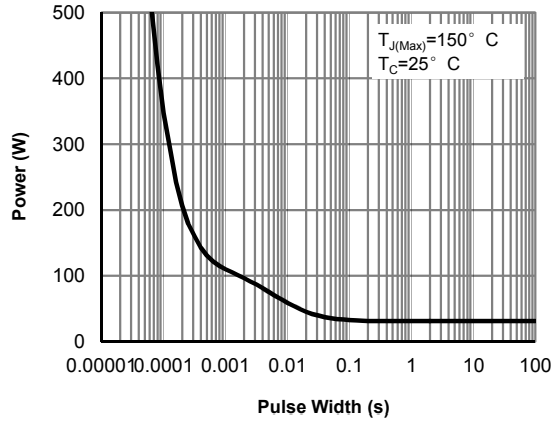
**Figure 7: Gate-Charge Characteristics**



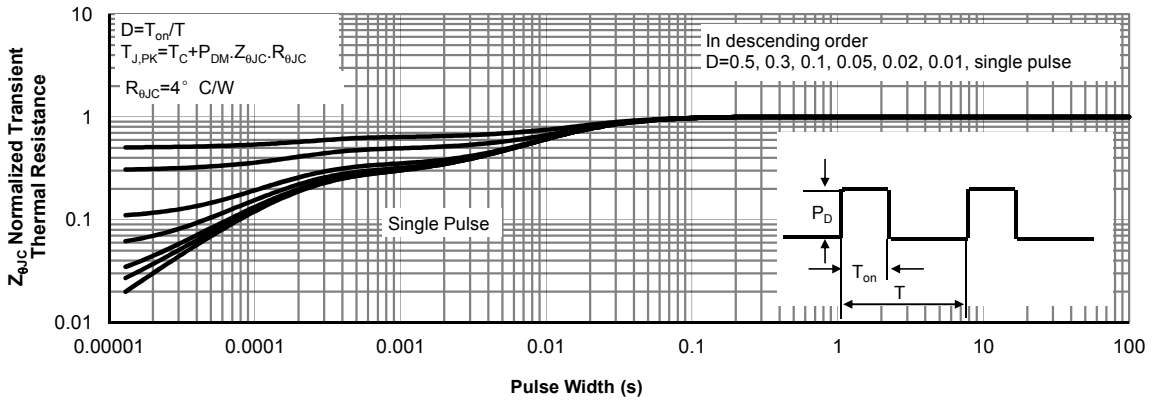
**Figure 8: Capacitance Characteristics**



**Figure 9: Maximum Forward Biased Safe Operating Area (Note F)**



**Figure 10: Single Pulse Power Rating Junction-to-Case (Note F)**



**Figure 11: Normalized Maximum Transient Thermal Impedance (Note F)**

**TYPICAL ELECTRICAL AND THERMAL CHARACTERISTICS**

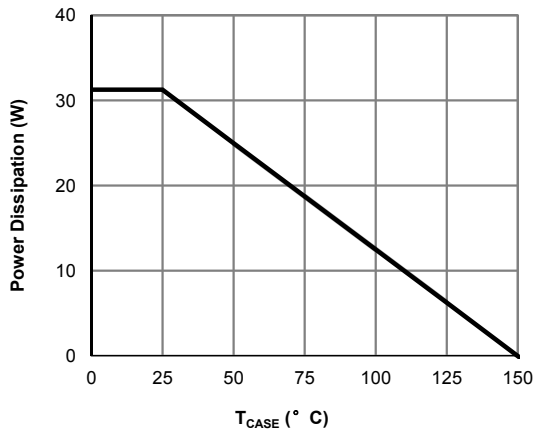


Figure 12: Power De-rating (Note F)

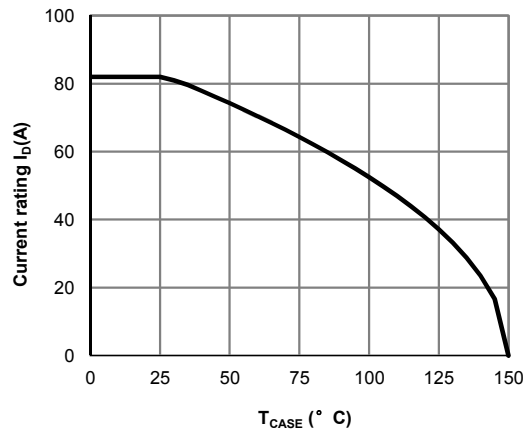


Figure 13: Current De-rating (Note F)

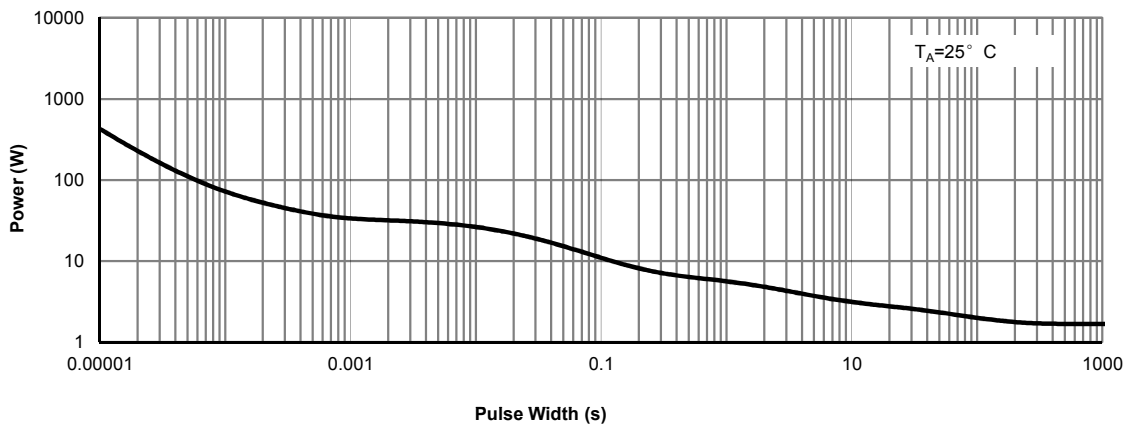


Figure 14: Single Pulse Power Rating Junction-to-Ambient (Note H)

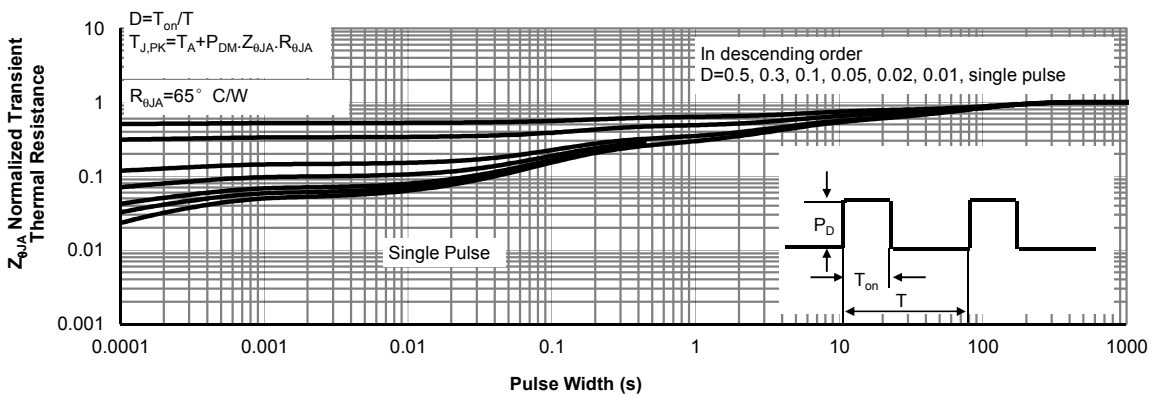
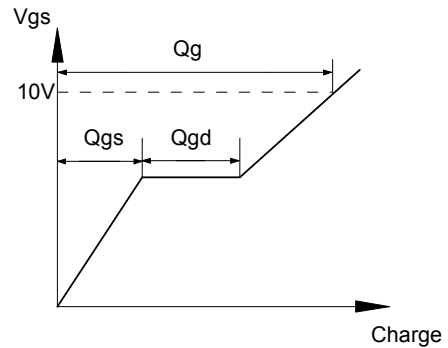
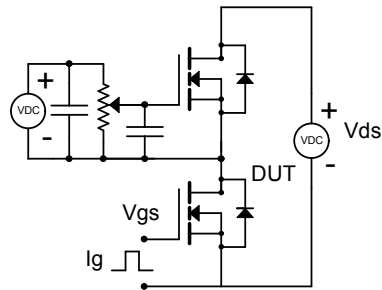
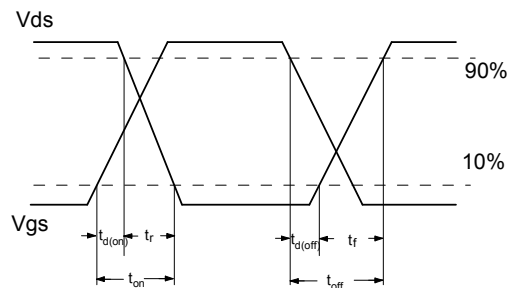
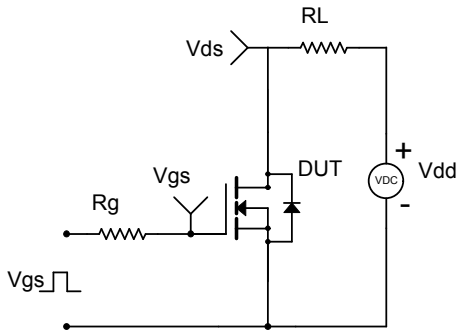


Figure 15: Normalized Maximum Transient Thermal Impedance (Note H)

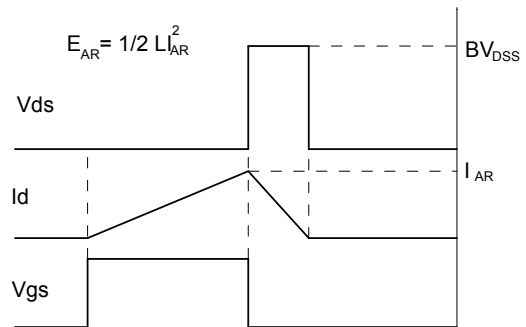
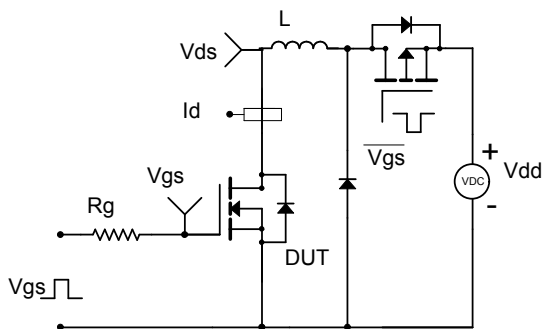
### Gate Charge Test Circuit & Waveform



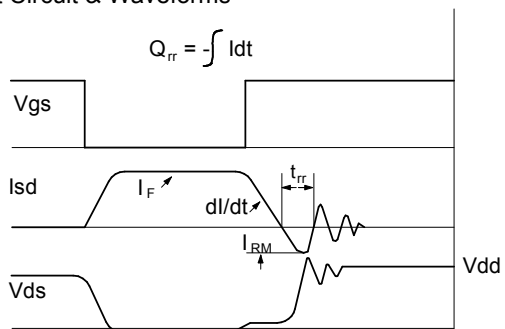
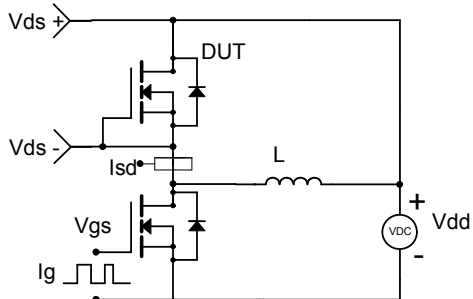
### Resistive Switching Test Circuit & Waveforms



### Unclamped Inductive Switching (UIS) Test Circuit & Waveforms



### Diode Recovery Test Circuit & Waveforms



## Looking for pricing, stock, or lifecycle information?

Click below to explore more details on WIN SOURCE:

- ⊖ [View AON6998 on WIN SOURCE](#)
- ⊖ [Alpha & Omega Semiconductor Inc. Information](#)

## Optimize Your Supply Chain with WIN SOURCE Solutions

- ✓ Global Sourcing Solution
- ✓ Obsolete Management
- ✓ Cost Control Management
- ✓ Shortage Management
- ✓ Alternative Solution
- ✓ Excess Inventory Management