



THE DATASHEET OF STFI20N65M5



N-channel 650 V, 0.160 Ω typ., 18 A MDmesh M5 Power MOSFETs in TO-220FP, I²PAKFP and TO-3PF packages

Datasheet - production data

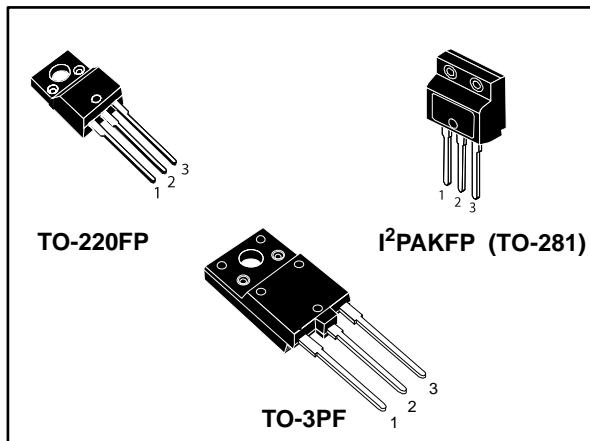
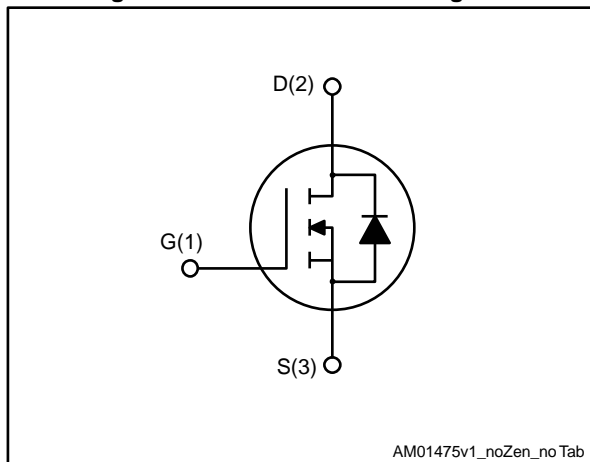

Figure 1: Internal schematic diagram



Features

Order code	V _{DS} @ T _{Jmax}	R _{DS(on)} max	I _D
STF20N65M5	710 V	0.190 Ω	18 A
STF120N65M5			
STFW20N65M5			

- Extremely low R_{DS(on)}
- Low gate charge and input capacitance
- Excellent switching performance
- 100% avalanche tested

Applications

- Switching applications

Description

These devices are N-channel Power MOSFET based on the MDmesh™ M5 innovative vertical process technology combined with the well-known PowerMESH™ horizontal layout. The resulting products offer extremely low on-resistance, making them particularly suitable for applications requiring high power and superior efficiency.

Table 1: Device summary

Order code	Marking	Package	Packaging
STF20N65M5	20N65M5	TO-220FP	Tube
STF120N65M5		I ² PAKFP (TO-281)	
STFW20N65M5		TO-3PF	

Contents

1	Electrical ratings	3
2	Electrical characteristics	4
	2.1 Electrical characteristics (curve).....	6
3	Test circuits	9
4	Package information	10
	4.1 TO-220FP package information	11
	4.2 I ² PAKFP (TO-281) package information	13
	4.3 TO-3PF package information	15
5	Revision history	17

1 Electrical ratings

Table 2: Absolute maximum ratings

Symbol	Parameter	Value		Unit
		TO-220FP, I ² PAKFP	TO-3PF	
V _{GS}	Gate- source voltage	±25		V
I _D	Drain current (continuous) at T _C = 25 °C	18 ⁽¹⁾		A
I _D	Drain current (continuous) at T _C = 100 °C	11.3 ⁽¹⁾		A
I _{DM} ⁽²⁾	Drain current (pulsed)	36 ⁽¹⁾		A
P _{TOT}	Total dissipation at T _C = 25 °C	30	48	W
dv/dt ⁽³⁾	Peak diode recovery voltage slope	15		V/ns
V _{ISO} ⁽⁴⁾	Insulation withstand voltage (RMS) from all three leads to external heat sink (t = 1 s; T _C = 25 °C)	2500	3500	V
T _{stg}	Storage temperature range	- 55 to 150		°C
T _j	Operating junction temperature range			

Notes:

(1)Limited by maximum junction temperature.

(2)Pulse width limited by safe operating area

(3) $I_{SD} \leq 18$ A, $di/dt = 400$ A/ μ s, $V_{DS(peak)} < V_{(BR)DSS}$, $V_{DD} = 400$ V

(4) $V_{DS} \leq 520$ V

Table 3: Thermal data

Symbol	Parameter	Value		Unit
		TO-220FP, I ² PAKFP	TO-3PF	
R _{thj-case}	Thermal resistance junction-case	4.17	2.6	°C/W
R _{thj-amb}	Thermal resistance junction-ambient	62.5	50	°C/W

Table 4: Avalanche characteristics

Symbol	Parameter	Value	Unit
I _{AR}	Avalanche current, repetitive or not repetitive (pulse width limited by T _{jmax})	4	°C/W
E _{AS}	Single pulse avalanche energy (starting T _J = 25 °C, I _D = I _{AR} , V _{DD} = 50 V)	270	mJ

2 Electrical characteristics

($T_C = 25\text{ °C}$ unless otherwise specified)

Table 5: On /off states

Symbol	Parameter	Test conditions	Min.	Typ.	Max.	Unit
$V_{(BR)DSS}$	Drain-source breakdown voltage	$V_{GS} = 0, I_D = 1\text{ mA}$	650			V
I_{DSS}	Zero gate voltage drain current	$V_{GS} = 0, V_{DS} = 650\text{ V}$			1	μA
		$V_{GS} = 0, V_{DS} = 650\text{ V}, T_C = 125\text{ °C}$ ⁽¹⁾			100	μA
I_{GSS}	Gate-body leakage current	$V_{DS} = 0, V_{GS} = \pm 25\text{ V}$			± 100	nA
$V_{GS(th)}$	Gate threshold voltage	$V_{DS} = V_{GS}, I_D = 250\text{ }\mu\text{A}$	3	4	5	V
$R_{DS(on)}$	Static drain-source on-resistance	$V_{GS} = 10\text{ V}, I_D = 9\text{ A}$		0.160	0.190	Ω

Notes:

⁽¹⁾Defined by design, not subject to production test

Table 6: Dynamic

Symbol	Parameter	Test conditions	Min.	Typ.	Max.	Unit
C_{iss}	Input capacitance	$V_{GS} = 0, V_{DS} = 100\text{ V}, f = 1\text{ MHz}$	-	1434	-	pF
C_{oss}	Output capacitance		-	38	-	pF
C_{rss}	Reverse transfer capacitance		-	3.7	-	pF
$C_{o(tr)}$ ⁽¹⁾	Equivalent capacitance time related	$V_{GS} = 0, V_{DS} = 0\text{ to }520\text{ V}$	-	118	-	pF
$C_{o(er)}$ ⁽²⁾	Equivalent capacitance energy related		-	35	-	pF
R_G	Intrinsic gate resistance	$f = 1\text{ MHz}, I_D = 0\text{ A}$	-	3.5	-	Ω
Q_g	Total gate charge	$V_{DD} = 520\text{ V}, I_D = 9\text{ A}, V_{GS} = 0\text{ to }10\text{ V}$ (see Figure 18: "Test circuit for gate charge behavior")	-	36	-	nC
Q_{gs}	Gate-source charge		-	7.5	-	nC
Q_{gd}	Gate-drain charge		-	18	-	nC

Notes:

⁽¹⁾ $C_{o(tr)}$ is a constant capacitance value that gives the same charging time as C_{oss} while V_{DS} is rising from 0 to 80% V_{DSS} .

⁽²⁾ $C_{o(er)}$ is a constant capacitance value that gives the same stored energy as C_{oss} while V_{DS} is rising from 0 to 80% V_{DSS} .

Table 7: Switching times

Symbol	Parameter	Test conditions	Min.	Typ.	Max.	Unit
$t_{d(V)}$	Voltage delay time	$V_{DD} = 400 \text{ V}$, $I_D = 12 \text{ A}$, $R_G = 4.7 \text{ } \Omega$, $V_{GS} = 10 \text{ V}$ (see Figure 19: "Test circuit for inductive load switching and diode recovery times" and Figure 22: "Switching time waveform")	-	43	-	ns
$t_{r(V)}$	Voltage rise time		-	7.5	-	ns
$t_{f(i)}$	Current fall time		-	7.5	-	ns
$t_{c(off)}$	Crossing time		-	11.5	-	ns

Table 8: Source drain diode

Symbol	Parameter	Test conditions	Min.	Typ.	Max.	Unit
I_{SD}	Source-drain current		-		18	A
$I_{SDM}^{(1)}$	Source-drain current (pulsed)		-		36	A
$V_{SD}^{(2)}$	Forward on voltage	$I_{SD} = 18 \text{ A}$, $V_{GS} = 0$	-		1.5	V
t_{rr}	Reverse recovery time	$I_{SD} = 18 \text{ A}$, $di/dt = 100 \text{ A}/\mu\text{s}$ $V_{DD} = 100 \text{ V}$ (see Figure 19: "Test circuit for inductive load switching and diode recovery times")	-	288		ns
Q_{rr}	Reverse recovery charge		-	4		μC
I_{RRM}	Reverse recovery current		-	27		A
t_{rr}	Reverse recovery time	$I_{SD} = 18 \text{ A}$, $di/dt = 100 \text{ A}/\mu\text{s}$ $V_{DD} = 100 \text{ V}$, $T_j = 150 \text{ }^\circ\text{C}$ (see Figure 19: "Test circuit for inductive load switching and diode recovery times")	-	342		ns
Q_{rr}	Reverse recovery charge		-	4.7		μC
I_{RRM}	Reverse recovery current		-	28		A

Notes:

(1)Pulse width limited by safe operating area

(2)Pulsed: pulse duration = 300 μs , duty cycle 1.5%

2.1 Electrical characteristics (curve)

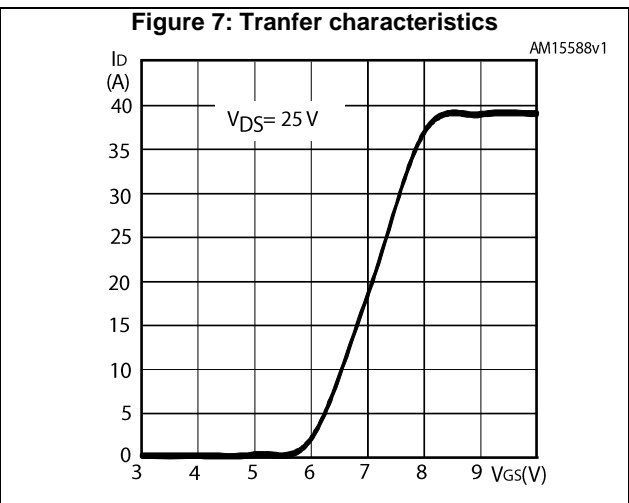
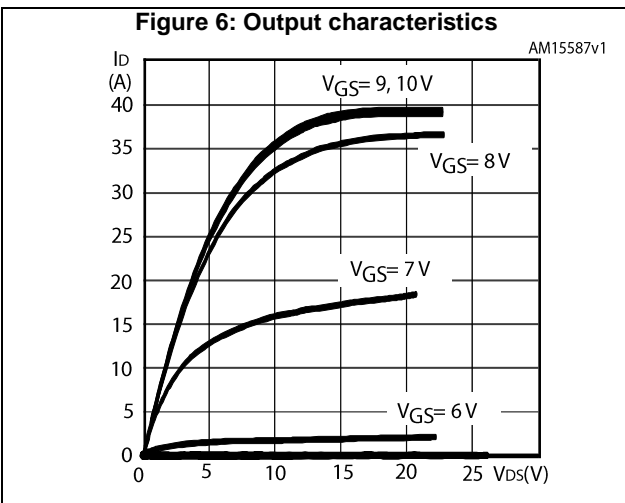
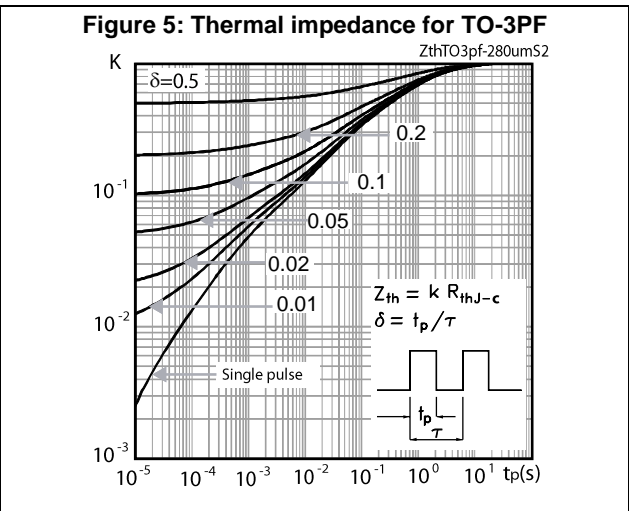
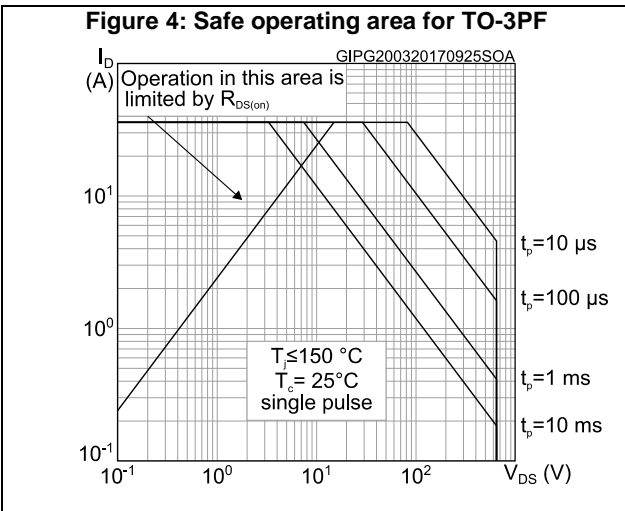
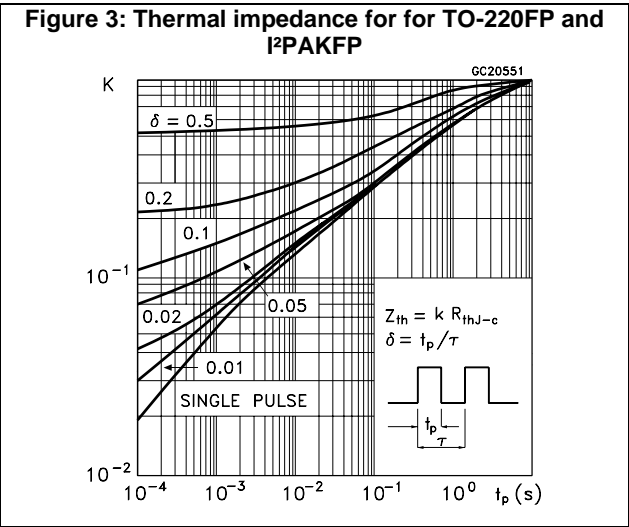
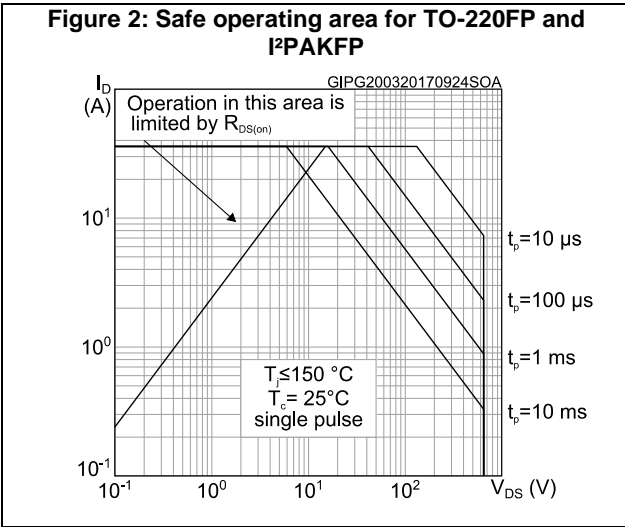

Figure 8: Gate charge vs gate-source voltage

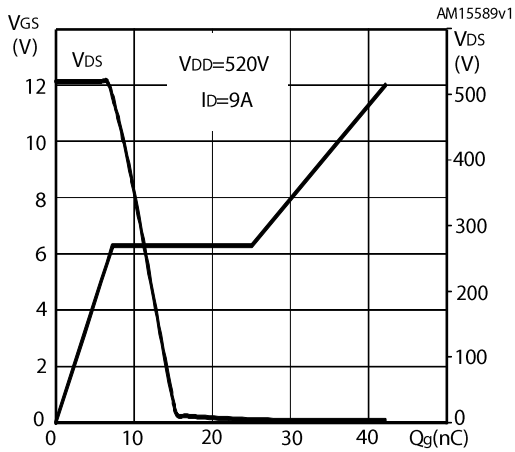

Figure 9: Static drain-source on-resistance

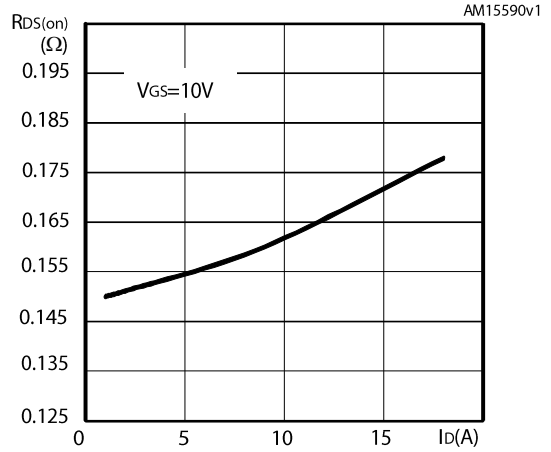

Figure 10: Capacitance variations

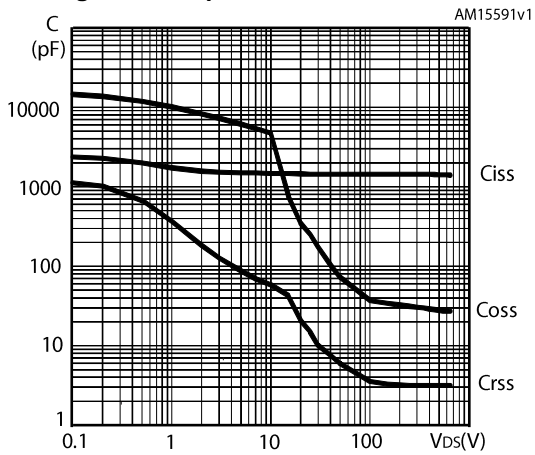

Figure 11: Output capacitance stored energy

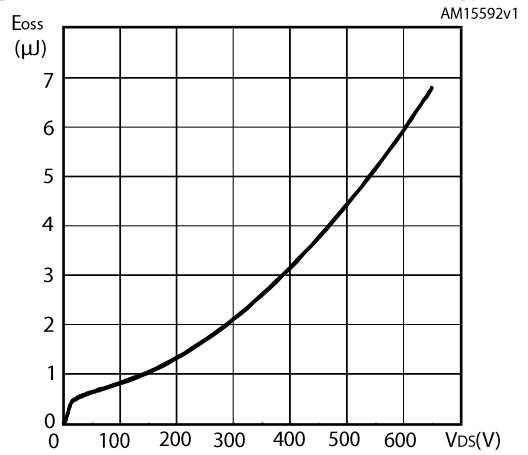

Figure 12: Normalized gate threshold voltage vs temperature

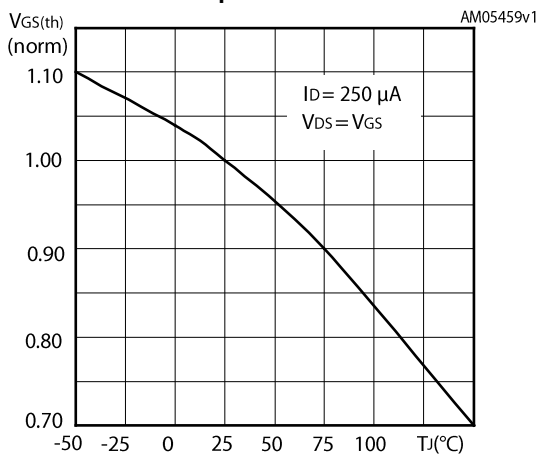
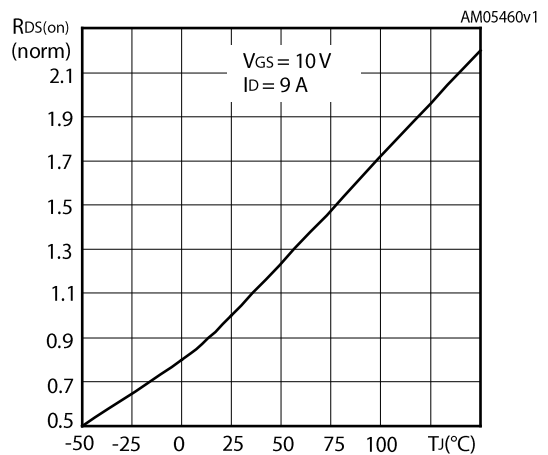
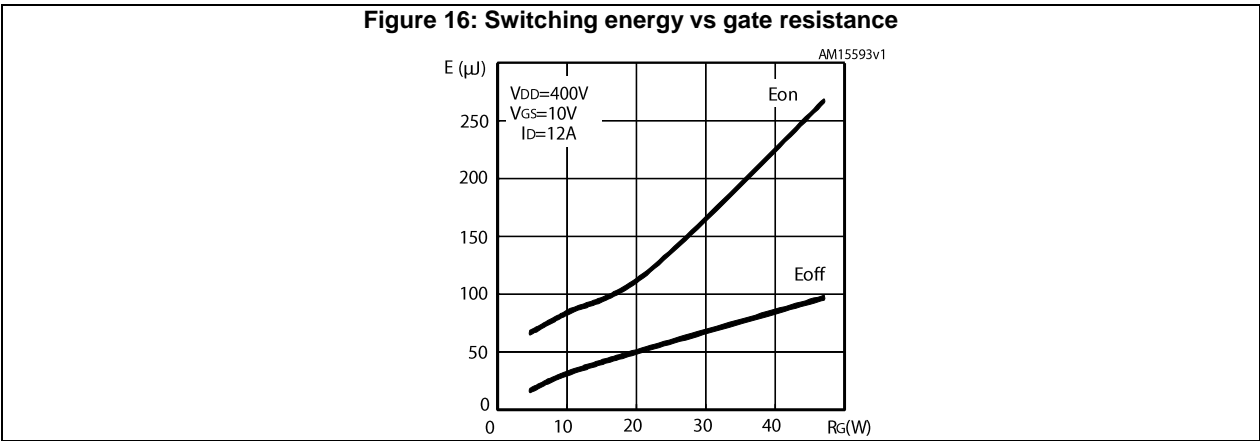
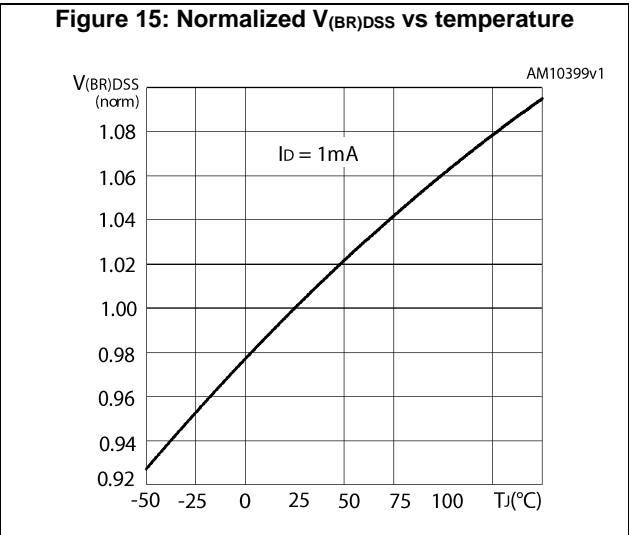
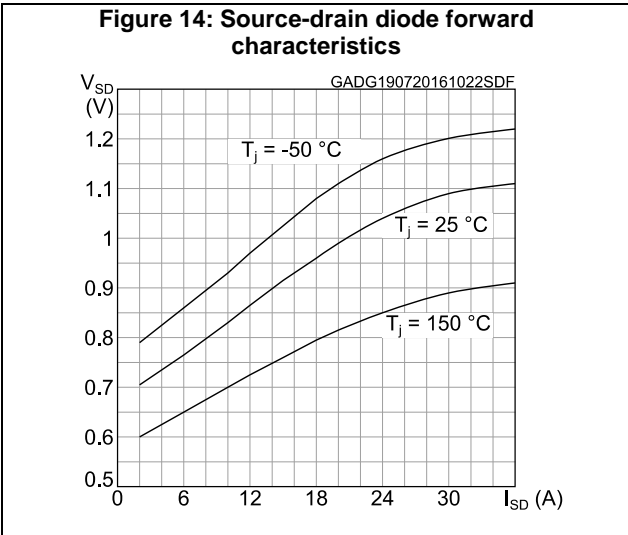

Figure 13: Normalized on-resistance vs temperature



Electrical characteristics

STF20N65M5,STFI20N65M5,STFW20N65M5



E_{on} including reverse recovery of a SiC diode.

3 Test circuits

Figure 17: Test circuit for resistive load switching times

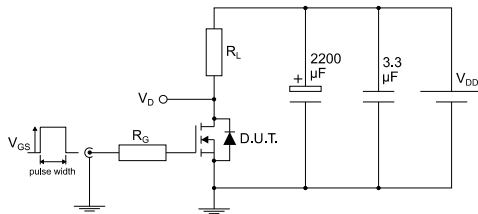

AM01468v1

Figure 18: Test circuit for gate charge behavior

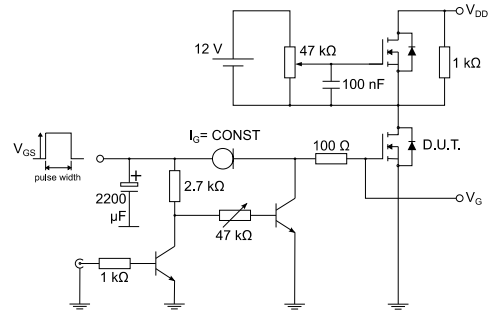

AM01469v1

Figure 19: Test circuit for inductive load switching and diode recovery times

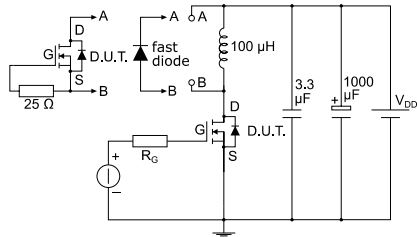

AM01470v1

Figure 20: Unclamped inductive load test circuit

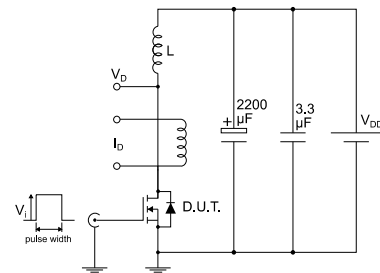

AM01471v1

Figure 21: Unclamped inductive waveform

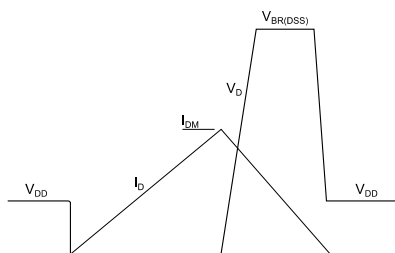

AM01472v1

Figure 22: Switching time waveform

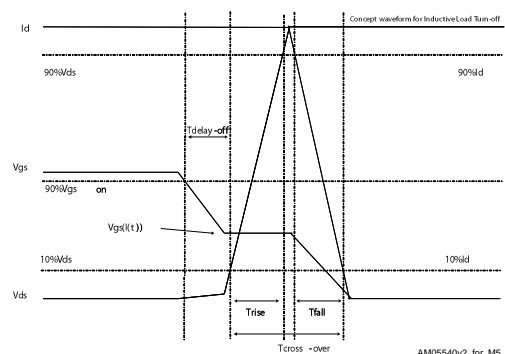

AM05540v2_for_M5

4 Package information

In order to meet environmental requirements, ST offers these devices in different grades of ECOPACK® packages, depending on their level of environmental compliance. ECOPACK® specifications, grade definitions and product status are available at: www.st.com. ECOPACK® is an ST trademark.

4.1 TO-220FP package information

Figure 23: TO-220FP package outline

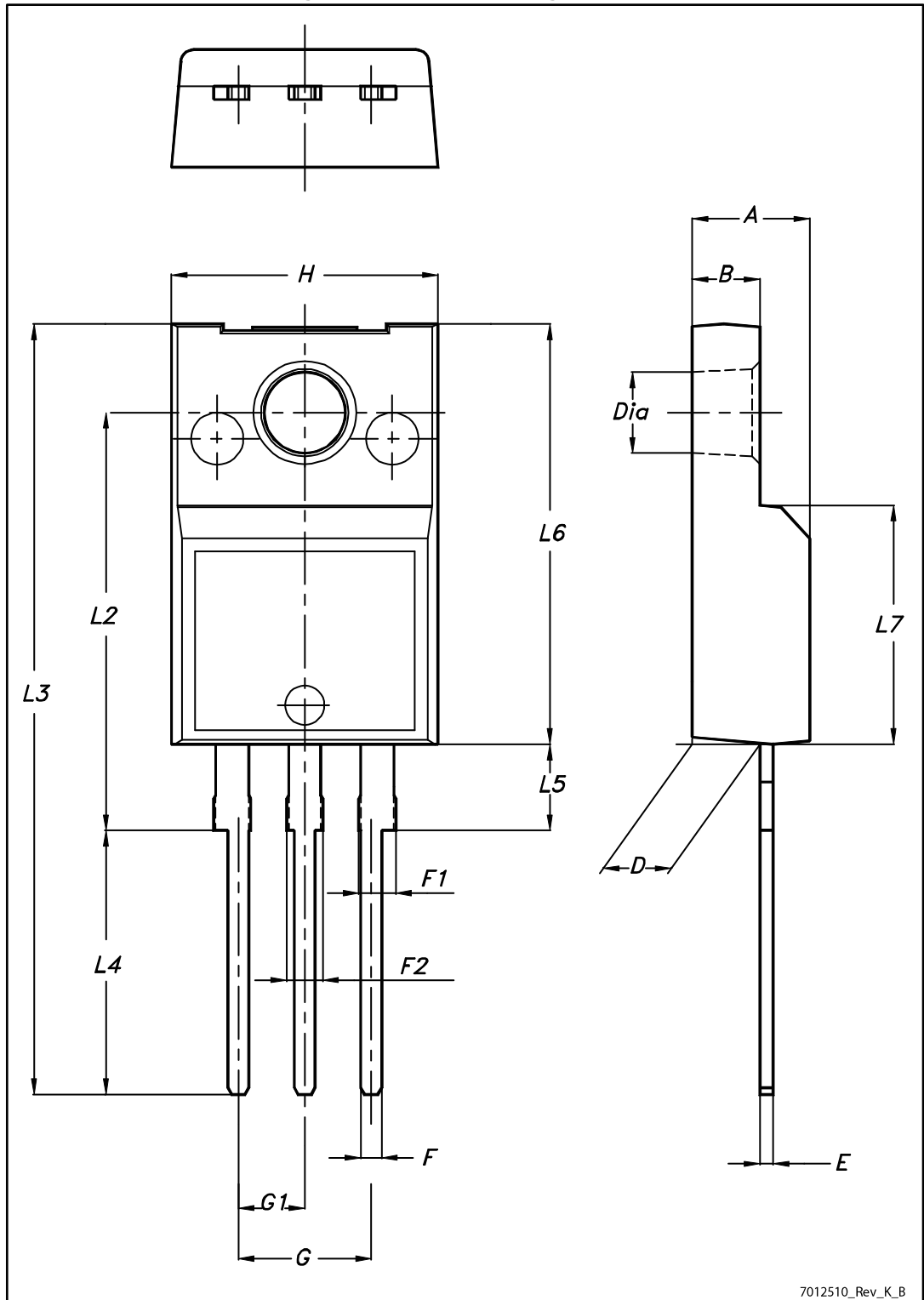

7012510_Rev_K_B

Table 9: TO-220FP package mechanical data

Dim.	mm		
	Min.	Typ.	Max.
A	4.4		4.6
B	2.5		2.7
D	2.5		2.75
E	0.45		0.7
F	0.75		1
F1	1.15		1.70
F2	1.15		1.70
G	4.95		5.2
G1	2.4		2.7
H	10		10.4
L2		16	
L3	28.6		30.6
L4	9.8		10.6
L5	2.9		3.6
L6	15.9		16.4
L7	9		9.3
Dia	3		3.2

4.2 I²PAKFP (TO-281) package information

Figure 24: I²PAKFP (TO-281) package outline

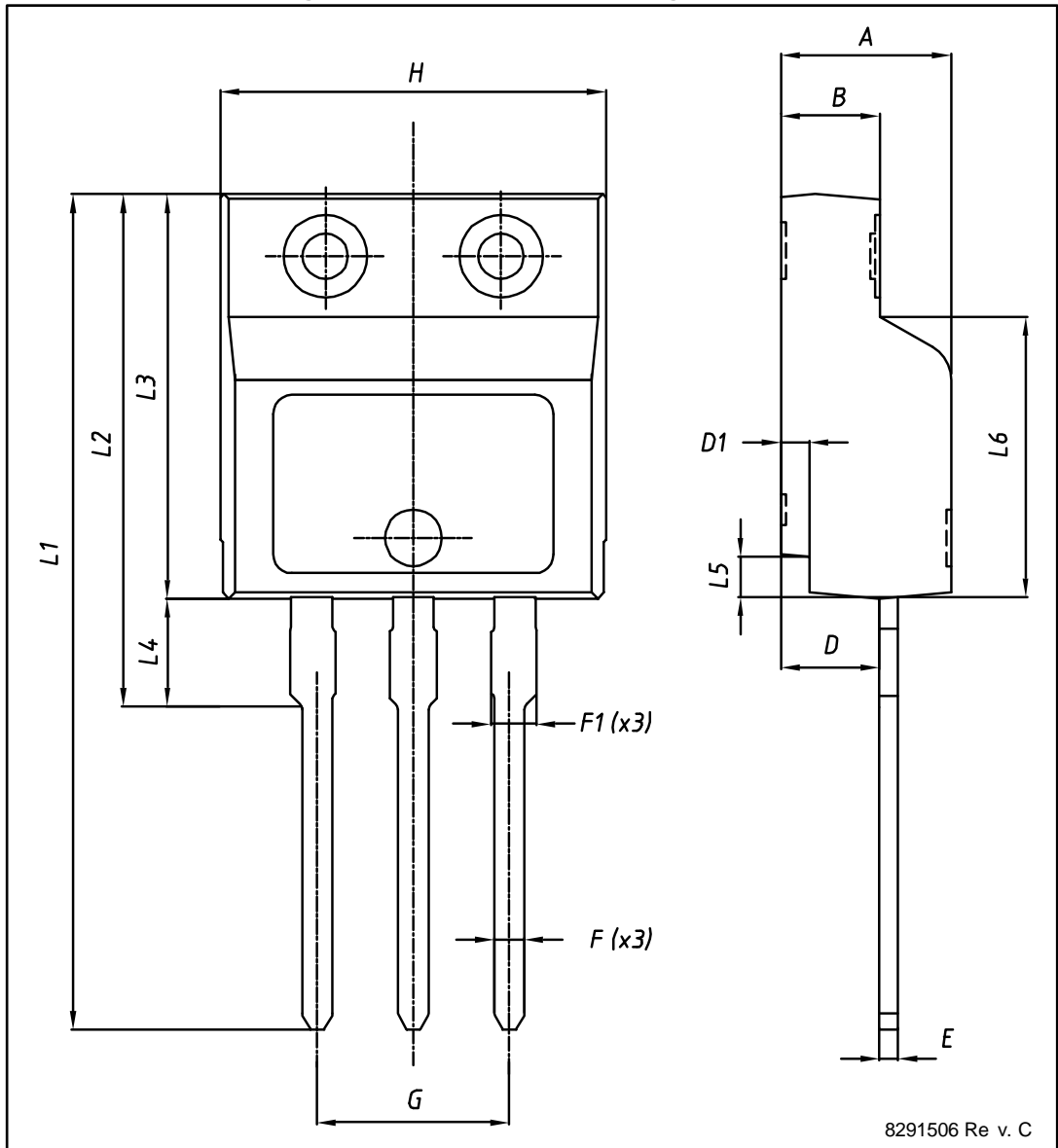

8291506 Re v. C

Table 10: I²PAKFP (TO-281) mechanical data

Dim.	mm		
	Min.	Typ.	Max.
A	4.40		4.60
B	2.50		2.70
D	2.50		2.75
D1	0.65		0.85
E	0.45		0.70
F	0.75		1.00
F1			1.20
G	4.95		5.20
H	10.00		10.40
L1	21.00		23.00
L2	13.20		14.10
L3	10.55		10.85
L4	2.70		3.20
L5	0.85		1.25
L6	7.50	7.60	7.70

4.3 TO-3PF package information

Figure 25: TO-3PF package outline

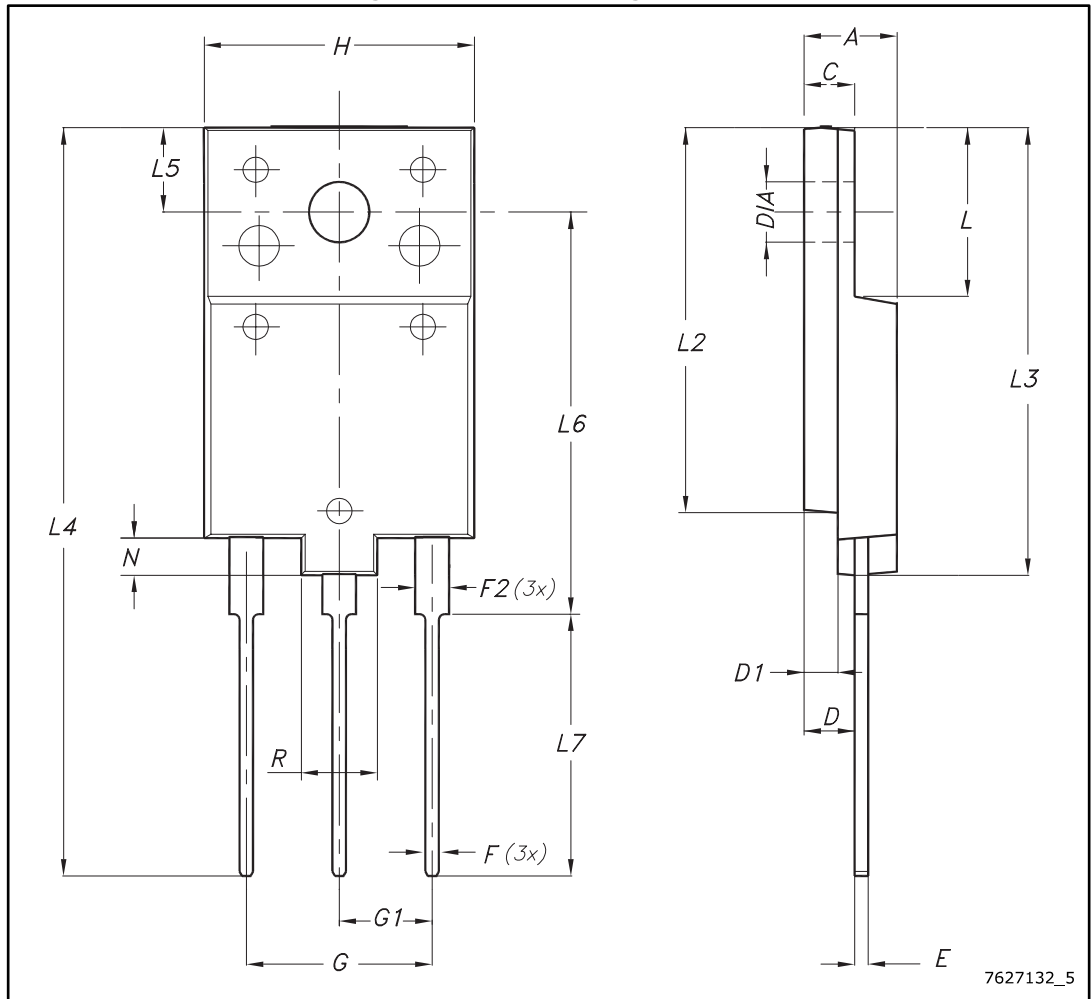

7627132_5

Table 11: TO-3PF mechanical data

Dim.	mm		
	Min.	Typ.	Max.
A	5.30		5.70
C	2.80		3.20
D	3.10		3.50
D1	1.80		2.20
E	0.80		1.10
F	0.65		0.95
F2	1.80		2.20
G	10.30		11.50
G1		5.45	
H	15.30		15.70
L	9.80	10	10.20
L2	22.80		23.20
L3	26.30		26.70
L4	43.20		44.40
L5	4.30		4.70
L6	24.30		24.70
L7	14.60		15
N	1.80		2.20
R	3.80		4.20
Dia	3.40		3.80

5 Revision history

Table 12: Document revision history

Date	Revision	Changes
01-Feb-2013	1	First release. Part numbers previously included in datasheet DM00049308
21-Jul-2016	2	Added device in TO-3PF. Modified: <i>Table 2: "Absolute maximum ratings", Table 5: "On /off states"</i> . Modified: <i>Figure 2: "Safe operating area for TO-220FP and I²PAKFP", Figure 4: "Safe operating area for TO-3PF", Figure 5: "Thermal impedance for TO-3PF"</i> . Minor text changes
22-Mar-2017	3	Modified <i>Table 2: "Absolute maximum ratings", Table 8: "Source drain diode"</i> . Modified <i>Figure 2: "Safe operating area for TO-220FP and I²PAKFP", Figure 4: "Safe operating area for TO-3PF", Figure 12: "Normalized gate threshold voltage vs temperature ", Figure 13: "Normalized on-resistance vs temperature" and Figure 14: "Source-drain diode forward characteristics "</i> . Minor text changes.

IMPORTANT NOTICE – PLEASE READ CAREFULLY

STMicroelectronics NV and its subsidiaries ("ST") reserve the right to make changes, corrections, enhancements, modifications, and improvements to ST products and/or to this document at any time without notice. Purchasers should obtain the latest relevant information on ST products before placing orders. ST products are sold pursuant to ST's terms and conditions of sale in place at the time of order acknowledgement.

Purchasers are solely responsible for the choice, selection, and use of ST products and ST assumes no liability for application assistance or the design of Purchasers' products.

No license, express or implied, to any intellectual property right is granted by ST herein.

Resale of ST products with provisions different from the information set forth herein shall void any warranty granted by ST for such product.

ST and the ST logo are trademarks of ST. All other product or service names are the property of their respective owners.

Information in this document supersedes and replaces information previously supplied in any prior versions of this document.





© 2017 STMicroelectronics – All rights reserved

Looking for pricing, stock, or lifecycle information?

Click below to explore more details on WIN SOURCE:

-  [View STFI20N65M5 on WIN SOURCE](#)
-  [STMicroelectronics Information](#)

Optimize Your Supply Chain with WIN SOURCE Solutions

-  Global Sourcing Solution
-  Obsolete Management
-  Cost Control Management
-  Shortage Management
-  Alternative Solution
-  Excess Inventory Management