



THE DATASHEET OF BSC0925NDATMA1



OptiMOS™ Power-MOSFET
Features

- Dual N-channel OptiMOS™ MOSFET
- Optimized for clean switching
- 100% avalanche tested
- Superior thermal resistance
- Optimized for high performance Buck converter
- Qualified according to JEDEC¹⁾ for target applications
- Pb-free lead plating; RoHS compliant
- Halogen-free according to IEC61249-2-21



Type	Package	Marking
BSC0925ND	PG-TISON-8	0925ND

Maximum ratings, at $T_j=25\text{ °C}$, unless otherwise specified²⁾

Parameter	Symbol	Conditions	Value	Unit
Continuous drain current	I_D	$V_{GS}=10\text{ V}, T_C=25\text{ °C}$	40	A
		$V_{GS}=4.5\text{ V}, T_A=25\text{ °C}^3)$	15	
		$V_{GS}=4.5\text{ V}, T_A=70\text{ °C}^3)$	12	
		$V_{GS}=10\text{ V}, T_A=25\text{ °C}^4)$	11	
Pulsed drain current ⁵⁾	$I_{D,pulse}$	$T_C=25\text{ °C}$	160	
Avalanche energy, single pulse	E_{AS}	$I_D=20\text{ A}, R_{GS}=25\text{ }\Omega$	14	mJ
Gate source voltage	V_{GS}		± 20	V

¹⁾ J-STD20 and JESD22

²⁾ One transistor active

³⁾ Device on 40 mm x 40 mm x 1.5 mm epoxy PCB FR4 with 6 cm² (one layer, 70 μm thick) copper area for drain connection. PCB is vertical in still air.

⁴⁾ Device mounted on a minimum pad (one layer, 70 μm thick). One transistor active

⁵⁾ See figure 3 for more detailed information.

Product Summary

V_{DS}	30	V
$R_{DS(on),max}$	5	m Ω
I_D	40	A
Q_{OSS}	8.6	nC
$Q_G(0V..10V)$	13	nC

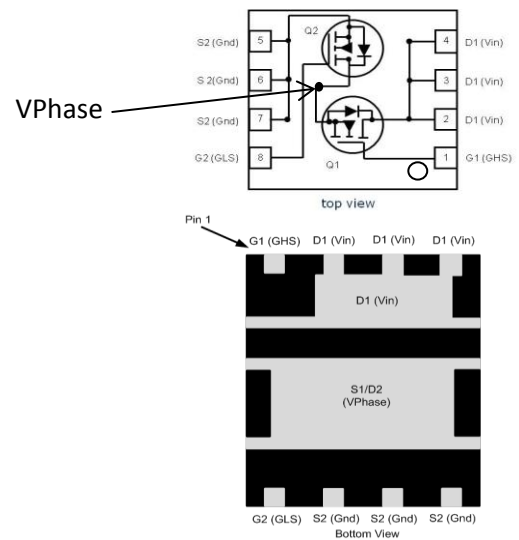

Maximum ratings, at $T_j=25\text{ °C}$, unless otherwise specified

Parameter	Symbol	Conditions	Value	Unit
Power dissipation	P_{tot}	$T_C=25\text{ °C}$	30	W
		$T_A=25\text{ °C}$, $R_{\text{thJA}}=50\text{ K/W}^{(3)}$	2.5	
Operating and storage temperature	T_j, T_{stg}		-55 ... 150	°C
IEC climatic category; DIN IEC 68-1			55/150/56	

Parameter	Symbol	Conditions	Values			Unit
			min.	typ.	max.	

Thermal characteristics

Thermal resistance, junction - case	R_{thJC}		-	-	4.2	K/W
		top	-	-	20	
Device on PCB	R_{thJA}	6 cm ² cooling area ⁽³⁾	-	-	50	
		minimum footprint ⁽⁴⁾	-	-	125	

Electrical characteristics, at $T_j=25\text{ °C}$, unless otherwise specified

Static characteristics

Drain-source breakdown voltage	$V_{(\text{BR})\text{DSS}}$	$V_{\text{GS}}=0\text{ V}$, $I_{\text{D}}=1\text{ mA}$	30	-	-	V
Gate threshold voltage	$V_{\text{GS(th)}}$	$V_{\text{DS}}=V_{\text{GS}}$, $I_{\text{D}}=250\text{ }\mu\text{A}$	1.2	-	2.0	
Zero gate voltage drain current	I_{DSS}	$V_{\text{DS}}=30\text{ V}$, $V_{\text{GS}}=0\text{ V}$, $T_j=25\text{ °C}$	-	0.1	1	μA
		$V_{\text{DS}}=30\text{ V}$, $V_{\text{GS}}=0\text{ V}$, $T_j=125\text{ °C}$	-	10	100	
Gate-source leakage current	I_{GSS}	$V_{\text{GS}}=20\text{ V}$, $V_{\text{DS}}=0\text{ V}$	-	10	100	nA
Drain-source on-state resistance	$R_{\text{DS(on)}}$	$V_{\text{GS}}=4.5\text{ V}$, $I_{\text{D}}=20\text{ A}$	-	5.6	7	m Ω
		$V_{\text{GS}}=10\text{ V}$, $I_{\text{D}}=20\text{ A}$	-	4.2	5	
Gate resistance	R_{G}		1.3	2.6	5.2	Ω
Transconductance	g_{fs}	$ V_{\text{DS}} >2 I_{\text{D}} R_{\text{DS(on)max}}$, $I_{\text{D}}=30\text{ A}$	38	77	-	S

Parameter	Symbol	Conditions	Values			Unit
			min.	typ.	max.	

Dynamic characteristics

Input capacitance	C_{iss}	$V_{GS}=0\text{ V}, V_{DS}=15\text{ V}, f=1\text{ MHz}$	-	870	1157	pF
Output capacitance	C_{oss}		-	330	439	
Reverse transfer capacitance	C_{rss}		-	49	-	
Turn-on delay time	$t_{d(on)}$	$V_{DD}=15\text{ V}, V_{GS}=10\text{ V}, I_D=20\text{ A}, R_{G,ext}=1.6\ \Omega$	-	4.7	-	ns
Rise time	t_r		-	3.8	-	
Turn-off delay time	$t_{d(off)}$		-	17	-	
Fall time	t_f		-	3.0	-	

Gate Charge Characteristics⁶⁾

Gate to source charge	Q_{gs}	$V_{DD}=15\text{ V}, I_D=30\text{ A}, V_{GS}=0\text{ to }4.5\text{ V}$	-	2.4	3.2	nC
Gate charge at threshold	$Q_{g(th)}$		-	1.4	-	
Gate to drain charge	Q_{gd}		-	2.2	2.9	
Switching charge	Q_{sw}		-	3.2	-	
Gate charge total	Q_g		-	6.7	8.9	
Gate plateau voltage	$V_{plateau}$		-	2.8	-	V
Gate charge total	Q_g	$V_{DD}=15\text{ V}, I_D=30\text{ A}, V_{GS}=0\text{ to }10\text{ V}$	-	13	17	nC
Gate charge total, sync. FET	$Q_{g(sync)}$	$V_{DS}=0.1\text{ V}, V_{GS}=0\text{ to }4.5\text{ V}$	-	5.4	-	
Output charge	Q_{oss}	$V_{DD}=15\text{ V}, V_{GS}=0\text{ V}$	-	8.6	11	

Reverse Diode

Diode continuous forward current	I_S	$T_C=25\text{ }^\circ\text{C}$	-	-	30	A
Diode pulse current	$I_{S,pulse}$		-	-	120	
Diode forward voltage	V_{SD}	$V_{GS}=0\text{ V}, I_F=20\text{ A}, T_j=25\text{ }^\circ\text{C}$	-	0.87	1	V
Reverse recovery charge	Q_{rr}	$V_R=15\text{ V}, I_F=I_S, di_F/dt=400\text{ A}/\mu\text{s}$	-	5	-	nC

⁶⁾ See figure 16 for gate charge parameter definition

1 Power dissipation

$P_{tot}=f(T_C)$

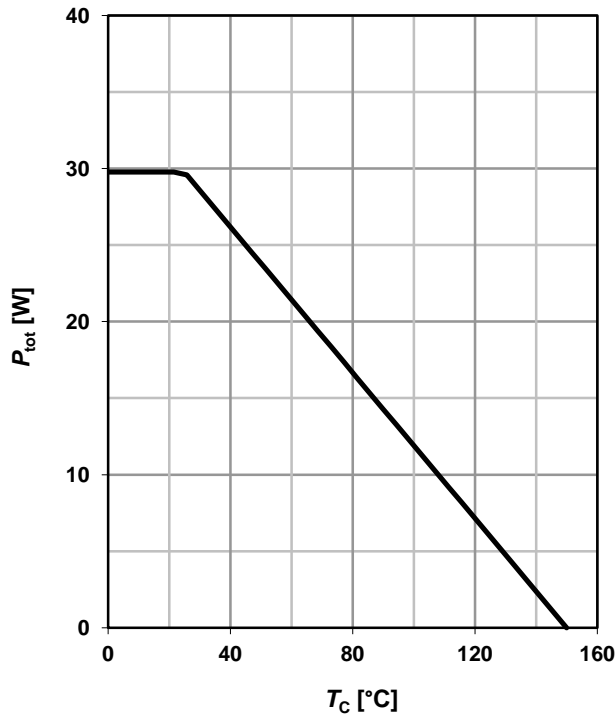

2 Drain current

$I_D=f(T_C); V_{GS} \geq 10\text{ V}$

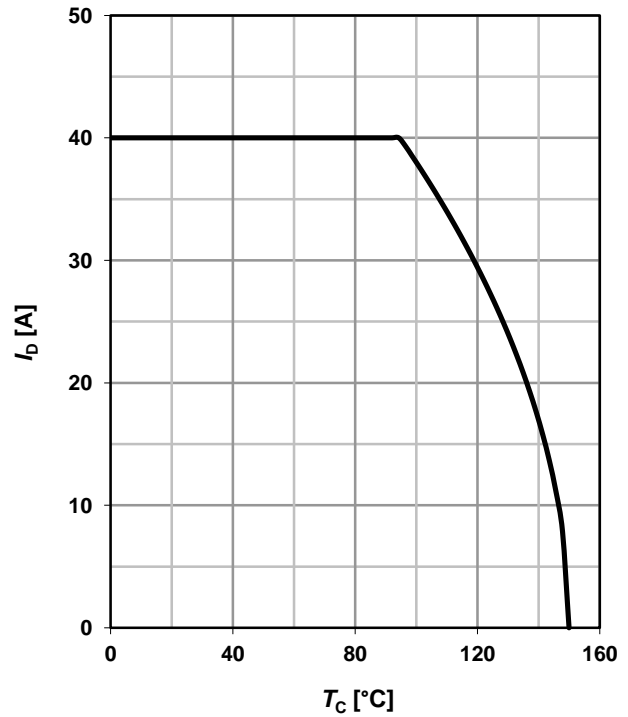

3 Safe operating area

$I_D=f(V_{DS}); T_C=25\text{ °C}; D=0$

parameter: t_p

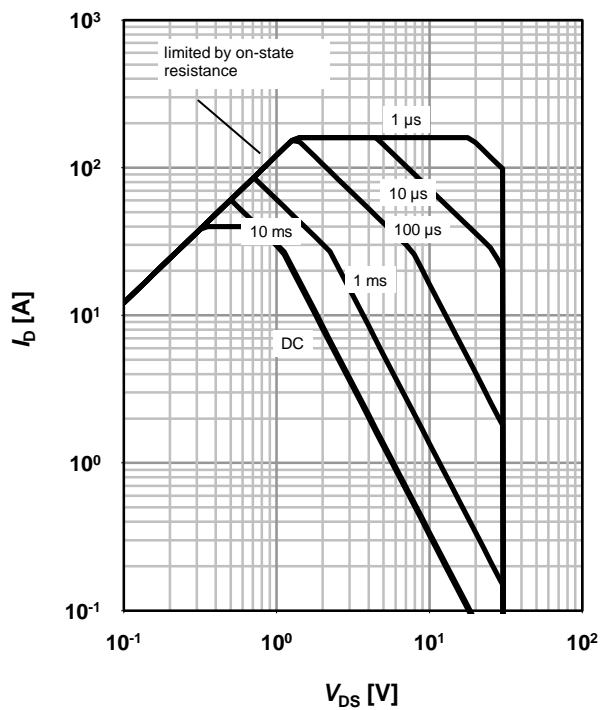

4 Max. transient thermal impedance

$Z_{thJC}=f(t_p)$

parameter: $D=t_p/T$

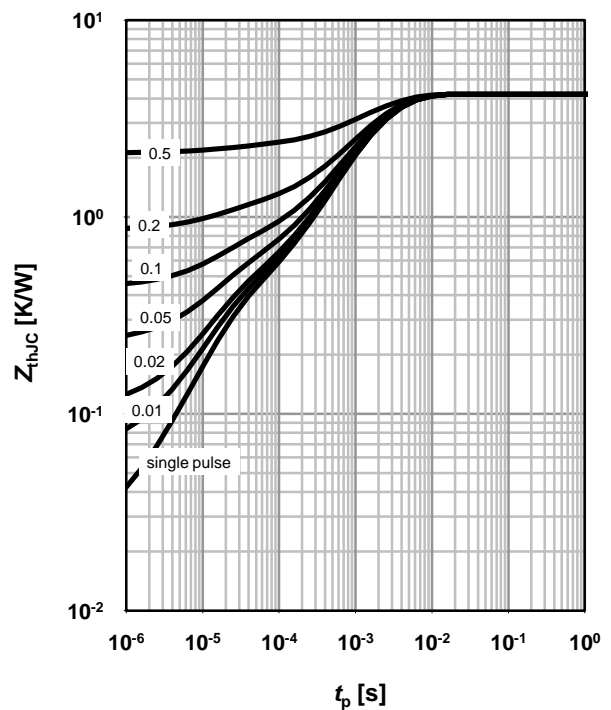

5 Typ. output characteristics

$I_D = f(V_{DS}); T_j = 25\text{ °C}$

parameter: V_{GS}

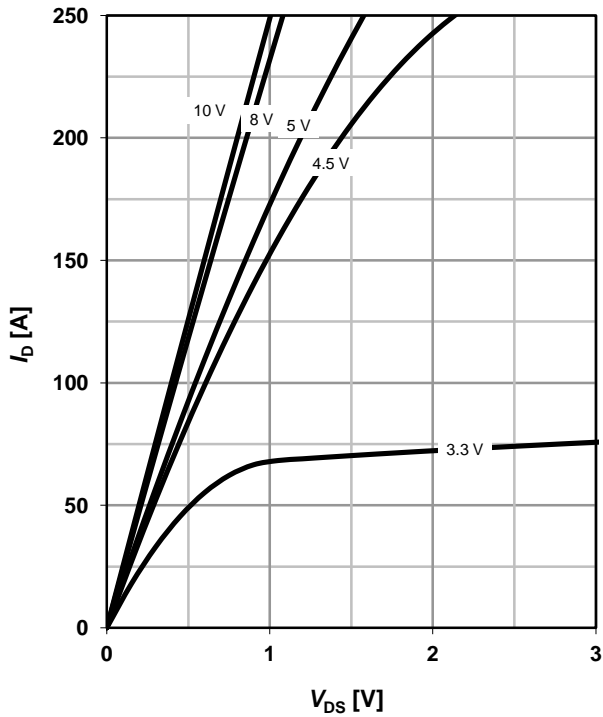

6 Typ. drain-source on resistance

$R_{DS(on)} = f(I_D); T_j = 25\text{ °C}$

parameter: V_{GS}

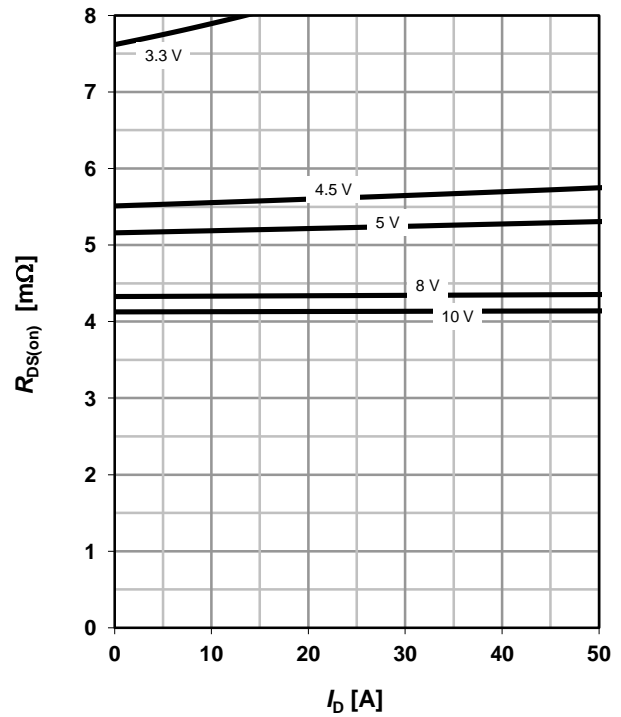

7 Typ. transfer characteristics

$I_D = f(V_{GS}); |V_{DS}| > 2|I_D|R_{DS(on)max}$

parameter: T_j

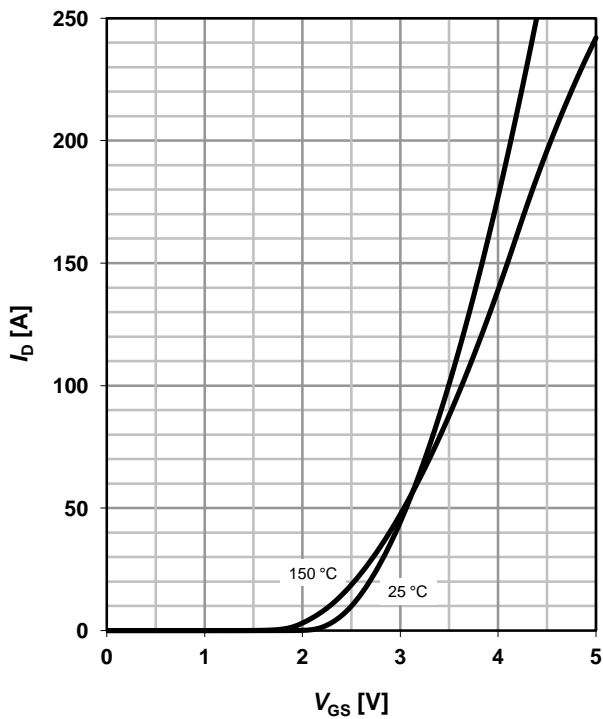

8 Typ. forward transconductance

$g_{fs} = f(I_D); T_j = 25\text{ °C}$

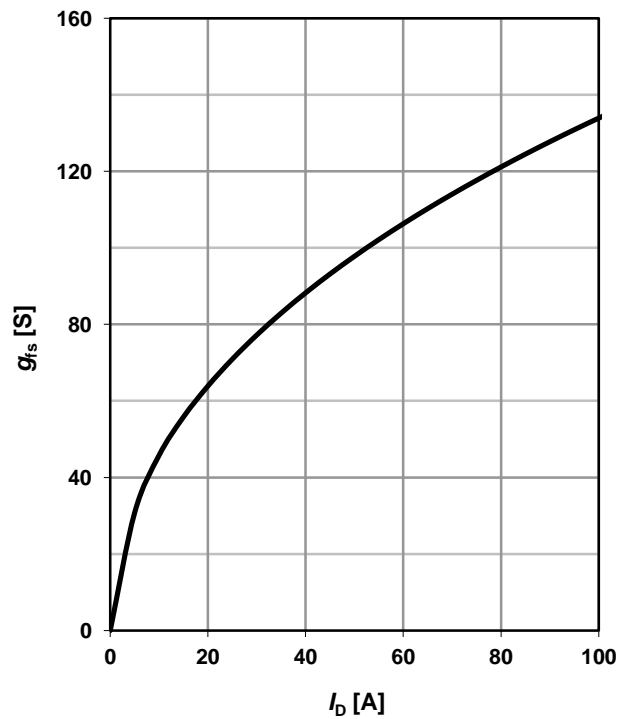

9 Drain-source on-state resistance

$R_{DS(on)}=f(T_j); I_D=20\text{ A}; V_{GS}=10\text{ V}$

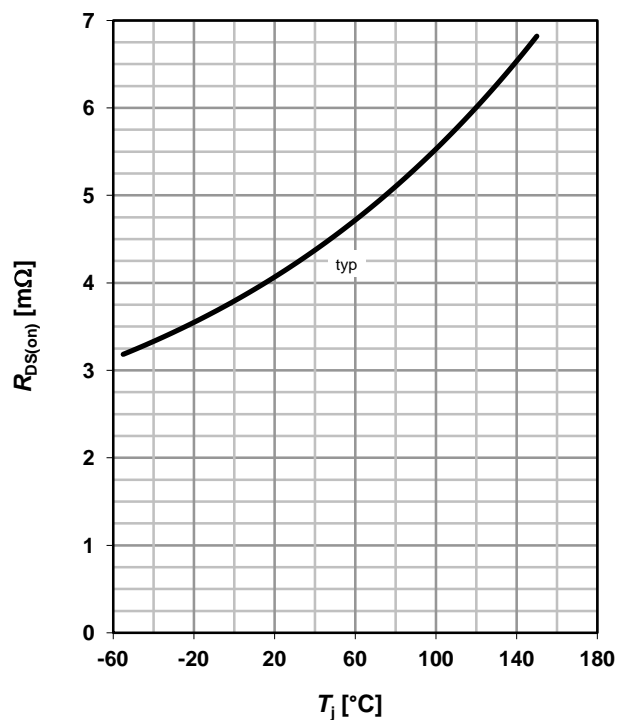

10 Typ. gate threshold voltage

$V_{GS(th)}=f(T_j); V_{GS}=V_{DS}; I_D=250\ \mu\text{A}$

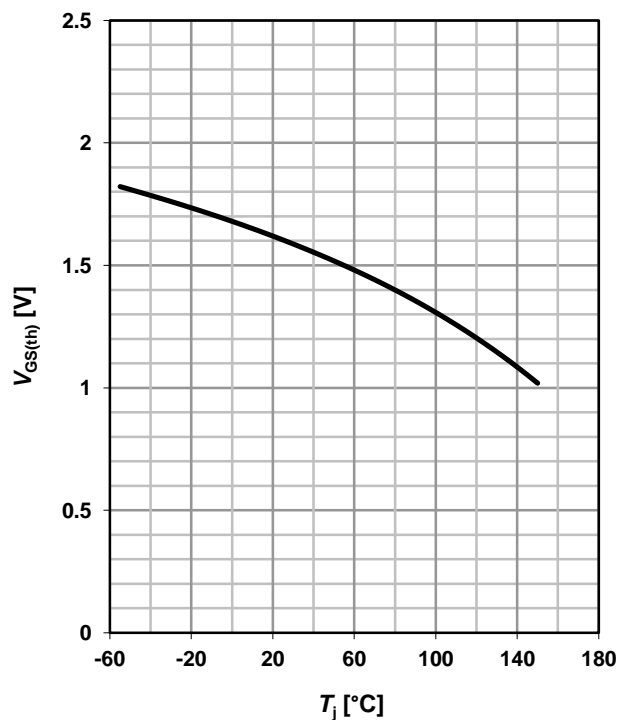

11 Typ. capacitances

$C=f(V_{DS}); V_{GS}=0\text{ V}; f=1\text{ MHz}$

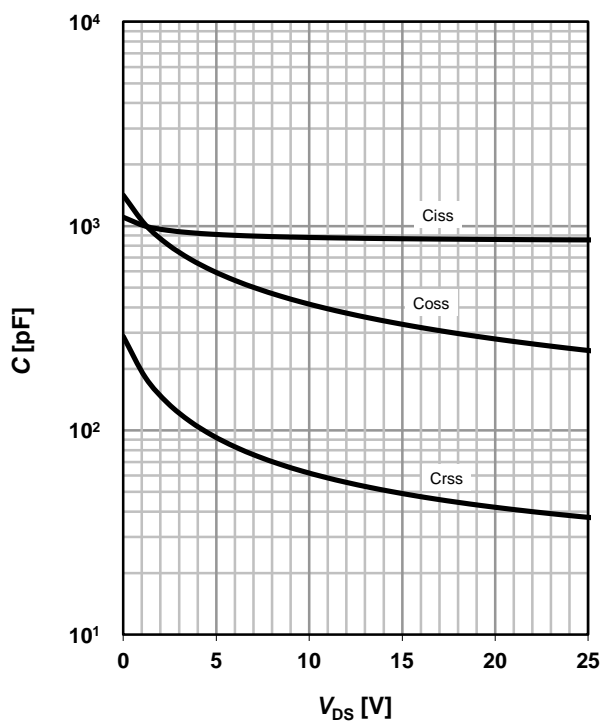

12 Forward characteristics of reverse diode

$I_F=f(V_{SD})$

parameter: T_j

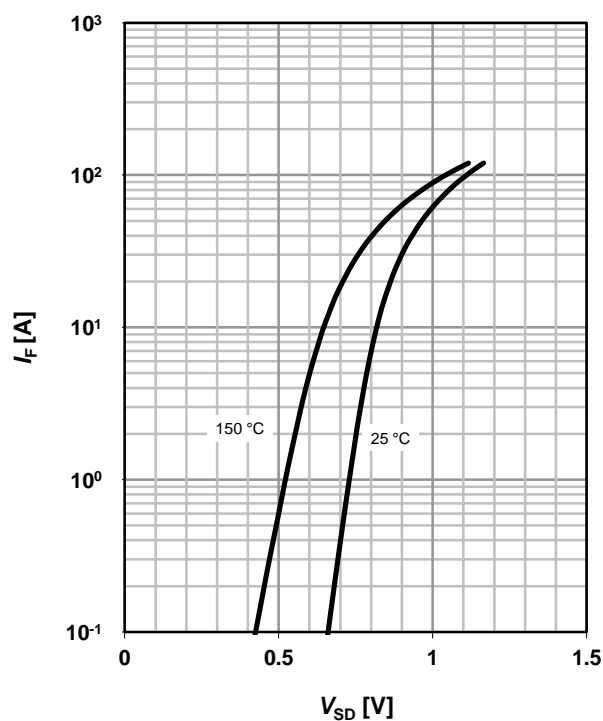

13 Avalanche characteristics

$I_{AS}=f(t_{AV}); R_{GS}=25 \Omega$

parameter: $T_{j(\text{start})}$

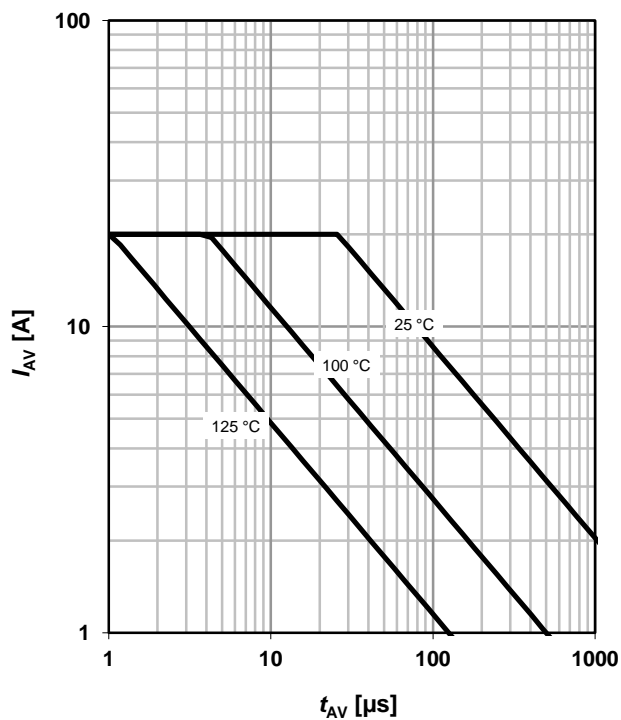

14 Typ. gate charge

$V_{GS}=f(Q_{\text{gate}}); I_D=30 \text{ A pulsed}$

parameter: V_{DD}

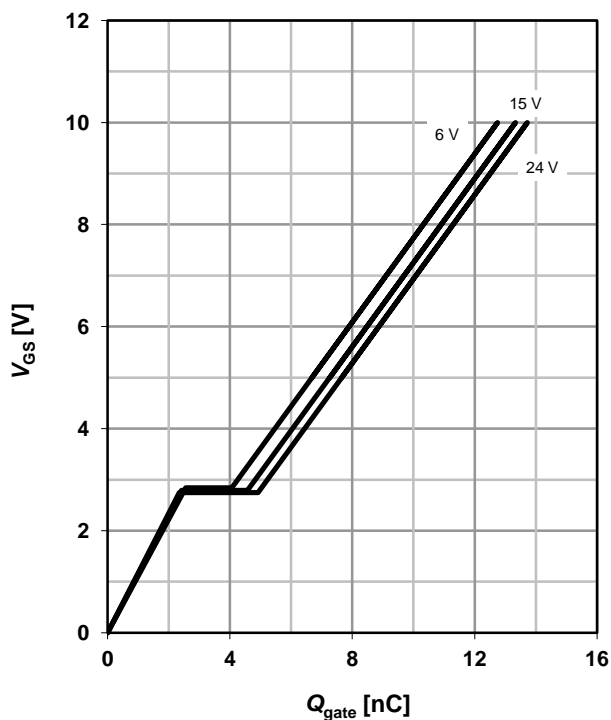

15 Drain-source breakdown voltage

$V_{BR(DSS)}=f(T_j); I_D=1 \text{ mA}$

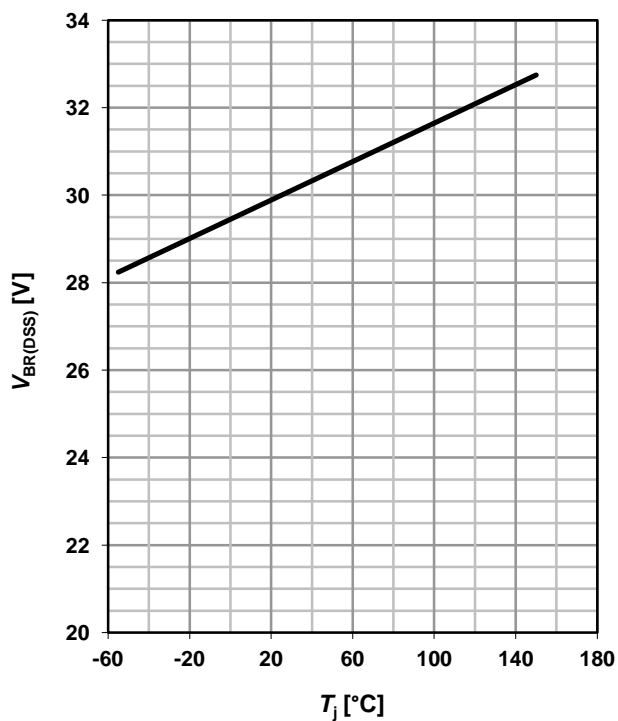

16 Gate charge waveforms

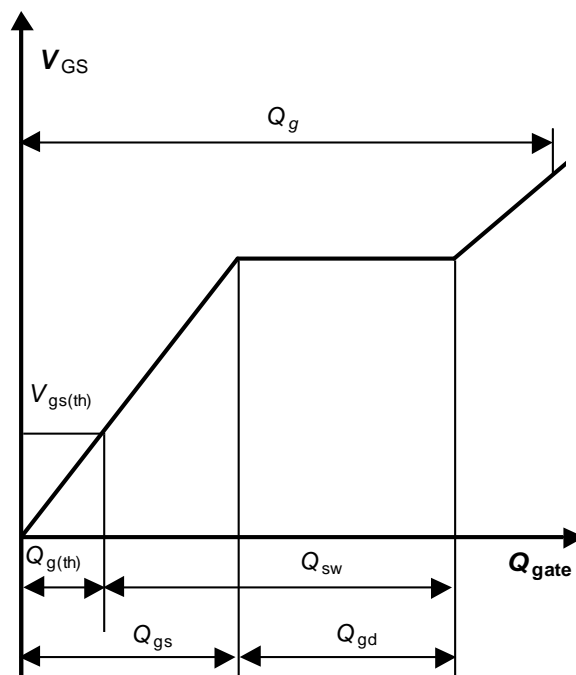

Package Outline

PG-TISON

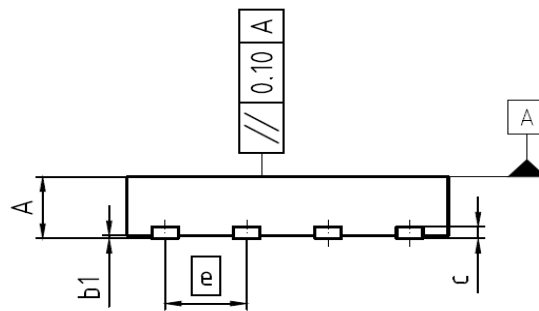
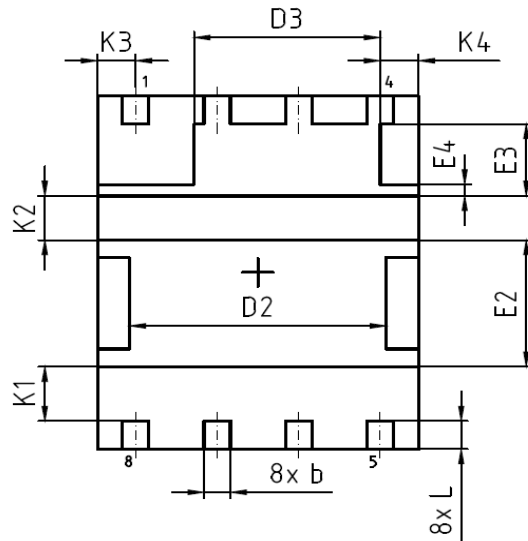
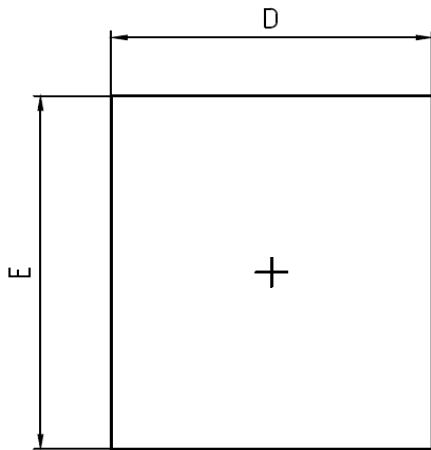

DIM	MILLIMETERS		INCHES	
	MIN	MAX	MIN	MAX
A	0.90	1.15	0.035	0.045
b	0.31	0.51	0.012	0.020
b1	0.00	0.05	0.000	0.002
c	0.10	0.30	0.004	0.012
D	4.90	5.10	0.193	0.201
D2	3.90	4.10	0.154	0.161
D3	2.80	3.00	0.110	0.118
E	5.90	6.10	0.232	0.240
E2	2.05	2.25	0.081	0.089
E3	1.12	1.32	0.044	0.052
E4	0.10	0.30	0.004	0.012
e	1.27 (BSC)		0.05 (BSC)	
N	8		8	
L	0.38	0.58	0.015	0.023
K1	0.82	1.02	0.032	0.040
K2	0.65	0.85	0.026	0.033
K3 = K4	0.50	0.70	0.019	0.027

DOCUMENT NO.
Z8B00162738

SCALE

EUROPEAN PROJECTION

ISSUE DATE
21-09-2011

REVISION
01

PG-TISON

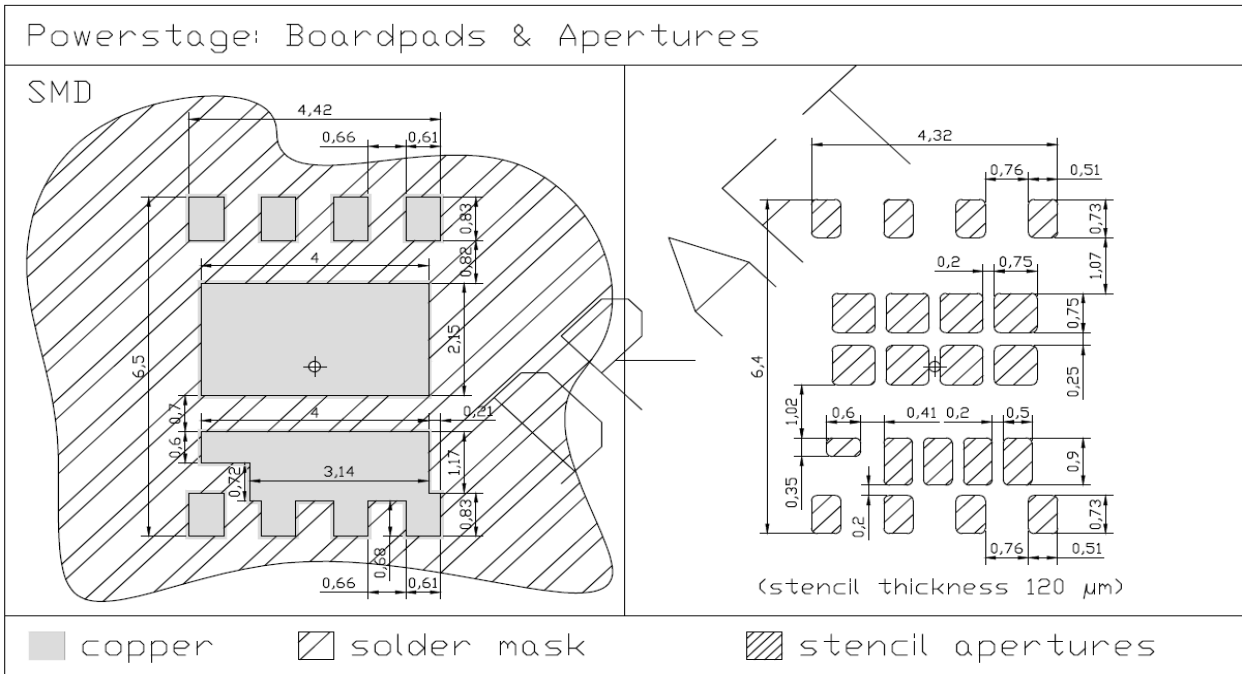

Dimensions in mm

Published by
Infineon Technologies AG
81726 Munich, Germany
© 2012 Infineon Technologies AG
All Rights Reserved.

Legal Disclaimer

The information given in this document shall in no event be regarded as a guarantee of conditions or characteristics. With respect to any examples or hints given herein, any typical values stated herein and/or any information regarding the application of the device, Infineon Technologies hereby disclaims any and all warranties and liabilities of any kind, including without limitation, warranties of non-infringement of intellectual property rights of any third party.

Information

For further information on technology, delivery terms and conditions and prices, please contact the nearest Infineon Technologies Office (www.infineon.com).

Warnings







Due to technical requirements, components may contain dangerous substances. For information on the types in question, please contact the nearest Infineon Technologies Office. Infineon Technologies components may be used in life-support devices or systems only with the express written approval of Infineon Technologies, if a failure of such components can reasonably be expected to cause the failure of that life-support device or system or to affect the safety or effectiveness of that device or system. Life support devices or systems are intended to be implanted in the human body or to support and/or maintain and sustain and/or protect human life. If they fail, it is reasonable to assume that the health of the user or other persons may be endangered.

Looking for pricing, stock, or lifecycle information?

Click below to explore more details on WIN SOURCE:

-  [View BSC0925NDATMA1 on WIN SOURCE](#)
-  [Infineon Technologies](#) Information

Optimize Your Supply Chain with WIN SOURCE Solutions

-  Global Sourcing Solution
-  Obsolete Management
-  Cost Control Management
-  Shortage Management
-  Alternative Solution
-  Excess Inventory Management