



**THE DATASHEET OF  
AH373-PG-A**



## Description

AH373 is a single-digital-output Hall-Effect latch sensor with internal pull-up resistor for high temperature operation. The device includes an on-chip Hall voltage generator for magnetic sensing, an amplifier to amplify Hall voltage, and a comparator to provide switching hysteresis for noise rejection, and an output driver with a pull-up resistor. An internal band-gap regulator provides a temperature compensated supply voltage for internal circuits and allows a wide operating supply range.

When the magnetic flux density (**B**) perpendicular to the package is larger than operate point (**Bop**), output is switched on (OUT pin is pulled low). The output state is held on until a magnetic flux density reversal falls below Brp. When **B** is less than Brp, the output is switched off.

The AH373 is available in SIP-3, SC59 and SOT23 packages.

## Features

- Bipolar Hall Effect Latch Operation
- 2.2V to 20V Operating Range
- Single Output with Built-in Pull-up Resistor
- 25mA Output Sink Capability
- -40°C to +125°C Operating Temperature
- Industry Standard SIP-3, SC59 and SOT23 Packages
- **Totally Lead-Free & Fully RoHS Compliant (Notes 1 & 2)**
- **Halogen and Antimony Free. "Green" Device (Note 3)**

- Notes:
1. No purposely added lead. Fully EU Directive 2002/95/EC (RoHS) & 2011/65/EU (RoHS 2) compliant.
  2. See [http://www.diodes.com/quality/lead\\_free.html](http://www.diodes.com/quality/lead_free.html) for more information about Diodes Incorporated's definitions of Halogen- and Antimony-free, "Green" and Lead-free.
  3. Halogen- and Antimony-free "Green" products are defined as those which contain <900ppm bromine, <900ppm chlorine (<1500ppm total Br + Cl) and <1000ppm antimony compounds.

## Pin Assignments

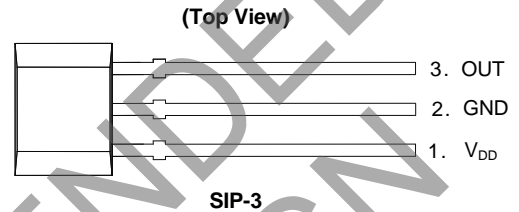
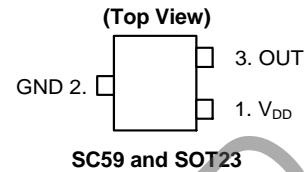

## Applications

- Rotor Position Sensing for Motor Commutation
- Encoder
- Speed Measurement – RPM Monitor
- Contact-less Current Switch

## Typical Application Circuits

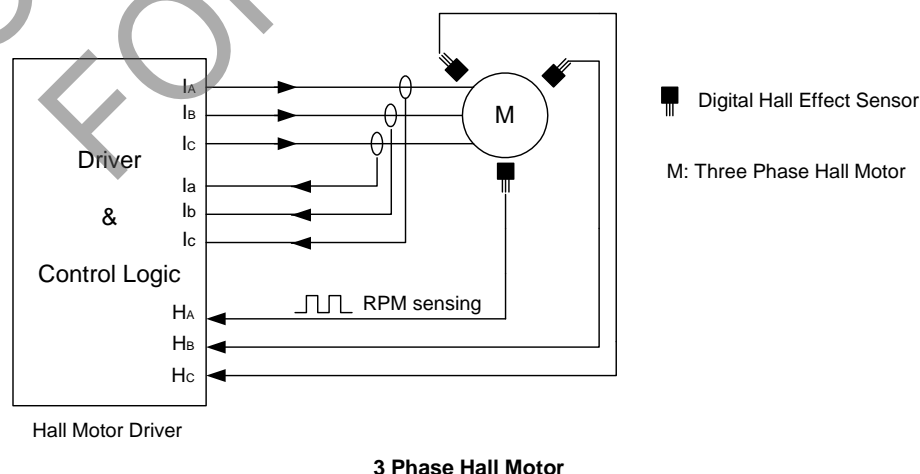

**Typical Application Circuits** (Cont.)

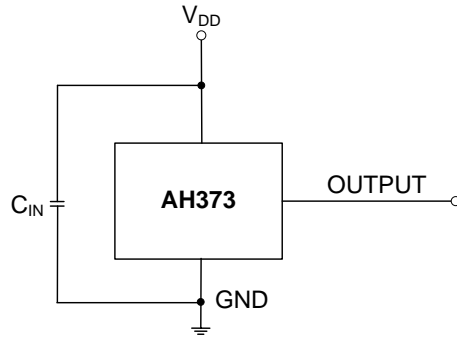

**Typical AH373 Circuit**

Note: 4.  $C_{IN}$  is for power stabilization and to strengthen the noise immunity, the recommended capacitance is 100nF typical.

**Pin Descriptions**

Packages: SC59, SOT23 and SIP-3

Pin Number	Pin Name	Function
1	V <sub>DD</sub>	Power Supply Input
2	GND	Ground
3	OUTPUT	Output

**Functional Block Diagram**

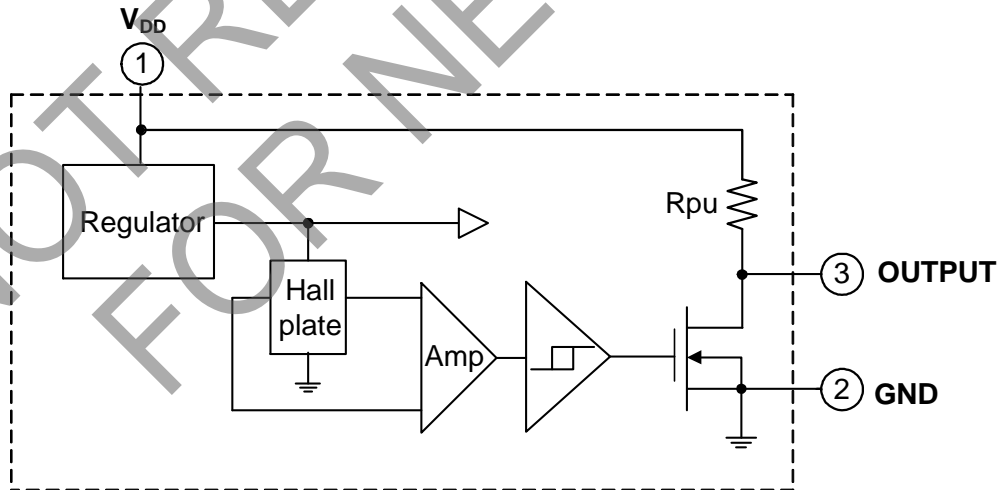

**Absolute Maximum Ratings** (Note 5) @ $T_A = +25^{\circ}\text{C}$ , unless otherwise specified.)

Symbol	Characteristics	Value	Unit
$V_{DD}$	Supply Voltage (Note 6)	28	V
$V_{OUT}$ (Off)	Output "Off" Voltage	28	V
$I_O$ (Sink)	Output "On" Current (Sink)	25	mA
B	Magnetic Flux Density	Unlimited	
$P_D$	Package Power Dissipation	SIP-3	550 mW
		SC59 and SOT23	230 mW
$T_S$	Storage Temperature Range	-65 to +150	$^{\circ}\text{C}$
$T_J$	Maximum Junction Temperature	+150	$^{\circ}\text{C}$

- Notes:
- Stresses greater than the 'Absolute Maximum Ratings' specified above may cause permanent damage to the device. These are stress ratings only; functional operation of the device at these or any other conditions exceeding those indicated in this specification is not implied. Device reliability may be affected by exposure to absolute maximum rating conditions for extended periods of time.
  - The absolute maximum  $V_{DD}$  of 28V is a transient stress rating and is not meant as a functional operating condition. It is not recommended to operate the device at the absolute maximum rated conditions for any period of time.

**Recommended Operating Conditions** (@ $T_A = +25^{\circ}\text{C}$ , unless otherwise specified.)

Symbol	Characteristic	Conditions	Rating	Unit
$V_{DD}$	Supply Voltage (Note 7)	Operating	2.2 to 20	V
$T_A$	Operating Temperature Range	Operating	-40 to +125	$^{\circ}\text{C}$

- Note: 7. The output of IC will be switched after the supply voltage is over 2.2V, but the magnetic characteristics will not be normal until the supply is over 2.5V.

**Electrical Characteristics** (@ $T_A = +25^{\circ}\text{C}$ ,  $V_{DD} = 12\text{V}$ , unless otherwise specified.)

Symbol	Characteristic	Conditions	Min	Typ	Max	Unit
$V_{OUT}$	Output On Voltage	$I_{OUT} = 20\text{mA}$	—	300	400	mV
$I_{DD}$	Supply Current	$B < Brp$	—	2	4	mA
$I_{OFF}$	Output Leakage Current	Output off	—	< 0.1	10	$\mu\text{A}$
$R_{pu}$	Internal Pull-up Resistor	—	7	10	13	k $\Omega$

**Magnetic Characteristics** (Note 8) (@ $T_A = +25^\circ\text{C}$ ,  $V_{DD} = 2.5\text{V}$  to  $20\text{V}$ , unless otherwise specified.)

(1mT=10 Gauss)

Symbol	Characteristic	Min	Typ	Max	Unit
Bop (South pole to part marking side for SIP-3 and SOT23; North pole to part marking side for SC59)	Operation Point	5	30	60	Gauss
Brp (South pole to part marking side for SIP-3 and SOT23; North pole to part marking side for SC59)	Release Point	-60	-30	-5	
Bhy ( Bopx - Brpx )	Hysteresis	—	60	—	

Note: 8. The magnetic characteristics may vary with supply voltage, operating temperature and after soldering.

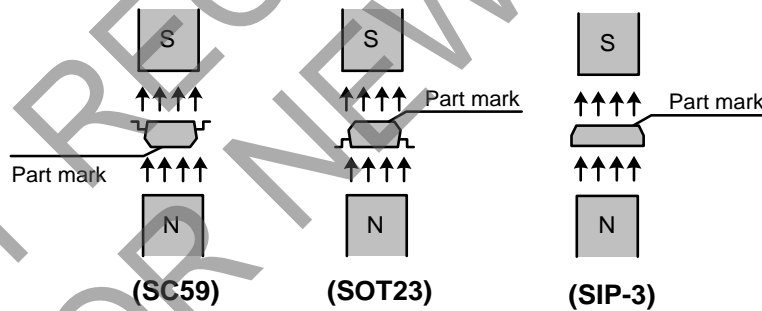
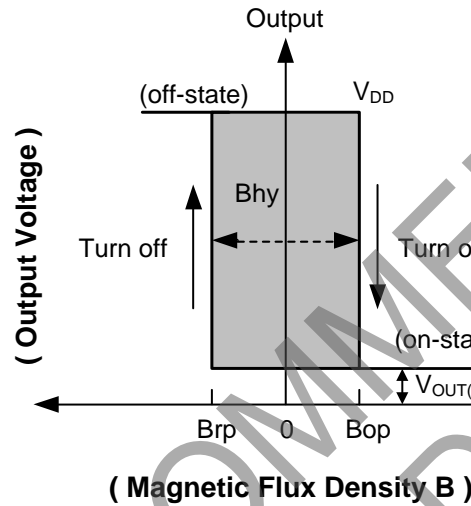

**Thermal Performance Characteristics**

**(1) Package Type: SIP-3**

T <sub>A</sub> (°C)	25	50	60	70	80	85	90	95	100	105	110	115	120	125	130	135	140	150
P <sub>D</sub> (mW)	550	440	396	352	308	286	264	242	220	198	176	154	132	110	88	66	44	0

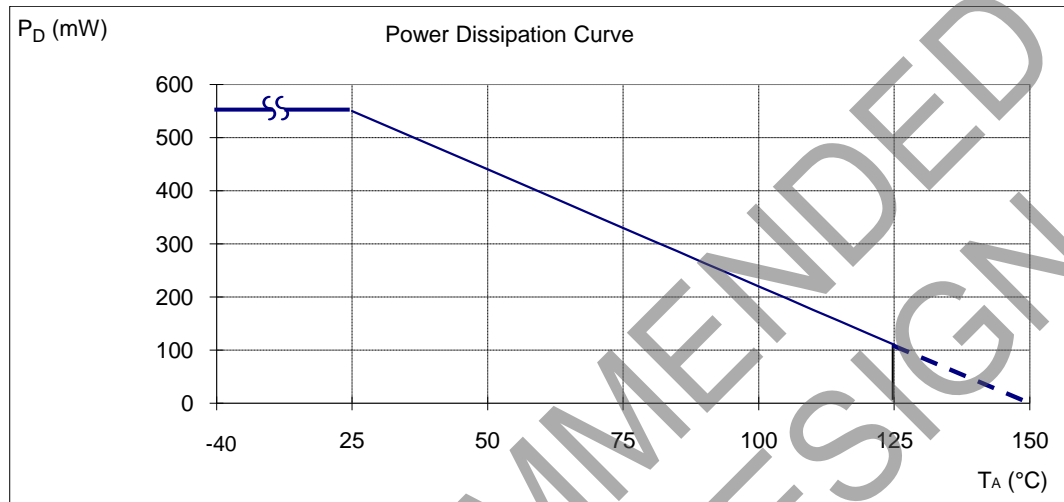

**(2) Package Type: SC59 and SOT23**

T <sub>A</sub> (°C)	25	50	60	70	80	85	90	100	105	110	120	125	130	140	150
P <sub>D</sub> (mW)	230	184	166	147	129	120	110	92	83	74	55	46	37	18	0

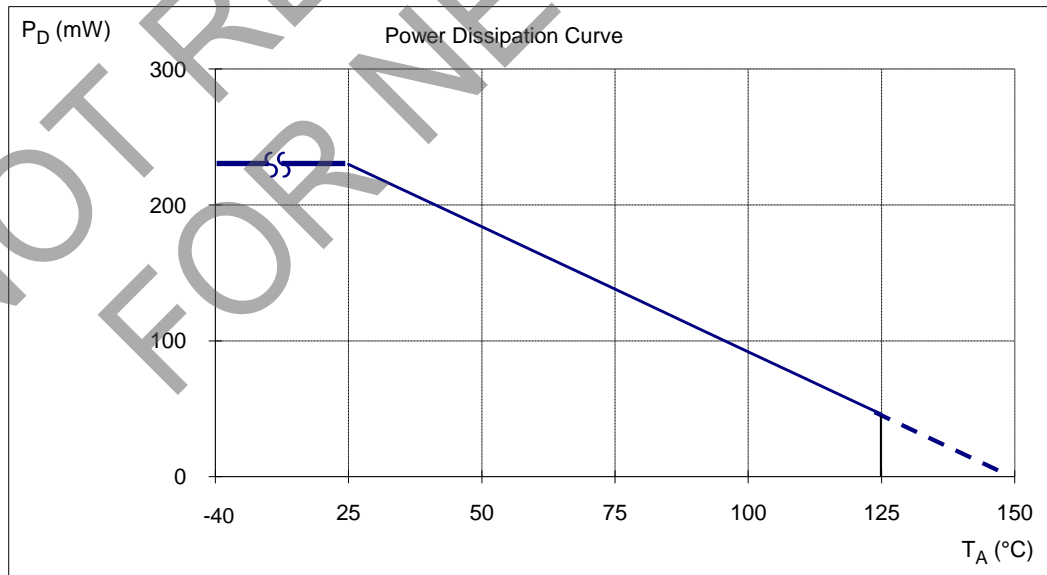

## Ordering Information

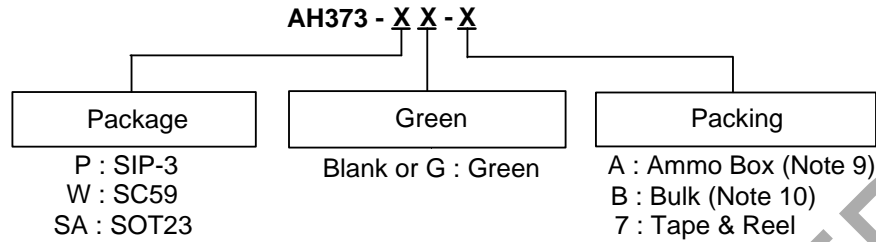

Part Number	Status (Note 11)	Package Code	Packaging (Note 12)	Bulk		7" Tape and Reel		Ammo Box	
				Quantity	Part Number Suffix	Quantity	Part Number Suffix	Quantity	Part Number Suffix
AH373-PG-A	NRND	P	SIP-3	NA	NA	NA	NA	4000/Box	-A
AH373-PG-B	NRND	P	SIP-3	1000	-B	NA	NA	NA	NA
AH373-WG-7	NRND	W	SC59	NA	NA	3000/Tape & Reel	-7	NA	NA
AH373-SA-7	NRND	SA	SOT23	NA	NA	3000/Tape & Reel	-7	NA	NA

- Notes:
- 9. Ammo Box is for SIP-3 Spread Lead.
  - 10. Bulk is for SIP-3 Straight Lead.
  - 11. NRND = Not Recommended for New Design
  - 12. Pad layout as shown on Diodes Incorporated's suggested pad layout document, which can be found on our website at <http://www.diodes.com/package-outlines.html>.

## Marking Information

### (1) Package Types: SC59 and SOT23

( Top View )

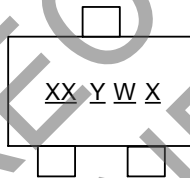

- XX** : Identification code
- Y** : Year 0 to 9
- W** : Week : A to Z : 1 to 26 week;  
a to z : 27 to 52 week; z represents 52 and 53 week
- X** : Internal Code: A ~ Z : Green  
a ~ z : Lead Free

Part Number	Package	Identification Code
AH373	SC59	P2
AH373	SOT23	S2

### (2) Package Type: SIP-3

( Top View )

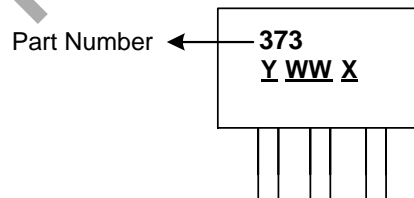

- Y** : Year : 0~9
- WW** : Week : 01~52, "52" represents 52 and 53 week
- X** : Internal Code: A ~ Z : Green  
a ~ z : Lead Free

Part Number	Package	Identification Code
AH373	SIP-3 (Ammo Pack)	373
AH373	SIP-3 (Bulk Pack)	373

**Package Outline Dimensions** (All dimensions in mm.)

Please see <http://www.diodes.com/package-outlines.html> for the latest version.

(1) Package Type: SC59

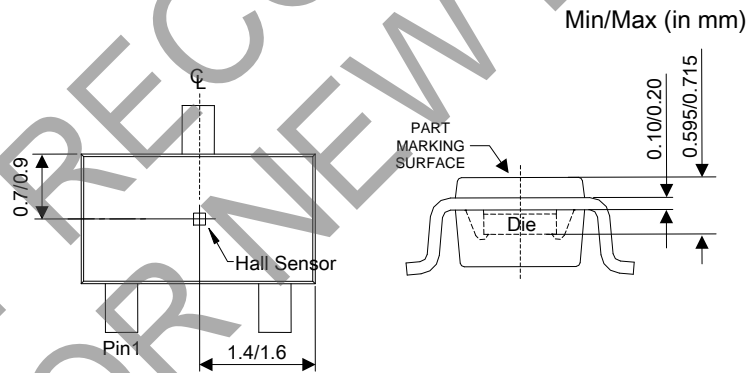
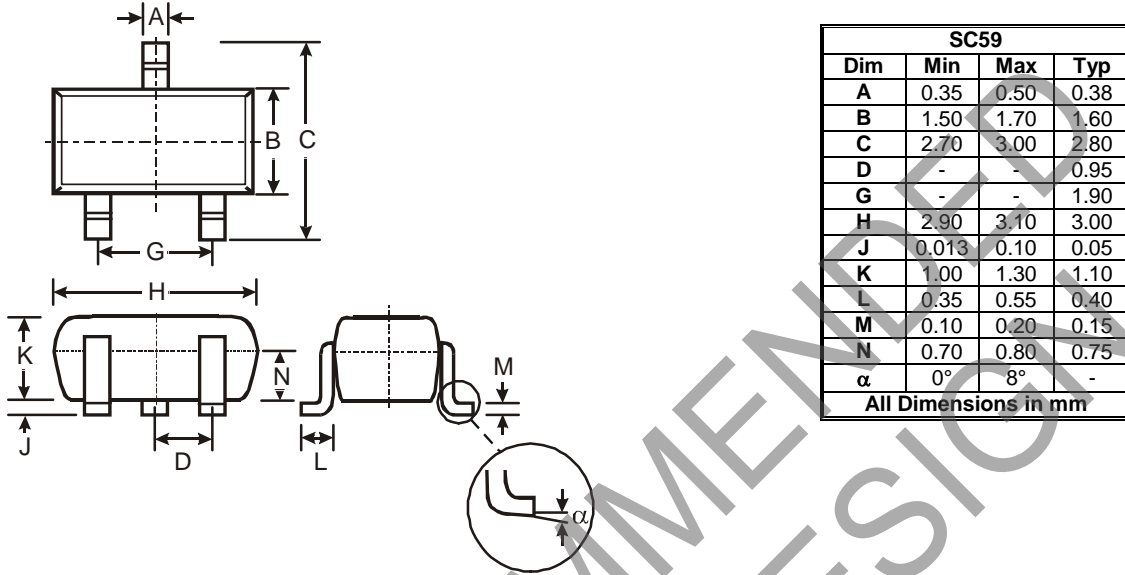

**Sensor Location**

**Package Outline Dimensions** (Cont.) (All dimensions in mm.)

Please see <http://www.diodes.com/package-outlines.html> for the latest version.

**(2) Package Type: SOT23**

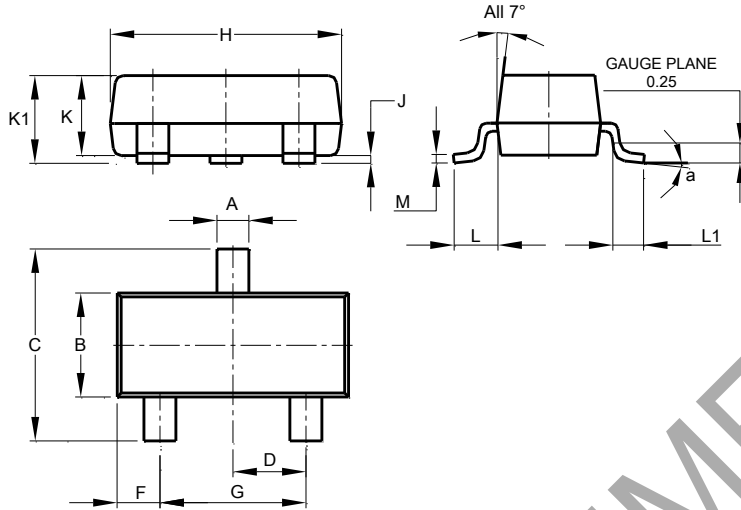

SOT23			
Dim	Min	Max	Typ
A	0.37	0.51	0.40
B	1.20	1.40	1.30
C	2.30	2.50	2.40
D	0.89	1.03	0.915
F	0.45	0.60	0.535
G	1.78	2.05	1.83
H	2.80	3.00	2.90
J	0.013	0.10	0.05
K	0.890	1.00	0.975
K1	0.903	1.10	1.025
L	0.45	0.61	0.55
L1	0.25	0.55	0.40
M	0.085	0.150	0.110
a	0°	8°	--
<b>All Dimensions in mm</b>			

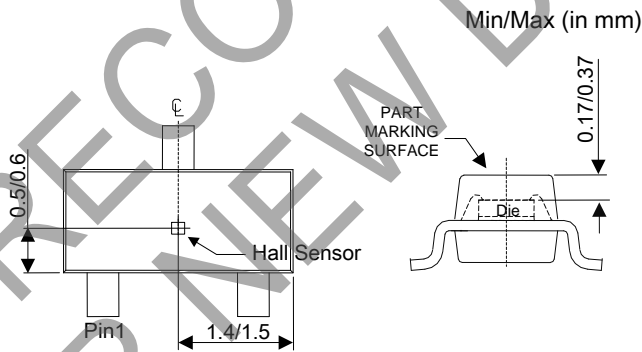

**Sensor Location**

**Package Outline Dimensions** (Cont.) (All dimensions in mm.)

Please see <http://www.diodes.com/package-outlines.html> for the latest version.

**(3) Package Type: SIP-3 (Bulk Pack)**

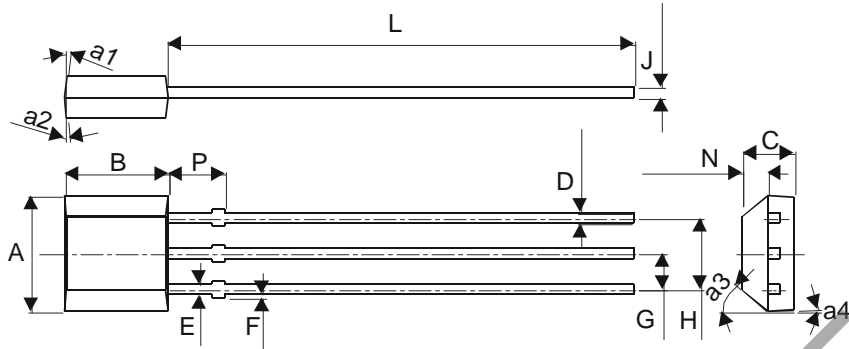

SIP-3 (Bulk Pack)		
Dim	Min	Max
A	3.9	4.3
a1	5° Typ	
a2	5° Typ	
a3	45° Typ	
a4	3° Typ	
B	2.8	3.2
C	1.40	1.60
D	0.33	0.432
E	0.40	0.508
F	0	0.2
G	1.24	1.30
H	2.51	2.57
J	0.35	0.43
L	14.0	15.0
N	0.63	0.84
P	1.55	-
<b>All Dimensions in mm</b>		

Notes: 12. SIP-3 (Bulk Pack) - Thickness J includes Burrs

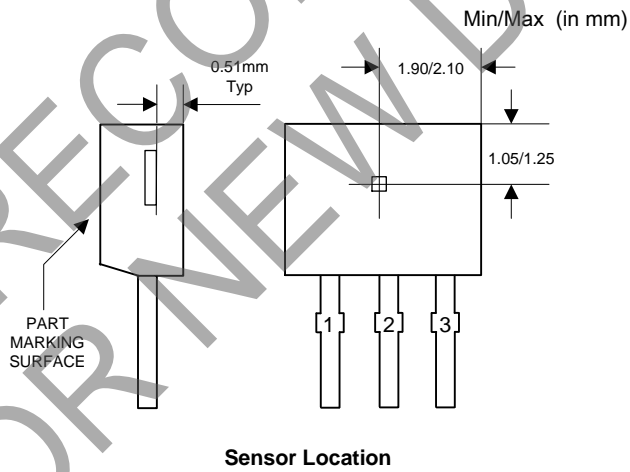

**Package Outline Dimensions** (Cont.) (All dimensions in mm.)

Please see <http://www.diodes.com/package-outlines.html> for the latest version.

**(4) Package Type: SIP-3 (Ammo Pack)**

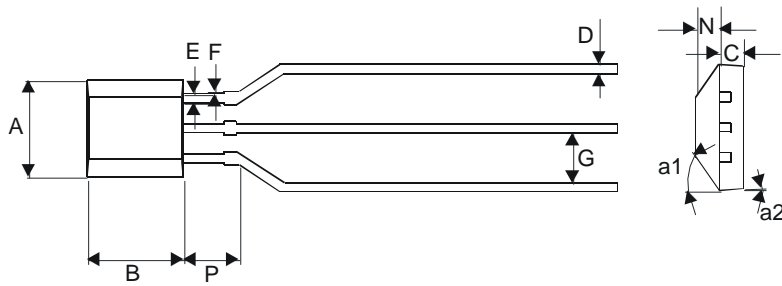

SIP-3 (Ammo Pack)		
Dim	Min	Max
A	3.9	4.3
a1	45° Typ	
a2	3° Typ	
B	2.8	3.2
C	1.40	1.60
D	0.35	0.41
E	0.43	0.48
F	0	0.2
G	2.4	2.9
N	0.63	0.84
P	1.55	-
<b>All Dimensions in mm</b>		

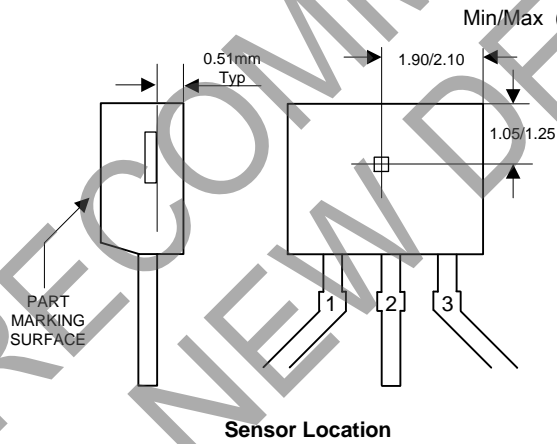

NOT RECOMMENDED FOR NEW DESIGN

**Suggested Pad Layout**

Please see <http://www.diodes.com/package-outlines.html> for the latest version.

**(1) Package Type: SC59**

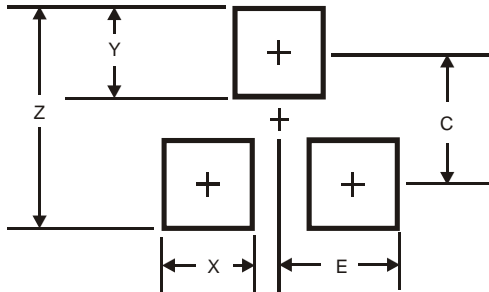

Dimensions	Value (in mm)
Z	3.4
X	0.8
Y	1.0
C	2.4
E	1.35

**(2) Package Type: SOT23**

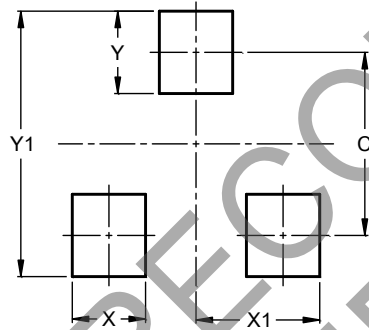

Dimensions	Value (in mm)
C	2.0
X	0.8
X1	1.35
Y	0.9
Y1	2.9

NOT RECOMMENDED FOR NEW DESIGN

#### IMPORTANT NOTICE

DIODES INCORPORATED MAKES NO WARRANTY OF ANY KIND, EXPRESS OR IMPLIED, WITH REGARDS TO THIS DOCUMENT, INCLUDING, BUT NOT LIMITED TO, THE IMPLIED WARRANTIES OF MERCHANTABILITY AND FITNESS FOR A PARTICULAR PURPOSE (AND THEIR EQUIVALENTS UNDER THE LAWS OF ANY JURISDICTION).

Diodes Incorporated and its subsidiaries reserve the right to make modifications, enhancements, improvements, corrections or other changes without further notice to this document and any product described herein. Diodes Incorporated does not assume any liability arising out of the application or use of this document or any product described herein; neither does Diodes Incorporated convey any license under its patent or trademark rights, nor the rights of others. Any Customer or user of this document or products described herein in such applications shall assume all risks of such use and will agree to hold Diodes Incorporated and all the companies whose products are represented on Diodes Incorporated website, harmless against all damages.

Diodes Incorporated does not warrant or accept any liability whatsoever in respect of any products purchased through unauthorized sales channel. Should Customers purchase or use Diodes Incorporated products for any unintended or unauthorized application, Customers shall indemnify and hold Diodes Incorporated and its representatives harmless against all claims, damages, expenses, and attorney fees arising out of, directly or indirectly, any claim of personal injury or death associated with such unintended or unauthorized application.

Products described herein may be covered by one or more United States, international or foreign patents pending. Product names and markings noted herein may also be covered by one or more United States, international or foreign trademarks.

This document is written in English but may be translated into multiple languages for reference. Only the English version of this document is the final and determinative format released by Diodes Incorporated.

#### LIFE SUPPORT

Diodes Incorporated products are specifically not authorized for use as critical components in life support devices or systems without the express written approval of the Chief Executive Officer of Diodes Incorporated. As used herein:

A. Life support devices or systems are devices or systems which:

1. are intended to implant into the body, or
2. support or sustain life and whose failure to perform when properly used in accordance with instructions for use provided in the labeling can be reasonably expected to result in significant injury to the user.

B. A critical component is any component in a life support device or system whose failure to perform can be reasonably expected to cause the failure of the life support device or to affect its safety or effectiveness.



Customers represent that they have all necessary expertise in the safety and regulatory ramifications of their life support devices or systems, and acknowledge and agree that they are solely responsible for all legal, regulatory and safety-related requirements concerning their products and any use of Diodes Incorporated products in such safety-critical, life support devices or systems, notwithstanding any devices- or systems-related information or support that may be provided by Diodes Incorporated. Further, Customers must fully indemnify Diodes Incorporated and its representatives against any damages arising out of the use of Diodes Incorporated products in such safety-critical, life support devices or systems.

Copyright © 2017, Diodes Incorporated

[www.diodes.com](http://www.diodes.com)

## Looking for pricing, stock, or lifecycle information?

Click below to explore more details on WIN SOURCE:

-  [View AH373-PG-A on WIN SOURCE](#)
-  [Diodes Incorporated Information](#)

## Optimize Your Supply Chain with WIN SOURCE Solutions

-  Global Sourcing Solution
-  Obsolete Management
-  Cost Control Management
-  Shortage Management
-  Alternative Solution
-  Excess Inventory Management