



**THE DATASHEET OF
IRF5803D2TR**



IRF5803D2

FETKY™ MOSFET & Schottky Diode

- Co-packaged HEXFET® Power MOSFET and Schottky Diode
- Ideal For Buck Regulator Applications
- P-Channel HEXFET®
- Low V_F Schottky Rectifier
- SO-8 Footprint

Description

The FETKY™ family of Co-packaged HEXFETs and Schottky diodes offer the designer an innovative board space saving solution for switching regulator and power management applications. HEXFETs utilize advanced processing techniques to achieve extremely low on-resistance per silicon area. Combining this technology with International Rectifier's low forward drop Schottky rectifiers results in an extremely efficient device suitable for use in a wide variety of portable electronics applications.

The SO-8 has been modified through a customized leadframe for enhanced thermal characteristics. The SO-8 package is designed for vapor phase, infrared or wave soldering techniques.

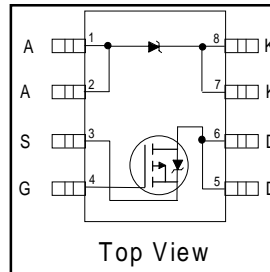

| |
|---------------------------|
| $V_{DSS} = -40V$ |
| $R_{DS(on)} = 112m\Omega$ |
| Schottky $V_f = 0.51V$ |

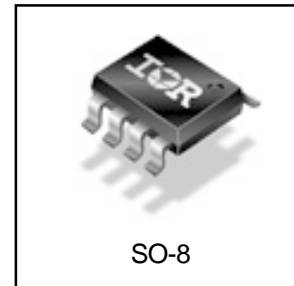

Absolute Maximum Ratings ($T_A = 25^\circ C$ Unless Otherwise Noted)

| Parameter | Maximum | Units |
|--------------------------|-------------|-------|
| $I_D @ T_A = 25^\circ C$ | -3.4 | A |
| $I_D @ T_A = 70^\circ C$ | -2.7 | |
| I_{DM} | -27 | |
| $P_D @ T_A = 25^\circ C$ | 2.0 | W |
| $P_D @ T_A = 70^\circ C$ | 1.3 | |
| | 16 | mW/°C |
| V_{GS} | ± 20 | V |
| T_J, T_{STG} | -55 to +150 | °C |

Thermal Resistance

| Symbol | Parameter | Typ. | Max. | Units |
|-----------------|---------------------------------|------|------|-------|
| $R_{\theta JL}$ | Junction-to-Drain Lead, MOSFET | — | 20 | °C/W |
| $R_{\theta JA}$ | Junction-to-Ambient ③, MOSFET | — | 62.5 | |
| $R_{\theta JA}$ | Junction-to-Ambient ③, SCHOTTKY | — | 62.5 | |

Notes:

- ① Repetitive rating – pulse width limited by max. junction temperature (see fig. 11)
- ② Pulse width $\leq 400\mu s$ – duty cycle $\leq 2\%$
- ③ Surface mounted on 1 inch square copper board, $t \leq 10sec.$

IRF5803D2

Electrical Characteristics @ T_J = 25°C (unless otherwise specified)

International
IR Rectifier

| | Parameter | Min. | Typ. | Max. | Units | Conditions |
|--|--------------------------------------|------|-------|------|-------|---|
| V _{(BR)DSS} | Drain-to-Source Breakdown Voltage | -40 | — | — | V | V _{GS} = 0V, I _D = -250μA |
| ΔV _{(BR)DSS} /ΔT _J | Breakdown Voltage Temp. Coefficient | — | -0.03 | — | V/°C | Reference to 25°C, I _D = -1mA |
| R _{DS(on)} | Static Drain-to-Source On-Resistance | — | — | 112 | mΩ | V _{GS} = -10V, I _D = -3.4A ② |
| | | — | — | 190 | | V _{GS} = -4.5V, I _D = -2.7A ② |
| V _{GS(th)} | Gate Threshold Voltage | -1.0 | — | -3.0 | V | V _{DS} = V _{GS} , I _D = -250μA |
| g _{fs} | Forward Transconductance | 4.0 | — | — | S | V _{DS} = -10V, I _D = -3.4A |
| I _{DSS} | Drain-to-Source Leakage Current | — | — | -10 | μA | V _{DS} = -32V, V _{GS} = 0V |
| | | — | — | -25 | | V _{DS} = -32V, V _{GS} = 0V, T _J = 70°C |
| I _{GSS} | Gate-to-Source Forward Leakage | — | — | -100 | nA | V _{GS} = -20V |
| | Gate-to-Source Reverse Leakage | — | — | 100 | | V _{GS} = 20V |
| Q _g | Total Gate Charge | — | 25 | 37 | nC | I _D = -3.4A |
| Q _{gs} | Gate-to-Source Charge | — | 4.5 | 6.8 | | V _{DS} = -20V |
| Q _{gd} | Gate-to-Drain ("Miller") Charge | — | 3.5 | 5.3 | | V _{GS} = -10V, See Fig. 6 & 14 ② |
| t _{d(on)} | Turn-On Delay Time | — | 43 | 65 | ns | V _{DD} = -20V |
| t _r | Rise Time | — | 550 | 825 | | I _D = -1.0A |
| t _{d(off)} | Turn-Off Delay Time | — | 88 | 130 | | R _G = 6.0Ω |
| t _f | Fall Time | — | 50 | 75 | | V _{GS} = -10V, ② |
| C _{iss} | Input Capacitance | — | 1110 | — | pF | V _{GS} = 0V |
| C _{oss} | Output Capacitance | — | 93 | — | | V _{DS} = -25V |
| C _{rss} | Reverse Transfer Capacitance | — | 73 | — | | f = 100kHz, See Fig. 5 |

MOSFET Source-Drain Ratings and Characteristics

| | Parameter | Min. | Typ. | Max. | Units | Conditions |
|-----------------|--|------|------|------|-------|---|
| I _S | Continuous Source Current (Body Diode) | — | — | -2.0 | A | |
| I _{SM} | Pulsed Source Current (Body Diode) | — | — | -27 | | |
| V _{SD} | Body Diode Forward Voltage | — | — | -1.2 | V | T _J = 25°C, I _S = -2.0A, V _{GS} = 0V |
| t _{rr} | Reverse Recovery Time (Body Diode) | — | 27 | 40 | ns | T _J = 25°C, I _F = -2.0A |
| Q _{rr} | Reverse Recovery Charge | — | 34 | 50 | nC | di/dt = 100A/μs ② |

Schottky Diode Maximum Ratings

| | Parameter | Max. | Units | Conditions |
|--------------------|--|------|-------|---|
| I _{f(av)} | Max. Average Forward Current | 3.0 | A | 50% Duty Cycle. Rectangular Waveform, T _A = 30°C See Fig.21 |
| I _{SM} | Max. peak one cycle Non-repetitive Surge current | 340 | A | 5μs sine or 3μs Rect. pulse |
| | | 70 | | 10ms sine or 6ms Rect. pulse |
| | | | | Following any rated load condition & with V _{rrm} applied |

Schottky Diode Electrical Specifications

| | Parameter | Max. | Units | Conditions |
|------------------|-----------------------------------|------|-------|---|
| V _{fm} | Max. Forward Voltage Drop | 0.51 | V | I _f = 5.0A, T _J = 25°C |
| | | 0.63 | | I _f = 10A, T _J = 25°C |
| | | 0.44 | | I _f = 5.0A, T _J = 125°C |
| | | 0.59 | | I _f = 10A, T _J = 125°C |
| V _{rrm} | Max. Working Peak Reverse Voltage | 40 | V | |
| I _{rm} | Max. Reverse Leakage Current | 3.0 | mA | V _r = 40V, T _J = 25°C |
| | | 37 | | T _J = 125°C |
| C _t | Max. Junction Capacitance | 405 | pF | V _r = 5Vdc (100kHz to 1 MHz) 25°C |

Power Mosfet Characteristics

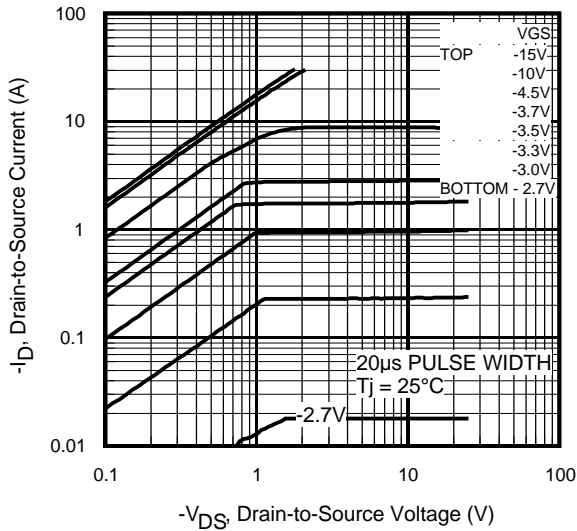

Fig 1. Typical Output Characteristics

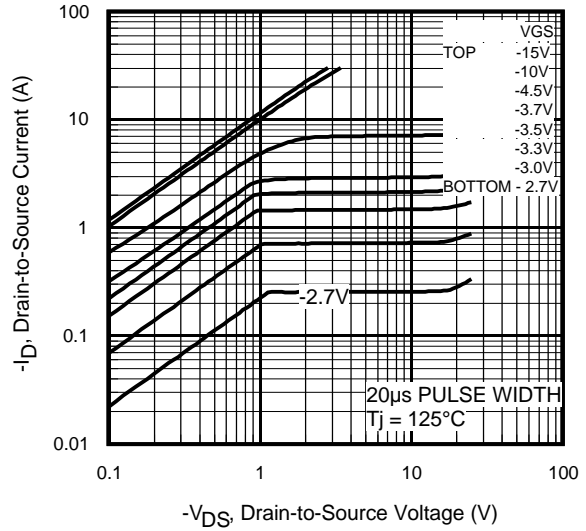

Fig 2. Typical Output Characteristics

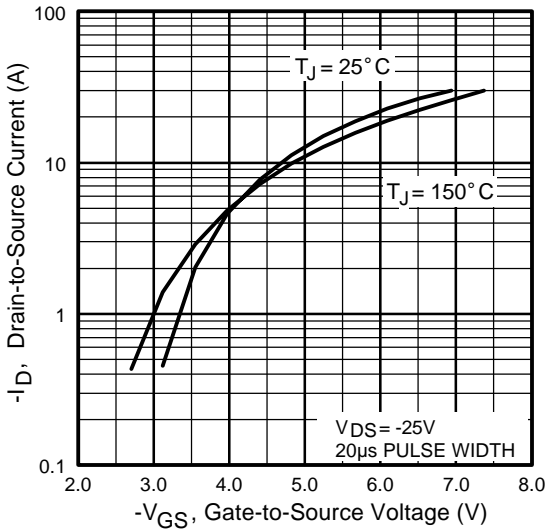

Fig 3. Typical Transfer Characteristics

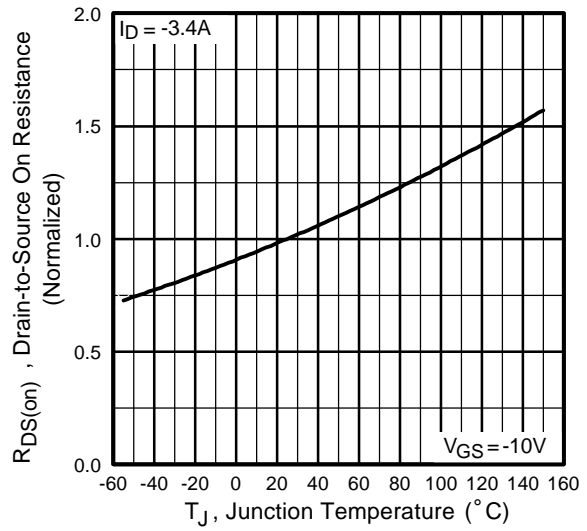

Fig 4. Normalized On-Resistance Vs. Temperature

Power Mosfet Characteristics

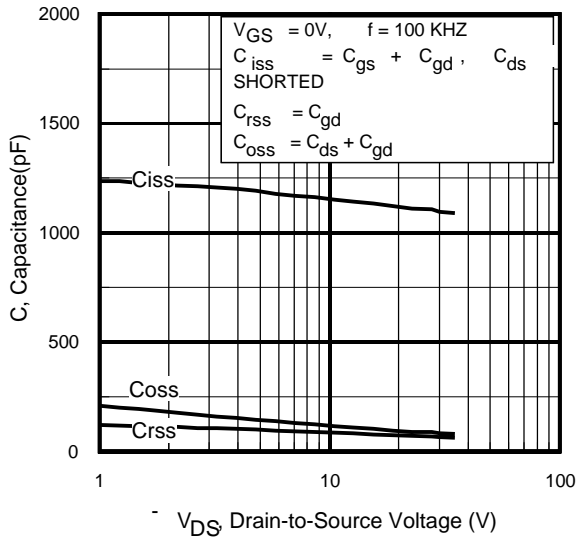

Fig 5. Typical Capacitance Vs. Drain-to-Source Voltage

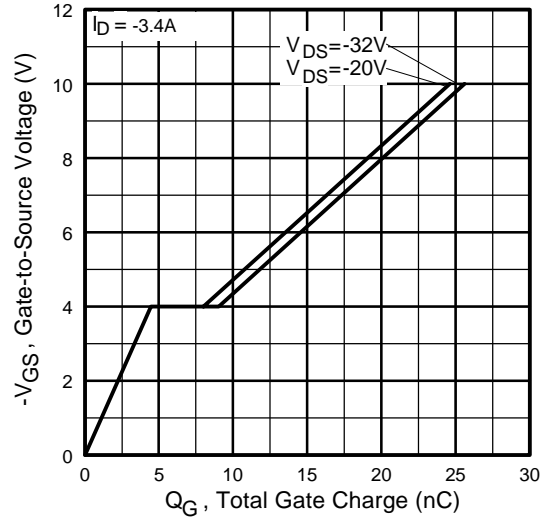

Fig 6. Typical Gate Charge Vs. Gate-to-Source Voltage

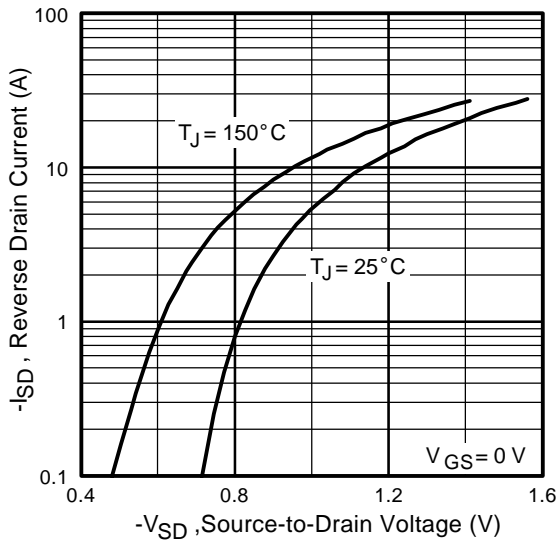

Fig 7. Typical Source-Drain Diode Forward Voltage

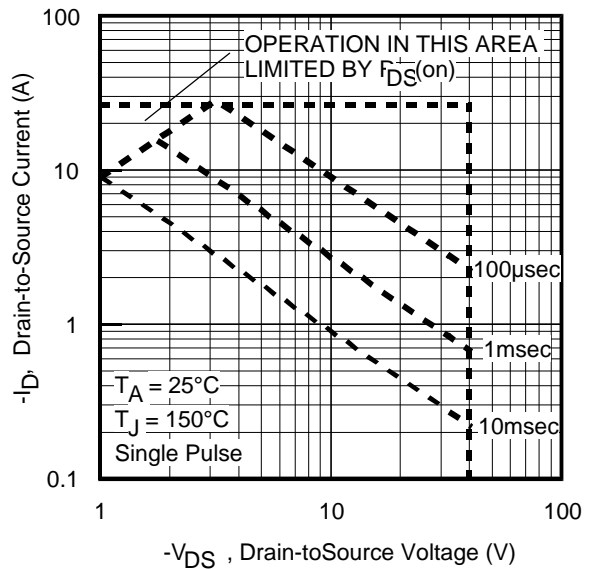

Fig 8. Maximum Safe Operating Area

Power Mosfet Characteristics

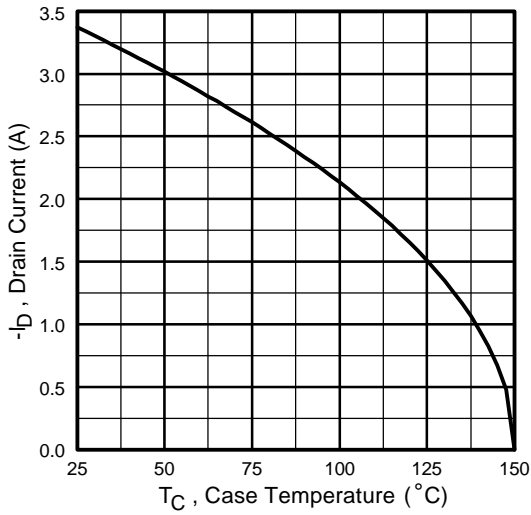

Fig 9. Maximum Drain Current Vs. Case Temperature

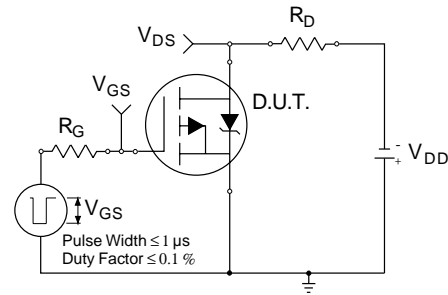

Fig 10a. Switching Time Test Circuit

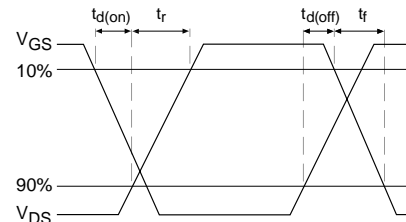

Fig 10b. Switching Time Waveforms

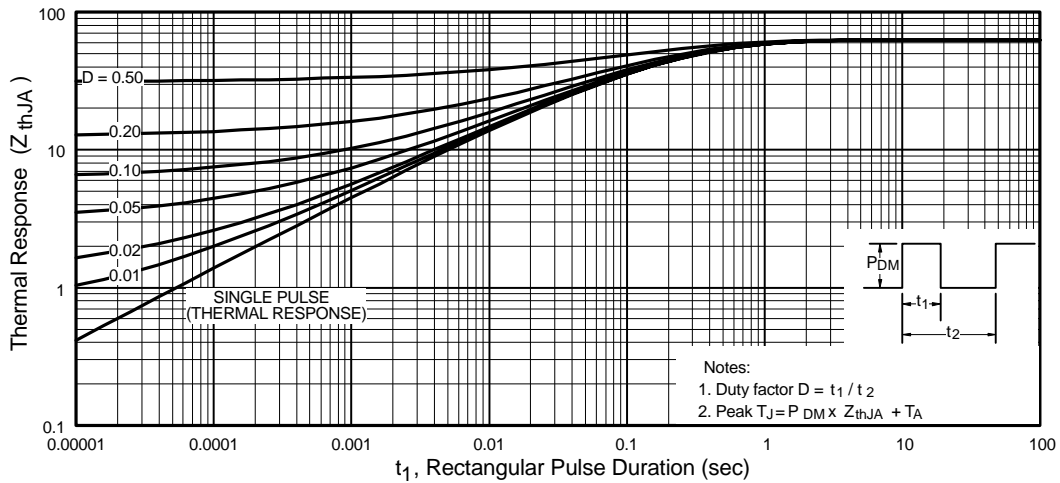

Fig 11. Maximum Effective Transient Thermal Impedance, Junction-to-Ambient

Power Mosfet Characteristics

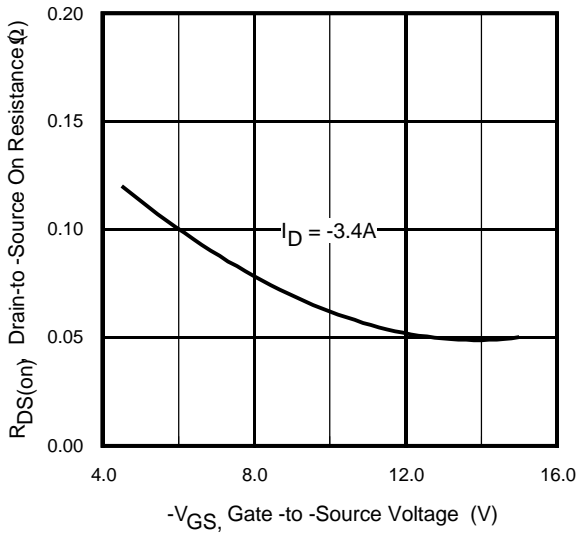

Fig 12. Typical On-Resistance Vs. Gate Voltage

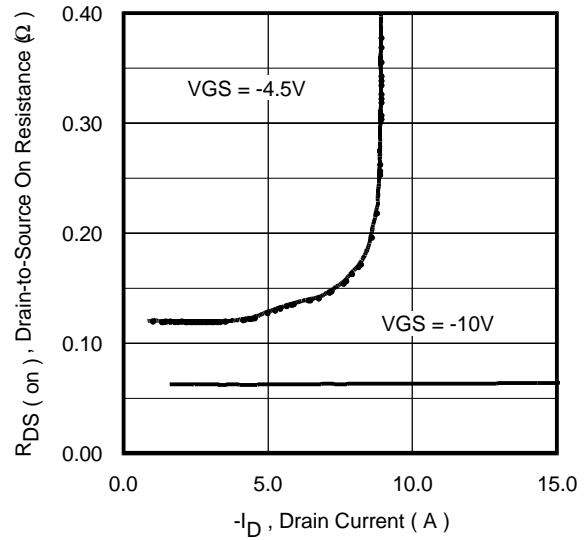

Fig 13. Typical On-Resistance Vs. Drain Current

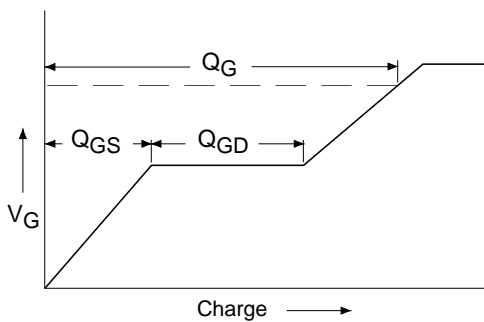

Fig 14a. Basic Gate Charge Waveform

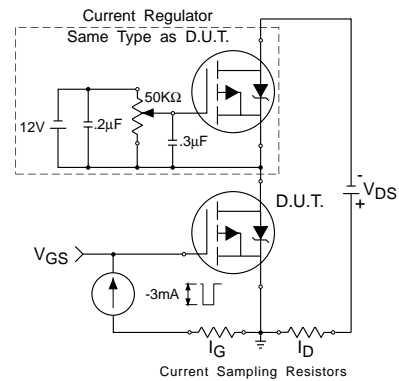

Fig 14b. Gate Charge Test Circuit

Power Mosfet Characteristics

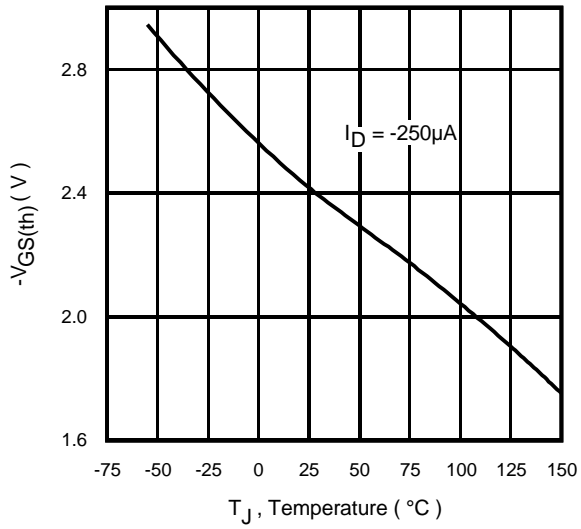

Fig 15. Typical $V_{GS(th)}$ Vs. Junction Temperature

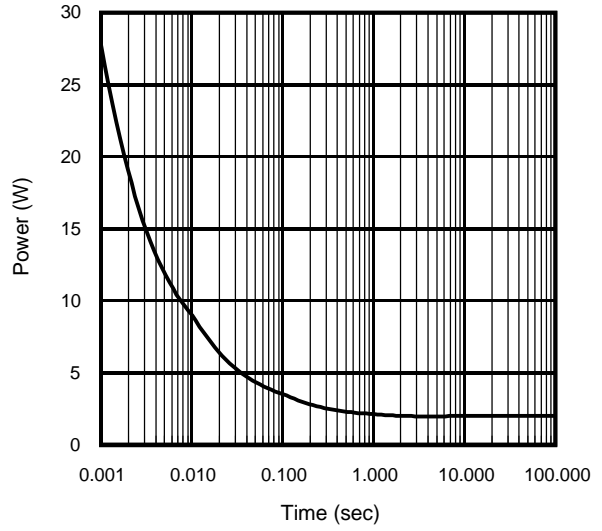

Fig 16. Typical Power Vs. Time

Schottky Diode Characteristics

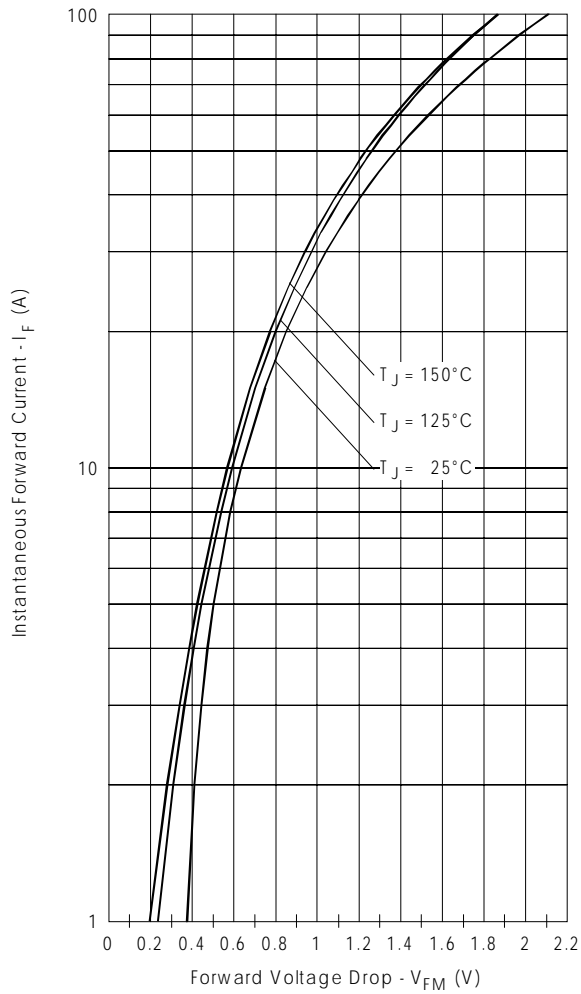

Fig. 17 - Maximum Forward Voltage Drop Characteristics

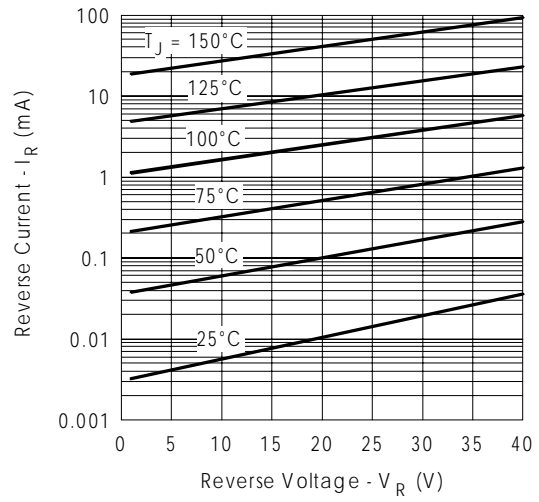

Fig. 18 - Typical Values of Reverse Current Vs. Reverse Voltage

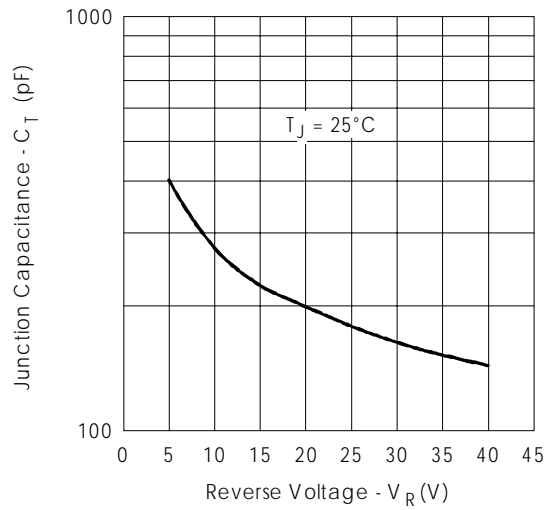

Fig. 19 - Typical Junction Capacitance Vs. Reverse Voltage

Schottky Diode Characteristics

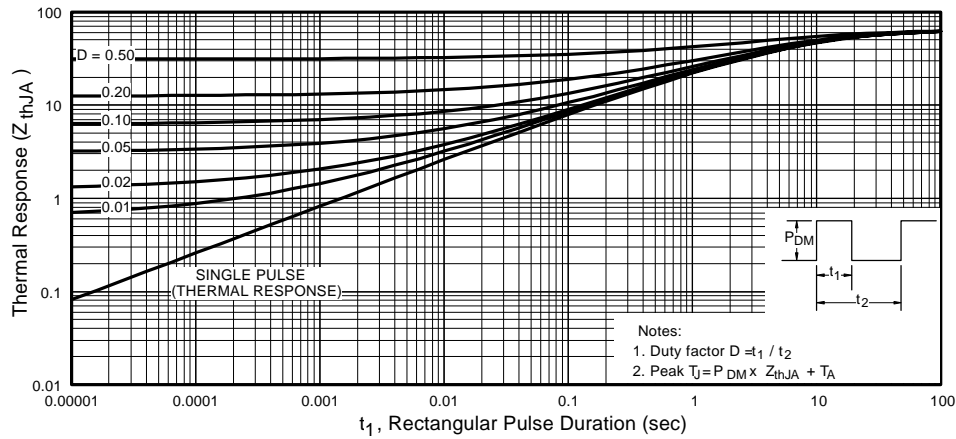

Fig 20. Maximum Effective Transient Thermal Impedance, Junction-to-Ambient

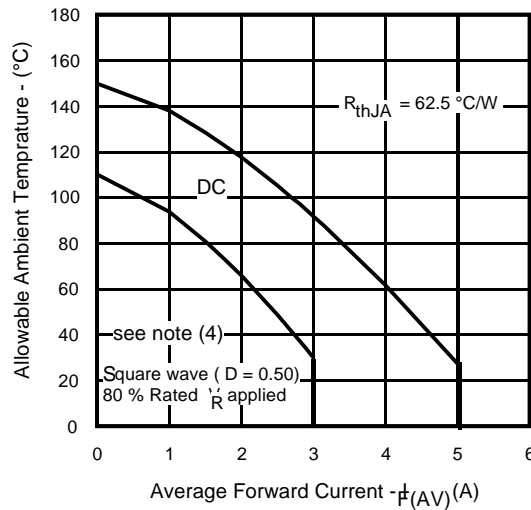

Fig.21 - Maximum Allowable Ambient Temp. Vs. Forward Current

Note (4) Formula used: $T_C = T_J - (P_d + P_{d_{REV}}) \times R_{thJA}$;
 $P_d = \text{Forward Power Loss} = I_{F(AV)} \times V_{FM} @ (I_{F(AV)} / D)$;
 $P_{d_{REV}} = \text{Inverse Power Loss} = V_{R1} \times I_R (1 - D)$; $I_R @ V_{R1} = 80\% \text{ rated } V_R$
www.irf.com

IRF5803D2

International
IR Rectifier

SO-8 Package Details

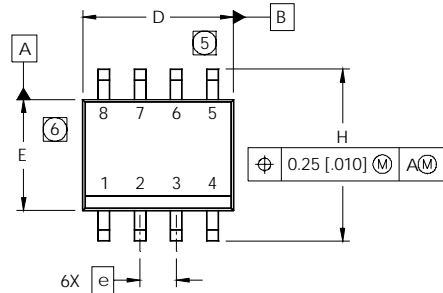

| DIM | INCHES | | MILLIMETERS | |
|-----|------------|-------|-------------|------|
| | MIN | MAX | MIN | MAX |
| A | .0532 | .0688 | 1.35 | 1.75 |
| A1 | .0040 | .0098 | 0.10 | 0.25 |
| b | .013 | .020 | 0.33 | 0.51 |
| c | .0075 | .0098 | 0.19 | 0.25 |
| D | .189 | .1968 | 4.80 | 5.00 |
| E | .1497 | .1574 | 3.80 | 4.00 |
| e | .050 BASIC | | 1.27 BASIC | |
| e1 | .025 BASIC | | 0.635 BASIC | |
| H | .2284 | .2440 | 5.80 | 6.20 |
| K | .0099 | .0196 | 0.25 | 0.50 |
| L | .016 | .050 | 0.40 | 1.27 |
| y | 0° | 8° | 0° | 8° |

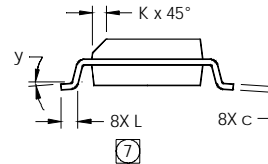
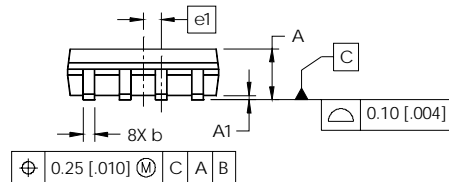

NOTES:

1. DIMENSIONING & TOLERANCING PER ASME Y14.5M-1994.
2. CONTROLLING DIMENSION: MILLIMETER
3. DIMENSIONS ARE SHOWN IN MILLIMETERS [INCHES].
4. OUTLINE CONFORMS TO JEDEC OUTLINE MS-012AA.
- 5 DIMENSION DOES NOT INCLUDE MOLD PROTRUSIONS. MOLD PROTRUSIONS NOT TO EXCEED 0.15 [0.006].
- 6 DIMENSION DOES NOT INCLUDE MOLD PROTRUSIONS. MOLD PROTRUSIONS NOT TO EXCEED 0.25 [0.010].
- 7 DIMENSION IS THE LENGTH OF LEAD FOR SOLDERING TO A SUBSTRATE.

FOOTPRINT

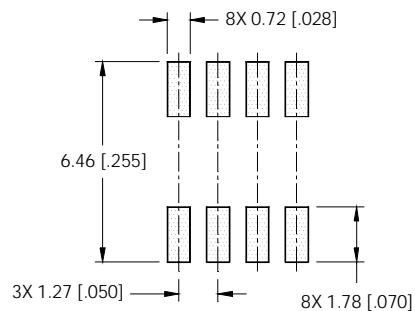

SO-8 Part Marking

EXAMPLE: THIS IS AN IRF7101 (MOSFET)

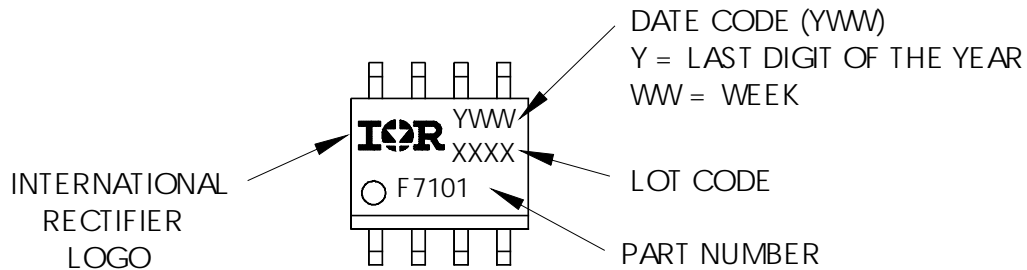

SO-8 Tape and Reel

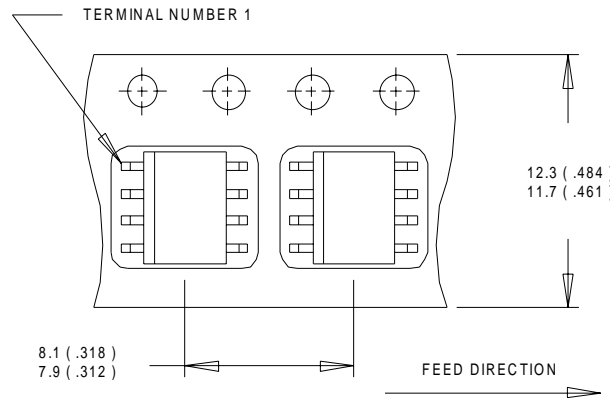

- NOTES:
1. CONTROLLING DIMENSION : MILLIMETER.
 2. ALL DIMENSIONS ARE SHOWN IN MILLIMETERS(INCHES).
 3. OUTLINE CONFORMS TO EIA-481 & EIA-541.

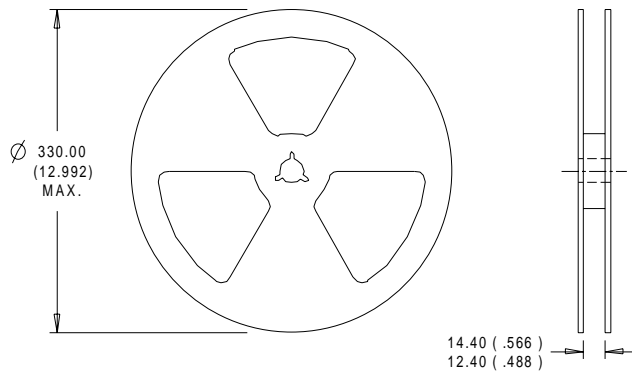

- NOTES :
1. CONTROLLING DIMENSION : MILLIMETER.
 2. OUTLINE CONFORMS TO EIA-481 & EIA-541.

Data and specifications subject to change without notice.
 This product has been designed and qualified for the consumer market.
 Qualification Standards can be found on IR's Web site.

Looking for pricing, stock, or lifecycle information?

Click below to explore more details on WIN SOURCE:

-  [View IRF5803D2TR on WIN SOURCE](#)
-  [Infineon Technologies](#) Information

Optimize Your Supply Chain with WIN SOURCE Solutions

-  Global Sourcing Solution
-  Obsolete Management
-  Cost Control Management
-  Shortage Management
-  Alternative Solution
-  Excess Inventory Management