



**THE DATASHEET OF
LD2982AM47R**





LD2982BXX18

Very low drop and low noise voltage regulator with inhibit function, low ESR capacitors compatible

Features

- Very low dropout voltage (120 mV at 50 mA and 7 mV at 1 mA load)
- Very low quiescent current (375 mA typ. at 50 mA load and 75 mA at 1 mA)
- Output current up to 50 mA
- Logic controlled electronic shutdown
- Output voltage of 1.8 V
- Internal current and thermal limit
- Available in $\pm 1\%$ tolerance (at 25 °C, A version)
- Supply voltage rejection: 45 dB (typ)
- Only 1 μ F for stability
- Low output noise voltage 30 μ Vrms
- Smallest package SOT23-5L
- Temperature range: -40 °C to 125 °C

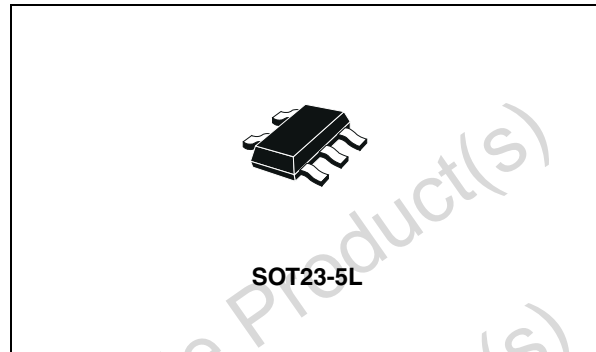

Typical application are in cellular phone, palmtop/laptop computer, personal digital assistant (PDA), personal stereo, camcorder and camera.

Description

The LD2982 is a 50 mA fixed output voltage regulator. The ultra low drop voltage and the low quiescent current make them particularly suitable for low noise, low power applications, and in battery powered systems. In sleep mode quiescent current is less than 1 μ A when INHIBIT pin is pulled low. Shutdown logic control function is available on pin 3 (TTL compatible). This means that when the device is used as local regulator, it is possible to put a part of the board in standby, decreasing the total power consumption.

An external capacitor $C_{BYP} = 10$ nF connected between bypass pin and GND reduce the noise to 30 μ Vrms.

Table 1. Device summary

Order code	Output voltage
LD2982BM18R	1.8 V

Contents

1	Diagram	3
2	Pin configuration	4
3	Maximum ratings	5
4	Electrical characteristics	6
5	Typical characteristics	8
6	Application notes	11
6.1	External capacitors	11
6.2	Input capacitor	11
6.3	Output capacitor	11
6.4	Important	11
6.5	Inhibit input operation	11
6.6	Reverse current	12
7	Package mechanical data	13
8	Revision history	16

1 Diagram

Figure 1. Schematic diagram

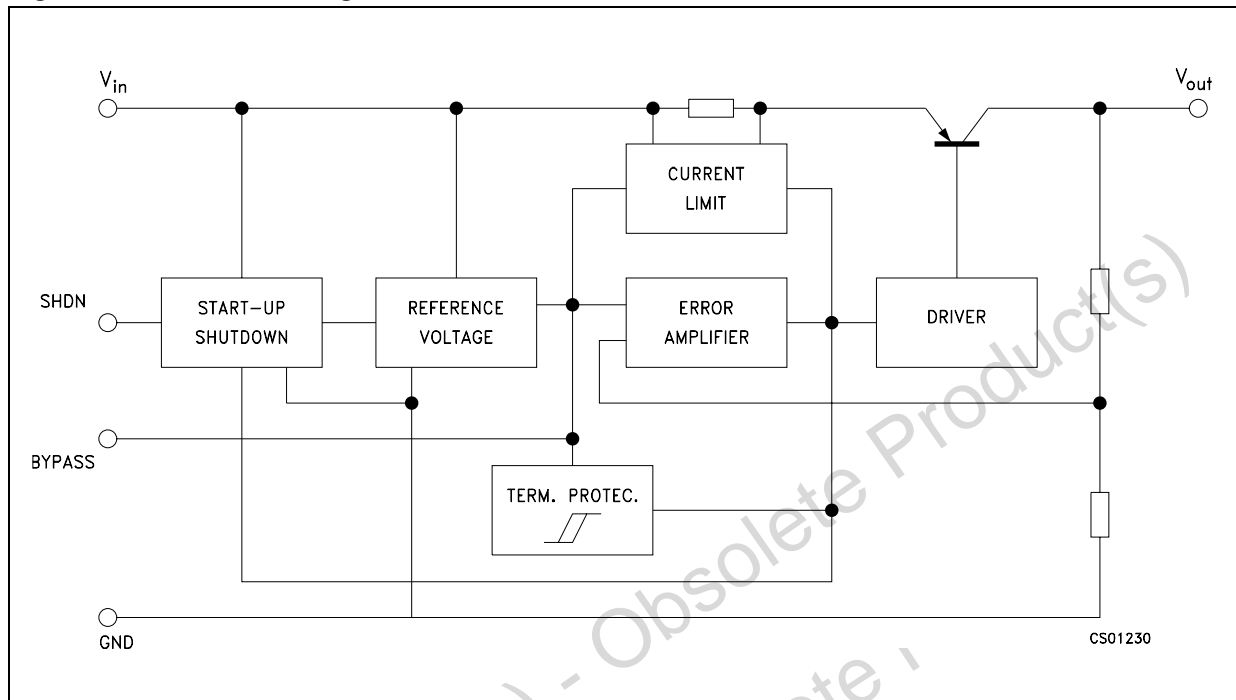

2 Pin configuration

Figure 2. Pin connections (top view)

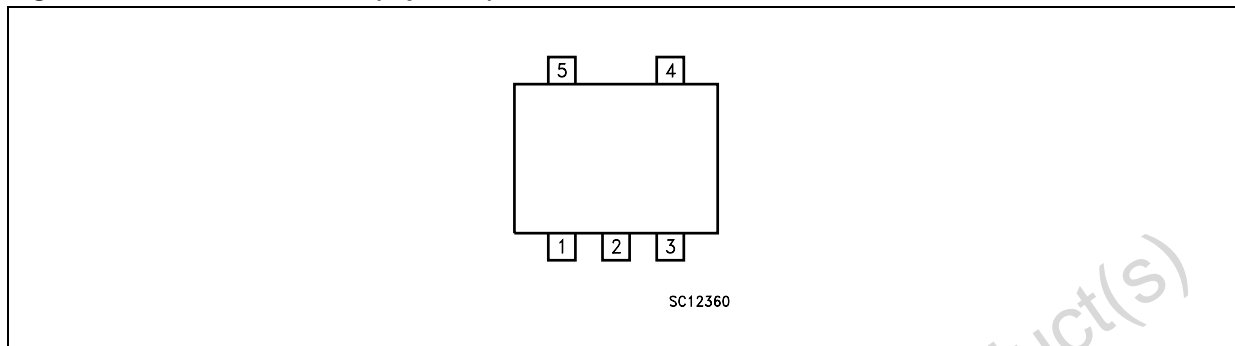

Table 2. Pin description

Pin n°	Symbol	Name and function
1	IN	Input port
2	GND	Ground pin
3	INHIBIT	Control switch ON/OFF. Inhibit is not internally pulled-up; it cannot be left floating. Disable the device when connected to GND or to a positive voltage less than 0.18V
4	Bypass	Bypass Pin: Capacitor to be connected to GND in order to improve the thermal noise performances
5	OUT	Output port

Table 3. Thermal data

Symbol	Parameter	SOT23-5L	Unit
R_{thJC}	Thermal resistance junction-case	81	°C/W
R_{thJA}	Thermal resistance junction-ambient	255	°C/W

3 Maximum ratings

Table 4. Absolute maximum ratings

Symbol	Parameter	Value	Unit
V_I	DC input voltage	16	V
V_{INH}	INHIBIT input voltage	16	V
I_O	Output current	Internally limited	
P_D	Power dissipation	Internally limited	
T_{STG}	Storage temperature range	-65 to 150	°C
T_{OP}	Operating junction temperature range	-40 to 125	°C

Note: Absolute maximum ratings are those values beyond which damage to the device may occur. Functional operation under these condition is not implied.

4 Electrical characteristics

$T_J = 25\text{ }^\circ\text{C}$, $V_I = V_O + 1\text{ V}$, $I_O = 1\text{ mA}$, $V_{\text{SHDN}} = 2\text{ V}$, $C_I = C_O = 1\text{ }\mu\text{F}$, unless otherwise specified.

Table 5. Electrical characteristics for LD2982BXX18

Symbol	Parameter	Test conditions	Min.	Typ.	Max.	Unit
V_{OP}	Operating input voltage		2.5		16	V
V_O	Output voltage	$V_I = 2.5\text{V}$	1.477	1.5	1.523	V
		$I_O = 1\text{ to }50\text{mA}$	1.470		1.530	
		$I_O = 1\text{ to }50\text{mA}$, $T_J = -40\text{ to }125\text{ }^\circ\text{C}$	1.447		1.553	
V_O	Output voltage	$V_I = 2.8\text{V}$	1.773	1.8	1.827	V
		$I_O = 1\text{ to }50\text{mA}$	1.764		1.836	
		$I_O = 1\text{ to }50\text{mA}$, $T_J = -40\text{ to }125\text{ }^\circ\text{C}$	1.737		1.863	
V_O	Output voltage	$V_I = 3.5\text{V}$	2.462	2.5	2.537	V
		$I_O = 1\text{ to }50\text{mA}$	2.45		2.55	
		$I_O = 1\text{ to }50\text{mA}$, $T_J = -40\text{ to }125\text{ }^\circ\text{C}$	2.412		2.587	
V_O	Output voltage	$V_I = 3.8\text{V}$	2.758	2.8	2.842	V
		$I_O = 1\text{ to }50\text{mA}$	2.744		2.856	
		$I_O = 1\text{ to }50\text{mA}$, $T_J = -40\text{ to }125\text{ }^\circ\text{C}$	2.702		2.898	
V_O	Output voltage	$V_I = 3.85\text{V}$	2.807	2.85	2.893	V
		$I_O = 1\text{ to }50\text{mA}$	2.793		2.907	
		$I_O = 1\text{ to }50\text{mA}$, $T_J = -40\text{ to }125\text{ }^\circ\text{C}$	2.750		2.950	
V_O	Output voltage	$V_I = 4.0\text{V}$	2.955	3.0	3.045	V
		$I_O = 1\text{ to }50\text{mA}$	2.94		3.06	
		$I_O = 1\text{ to }50\text{mA}$, $T_J = -40\text{ to }125\text{ }^\circ\text{C}$	2.895		3.105	
V_O	Output voltage	$V_I = 4.1\text{V}$	3.053	3.1	3.146	V
		$I_O = 1\text{ to }50\text{mA}$	3.038		3.162	
		$I_O = 1\text{ to }50\text{mA}$, $T_J = -40\text{ to }125\text{ }^\circ\text{C}$	2.991		3.208	
V_O	Output voltage	$V_I = 4.2\text{V}$	3.152	3.2	3.248	V
		$I_O = 1\text{ to }50\text{mA}$	3.136		3.264	
		$I_O = 1\text{ to }50\text{mA}$, $T_J = -40\text{ to }125\text{ }^\circ\text{C}$	3.088		3.312	
V_O	Output voltage	$V_I = 4.3\text{V}$	3.250	3.3	3.349	V
		$I_O = 1\text{ to }50\text{mA}$	3.234		3.366	
		$I_O = 1\text{ to }50\text{mA}$, $T_J = -40\text{ to }125\text{ }^\circ\text{C}$	3.184		3.415	
V_O	Output voltage	$V_I = 4.5\text{V}$	3.447	3.5	3.552	V
		$I_O = 1\text{ to }50\text{mA}$	3.430		3.370	
		$I_O = 1\text{ to }50\text{mA}$, $T_J = -40\text{ to }125\text{ }^\circ\text{C}$	3.377		3.662	
V_O	Output voltage	$V_I = 4.6\text{V}$	3.546	3.6	3.654	V
		$I_O = 1\text{ to }50\text{mA}$	3.528		3.672	
		$I_O = 1\text{ to }50\text{mA}$, $T_J = -40\text{ to }125\text{ }^\circ\text{C}$	3.474		3.726	

Table 5. Electrical characteristics for LD2982BXX18 (continued)

Symbol	Parameter	Test conditions	Min.	Typ.	Max.	Unit
V_O	Output voltage	$V_I = 4.8V$	3.743	3.8	3.857	V
		$I_O = 1$ to 50mA	3.724		3.876	
		$I_O = 1$ to 50mA, $T_J = -40$ to 125°C	3.667		3.933	
V_O	Output voltage	$V_I = 5.0V$	3.94	4	4.06	V
		$I_O = 1$ to 50mA	3.92		4.08	
		$I_O = 1$ to 50mA, $T_J = -40$ to 125°C	3.86		4.14	
V_O	Output voltage	$V_I = 5.7V$	4.629	4.7	4.77	V
		$I_O = 1$ to 50mA	4.606		4.794	
		$I_O = 1$ to 50mA, $T_J = -40$ to 125°C	4.535		4.864	
V_O	Output voltage	$V_I = 6.0V$	4.925	5	5.075	V
		$I_O = 1$ to 50mA	4.9		5.1	
		$I_O = 1$ to 100 mA, $T_J = -40$ to 125°C	4.825		5.175	
I_{SC}	Short circuit current	$R_L = 0$		400		mA
$\Delta V_O / \Delta V_I$	Line regulation	$V_I = V_O + 1V$ to 16V, $I_O = 1$ mA		0.003	0.014	%/ V_I
		$V_I = V_O + 1V$ to 16V, $I_O = 1$ mA, $T_J = -40$ to 125°C			0.032	
V_{DROD}	Dropout voltage	$I_O = 0$		1	3	mV
		$I_O = 0$, $T_J = -40$ to 125°C			5	
		$I_O = 1$ mA		7	10	
		$I_O = 1$ mA, $T_J = -40$ to 125°C			15	
		$I_O = 10$ mA		40	60	
		$I_O = 10$ mA, $T_J = -40$ to 125°C			90	
		$I_O = 50$ mA		120	150	
		$I_O = 50$ mA, $T_J = -40$ to 125°C			225	
I_Q	Quiescent current ON MODE	$I_O = 0$		80	100	μA
		$I_O = 0$, $T_J = -40$ to 125°C			150	
		$I_O = 1$ mA		100	150	
		$I_O = 1$ mA, $T_J = -40$ to 125°C			200	
		$I_O = 10$ mA		200	300	
		$I_O = 10$ mA, $T_J = -40$ to 125°C			400	
		$I_O = 50$ mA		600	900	
		$I_O = 50$ mA, $T_J = -40$ to 125°C			1200	
	OFF MODE	$V_{INH} < 0.18V$		0		
		$V_{INH} < 0.18V$, $T_J = -40$ to 125°C			1	
SVR	Supply voltage rejection	$C_{BYP} = 0.01\mu F$, $C_O = 10\mu F$, $f = 1$ kHz		45		dB
V_{IL}	Inhibit input logic low	$T_J = -40$ to 125°C			0.15	V
V_{IH}	Inhibit input logic high	$T_J = -40$ to 125°C	2			V
I_{INH}	Inhibit input current	$V_{INH} = 0V$, $T_J = -40$ to 125°C		5	15	μA
		$V_{INH} = 5V$, $T_J = -40$ to 125°C		0	-1	
e_N	Output noise voltage	$B = 300$ Hz to 50 kHz, $C_{BYP} = 0.01\mu F$, $C_O = 10\mu F$		30		μV

5 Typical characteristics

($T_J = 25\text{ }^\circ\text{C}$, $V_I = V_{O(NOM)} + 1\text{ V}$, $C_I = 1\text{ }\mu\text{F}$ (X7R), $C_O = 2.2\text{ }\mu\text{F}$ (X7R), $V_{INH} = 2\text{ V}$, unless otherwise specified).

Figure 3. Output voltage vs. temperature

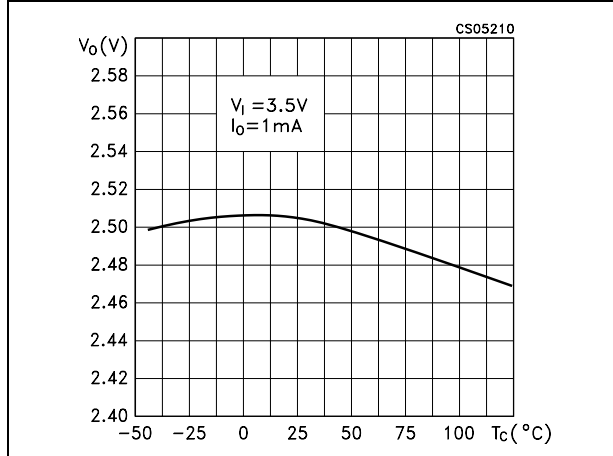

Figure 4. Dropout voltage vs. temperature

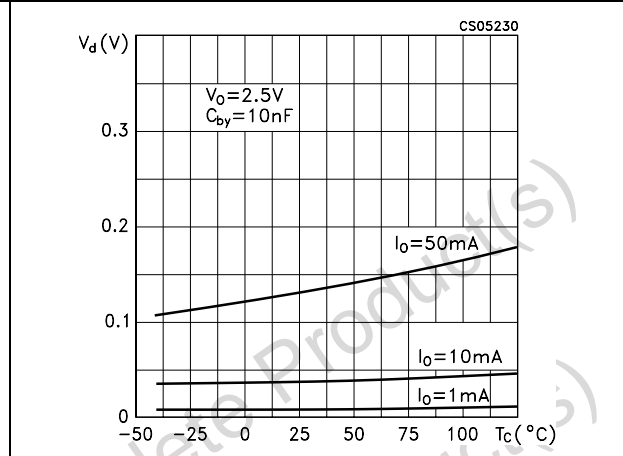

Figure 5. Dropout voltage vs. output current

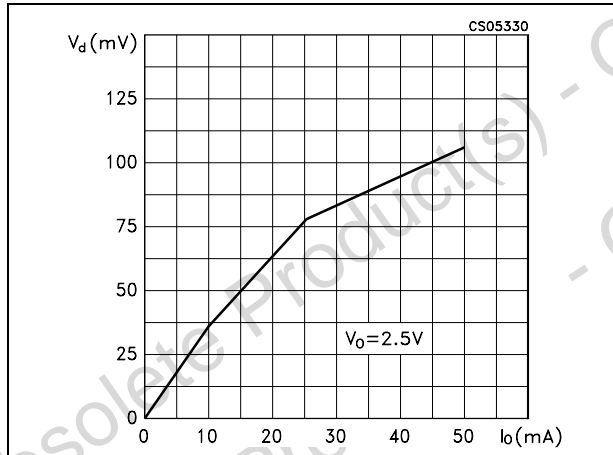

Figure 6. Quiescent current vs. load current

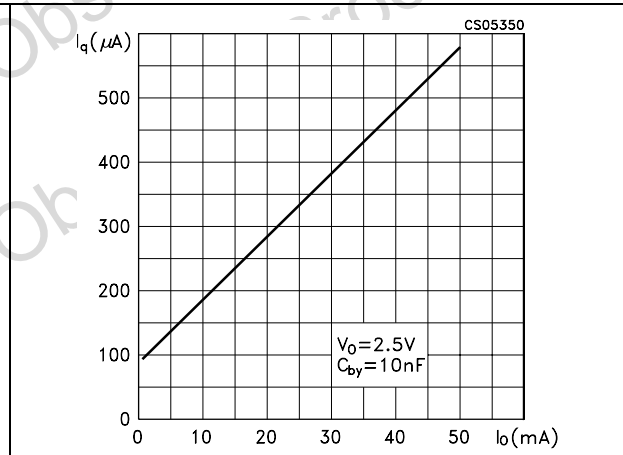

Figure 7. Quiescent current vs. temperature

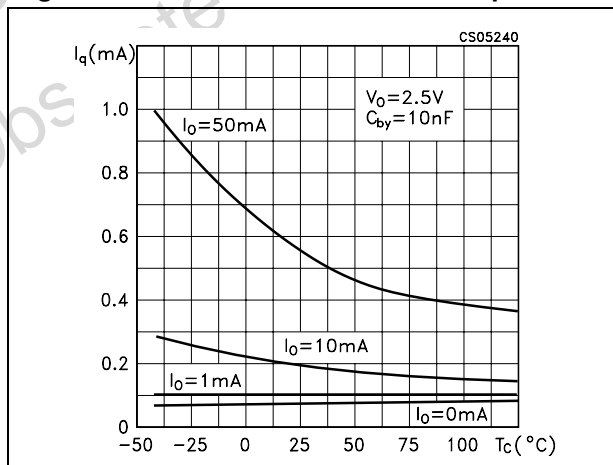

Figure 8. Supply voltage rejection vs. temp.

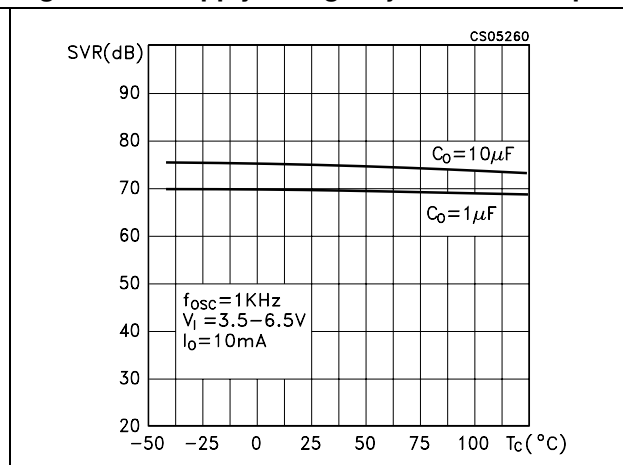

Figure 9. Supply voltage rejection vs. output current

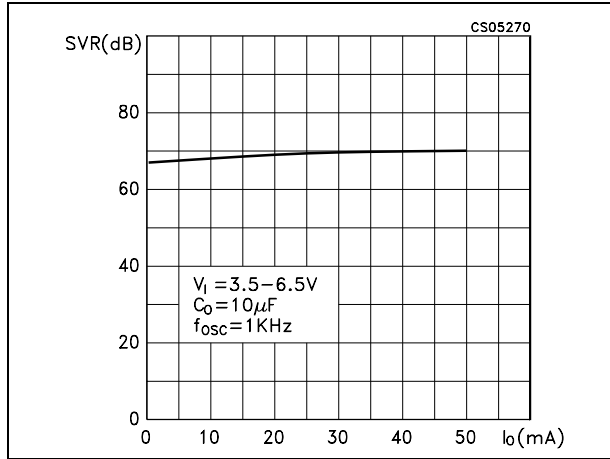

Figure 10. Supply voltage rejection vs. output current

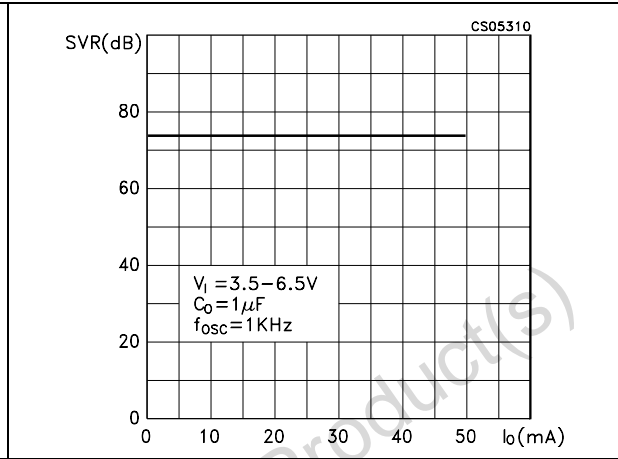

Figure 11. Supply voltage rejection vs. frequency

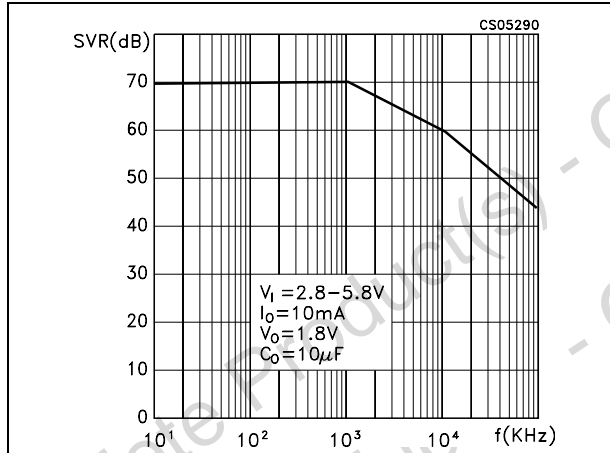

Figure 12. Supply voltage rejection vs. frequency

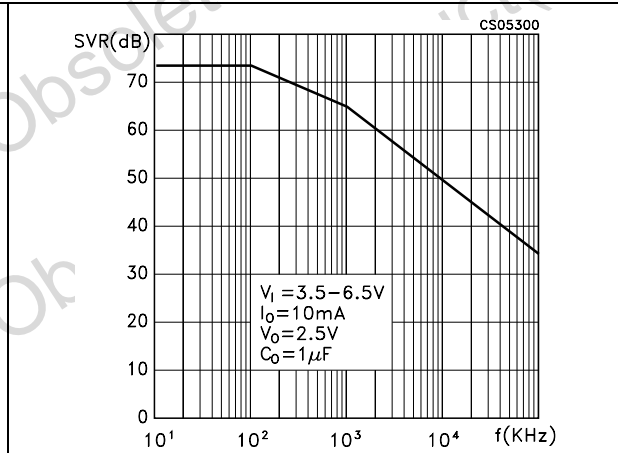

Figure 13. Line transient

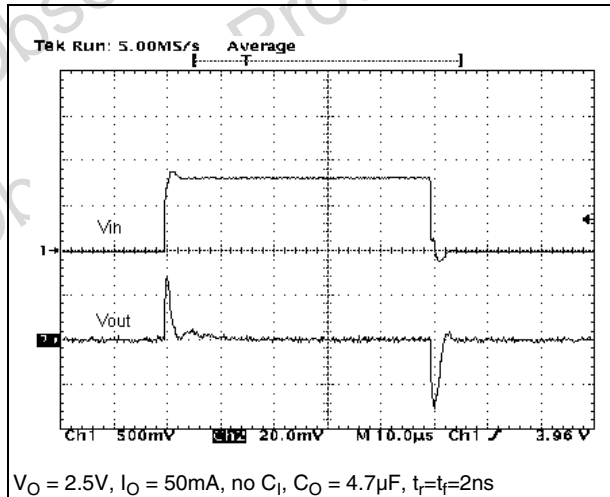

Figure 14. Line transient

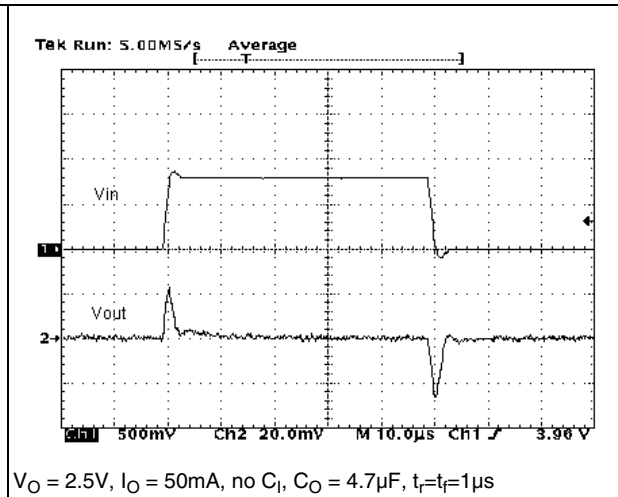
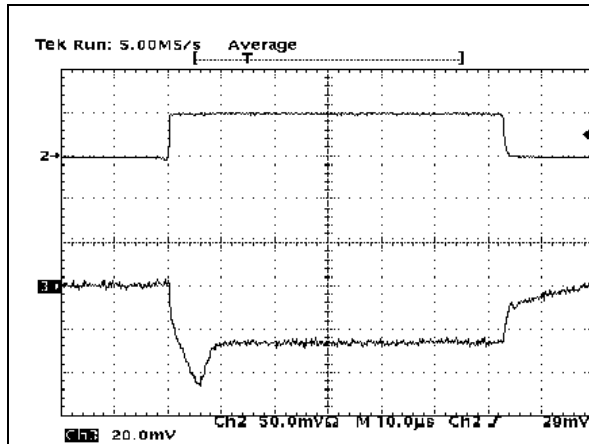
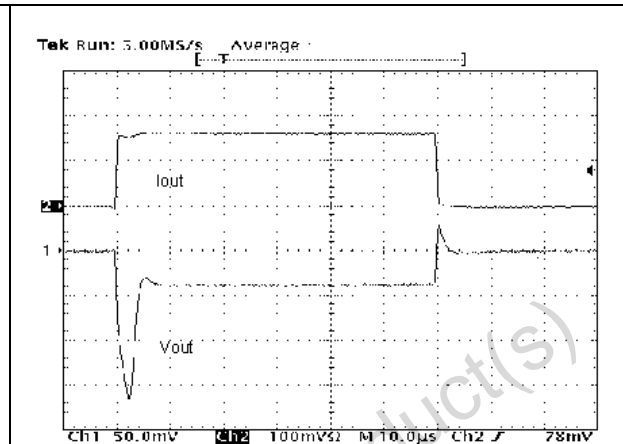

Figure 15. Load transient



$V_O = 2.5V$, $I_O = 0$ to $50mA$, no C_I , $C_O = 10\mu F$, $t_r = t_f = 2ns$

Figure 16. Load transient



$V_O = 2.5V$, $I_O = 0$ to $50mA$, no C_I , $C_O = 4.7\mu F$, $t_r = t_f = 2ns$

Obsolete Product(s) - Obsolete Product(s)
 Obsolete Product(s) - Obsolete Product(s)

6 Application notes

6.1 External capacitors

Like any low-dropout regulator, the LD2982 requires external capacitors for regulator stability. This capacitor must be selected to meet the requirements of minimum capacitance and equivalent series resistance. We suggest to solder input and output capacitors as close as possible to the relative pins.

6.2 Input capacitor

An input capacitor whose value is 1 μF is required with the LD2982 (amount of capacitance can be increased without limit). This capacitor must be located a distance of not more than 0.5" from the input pin of the device and returned to a clean analog ground. Any good quality ceramic, tantalum or film capacitors can be used for this capacitor.

6.3 Output capacitor

The LD2982 is designed specifically to work with ceramic output capacitors. It may also be possible to use tantalum capacitors, but these are not as attractive for reasons of size and cost. By the way, the output capacitor must meet both the requirement for minimum amount of capacitance and ESR (equivalent series resistance) value. Due to the different loop gain, the stability improves for higher output versions and so the suggested minimum output capacitor value, if low ESR ceramic type is used, is 1 μF for output voltages equal or major than 3.8 V, 2.2 μF for V_{O} going from 1.8 to 3.3 V, and 3.3 μF for the other versions. However, if an output capacitor lower than the suggested one is used, it's possible to make stable the regulator adding a resistor in series to the capacitor.

6.4 Important

The output capacitor must maintain its ESR in the stable region over the full operating temperature to assure stability. Also, capacitor tolerance and variation with temperature must be considered to assure the minimum amount of capacitance is provided at all times. This capacitor should be located not more than 0.5" from the output pin of the device and returned to a clean analog ground.

6.5 Inhibit input operation

The inhibit pin can be used to turn OFF the regulator when pulled low, so drastically reducing the current consumption down to less than 1 μA . When the inhibit feature is not used, this pin must be tied to V_{I} to keep the regulator output ON at all times. To assure proper operation, the signal source used to drive the inhibit pin must be able to swing above and below the specified thresholds listed in the electrical characteristics section under V_{IH} V_{IL} . Any slew rate can be used to drive the inhibit.

6.6 Reverse current

The power transistor used in the LD2982 has not an inherent diode connected between the regulator input and output. If the output is forced above the input, no current will flow from the output to the input across the series pass transistor. When a V_{REV} voltage is applied on the output, the reverse current measured flows to the GND across the two feedback resistors. This current typical value is $160 \mu\text{A}$. R_1 and R_2 resistors are implanted type; typical values are, respectively, $42.6 \text{ k}\Omega$ and $51.150 \text{ k}\Omega$.

Figure 17. Reverse current test circuit

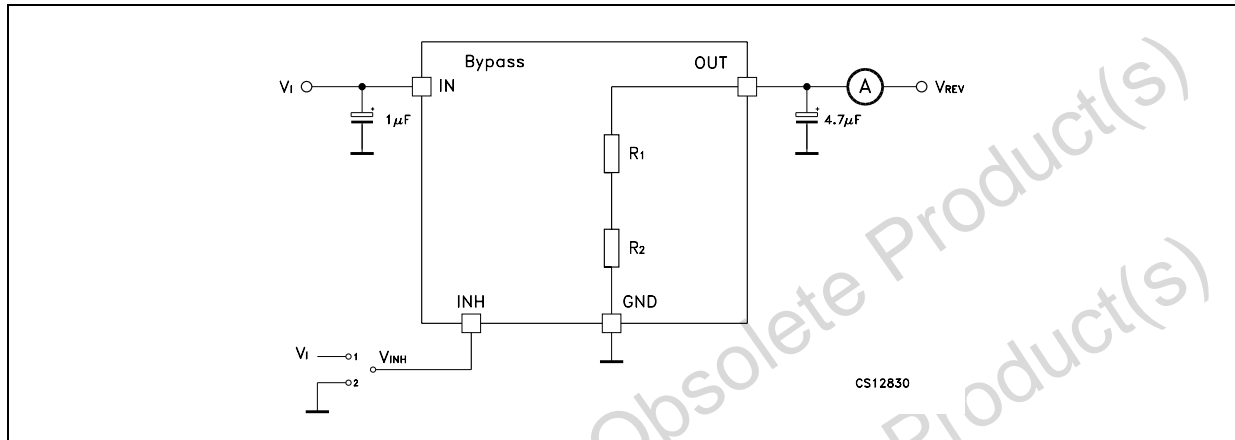

7 Package mechanical data

In order to meet environmental requirements, ST offers these devices in different grades of ECOPACK® packages, depending on their level of environmental compliance. ECOPACK® specifications, grade definitions and product status are available at: www.st.com. ECOPACK® is an ST trademark.

Obsolete Product(s) - Obsolete Product(s)
Obsolete Product(s) - Obsolete Product(s)

SOT23-5L mechanical data

Dim.	mm.			mils.		
	Min.	Typ.	Max.	Min.	Typ.	Max.
A	0.90		1.45	35.4		57.1
A1	0.00		0.10	0.0		3.9
A2	0.90		1.30	35.4		51.2
b	0.35		0.50	13.7		19.7
C	0.09		0.20	3.5		7.8
D	2.80		3.00	110.2		118.1
E	1.50		1.75	59.0		68.8
e		0.95			37.4	
H	2.60		3.00	102.3		118.1
L	0.10		0.60	3.9		23.6

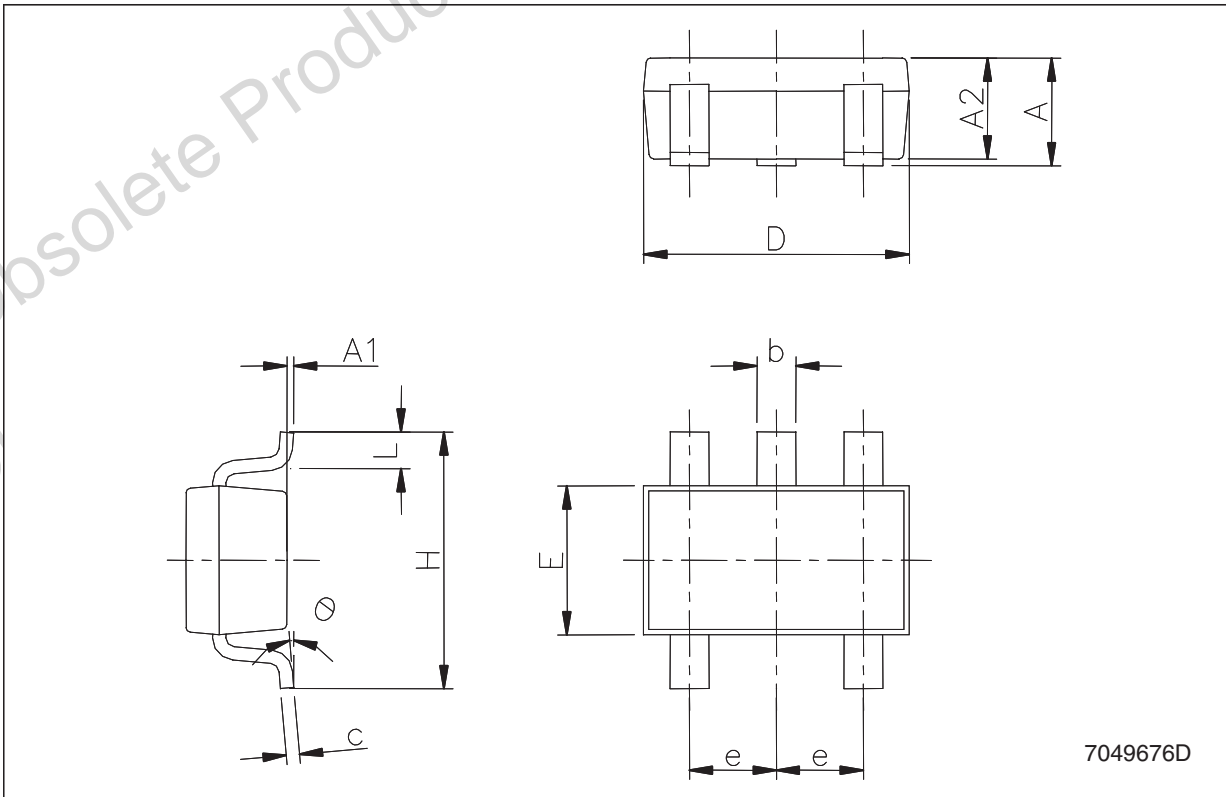

Tape & reel SOT23-xL mechanical data

Dim.	mm.			inch.		
	Min.	Typ.	Max.	Min.	Typ.	Max.
A			180			7.086
C	12.8	13.0	13.2	0.504	0.512	0.519
D	20.2			0.795		
N	60			2.362		
T			14.4			0.567
Ao	3.13	3.23	3.33	0.123	0.127	0.131
Bo	3.07	3.17	3.27	0.120	0.124	0.128
Ko	1.27	1.37	1.47	0.050	0.054	0.058
Po	3.9	4.0	4.1	0.153	0.157	0.161
P	3.9	4.0	4.1	0.153	0.157	0.161

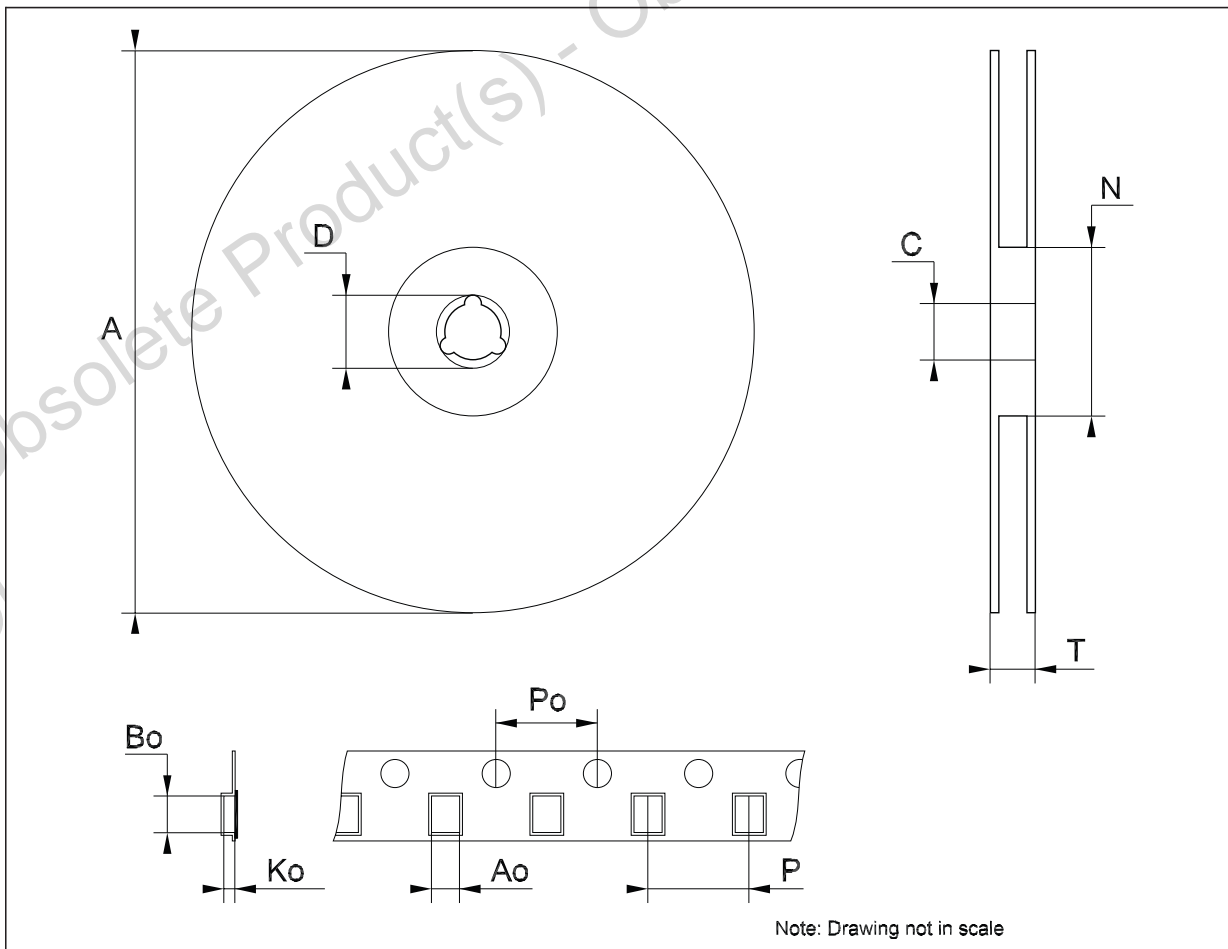

8 Revision history

Table 6. Document revision history

Date	Revision	Changes
25-Jul-2006	4	Order codes updated.
14-Feb-2008	5	Added: Table 1 on page 1 .
10-Jul-2008	6	Modified: Table 1 on page 1 and Table 5 on page 6 .
29-Jul-2009	7	Modified: Table 1 on page 1 .

Obsolete Product(s) - Obsolete Product(s)
Obsolete Product(s) - Obsolete Product(s)

Please Read Carefully:

Information in this document is provided solely in connection with ST products. STMicroelectronics NV and its subsidiaries ("ST") reserve the right to make changes, corrections, modifications or improvements, to this document, and the products and services described herein at any time, without notice.

All ST products are sold pursuant to ST's terms and conditions of sale.

Purchasers are solely responsible for the choice, selection and use of the ST products and services described herein, and ST assumes no liability whatsoever relating to the choice, selection or use of the ST products and services described herein.

No license, express or implied, by estoppel or otherwise, to any intellectual property rights is granted under this document. If any part of this document refers to any third party products or services it shall not be deemed a license grant by ST for the use of such third party products or services, or any intellectual property contained therein or considered as a warranty covering the use in any manner whatsoever of such third party products or services or any intellectual property contained therein.

UNLESS OTHERWISE SET FORTH IN ST'S TERMS AND CONDITIONS OF SALE ST DISCLAIMS ANY EXPRESS OR IMPLIED WARRANTY WITH RESPECT TO THE USE AND/OR SALE OF ST PRODUCTS INCLUDING WITHOUT LIMITATION IMPLIED WARRANTIES OF MERCHANTABILITY, FITNESS FOR A PARTICULAR PURPOSE (AND THEIR EQUIVALENTS UNDER THE LAWS OF ANY JURISDICTION), OR INFRINGEMENT OF ANY PATENT, COPYRIGHT OR OTHER INTELLECTUAL PROPERTY RIGHT.

UNLESS EXPRESSLY APPROVED IN WRITING BY AN AUTHORIZED ST REPRESENTATIVE, ST PRODUCTS ARE NOT RECOMMENDED, AUTHORIZED OR WARRANTED FOR USE IN MILITARY, AIR CRAFT, SPACE, LIFE SAVING, OR LIFE SUSTAINING APPLICATIONS, NOR IN PRODUCTS OR SYSTEMS WHERE FAILURE OR MALFUNCTION MAY RESULT IN PERSONAL INJURY, DEATH, OR SEVERE PROPERTY OR ENVIRONMENTAL DAMAGE. ST PRODUCTS WHICH ARE NOT SPECIFIED AS "AUTOMOTIVE GRADE" MAY ONLY BE USED IN AUTOMOTIVE APPLICATIONS AT USER'S OWN RISK.

Resale of ST products with provisions different from the statements and/or technical features set forth in this document shall immediately void any warranty granted by ST for the ST product or service described herein and shall not create or extend in any manner whatsoever, any liability of ST.

ST and the ST logo are trademarks or registered trademarks of ST in various countries.

Information in this document supersedes and replaces all information previously supplied.

The ST logo is a registered trademark of STMicroelectronics. All other names are the property of their respective owners.

© 2009 STMicroelectronics - All rights reserved

STMicroelectronics group of companies

Australia - Belgium - Brazil - Canada - China - Czech Republic - Finland - France - Germany - Hong Kong - India - Israel - Italy - Japan - Malaysia - Malta - Morocco - Philippines - Singapore - Spain - Sweden - Switzerland - United Kingdom - United States of America

www.st.com

Looking for pricing, stock, or lifecycle information?

Click below to explore more details on WIN SOURCE:

 [View LD2982AM47R on WIN SOURCE](#)

 [STMicroelectronics](#) Information

Optimize Your Supply Chain with WIN SOURCE Solutions

-  Global Sourcing Solution
-  Obsolete Management
-  Cost Control Management
-  Shortage Management
-  Alternative Solution
-  Excess Inventory Management