

# 2SB1216, 2SD1816

## Bipolar Transistor (-)100V, (-)4A, Low VCE(sat), (PNP)NPN Single



**ON Semiconductor®**

www.onsemi.com

### Features

- Low Collector to Emitter Saturation Voltage
- Small and Slim Package Facilitating Compactness of Sets
- High  $f_T$
- Good Linearity of  $h_{FE}$
- Fast Switching Time

### Typical Applications

- Suitable for Relay Drivers
- High Speed Inverters
- Converters
- Other General High Current Switching Applications

### SPECIFICATIONS ( ) : 2SB1216

#### ABSOLUTE MAXIMUM RATING at $T_a = 25^\circ\text{C}$ (Note 1)

Parameter	Symbol	Value	Unit
Collector to Base Voltage	$V_{CBO}$	(-) 120	V
Collector to Emitter Voltage	$V_{CEO}$	(-) 100	V
Emitter to Base Voltage	$V_{EBO}$	(-) 6	V
Collector Current	$I_C$	(-) 4	A
Collector Current (Pulse)	$I_{CP}$	(-) 8	A
Collector Dissipation	PC	1	W
		$T_c=25^\circ\text{C}$	20
Junction Temperature	$T_j$	150	$^\circ\text{C}$
Storage Temperature	$T_{stg}$	-55 to +150	$^\circ\text{C}$

Note 1 : Stresses exceeding those listed in the Maximum Ratings table may damage the device. If any of these limits are exceeded, device functionality should not be assumed, damage may occur and reliability may be affected.

### ELECTRICAL CONNECTION

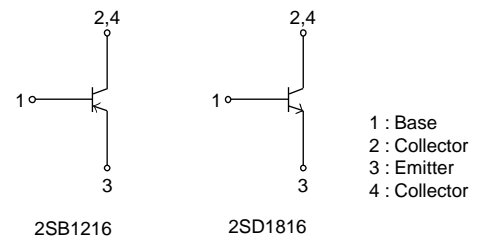

### MARKING

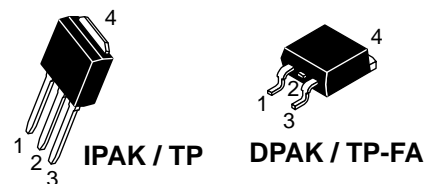
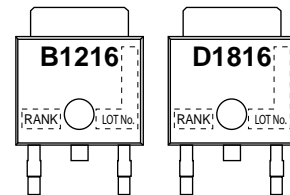

### ORDERING INFORMATION

See detailed ordering and shipping information on page 7 of this data sheet.

# 2SB1216, 2SD1816

## ELECTRICAL CHARACTERISTICS at Ta = 25°C (Note 2)

Parameter	Symbol	Conditions	Value			Unit
			min	typ	max	
Collector Cutoff Current	ICBO	V <sub>CB</sub> =(-)100V, I <sub>E</sub> =0A			(-) 1	μA
Emitter Cutoff Current	IEBO	V <sub>EB</sub> =(-)4V, I <sub>C</sub> =0A			(-) 1	μA
DC Current Gain	hFE1	V <sub>CE</sub> =(-)5V, I <sub>C</sub> =(-)0.5A	140*		400*	
	hFE2	V <sub>CE</sub> =(-)5V, I <sub>C</sub> =(-)3A	40			
Gain-Bandwidth Product	f <sub>T</sub>	V <sub>CE</sub> =(-)10V, I <sub>C</sub> =(-)0.5A		(130) 180		MHz
Output Capacitance	C <sub>ob</sub>	V <sub>CB</sub> =(-)10V, f=1MHz		(65) 40		pF
Collector to Emitter Saturation Voltage	V <sub>CE(sat)</sub>	I <sub>C</sub> =(-)2A, I <sub>B</sub> =(-)0.2A		(-200) 150	(-500) 400	mV
Base to Emitter Saturation Voltage	V <sub>BE(sat)</sub>	I <sub>C</sub> =(-)2A, I <sub>B</sub> =(-)0.2A		(-) 0.9	(-) 1.2	V
Collector to Base Breakdown Voltage	V <sub>(BR)CBO</sub>	I <sub>C</sub> =(-)10μA, I <sub>E</sub> =0A	(-)120			V
Collector to Emitter Breakdown Voltage	V <sub>(BR)CEO</sub>	I <sub>C</sub> =(-)1mA, R <sub>BE</sub> =∞	(-)100			V
Emitter to Base Breakdown Voltage	V <sub>(BR)EBO</sub>	I <sub>E</sub> =(-)10μA, I <sub>C</sub> =0A	(-) 6			V
Turn-On Time	t <sub>on</sub>	See specified Test Circuit		100		ns
Storage Time	t <sub>stg</sub>			(800) 900		ns
Fall Time	t <sub>f</sub>			50		ns

Note 2 : Product parametric performance is indicated in the Electrical Characteristics for the listed test conditions, unless otherwise noted. Product performance may not be indicated by the Electrical Characteristics if operated under different conditions.

\*: The 2SB1216/2SD1816 are classified by 0.5A h<sub>FE</sub> as follows:

Rank	S	T
h <sub>FE</sub>	140 to 280	200 to 400

**Fig.1 Switching Time Test Circuit**

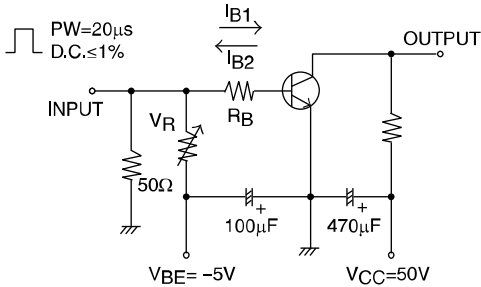

$$I_C = 10I_{B1} = -10I_{B2} = 2A$$

For PNP, the polarity is reversed.

# 2SB1216, 2SD1816

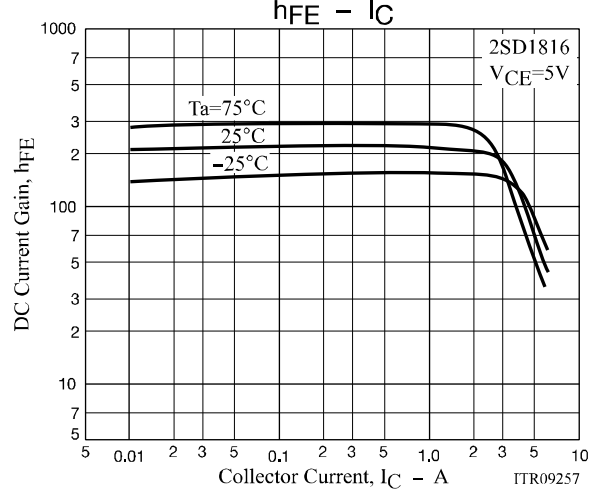
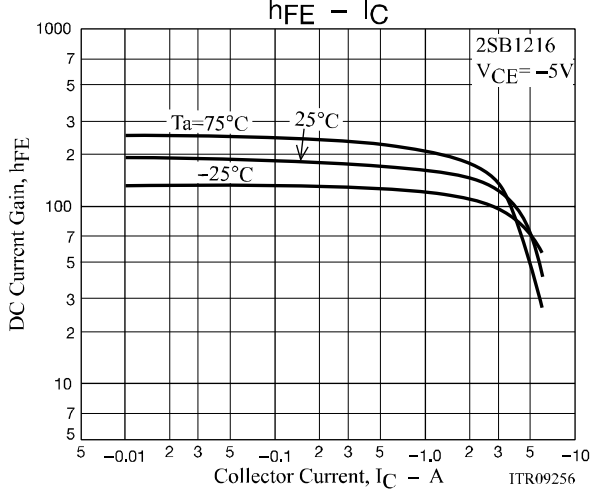
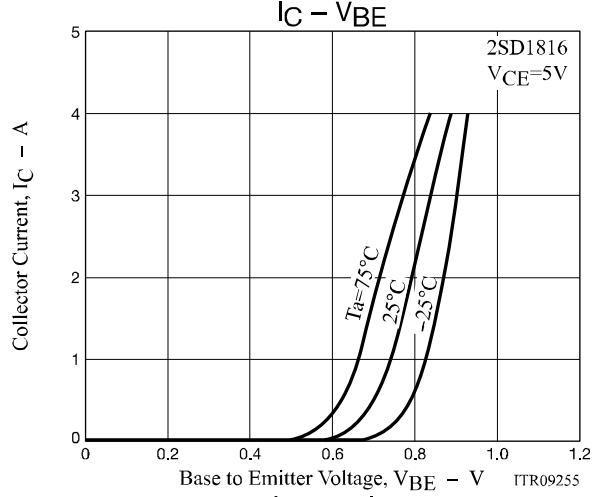
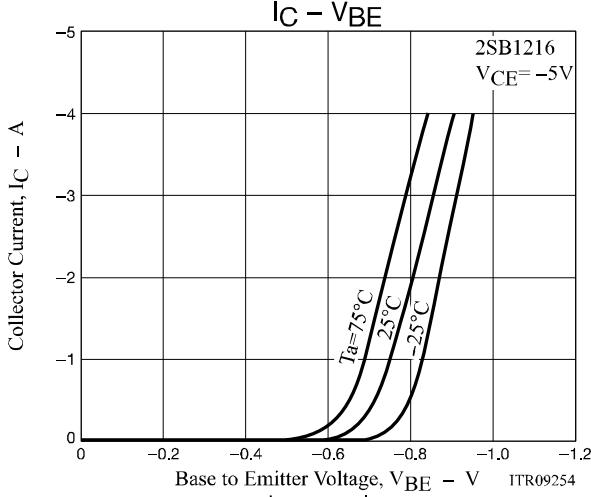
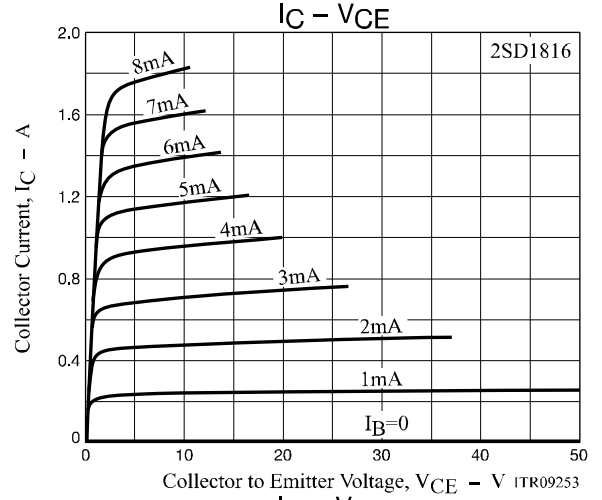
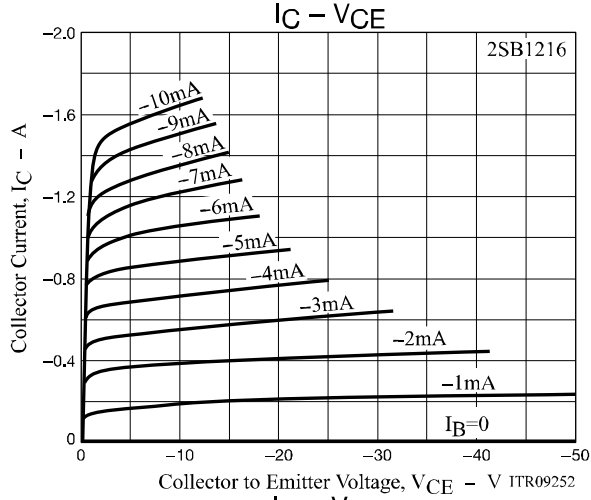
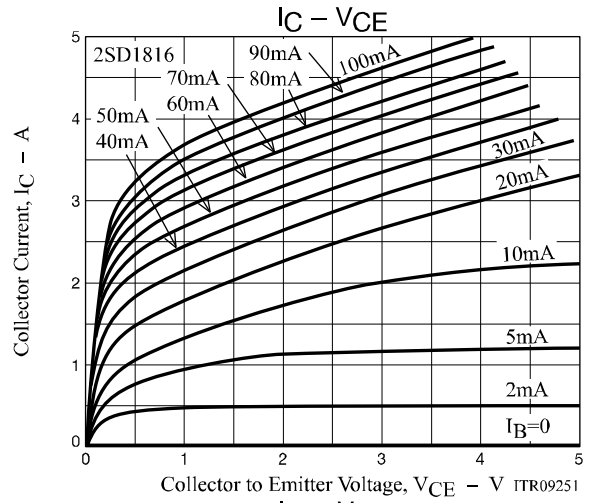
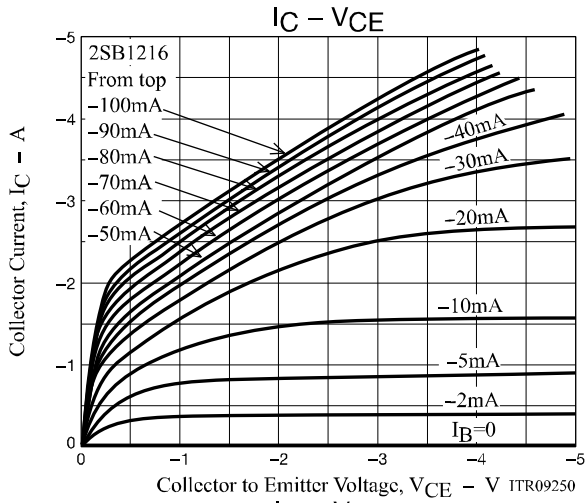

# 2SB1216, 2SD1816

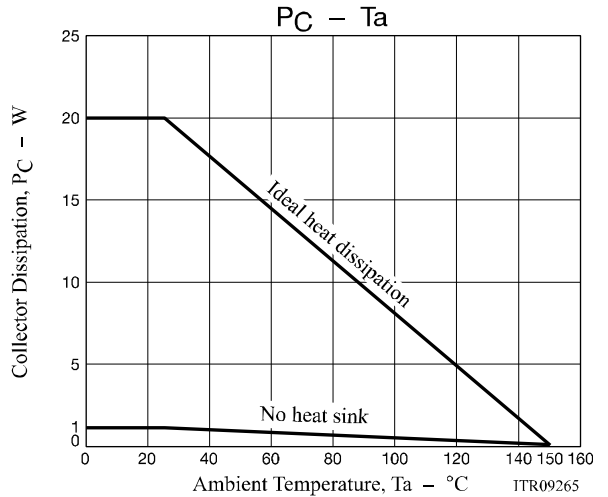
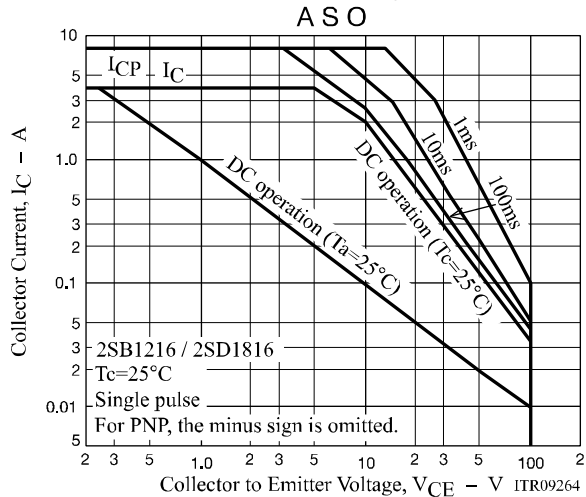
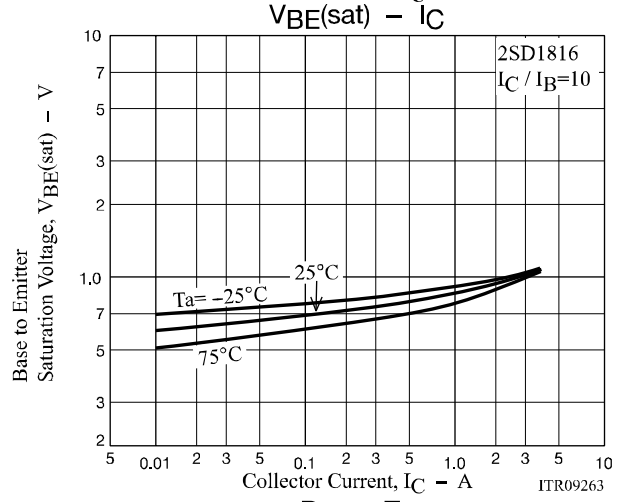
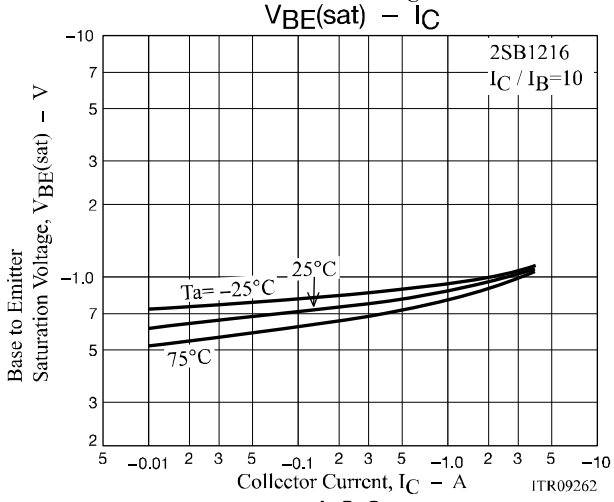
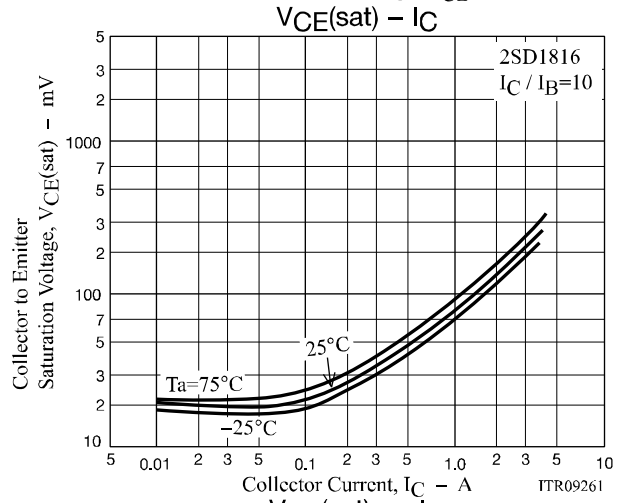
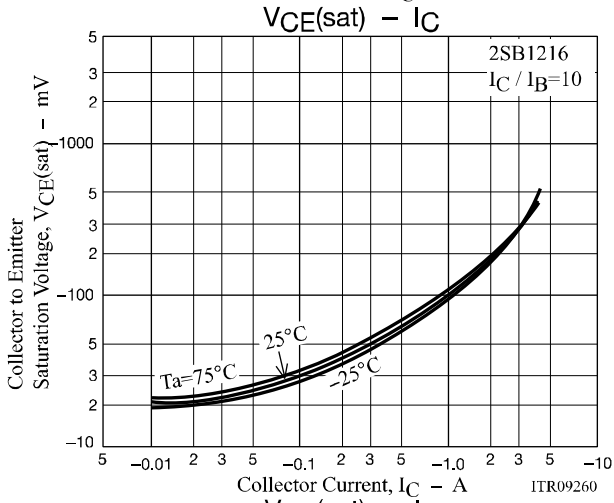
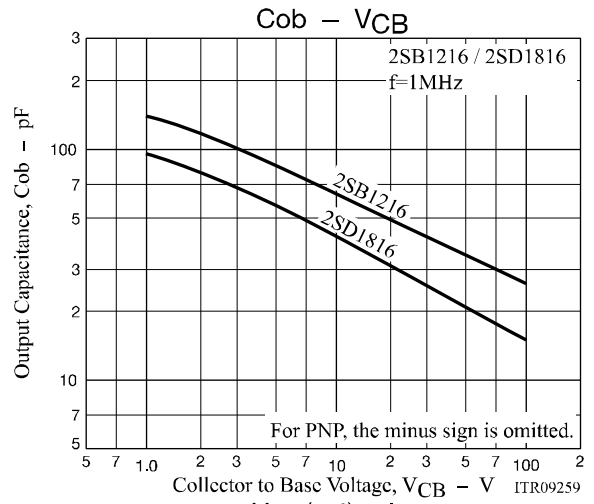
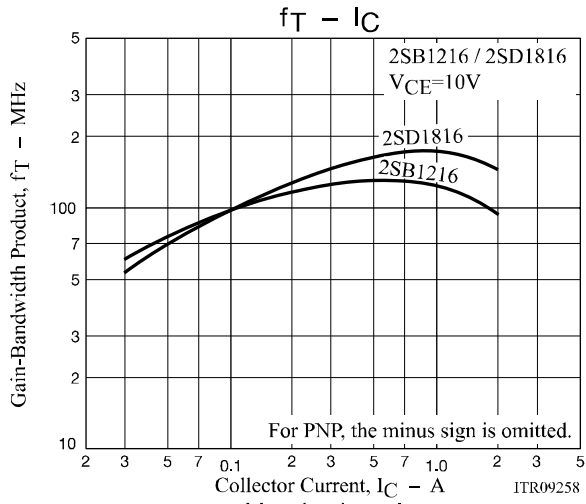

# 2SB1216, 2SD1816

## PACKAGE DIMENSIONS

unit : mm

IPAK / TP  
CASE 369AJ  
ISSUE O

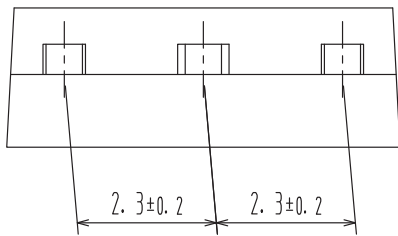
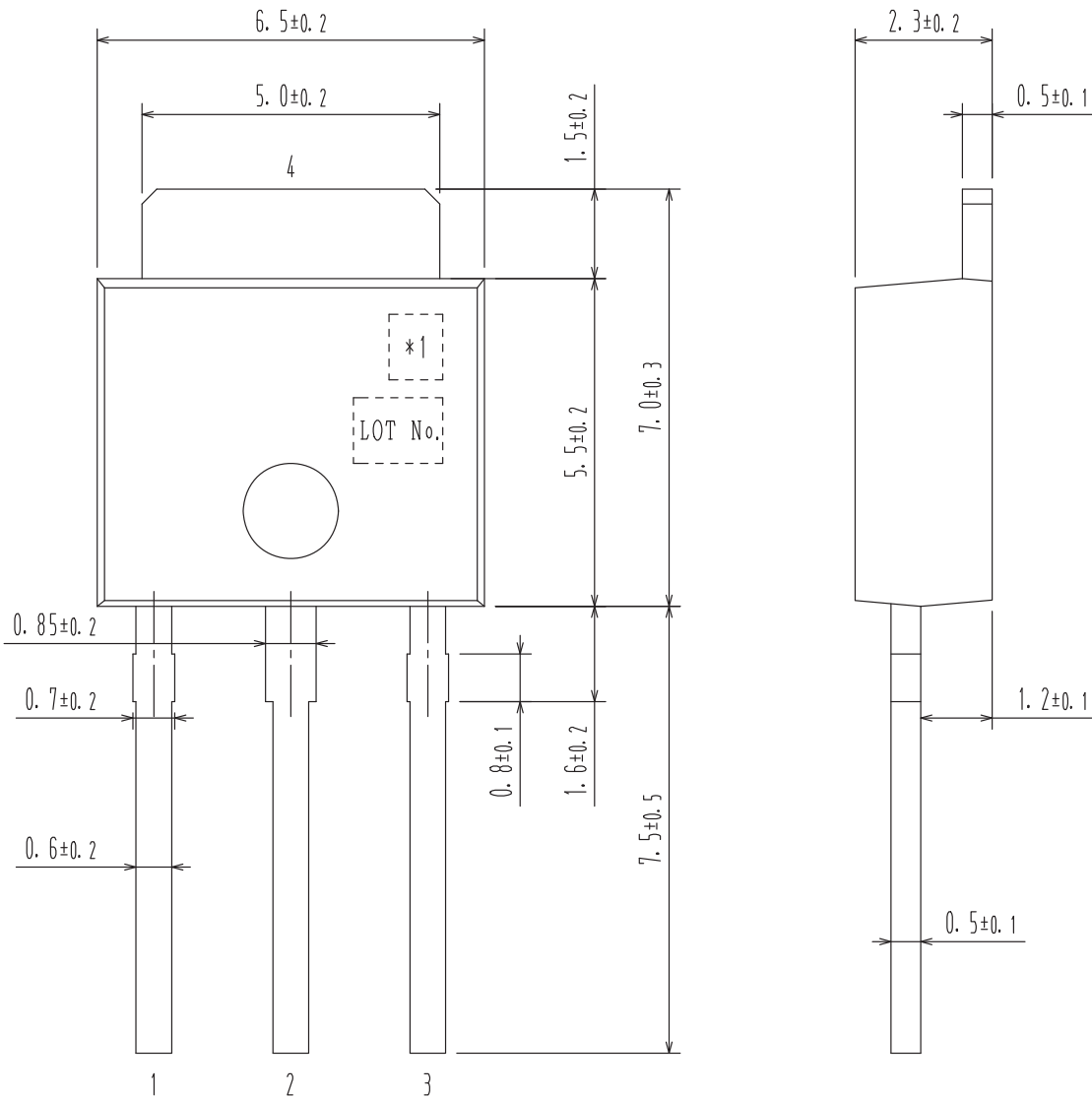

- 1 : Base
- 2 : Collector
- 3 : Emitter
- 4 : Collector

\*1: Lot indication

# 2SB1216, 2SD1816

## PACKAGE DIMENSIONS

unit : mm

### DPAK / TP-FA

CASE 369AH

ISSUE 0

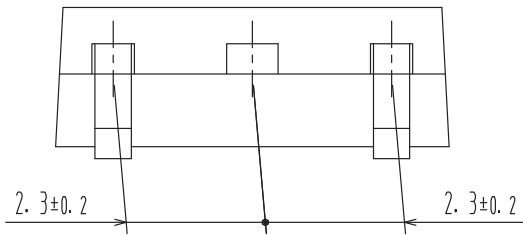
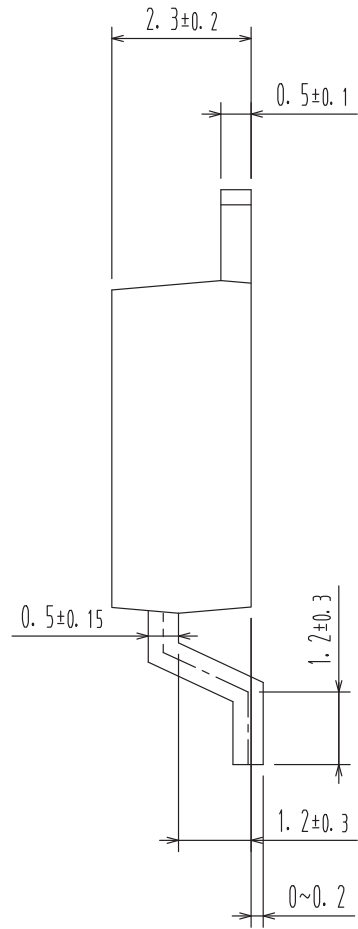
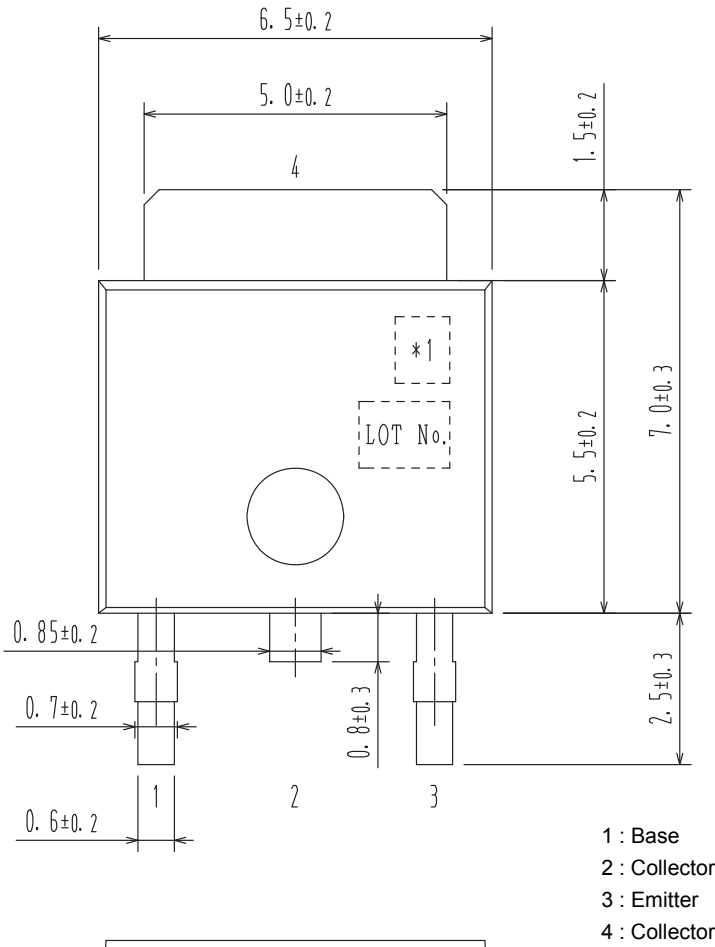

Pin 2 is idle pin with electrical designation only carried.

### Recommended Soldering Footprint

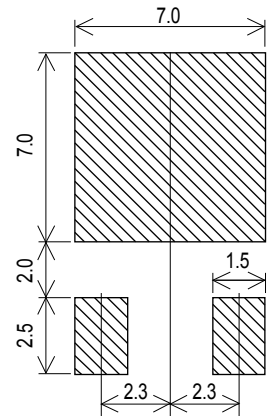

\*1: Lot indication

## 2SB1216, 2SD1816

### ORDERING INFORMATION



Device	Marking	Package	Shipping (Qty / Packing)
2SB1216S-E	B1216	IPAK / TP (Pb-Free)	500/ bag
2SB1216T-E	B1216		
2SD1816S-E	D1816		
2SD1816T-E	D1816		
2SB1216S-H	B1216	IPAK / TP (Pb-Free / Halogen Free)	
2SB1216T-H	B1216		
2SD1816S-H	D1816		
2SD1816T-H	D1816		
2SB1216S-TL-E	B1216	DPAK / TP-FA (Pb-Free)	700/ Tape & Reel
2SB1216T-TL-E	B1216		
2SD1816S-TL-E	D1816		
2SD1816T-TL-E	D1816		
2SB1216S-TL-H	B1216	DPAK / TP-FA (Pb-Free / Halogen Free)	
2SB1216T-TL-H	B1216		
2SD1816S-TL-H	D1816		
2SD1816T-TL-H	D1816		

† For information on tape and reel specifications, including part orientation and tape sizes, please refer to our Tape and Reel Packaging Specifications Brochure, BRD8011/D. [http://www.onsemi.com/pub\\_link/Collateral/BRD8011-D.PDF](http://www.onsemi.com/pub_link/Collateral/BRD8011-D.PDF)

ON Semiconductor and the ON logo are registered trademarks of Semiconductor Components Industries, LLC (SCILLC) or its subsidiaries in the United States and/or other countries. SCILLC owns the rights to a number of patents, trademarks, copyrights, trade secrets, and other intellectual property. A listing of SCILLC's product/patent coverage may be accessed at [www.onsemi.com/site/pdf/Patent-Marking.pdf](http://www.onsemi.com/site/pdf/Patent-Marking.pdf). SCILLC reserves the right to make changes without further notice to any products herein. SCILLC makes no warranty, representation or guarantee regarding the suitability of its products for any particular purpose, nor does SCILLC assume any liability arising out of the application or use of any product or circuit, and specifically disclaims any and all liability, including without limitation special, consequential or incidental damages. "Typical" parameters which may be provided in SCILLC data sheets and/or specifications can and do vary in different applications and actual performance may vary over time. All operating parameters, including "Typicals" must be validated for each customer application by customer's technical experts. SCILLC does not convey any license under its patent rights nor the rights of others. SCILLC products are not designed, intended, or authorized for use as components in systems intended for surgical implant into the body, or other applications intended to support or sustain life, or for any other application in which the failure of the SCILLC product could create a situation where personal injury or death may occur. Should Buyer purchase or use SCILLC products for any such unintended or unauthorized application, Buyer shall indemnify and hold SCILLC and its officers, employees, subsidiaries, affiliates, and distributors harmless against all claims, costs, damages, and expenses, and reasonable attorney fees arising out of, directly or indirectly, any claim of personal injury or death associated with such unintended or unauthorized use, even if such claim alleges that SCILLC was negligent regarding the design or manufacture of the part. SCILLC is an Equal Opportunity/Affirmative Action Employer. This literature is subject to all applicable copyright laws and is not for resale in any manner.

## Looking for pricing, stock, or lifecycle information?

Click below to explore more details on WIN SOURCE:

-  [View 2SD1816S-TL-H on WIN SOURCE](#)
-  [ON Semiconductor](#) Information

## Optimize Your Supply Chain with WIN SOURCE Solutions

-  Global Sourcing Solution
-  Obsolete Management
-  Cost Control Management
-  Shortage Management
-  Alternative Solution
-  Excess Inventory Management