



**THE DATASHEET OF
TSM9938TEUK+T**



A 1 μ A, SOT23 Precision Current-Sense Amplifier

FEATURES

- ◆ Alternate-source for MAX9938
- ◆ Ultra-Low Supply Current: 1 μ A
- ◆ Wide Input Common Mode Range: +1.6V to +28V
- ◆ Low Input Offset Voltage: 500 μ V (max)
- ◆ Low Gain Error: <0.5% (max)
- ◆ Voltage Output
- ◆ Four Gain Options Available:
 - TSM9938T: Gain = 25V/V
 - TSM9938F: Gain = 50V/V
 - TSM9938H: Gain = 100V/V
 - TSM9938W: Gain = 200V/V
- ◆ 5-Pin SOT23 Packaging

APPLICATIONS

Notebook Computers
 Power Management Systems
 Portable/Battery-Powered Systems
 PDAs
 Smart Phones

DESCRIPTION

The voltage-output TSM9938 current-sense amplifiers are electrically and form-factor identical to the MAX9938 current-sense amplifiers. Consuming a very low 1 μ A supply current, the TSM9938 high-side current-sense amplifiers exhibit a 500- μ V (max) V_{OS} and a 0.5% (max) gain error, both specifications optimized for any precision current measurement. For all high-side current-sensing applications, the TSM9938 features a wide input common-mode voltage range from 1.6V to 28V.

The SOT23 package makes the TSM9938 an ideal choice for pcb-area-critical, low-current, high-accuracy current-sense applications in all battery-powered portable instruments.

All TSM9938s are specified for operation over the -40 $^{\circ}$ C to +85 $^{\circ}$ C extended temperature range.

TYPICAL APPLICATION CIRCUIT

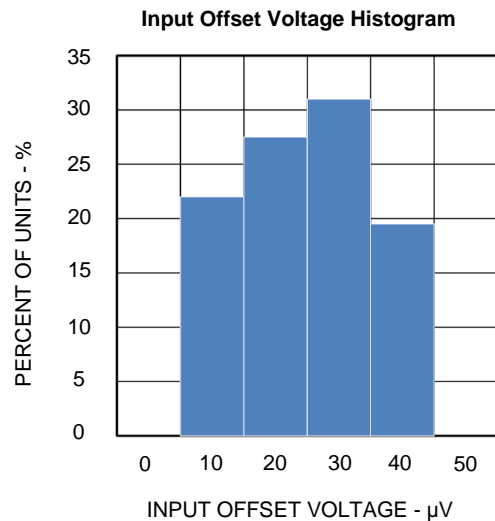
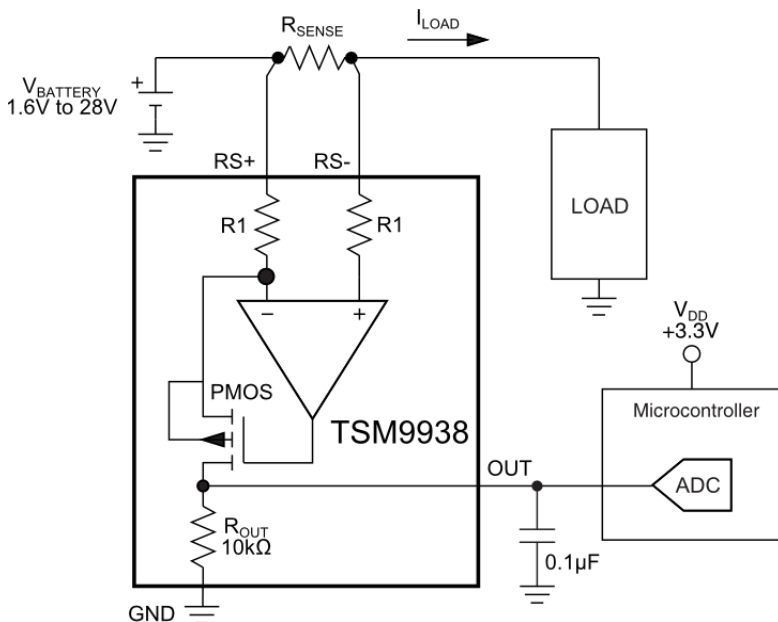

PART	GAIN OPTION
TSM9938T	25 V/V
TSM9938F	50 V/V
TSM9938H	100 V/V
TSM9938W	200 V/V

The Touchstone Semiconductor logo is a registered trademark of Touchstone Semiconductor, Incorporated.

ABSOLUTE MAXIMUM RATINGS

RS+, RS- to GND-0.3V to +30V
 OUT to GND.....-0.3V to +6V
 RS+ to RS-..... ±30V
 Short-Circuit Duration: OUT to GND Continuous
 Continuous Input Current (Any Pin) ±20mA
 Continuous Power Dissipation (T_A = +70°C)
 5-Pin SOT23 (Derate at 3.9mW/°C above +70°C).. 312mW

Operating Temperature Range -40°C to +85°C
 Junction Temperature +150°C
 Storage Temperature Range -65°C to +150°C
 Lead Temperature (Soldering, 10s) +300°C
 Soldering Temperature (Reflow) +260°C

Electrical and thermal stresses beyond those listed under “Absolute Maximum Ratings” may cause permanent damage to the device. These are stress ratings only and functional operation of the device at these or any other condition beyond those indicated in the operational sections of the specifications is not implied. Exposure to any absolute maximum rating conditions for extended periods may affect device reliability and lifetime.

PACKAGE/ORDERING INFORMATION

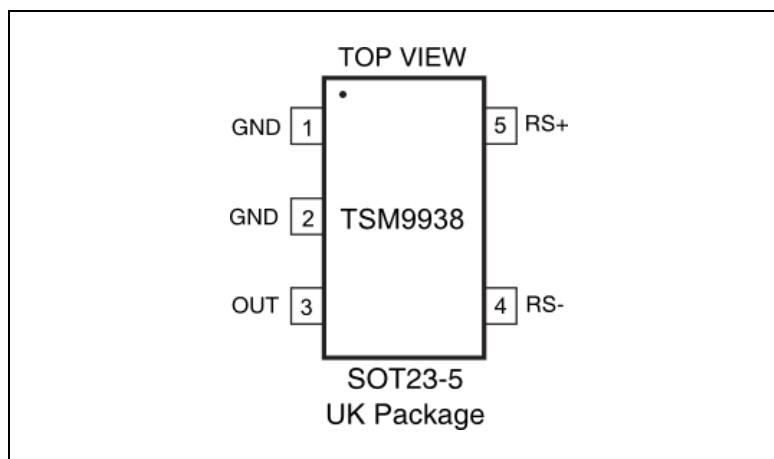

ORDER NUMBER	PART MARKING	CARRIER	QUANTITY
TSM9938TEUK+TP	TADC	Tape & Reel	-----
TSM9938TEUK+T		Tape & Reel	3000
TSM9938FEUK+TP	TADA	Tape & Reel	-----
TSM9938FEUK+T		Tape & Reel	3000
TSM9938HEUK+TP	TADF	Tape & Reel	-----
TSM9938HEUK+T		Tape & Reel	3000
TSM9938WEUK+TP	TADH	Tape & Reel	-----
TSM9938WEUK+T		Tape & Reel	3000

Lead-free Program: Touchstone Semiconductor supplies only lead-free packaging.

Consult Touchstone Semiconductor for products specified with wider operating temperature ranges.

ELECTRICAL CHARACTERISTICS

$V_{RS+} = V_{RS-} = 3.6V$; $V_{SENSE} = (V_{RS+} - V_{RS-}) = 0V$; $T_A = -40^{\circ}C$ to $+85^{\circ}C$, unless otherwise noted. Typical values are at $T_A = +25^{\circ}C$. See Note 1

PARAMETER	SYMBOL	CONDITIONS	MIN	TYP	MAX	UNITS	
Supply Current (Note 2)	I_{CC}	$V_{RS+} = 5V, T_A = +25^{\circ}C$		0.5	0.85	μA	
		$V_{RS+} = 5V, -40^{\circ}C < T_A < +85^{\circ}C$			1.1		
		$V_{RS+} = 28V, T_A = +25^{\circ}C$		1.1	1.8		
		$V_{RS+} = 28V, -40^{\circ}C < T_A < +85^{\circ}C$			2.5		
Common-Mode Input Range	V_{CM}	Guaranteed by CMRR, $-40^{\circ}C < T_A < +85^{\circ}C$	1.6		28	V	
Common-Mode Rejection Ratio	CMRR	$1.6V < V_{RS+} < 28V, -40^{\circ}C < T_A < +85^{\circ}C$	94	130		dB	
Input Offset Voltage (Note 3)	V_{OS}	$T_A = +25^{\circ}C$		± 100	± 500	μV	
		$-40^{\circ}C < T_A < +85^{\circ}C$			± 600		
Gain	G	TSM9938T		25		V/V	
		TSM9938F		50			
		TSM9938H		100			
		TSM9938W		200			
Gain Error (Note 4)	GE	TSM9938T/TSM9938F/TSM9938H	$T_A = +25^{\circ}C$	± 0.1	± 0.5	%	
			$-40^{\circ}C < T_A < +85^{\circ}C$		± 0.6		
		TSM9938W	$T_A = +25^{\circ}C$	± 0.1	± 0.7		
			$-40^{\circ}C < T_A < +85^{\circ}C$		± 0.8		
Output Resistance	R_{OUT}	(Note 5)	TSM9938T/F/H	7.0	10	13.2	k Ω
			TSM9938W	14.0	20	26.4	
OUT Low Voltage	V_{OL}	Gain = 25		1.5	15	mV	
		Gain = 50		3	30		
		Gain = 100		6	60		
		Gain = 200		12	120		
OUT High Voltage	V_{OH}	$V_{OH} = V_{RS-} - V_{OUT}$ (Note 6)		0.1	0.2	V	

Note 1: All devices are 100% production tested at $T_A = +25^{\circ}C$. All temperature limits are guaranteed by product characterization.

Note 2: Extrapolated to $V_{OUT} = 0$. I_{CC} is the total current into the RS+ and the RS- pins.

Note 3: Input offset voltage V_{OS} is extrapolated from V_{OUT} with V_{SENSE} set to 1mV.

Note 4: Gain error is calculated by applying two values for V_{SENSE} and then calculating the error of the actual slope vs. the ideal transfer characteristic:

For GAIN = 25, the applied V_{SENSE} is 20mV and 120mV.

For GAIN = 50, the applied V_{SENSE} is 10mV and 60mV.

For GAIN = 100, the applied V_{SENSE} is 5mV and 30mV.

For GAIN = 200, the applied V_{SENSE} is 2.5mV and 15mV.

Note 5: The device is stable for any capacitive load at V_{OUT} .

Note 6: V_{OH} is the voltage from V_{RS-} to V_{OUT} with $V_{SENSE} = 3.6V/GAIN$.

TYPICAL PERFORMANCE CHARACTERISTICS

$V_{RS+} = V_{RS-} = 3.6V$; $T_A = +25^\circ C$, unless otherwise noted.

Input Offset Voltage Histogram

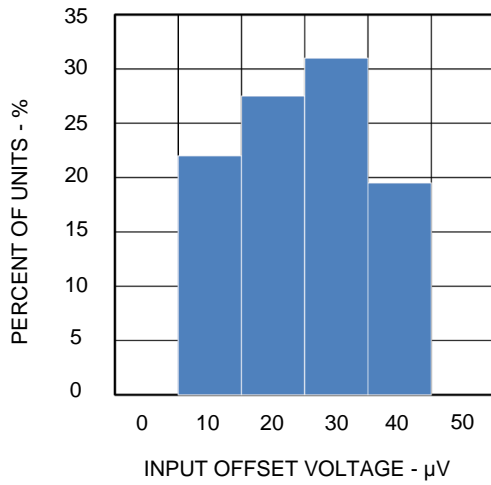

Gain Error Histogram

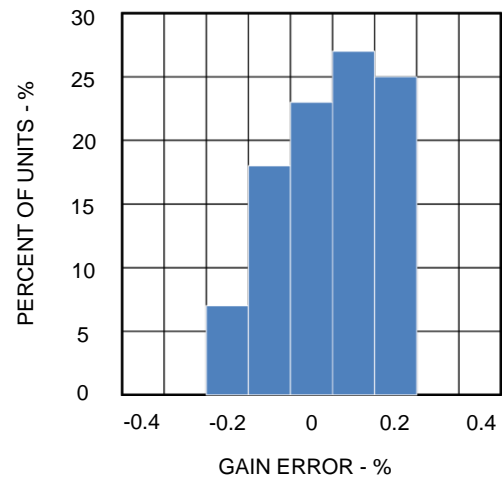

Supply Current vs Temperature

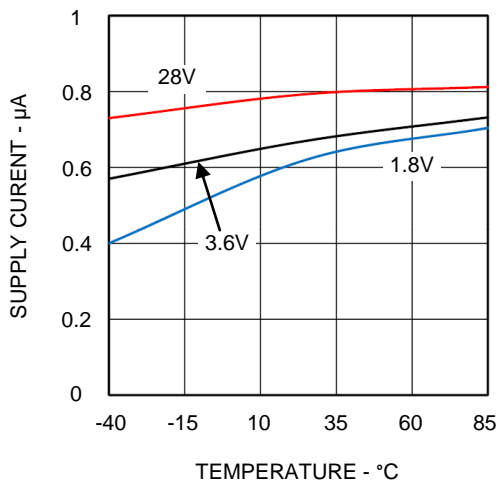

Input Offset Voltage vs Common-Mode Voltage

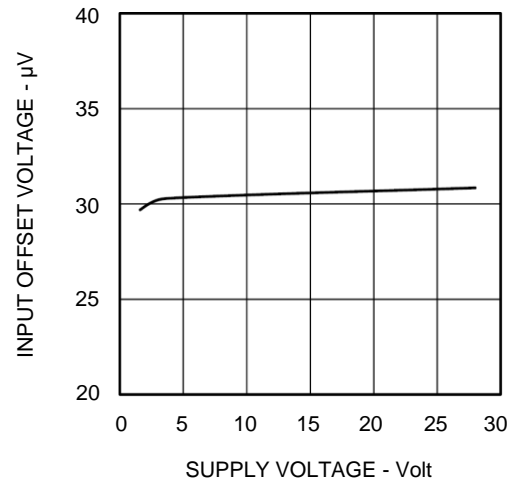

Input Offset Voltage vs Temperature

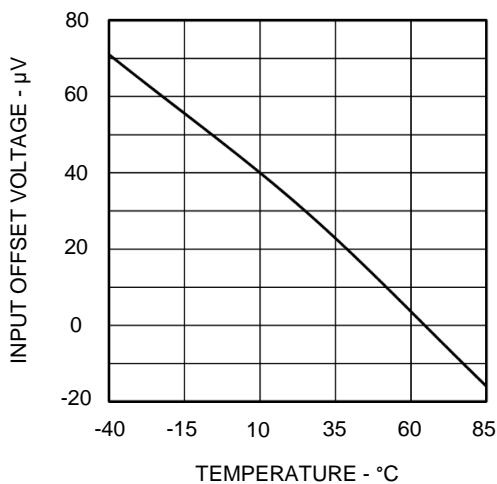

Supply Current vs Common-Mode Voltage

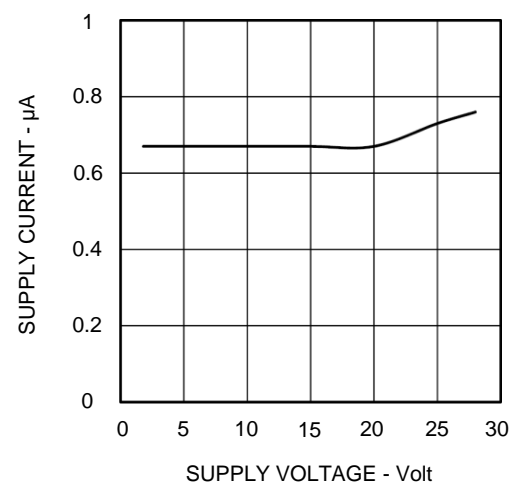

TYPICAL PERFORMANCE CHARACTERISTICS

$V_{RS+} = V_{RS-} = 3.6V$; $T_A = +25^\circ C$, unless otherwise noted.

Gain Error vs Common-Mode Voltage

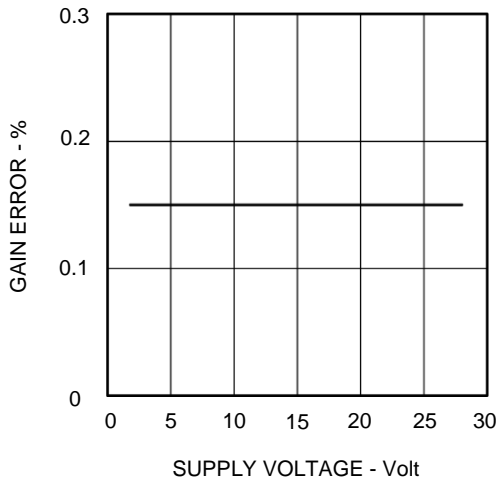

Gain Error vs. Temperature

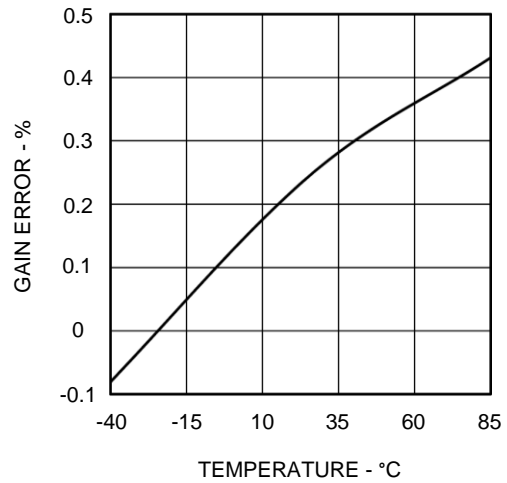

V_{OUT} vs V_{SENSE} @ Supply = 3.6V

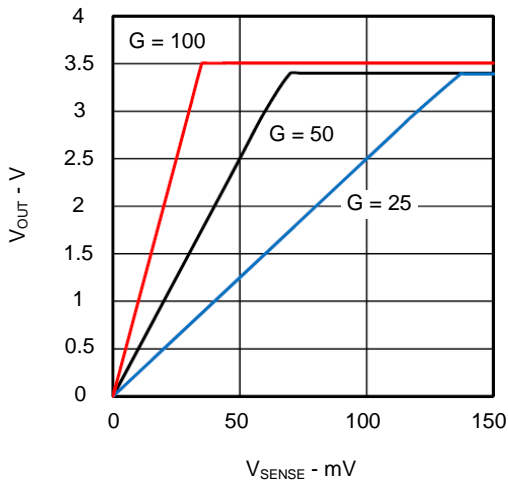

V_{OUT} vs V_{SENSE} @ Supply = 1.6V

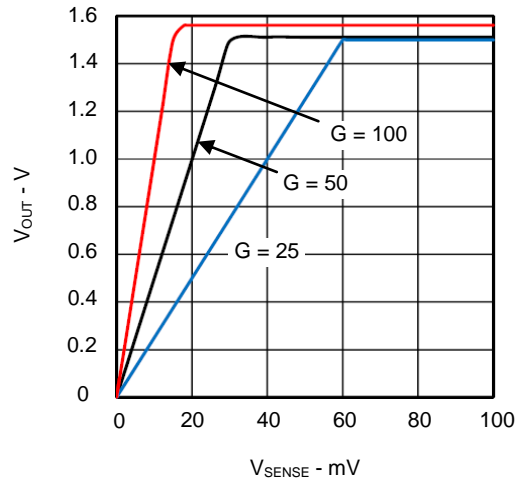

Small-Signal Gain vs Frequency

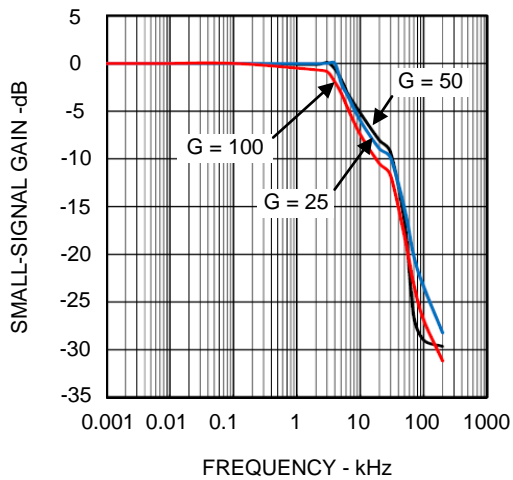

Common-Mode Rejection vs Frequency

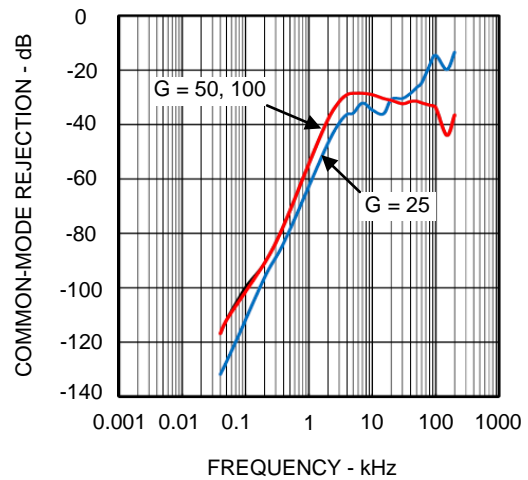

TYPICAL PERFORMANCE CHARACTERISTICS

$V_{RS+} = V_{RS-} = 3.6V$; $T_A = +25^\circ C$, unless otherwise noted.

Small-Signal Pulse Response, Gain = 50

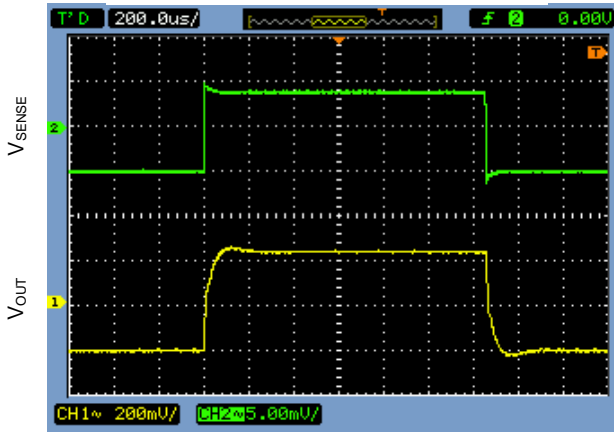

200 μs /DIV

Large-Signal Pulse Response, Gain = 50

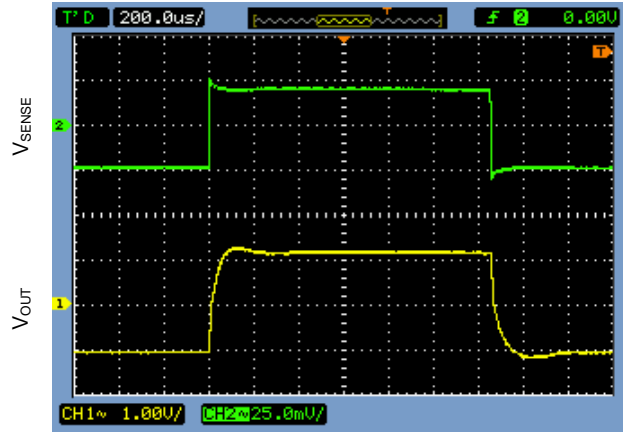

200 μs /DIV

Small-Signal Pulse Response, Gain = 25

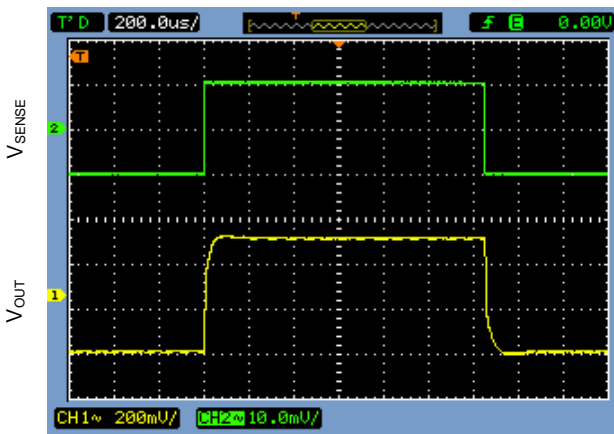

200 μs /DIV

Large-Signal Pulse Response, Gain = 25

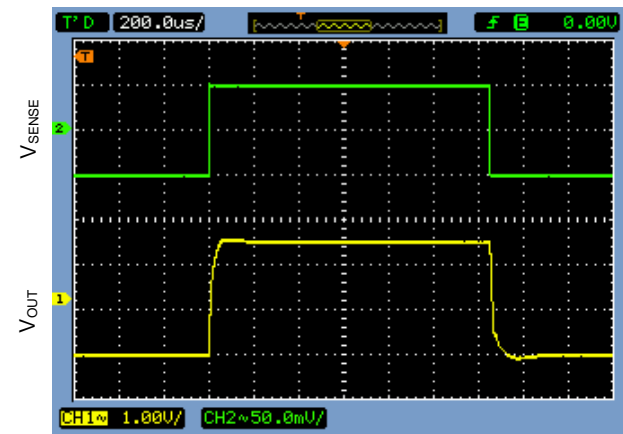

200 μs /DIV

Small-Signal Pulse Response, Gain = 100

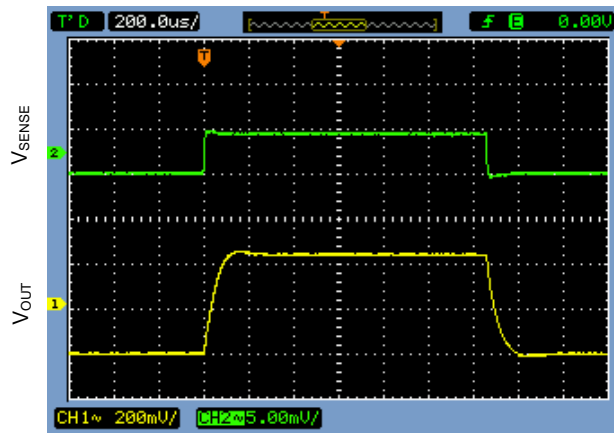

200 μs /DIV

Large-Signal Pulse Response, Gain = 100

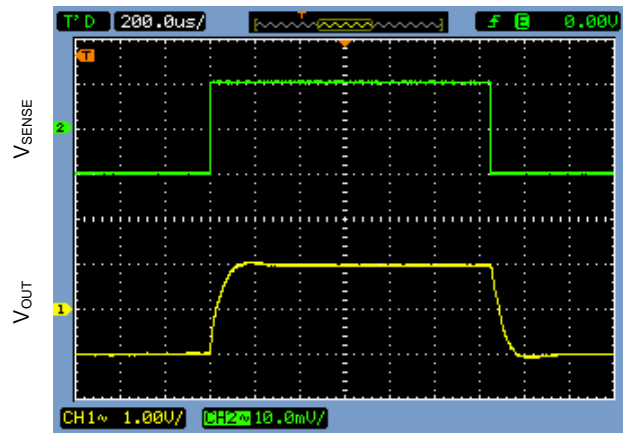

200 μs /DIV

PIN FUNCTIONS

PIN SOT23	LABEL	FUNCTION
5	RS+	External Sense Resistor Power-Side Connection
4	RS-	External Sense Resistor Load-Side Connection
1, 2	GND	Ground. Connect these pins to analog ground.
3	OUT	Output Voltage. V_{OUT} is proportional to $V_{SENSE} = V_{RS+} - V_{RS-}$.

BLOCK DIAGRAMS

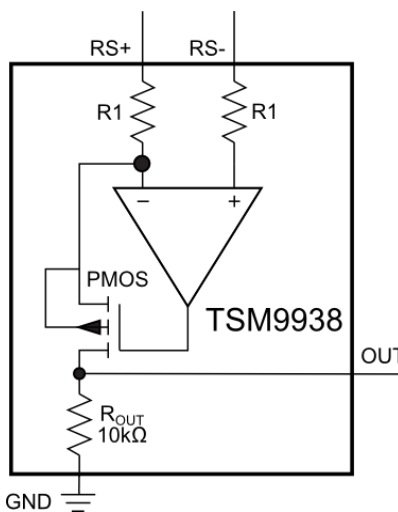

DESCRIPTION OF OPERATION

The internal configuration of the TSM9938 – a unidirectional high-side, current-sense amplifier - is based on a commonly-used operational amplifier (op amp) circuit for measuring load currents (in one direction) in the presence of high-common-mode voltages. In the general case, a current-sense amplifier monitors the voltage caused by a load current through an external sense resistor and generates an output voltage as a function of that load current. Referring to the typical application circuit on Page 1, the inputs of the op-amp-based circuit are connected across an external RSENSE resistor that is used to measure load current. At the non-inverting input of the TSM9938 (the RS+ terminal), the applied voltage is $I_{LOAD} \times RSENSE$. Since the RS- terminal is the non-inverting input of the internal op amp, op-amp feedback action forces the inverting input of the internal op amp to the same potential ($I_{LOAD} \times RSENSE$). Therefore, the voltage drop across

RSENSE (V_{SENSE}) and the voltage drop across R1 (at the RS+ terminal) are equal. To minimize any additional error because of op-amp input bias current mismatch, both R1s are the same value.

Since the internal p-channel FET's source is connected to the inverting input of the internal op amp and since the voltage drop across R1 is the same as the external V_{SENSE} , op amp feedback action drives the gate of the FET such that the FET's drain-source current is equal to:

$$I_{DS} = \frac{V_{SENSE}}{R1}$$

or

$$I_{DS} = \frac{I_{LOAD} \times R_{SENSE}}{R1}$$

Since the FET's drain terminal is connected to ROUT, the output voltage of the TSM9938 at the OUT terminal is, therefore;

$$V_{OUT} = I_{LOAD} \times R_{SENSE} \times \frac{R_{OUT}}{R1}$$

The current-sense amplifier's gain accuracy is therefore the ratio match of ROUT to R1. For each of the four gain options available, Table 1 lists the values for ROUT and R1. The TSM9938's output

stage is protected against input overdrive by use of an output current-limiting circuit of 3mA (typical) and a 7V internal clamp protection circuit.

Table 1: Internal Gain Setting Resistors (Typical Values)

GAIN (V/V)	R1 (Ω)	ROUT (Ω)	Part Number
25	400	10k	TSM9938T
50	200	10k	TSM9938F
100	100	10k	TSM9938H
200	100	20k	TSM9938W

APPLICATIONS INFORMATION

Choosing the Sense Resistor

Selecting the optimal value for the external RSENSE is based on the following criteria and for each commentary follows:

- 1) RSENSE Voltage Loss
- 2) VOUT Swing vs. Applied Input Voltage at VRS+ and Desired VSENSE
- 3) Total ILOAD Accuracy
- 4) Circuit Efficiency and Power Dissipation
- 5) RSENSE Kelvin Connections

1) RSENSE Voltage Loss

For lowest IR voltage loss in RSENSE, the smallest usable value for RSENSE should be selected.

2) VOUT Swing vs. Applied Input Voltage at VRS+ and Desired VSENSE

As there is no separate power supply pin for the TSM9938, the circuit draws its power from the applied voltage at both its RS+ and RS- terminals. Therefore, the signal voltage at the OUT terminal is bounded by the minimum supply voltage applied to the TSM9938.

Therefore,

$$V_{OUT(max)} = V_{RS+(min)} - V_{SENSE(max)} - V_{OH(max)}$$

and

$$R_{SENSE} = \frac{V_{OUT(max)}}{GAIN \times I_{LOAD(max)}}$$

where the full-scale VSENSE should be less than VOUT(MAX)/GAIN at the application's minimum RS+ terminal voltage. For best performance with a 3.6V power supply, RSENSE should be chosen to generate a VSENSE of: a) 120mV (for the 25V/V GAIN option), b) 60mV (for the 50V/V GAIN option), c) 30mV (for the 100V/V GAIN option), or d) 15mV (for the 200V/V GAIN option) at the full-scale ILOAD(MAX) current in each application. For the case where the minimum power supply voltage is higher than 3.6V, each of the four full-scale VSENSES above can be increased.

3) Total ILOAD Accuracy

In the TSM9938's linear region where VOUT < VOUT(max), there are two specifications related to the circuit's accuracy: a) the TSM9938's input offset voltage (VOS(max) = 500µV) and b) its gain error (GE(max) = 0.5%). An expression for the TSM9938's total output voltage (+ error) is given by:

$$V_{OUT} = [GAIN \times (1 \pm GE) \times V_{SENSE}] \pm (GAIN \times V_{OS})$$

A large value for RSENSE permits the use of smaller load currents to be measured more accurately because the effects of offset voltages are less significant when compared to larger VSENSE voltages. Due care though should be exercised as

previously mentioned with large values of RSENSE.

4) Circuit Efficiency and Power Dissipation

IR losses in RSENSE can be large especially at high load currents. It is important to select the smallest, usable RSENSE value to minimize power dissipation and to keep the physical size of RSENSE small. If the external RSENSE is allowed to dissipate significant power, then its inherent temperature coefficient may alter its design center value, thereby reducing load current measurement accuracy. Precisely because the TSM9938's input stage was designed to exhibit a very low input offset voltage, small RSENSE values can be used to reduce power dissipation and minimize local hot spots on the pcb.

5) RSENSE Kelvin Connections

For optimal V_{SENSE} accuracy in the presence of large load currents, parasitic pcb track resistance should be minimized. Kelvin-sense pcb connections

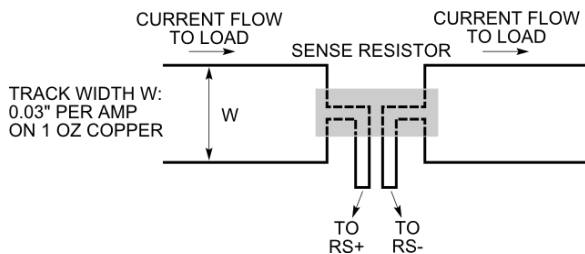

Figure 1: Making PCB Connections to the Sense Resistor (drawing is not to scale).

between RSENSE and the TSM9938's RS+ and RS- terminals are strongly recommended. The drawing in Figure 1 illustrates the connections between the current-sense amplifier and the current-sense resistor. The pcb layout should be balanced and symmetrical to minimize wiring-induced errors. In addition, the pcb layout for RSENSE should include good thermal management techniques for optimal RSENSE power dissipation.

Optional Output Filter Capacitor

If the TSM9938 is part of a signal acquisition system where its OUT terminal is connected to the input of an ADC with an internal, switched-capacitor track-and-hold circuit, the internal track-and-hold's sampling capacitor can cause voltage droop at V_{OUT} . A 22nF to 100nF good-quality ceramic capacitor from the OUT terminal to GND should be used to minimize voltage droop (holding V_{OUT} constant during the sample interval). Using a capacitor on the OUT terminal will also reduce the TSM9938's small-signal bandwidth as well as band-limiting amplifier noise.

Using the TSM9938 in Bidirectional Load Current Applications

In many battery-powered systems, it is oftentimes necessary to monitor a battery's discharge and charge currents. To perform this function, a bidirectional current-sense amplifier is required. The circuit illustrated in Figure 2 shows how two TSM9938s can be configured as a bidirectional current-sense amplifier. As shown in the figure, the

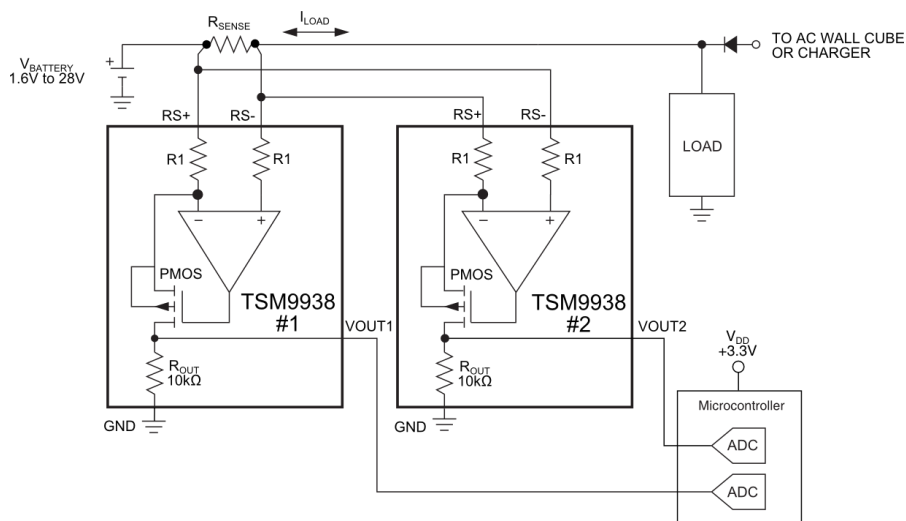

Figure 2: Using Two TSM9938s for Bidirectional Load Current Detection

RS+/RS- input pair of TSM9938 #2 is wired opposite in polarity with respect to the RS+/RS- connections of TSM9938 #1. Current-sense amplifier #1 therefore measures the discharge current and current-sense amplifier #2 measures the charge current. Note that both output voltages are measured with respect to GND. When the discharge current is being measured, V_{OUT1} is active and V_{OUT2} is zero; for the case where charge current is being measured, V_{OUT1} is zero, and V_{OUT2} is active.

PC Board Layout and Power-Supply Bypassing

For optimal circuit performance, the TSM9938 should be in very close proximity to the external current-sense resistor and the pcb tracks from RSENSE to the RS+ and the RS- input terminals of the TSM9938 should be short and symmetric. Also recommended are a ground plane and surface mount resistors and capacitors.

PACKAGE OUTLINE DRAWING

5-Pin SOT23 Package Outline Drawing

(N.B., Drawings are not to scale)

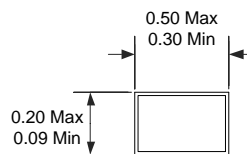
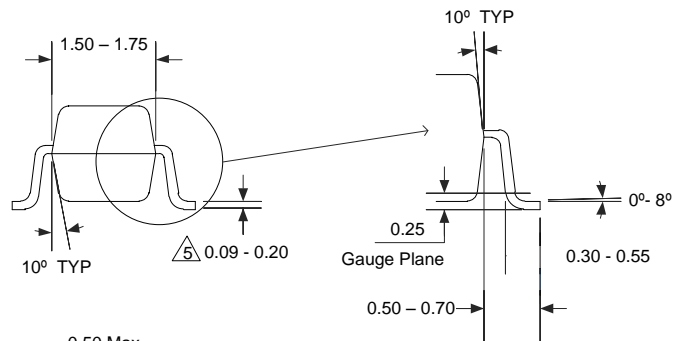
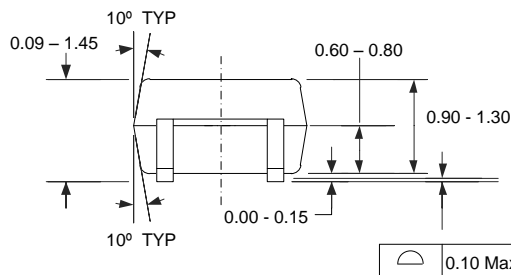
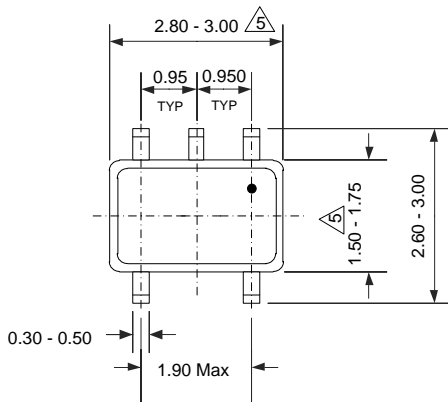

NOTES:

1. Dimensions and tolerances are as per ANSI Y14.5M, 1982.
2. Package surface to be matte finish VDI 11-13.
3. Die is facing up mold and facing down for trim/form, ie, reverse trim/form.
4. The foot length measuring is based on the gauge plane method.
5. Dimensions are exclusive of mold flash and gate burr.
6. Dimensions are exclusive of solder plating.
7. All dimensions are in mm.
8. This part is compliant with EIAJ spec. and JEDEC MO-178 AA
9. Lead span/stand off height/coplanarity are considered as special characteristic.

Information furnished by Touchstone Semiconductor is believed to be accurate and reliable. However, Touchstone Semiconductor does not assume any responsibility for its use nor for any infringements of patents or other rights of third parties that may result from its use, and all information provided by Touchstone Semiconductor and its suppliers is provided on an AS IS basis, WITHOUT WARRANTY OF ANY KIND. Touchstone Semiconductor reserves the right to change product specifications and product descriptions at any time without any advance notice. No license is granted by implication or otherwise under any patent or patent rights of Touchstone Semiconductor. Touchstone Semiconductor assumes no liability for applications assistance or customer product design. Customers are responsible for their products and applications using Touchstone Semiconductor components. To minimize the risk associated with customer products and applications, customers should provide adequate design and operating safeguards. Trademarks and registered trademarks are the property of their respective owners.

Looking for pricing, stock, or lifecycle information?

Click below to explore more details on WIN SOURCE:

 [View TSM9938TEUK+T on WIN SOURCE](#)

 [Silicon Labs](#) Information

Optimize Your Supply Chain with WIN SOURCE Solutions

-  Global Sourcing Solution
-  Obsolete Management
-  Cost Control Management
-  Shortage Management
-  Alternative Solution
-  Excess Inventory Management