



THE DATASHEET OF MAX4610EPD





Low-Voltage, Quad, SPST CMOS Analog Switches

MAX4610/MAX4611/MAX4612

General Description

The MAX4610/MAX4611/MAX4612 are quad, low-voltage, single-pole/single-throw (SPST) analog switches. On-resistance (100Ω, max) is matched between switches to 4Ω, max and is flat (4Ω, max) over the specified signal range. Each switch handles V₊ to GND analog signal levels. Maximum off-leakage current is only 1nA at T_A = +25°C and 2nA at T_A = +85°C.

The MAX4610 has four normally open (NO) switches, and the MAX4611 has four normally closed (NC) switches. The MAX4612 has two NO switches and two NC switches. These CMOS switches operate from a single +2V to +12V supply. All digital inputs have +0.8V and +2.4V logic thresholds, ensuring TTL/CMOS-logic compatibility when using a single +5V supply.

Applications

- Battery-Operated Equipment
- Audio/Video Signal Routing
- Low-Voltage Data-Acquisition Systems
- Sample-and-Hold Circuits
- Communication Circuits

Features

- ◆ Offered in Automotive Temperature Range (-40°C to +125°C)
- ◆ Guaranteed On-Resistance
100Ω max (5V Supply)
46Ω max (12V Supply)
- ◆ Guaranteed Match Between Channels (4Ω, max)
- ◆ Guaranteed Flatness Over Signal Range (18Ω, max)
- ◆ Off-Leakage Current Over Temperature
< 2nA at T_A = +85°C
- ◆ > 2kV ESD Protection per Method 3015.7
- ◆ Rail-to-Rail Signal Handling
- ◆ TTL/CMOS-Logic Compatible

Ordering Information

PART	TEMP RANGE	PIN-PACKAGE
MAX4610CUD+	0°C to +70°C	14 TSSOP
MAX4610CSD+	0°C to +70°C	14 Narrow SO
MAX4610CPD+	0°C to +70°C	14 Plastic DIP
MAX4610C/D+	0°C to +70°C	Dice*
MAX4610EGE+	-40°C to +85°C	16 QFN-EP**
MAX4610EUD+	-40°C to +85°C	14 TSSOP
MAX4610ESD+	-40°C to +85°C	14 Narrow SO
MAX4610EPD+	-40°C to +85°C	14 Plastic DIP
MAX4610ASD+	-40°C to +125°C	14 Narrow SO

Ordering Information continued at end of data sheet.

*Contact factory for dice specifications.

**EP = Exposed pad.

+Denotes a lead(Pb)-free/RoHS-compliant package.

Pin Configurations/Truth Tables

TOP VIEW

TSSOP/SO/DIP

INPUT	SWITCH STATE
LOW	OFF
HIGH	ON

QFN

MAX4611/MAX4612 Pin Configurations/Truth Tables appear at end of data sheet.

**EP = EXPOSED PAD
CONNECT EP TO V+



Low-Voltage, Quad, SPST CMOS Analog Switches

ABSOLUTE MAXIMUM RATINGS

(Voltages referenced to GND.)

V+	-0.3V to +13V
IN_, COM_, NO_, NC_ (Note 1)	-0.3V to (V+ + 0.3V)
Continuous Current (any terminal) (pulsed at 1ms, 10% duty cycle)	20mA
Peak Current (any terminal) (pulsed at 1ms, 10% duty cycle)	40mA
ESD per Method 3015.7	> 2kV

Continuous Power Dissipation (TA = +70°C)

14-Pin TSSOP (derate 6.3mW/°C above +70°C)	500mW
14-Pin Narrow SO (derate 8.00mW/°C above +70°C)	640mW
14-Pin Plastic DIP (derate 10.00mW/°C above +70°C)	800mW
16-Pin QFN (derate 18.5mW/°C above +70°C)	1481mW

Operating Temperature Ranges

MAX461_C_	0°C to +70°C
MAX461_E_	-40°C to +85°C
MAX461_A_	-40°C to +125°C
Storage Temperature Range	-65°C to +160°C
Lead Temperature (soldering, 10s)	+300°C

Note 1: Signals on NO_, NC_, COM_, or IN_ exceeding V+ or GND are clamped by internal diodes. Limit forward-diode current to maximum current rating.

Stresses beyond those listed under "Absolute Maximum Ratings" may cause permanent damage to the device. These are stress ratings only, and functional operation of the device at these or any other conditions beyond those indicated in the operational sections of the specifications is not implied. Exposure to absolute maximum rating conditions for extended periods may affect device reliability.

ELECTRICAL CHARACTERISTICS—Single +5V Supply

(V+ = +5V ±10%, VIN_H = 2.4V, VIN_L = 0.8V, TA = TMIN to TMAX, unless otherwise noted.)

PARAMETER	SYMBOL	CONDITIONS		MIN	TYP (Note 2)	MAX	UNITS
ANALOG SWITCH							
Analog Signal Range (Note 3)	VCOM_, VNO_, VNC_			0		V+	V
On-Resistance	RON	V+ = 4.5V, ICOM_ = 1mA, VNO_ = VNC_ = 3V	TA = +25°C	70	100		Ω
			TA = TMIN to TMAX			150	
On-Resistance Match Between Channels (Note 4)	ΔRON	V+ = 4.5V, ICOM_ = 1mA, VNO_ = VNC_ = 3V	TA = +25°C	1.0	5		Ω
			TA = TMIN to TMAX			8	
On-Resistance Flatness (Note 5)	RFLAT(ON)	V+ = 4.5V; ICOM_ = 1mA; VNO_ = VNC_ = 3V, 2V, 1V	TA = +25°C	12	22		Ω
			TA = TMIN to TMAX			28	
NO_ or NC_ Off-Leakage Current (Note 6)	INO(OFF)	V+ = 5.5V; VCOM_ = 1V, 4.5V; VNO_ = 4.5V, 1V	TA = +25°C	-0.1	+0.1		nA
			TA = -40°C to +85°C	-2	+2		
			TA = -40°C to +125°C	-30	+30		
COM_ Off-Leakage Current (Note 6)	ICOM(OFF)	V+ = 5.5V; VCOM_ = 1V, 4.5V; VNO_ = VNC_ = 4.5V, 1V	TA = +25°C	-0.1	+0.1		nA
			TA = -40°C to +85°C	-2	+2		
			TA = -40°C to +125°C	-30	+30		
COM_ On-Leakage Current (Note 6)	ICOM(ON)	V+ = 5.5V; VCOM_ = 1V, 4.5V; VNO_ = VNC_ = 1V, 4.5V, or floating	TA = +25°C	-0.2	+0.2		nA
			TA = -40°C to +85°C	-4	+4		
			TA = -40°C to +125°C	-30	+30		

Low-Voltage, Quad, SPST CMOS Analog Switches

MAX4610/MAX4611/MAX4612

ELECTRICAL CHARACTERISTICS—Single +5V Supply (continued)

(V+ = +5V ±10%, V_{IN_H} = 2.4V, V_{IN_L} = 0.8V, T_A = T_{MIN} to T_{MAX}, unless otherwise noted.)

PARAMETER	SYMBOL	CONDITIONS	MIN	TYP (Note 2)	MAX	UNITS
LOGIC INPUT						
Input Current with Input-Voltage High	I _{IN_H}	V _{IN_} = 2.4V, all others = 0.8V	-0.1	±0.001	+0.1	μA
Input Current with Input-Voltage Low	I _{IN_L}	V _{IN_} = 0.8V, all others = 2.4V	-0.1	±0.001	+0.1	μA
Input High Voltage	V _{IN_H}		2.4	1.5		V
Input Low Voltage	V _{IN_L}			1.4	0.8	V
DYNAMIC (Note 3)						
Turn-On Time	t _{ON}	V _{COM_} = 3V, Figure 2	T _A = +25°C	35	65	ns
			T _A = T _{MIN} to T _{MAX}			
Turn-Off Time	t _{OFF}	V _{COM_} = 3V, Figure 2	T _A = +25°C	15	28	ns
			T _A = T _{MIN} to T _{MAX}			
On-Channel Bandwidth	BW	Signal = 0dBm, Figure 4, 50Ω in and out	T _A = +25°C	300		MHz
Charge Injection	V _{CTE}	C _L = 1.0nF, V _{GEN} = 0, R _{GEN} = 0, Figure 3	T _A = +25°C	1	5	pC
Off-Isolation (Note 7)	V _{ISO}	R _L = 50Ω, C _L = 5pF, f = 1MHz, Figure 4	T _A = +25°C	-60		dB
Crosstalk (Note 8)	V _{CT}	R _L = 50Ω, C _L = 5pF, f = 1MHz, Figure 5	T _A = +25°C	-80		dB
NO_ or NC_ Capacitance	C _(OFF)	f = 1MHz, Figure 6	T _A = +25°C	16		pF
COM_ Off-Capacitance	C _{COM(OFF)}	f = 1MHz, Figure 6	T _A = +25°C	16		pF
COM_ On-Capacitance	C _{COM(ON)}	f = 1MHz, Figure 6	T _A = +25°C	23		pF
Total Harmonic Distortion	THD	600Ω IN and OUT, 20Hz to 20kHz, 2V _{P-P}	T _A = +25°C	0.009		%
SUPPLY						
Power-Supply Range			2		12	V
Supply Current	I ₊	V _{IN} = 0 or V ₊ , all switches on or off	-1	±0.001	+1	μA

Low-Voltage, Quad, SPST CMOS Analog Switches

ELECTRICAL CHARACTERISTICS—Single +3V Supply

(V+ = +3V, V_{IN_H} = 2.4V, V_{IN_L} = 0.5V, T_A = T_{MIN} to T_{MAX}, unless otherwise noted.)

PARAMETER	SYMBOL	CONDITIONS		MIN	TYP (Note 2)	MAX	UNITS	
ANALOG SWITCH								
Analog Signal Range (Note 3)	V _{COM_} , V _{NO_} , V _{NC_}			0		V+	V	
On-Resistance	R _{ON}	V+ = 2.7V, I _{COM_} = 1mA, V _{NO_} = V _{NC_} = 1V	T _A = +25°C	175	360		Ω	
			T _A = T _{MIN} to T _{MAX}			450		
On-Resistance Match Between Channels (Note 4)	ΔR _{ON}	V+ = 2.7V, I _{COM_} = 1mA, V _{NO_} = V _{NC_} = 1V	T _A = +25°C	2	10		Ω	
			T _A = T _{MIN} to T _{MAX}			20		
NO __ or NC __ Off-Leakage Current (Notes 3, 6)	I _{NO(OFF)}	V+ = 3.6V, V _{COM_} = 0.5V, 3V; V _{NO_} = V _{NC_} = 3V, 0.5V	T _A = +25°C	-0.1	+0.1		nA	
			T _A = -40°C to +85°C	-2	+2			
			T _A = -40°C to +125°C	-30	+30			
COM __ Off-Leakage Current (Notes 3, 6)	I _{COM(OFF)}	V+ = 3.6V, V _{COM_} = 0.5V, 3V; V _{NO_} = V _{NC_} = 3V, 0.5V	T _A = +25°C	-0.1	+0.1		nA	
			T _A = -40°C to +85°C	-2	+2			
			T _A = -40°C to +125°C	-30	+30			
COM __ On-Leakage Current (Notes 3, 6)	I _{COM(ON)}	V+ = 3.6V, V _{COM_} = 0.5V, 3V; V _{NO_} = V _{NC_} = 0.5V, 3V, or floating	T _A = +25°C	-0.2	+0.2		nA	
			T _A = -40°C to +85°C	-4	+4			
			T _A = -40°C to +125°C	-30	+30			
LOGIC INPUTS								
Input High Voltage	V _{IN_H}			2.4	1.0		V	
Input Low Voltage	V _{IN_L}				1.0	0.5	V	
DYNAMIC (Note 3)								
Turn-On Time	t _{ON}	V _{COM_} = 1.5V, Figure 2	T _A = +25°C	50	100		ns	
			T _A = -40°C to +85°C			120		
			T _A = -40°C to +125°C			140		
Turn-Off Time	t _{OFF}	V _{COM_} = 1.5V, Figure 2	T _A = +25°C	30	47		ns	
			T _A = T _{MIN} to T _{MAX}			60		

Low-Voltage, Quad, SPST CMOS Analog Switches

MAX4610/MAX4611/MAX4612

ELECTRICAL CHARACTERISTICS—Single +12V Supply

(V+ = +12V, V_{IN_H} = 4V, V_{IN_L} = 0.8V, T_A = T_{MIN} to T_{MAX}, unless otherwise noted.)

PARAMETER	SYMBOL	CONDITIONS		MIN	TYP (Note 2)	MAX	UNITS
ANALOG SWITCH							
Analog Signal Range (Note 3)	V _{COM_} , V _{NO_} , V _{NC_}			0		V+	V
On-Resistance	R _{ON}	V+ = 12V, I _{COM} = 2mA, V _{NO_} = V _{NC_} = 10V	T _A = +25°C	30	45		Ω
			T _A = T _{MIN} to T _{MAX}			60	
LOGIC INPUTS							
Input High Voltage	V _{IN_H}			4.0	2.8		V
Input Low Voltage	V _{IN_L}				2.5	0.8	V
SUPPLY							
Positive Supply Current	I+	V _{IN_} = 0 or V+, all switches on or off		-1	±0.001	+1	μA

Note 2: The algebraic convention, where the most negative value is a minimum and the most positive value a maximum, is used in this data sheet.

Note 3: Guaranteed by design.

Note 4: ΔR_{ON} = R_{ON} (max) - R_{ON} (min).

Note 5: Flatness is defined as the difference between the maximum and minimum value of on-resistance as measured over the specified analog signal range.

Note 6: Leakage parameters are 100% tested at maximum-rated hot temperature and guaranteed by correlation at +25°C.

Note 7: Off-Isolation = 20log₁₀ (V_{COM_} / V_{NO_}), V_{COM_} = output, V_{NO_} = input to off switch.

Note 8: Between any two switches.

Low-Voltage, Quad, SPST CMOS Analog Switches

Typical Operating Characteristics

($T_A = +25^\circ\text{C}$, unless otherwise noted.)

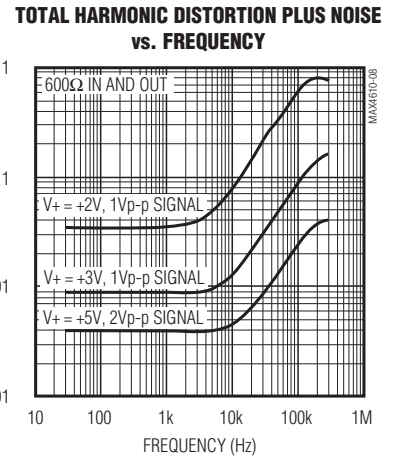
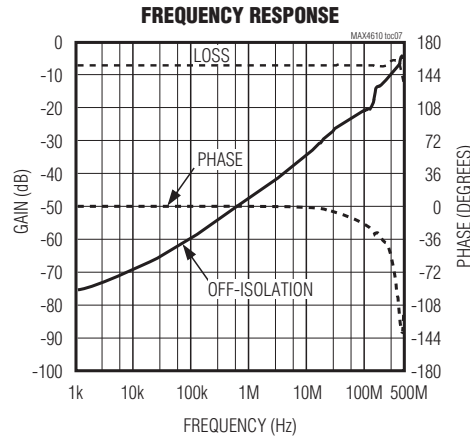
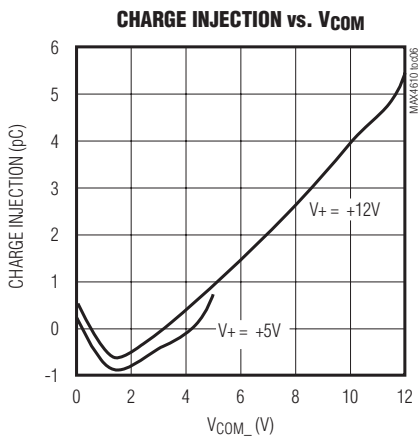
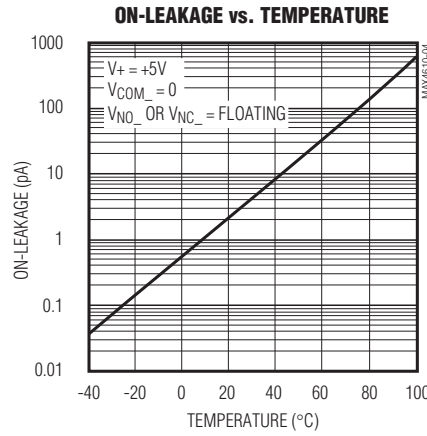
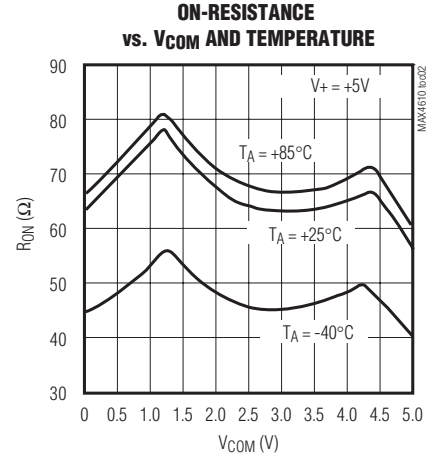
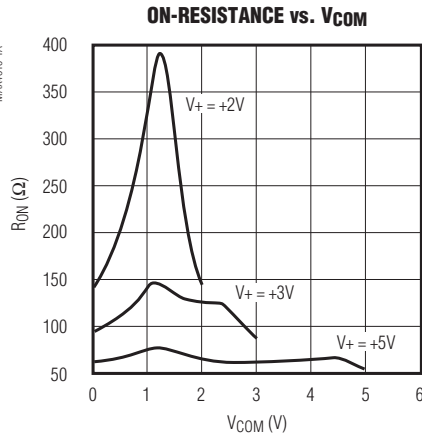

Low-Voltage, Quad, SPST CMOS Analog Switches

Pin Description

PIN						NAME	FUNCTION
MAX4610		MAX4611		MAX4612			
TSSOP/SO/ DIP	QFN	TSSOP/SO/DIP	QFN	TSSOP/SO/DIP	QFN		
1, 3, 8, 11	1, 3, 8, 11	—	—	—	—	NO1–NO4	Analog Switch Normally Open Terminals
—	—	1, 3, 8, 11	1, 3, 8, 11	—	—	NC1–NC4	Analog Switch Normally Closed Terminals
—	—	—	—	1, 8	1, 8	NO1, NO3	Analog Switch Normally Open Terminals
—	—	—	—	3, 11	3, 11	NC2, NC4	Analog Switch Normally Closed Terminals
2, 4, 9, 10	2, 4, 9, 10	2, 4, 9, 10	2, 4, 9, 10	2, 4, 9, 10	2, 4, 9, 10	COM1–COM4	Analog Switch Common Terminals
13, 5, 6, 12	14, 5, 6, 13	13, 5, 6, 12	14, 5, 6, 13	13, 5, 6, 12	14, 5, 6, 13	IN1–IN4	Logic-Control Digital Input
7	7	7	7	7	7	GND	Ground. Connect to digital ground.
—	12, 15	—	12, 15	—	12, 15	N.C.	No Connection. Not internally connected.
14	16	14	16	14	16	V+	Positive Analog and Digital-Supply Voltage Input. Internally connected to substrate.
—	—	—	—	—	—	EP	Exposed Pad (QFN only). Connect to V+.

MAX4610/MAX4611/MAX4612

Applications Information

Power-Supply Sequencing and Overvoltage Protection

Do not exceed the absolute maximum ratings, because stresses beyond the listed ratings may cause permanent damage to the devices.

Proper power-supply sequencing is recommended for all CMOS devices. Always apply V+ before applying analog signals or logic inputs, especially if the analog or logic signals are not current limited. If this sequencing is not possible, and if the analog or logic inputs are not current limited to 20mA, add a small-signal diode (D1) as shown in Figure 1. If the analog signal can dip below GND, add D2. Adding protection diodes reduces the analog signal range to a diode drop (about 0.7V) below V+ (for D1), and to a diode drop above ground (for D2). Leakage is unaffected by adding the diodes. On-resistance increases by a small amount at low supply voltages. Maximum supply voltage (V+) must not exceed 13V.

Adding protection diodes causes the logic thresholds to be shifted relative to the power-supply rails. This can be



Figure 1. Overvoltage Protection Using Two External Blocking Diodes

significant when low supply voltages (+5V or less) are used. With a +5V supply, TTL compatibility is not guaranteed when protection diodes are added. Driving IN1 and IN2 all the way to the supply rails (i.e., to a diode drop higher than the V+ pin, or to a diode drop lower than the GND pin) is always acceptable.

Low-Voltage, Quad, SPST CMOS Analog Switches

Protection diodes D1 and D2 also protect against some overvoltage situations. With Figure 1's circuit, if the supply voltage is below the absolute maximum rating, and if a fault voltage up to the absolute maximum rating is applied to an analog signal pin, no damage will result.

Operating Considerations for High-Voltage Supply

The MAX4610/MAX4611/MAX4612 are pin-compatible with the industry-standard 74HC4066 and the MAX4066, and are optimized for +5V single-supply operation. The MAX4610 family is capable of +12V

single-supply operation with some precautions. The absolute maximum rating for V+ is +13.2V (referenced to GND). When operating near this region, bypass V+ with a minimum 0.1µF capacitor to ground as close to the IC as possible.

Caution: The absolute maximum V+ to V- differential voltage is 13.0V. Typical ±6V or 12V supplies with ±10% tolerances can be as high as 13.2V. This voltage can damage the MAX4610/MAX4611/MAX4612. Even ±5% tolerance supplies may have overshoot or noise spikes that exceed 13.0V.

Test Circuits/Timing Diagrams



Figure 2. Switching Time



Figure 3. Charge Injection

Low-Voltage, Quad, SPST CMOS Analog Switches

Test Circuits/Timing Diagrams (continued)

MAX4610/MAX4611/MAX4612



Figure 4. Off-Isolation/On-Channel Bandwidth

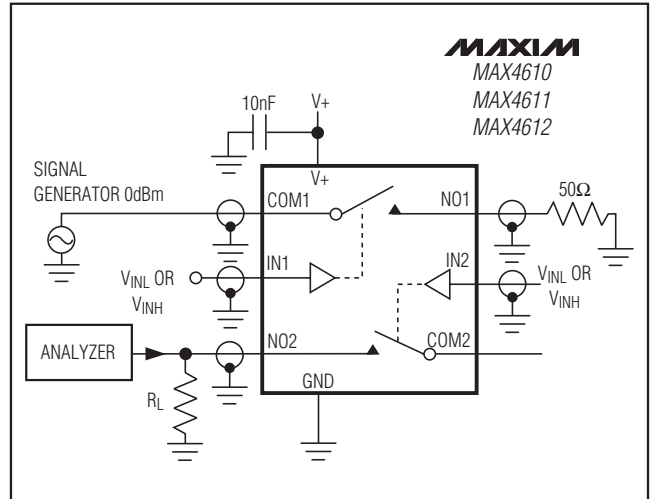

Figure 5. Crosstalk



Figure 6. Channel Off/On-Capacitance

Ordering Information (continued)

PART	TEMP RANGE	PIN-PACKAGE
MAX4611 CUD+	0°C to +70°C	14 TSSOP
MAX4611CSD+	0°C to +70°C	14 Narrow SO
MAX4611CPD+	0°C to +70°C	14 Plastic DIP
MAX4611C/D+	0°C to +70°C	Dice*
MAX4611EGE+	-40°C to +85°C	16 QFN-EP**
MAX4611EUD+	-40°C to +85°C	14 TSSOP
MAX4611ESD+	-40°C to +85°C	14 Narrow SO
MAX4611EPD+	-40°C to +85°C	14 Plastic DIP
MAX4611AUD+	-40°C to +85°C	14 TSSOP
MAX4611ASD+	-40°C to +85°C	14 Narrow SO
MAX4612 CUD+	0°C to +70°C	14 TSSOP
MAX4612CSD+	0°C to +70°C	14 Narrow SO
MAX4612CPD+	0°C to +70°C	14 Plastic DIP
MAX4612C/D+	0°C to +70°C	Dice*
MAX4612EUD+	-40°C to +85°C	14 TSSOP
MAX4612ESD+	-40°C to +85°C	14 Narrow SO
MAX4612EGE+	-40°C to +85°C	16 QFN-EP**
MAX4612EPD+	-40°C to +85°C	14 Plastic DIP
MAX4612AUD+	-40°C to +125°C	14 TSSOP
MAX4612ASD+	-40°C to +125°C	14 Narrow SO

*Contact factory for dice specifications.

**EP = Exposed pad.

+Denotes a lead(Pb)-free/RoHS-compliant package.

Low-Voltage, Quad, SPST CMOS Analog Switches

Pin Configurations/Truth Tables (continued)

TOP VIEW

TSSOP/SO/DIP

INPUT	SWITCH STATE
LOW	ON
HIGH	OFF

QFN

**EP = EXPOSED PAD, CONNECT EP TO V+

TOP VIEW

TSSOP/SO/DIP

INPUT	NO1, NO2	NC3, NC4
LOW	OFF	ON
HIGH	ON	OFF

QFN

**EP = EXPOSED PAD, CONNECT EP TO V+

Package Information

For the latest package outline information, go to www.maxim-ic.com/packages.

PACKAGE TYPE	PACKAGE CODE	DOCUMENT NO.
14 TSSOP	U14+1	21-0066
14 Narrow SO	S14+2	21-0041
14 PDIP	P14+6	21-0043
16 QFN	G1644-1	21-0091

Low-Voltage, Quad, SPST CMOS Analog Switches

Revision History

REVISION NUMBER	REVISION DATE	DESCRIPTION	PAGES CHANGED
0	1/99	—	—
6	5/09	Added lead-free packaging and added changes to EC table	1-4, 7, 9-13

Maxim cannot assume responsibility for use of any circuitry other than circuitry entirely embodied in a Maxim product. No circuit patent licenses are implied. Maxim reserves the right to change the circuitry and specifications without notice at any time.

Maxim Integrated Products, 120 San Gabriel Drive, Sunnyvale, CA 94086 408-737-7600 _____ 11

Looking for pricing, stock, or lifecycle information?

Click below to explore more details on WIN SOURCE:

- ⊖ [View MAX4610EPD on WIN SOURCE](#)
- ⊖ [Maxim Integrated Information](#)

Optimize Your Supply Chain with WIN SOURCE Solutions

- ✓ Global Sourcing Solution
- ✓ Obsolete Management
- ✓ Cost Control Management
- ✓ Shortage Management
- ✓ Alternative Solution
- ✓ Excess Inventory Management