



**THE DATASHEET OF
74HCT2G14GV,125**



74HC2G14; 74HCT2G14

Dual inverting Schmitt trigger

Rev. 2 — 14 March 2014

Product data sheet

1. General description

The 74HC2G14; 74HCT2G14 is a dual inverter with Schmitt-trigger inputs. Inputs include clamp diodes. This enables the use of current limiting resistors to interface inputs to voltages in excess of V_{CC} . Schmitt trigger inputs transform slowly changing input signals into sharply defined jitter-free output signals.

2. Features and benefits

- Wide supply voltage range from 2.0 V to 6.0 V
- Complies with JEDEC standard no. 7A
- Input levels:
 - ◆ For 74HC2G14: CMOS level
 - ◆ For 74HCT2G14: TTL level
- High noise immunity
- Low power dissipation
- Balanced propagation delays
- Unlimited input rise and fall times
- Multiple package options
- ESD protection:
 - ◆ HBM JESD22-A114E exceeds 2000 V
 - ◆ MM JESD22-A115-A exceeds 200 V
- Specified from $-40\text{ }^{\circ}\text{C}$ to $+85\text{ }^{\circ}\text{C}$ and $-40\text{ }^{\circ}\text{C}$ to $+125\text{ }^{\circ}\text{C}$

3. Applications

- Wave and pulse shaper for highly noisy environments
- Astable multivibrators
- Monostable multivibrators

4. Ordering information

Table 1. Ordering information

Type number	Package			
	Temperature range	Name	Description	Version
74HC2G14GW	-40 °C to +125 °C	SC-88	plastic surface-mounted package; 6 leads	SOT363
74HC2G14GV	-40 °C to +125 °C	SC-74	plastic surface-mounted package (TSOP6); 6 leads	SOT457
74HCT2G14GW	-40 °C to +125 °C	SC-88	plastic surface-mounted package; 6 leads	SOT363
74HCT2G14GV	-40 °C to +125 °C	SC-74	plastic surface-mounted package (TSOP6); 6 leads	SOT457

5. Marking

Table 2. Marking

Type number	Marking code ^[1]
74HC2G14GW	HK
74HC2G14GV	H14
74HCT2G14GW	TK
74HCT2G14GV	T14

[1] The pin 1 indicator is located on the lower left corner of the device, below the marking code.

6. Functional diagram

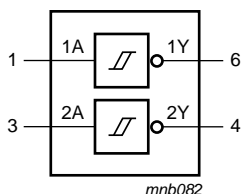

Fig 1. Logic symbol

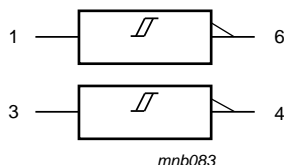

Fig 2. IEC logic symbol

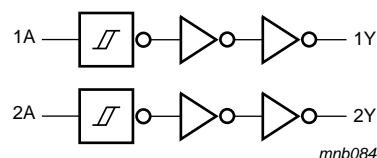

Fig 3. Logic diagram

7. Pinning information

7.1 Pinning

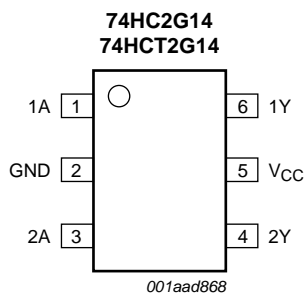

Fig 4. Pin configuration

7.2 Pin description

Table 3. Pin description

Symbol	Pin	Description
1A	1	data input
GND	2	ground (0 V)
2A	3	data input
2Y	4	data output
V _{CC}	5	supply voltage
1Y	6	data output

8. Functional description

Table 4. Function table^[1]

Input	Output
nA	nY
L	H
H	L

[1] H = HIGH voltage level;
L = LOW voltage level.

9. Limiting values

Table 5. Limiting values

In accordance with the Absolute Maximum Rating System (IEC 60134). Voltages are referenced to GND (ground = 0 V).

Symbol	Parameter	Conditions	Min	Max	Unit
V_{CC}	supply voltage		-0.5	+7.0	V
I_{IK}	input clamping current	$V_I < -0.5\text{ V}$ or $V_I > V_{CC} + 0.5\text{ V}$	[1]	-	±20 mA
I_{OK}	output clamping current	$V_O < -0.5\text{ V}$ or $V_O > V_{CC} + 0.5\text{ V}$	[1]	-	±20 mA
I_O	output current	$V_O = -0.5\text{ V}$ to $V_{CC} + 0.5\text{ V}$	[1]	-	±25 mA
I_{CC}	supply current		[1]	-	+50 mA
I_{GND}	ground current		[1]	-	-50 mA
T_{stg}	storage temperature		-65	+150	°C
P_{tot}	total power dissipation		[2]	-	250 mW

[1] The minimum input and output voltage ratings may be exceeded if the input and output current ratings are observed.

[2] For SC-88 and SC-74 packages: above 87.5 °C the value of P_{tot} derates linearly with 4.0 mW/K.

10. Recommended operating conditions

Table 6. Recommended operating conditions

Symbol	Parameter	Conditions	Min	Typ	Max	Unit
Type 74HC2G14						
V_{CC}	supply voltage		2.0	5.0	6.0	V
V_I	input voltage		0	-	V_{CC}	V
V_O	output voltage		0	-	V_{CC}	V
T_{amb}	ambient temperature		-40	+25	+125	°C
Type 74HCT2G14						
V_{CC}	supply voltage		4.5	5.0	5.5	V
V_I	input voltage		0	-	V_{CC}	V
V_O	output voltage		0	-	V_{CC}	V
T_{amb}	ambient temperature		-40	+25	+125	°C

11. Static characteristics

Table 7. Static characteristics for 74HC2G14

At recommended operating conditions; voltages are referenced to GND (ground = 0 V).

Symbol	Parameter	Conditions	Min	Typ	Max	Unit
T_{amb} = 25 °C						
V _{OH}	HIGH-level output voltage	V _I = V _{T+} or V _{T-}				
		I _O = -20 μA; V _{CC} = 2.0 V	1.9	2.0	-	V
		I _O = -20 μA; V _{CC} = 4.5 V	4.4	4.5	-	V
		I _O = -20 μA; V _{CC} = 6.0 V	5.9	6.0	-	V
		I _O = -4.0 mA; V _{CC} = 4.5 V	4.18	4.32	-	V
		I _O = -5.2 mA; V _{CC} = 6.0 V	5.68	5.81	-	V
V _{OL}	LOW-level output voltage	V _I = V _{T+} or V _{T-}				
		I _O = 20 μA; V _{CC} = 2.0 V	-	0	0.1	V
		I _O = 20 μA; V _{CC} = 4.5 V	-	0	0.1	V
		I _O = 20 μA; V _{CC} = 6.0 V	-	0	0.1	V
		I _O = 4.0 mA; V _{CC} = 4.5 V	-	0.15	0.26	V
		I _O = 5.2 mA; V _{CC} = 6.0 V	-	0.16	0.26	V
I _I	input leakage current	V _I = GND or V _{CC} ; V _{CC} = 6.0 V	-	-	±0.1	μA
I _{CC}	supply current	V _I = GND or V _{CC} ; I _O = 0 μA; V _{CC} = 6.0 V	-	-	1.0	μA
C _I	input capacitance		-	2.0	-	pF
T_{amb} = -40 °C to +85 °C						
V _{OH}	HIGH-level output voltage	V _I = V _{T+} or V _{T-}				
		I _O = -20 μA; V _{CC} = 2.0 V	1.9	-	-	V
		I _O = -20 μA; V _{CC} = 4.5 V	4.4	-	-	V
		I _O = -20 μA; V _{CC} = 6.0 V	5.9	-	-	V
		I _O = -4.0 mA; V _{CC} = 4.5 V	4.13	-	-	V
		I _O = -5.2 mA; V _{CC} = 6.0 V;	5.63	-	-	V
V _{OL}	LOW-level output voltage	V _I = V _{T+} or V _{T-}				
		I _O = 20 μA; V _{CC} = 2.0 V	-	-	0.1	V
		I _O = 20 μA; V _{CC} = 4.5 V	-	-	0.1	V
		I _O = 20 μA; V _{CC} = 6.0 V	-	-	0.1	V
		I _O = 4.0 mA; V _{CC} = 4.5 V	-	-	0.33	V
		I _O = 5.2 mA; V _{CC} = 6.0 V	-	-	0.33	V
I _I	input leakage current	V _I = GND or V _{CC} ; V _{CC} = 6.0 V	-	-	±1.0	μA
I _{CC}	supply current	V _I = GND or V _{CC} ; I _O = 0 μA; V _{CC} = 6.0 V	-	-	10.0	μA

Table 7. Static characteristics for 74HC2G14 ...continued

At recommended operating conditions; voltages are referenced to GND (ground = 0 V).

Symbol	Parameter	Conditions	Min	Typ	Max	Unit
T_{amb} = -40 °C to +125 °C						
V _{OH}	HIGH-level output voltage	V _I = V _{T+} or V _{T-}				
		I _O = -20 μA; V _{CC} = 2.0 V	1.9	-	-	V
		I _O = -20 μA; V _{CC} = 4.5 V	4.4	-	-	V
		I _O = -20 μA; V _{CC} = 6.0 V	5.9	-	-	V
		I _O = -4.0 mA; V _{CC} = 4.5 V	3.7	-	-	V
		I _O = -5.2 mA; V _{CC} = 6.0 V;	5.2	-	-	V
V _{OL}	LOW-level output voltage	V _I = V _{T+} or V _{T-}				
		I _O = 20 μA; V _{CC} = 2.0 V	-	-	0.1	V
		I _O = 20 μA; V _{CC} = 4.5 V	-	-	0.1	V
		I _O = 20 μA; V _{CC} = 6.0 V	-	-	0.1	V
		I _O = 4.0 mA; V _{CC} = 4.5 V	-	-	0.4	V
		I _O = 5.2 mA; V _{CC} = 6.0 V	-	-	0.4	V
I _I	input leakage current	V _I = GND or V _{CC} ; V _{CC} = 6.0 V	-	-	±1.0	μA
I _{CC}	supply current	V _I = GND or V _{CC} ; I _O = 0 μA; V _{CC} = 6.0 V	-	-	20.0	μA

Table 8. Static characteristics for 74HCT2G14

At recommended operating conditions; voltages are referenced to GND (ground = 0 V).

Symbol	Parameter	Conditions	Min	Typ	Max	Unit
T_{amb} = 25 °C						
V _{OH}	HIGH-level output voltage	V _I = V _{T+} or V _{T-}				
		I _O = -20 μA; V _{CC} = 4.5 V	4.4	4.5	-	V
		I _O = -4.0 mA; V _{CC} = 4.5 V	4.18	4.32	-	V
V _{OL}	LOW-level output voltage	V _I = V _{T+} or V _{T-}				
		I _O = 20 μA; V _{CC} = 4.5 V	-	0	0.1	V
		I _O = 4.0 mA; V _{CC} = 4.5 V	-	0.15	0.26	V
I _I	input leakage current	V _I = GND or V _{CC} ; V _{CC} = 5.5 V	-	-	±0.1	μA
I _{CC}	supply current	V _I = GND or V _{CC} ; I _O = 0 μA; V _{CC} = 5.5 V	-	-	1.0	μA
ΔI _{CC}	additional supply current	V _I = V _{CC} - 2.1 V; V _{CC} = 4.5 V to 5.5 V; I _O = 0 μA	-	-	300	μA
C _I	input capacitance		-	2.0	-	pF

Table 8. Static characteristics for 74HCT2G14 ...continued

At recommended operating conditions; voltages are referenced to GND (ground = 0 V).

Symbol	Parameter	Conditions	Min	Typ	Max	Unit
$T_{amb} = -40\text{ °C to }+85\text{ °C}$						
V_{OH}	HIGH-level output voltage	$V_I = V_{T+}$ or V_{T-}				
		$I_O = -20\text{ }\mu\text{A}; V_{CC} = 4.5\text{ V}$	4.4	-	-	V
		$I_O = -4.0\text{ mA}; V_{CC} = 4.5\text{ V}$	4.13	-	-	V
V_{OL}	LOW-level output voltage	$V_I = V_{T+}$ or V_{T-}				
		$I_O = 20\text{ }\mu\text{A}; V_{CC} = 4.5\text{ V}$	-	-	0.1	V
		$I_O = 4.0\text{ mA}; V_{CC} = 4.5\text{ V}$	-	-	0.33	V
I_I	input leakage current	$V_I = \text{GND}$ or $V_{CC}; V_{CC} = 5.5\text{ V}$	-	-	± 1.0	μA
I_{CC}	supply current	$V_I = \text{GND}$ or $V_{CC}; I_O = 0\text{ }\mu\text{A}; V_{CC} = 5.5\text{ V}$	-	-	10.0	μA
ΔI_{CC}	additional supply current	$V_I = V_{CC} - 2.1\text{ V}; V_{CC} = 4.5\text{ V to }5.5\text{ V}; I_O = 0\text{ }\mu\text{A}$	-	-	375	μA
$T_{amb} = -40\text{ °C to }+125\text{ °C}$						
V_{OH}	HIGH-level output voltage	$V_I = V_{T+}$ or V_{T-}				
		$I_O = -20\text{ }\mu\text{A}; V_{CC} = 4.5\text{ V}$	4.4	-	-	V
		$I_O = -4.0\text{ mA}; V_{CC} = 4.5\text{ V}$	3.7	-	-	V
V_{OL}	LOW-level output voltage	$V_I = V_{T+}$ or V_{T-}				
		$I_O = 20\text{ }\mu\text{A}; V_{CC} = 4.5\text{ V}$	-	-	0.1	V
		$I_O = 4.0\text{ mA}; V_{CC} = 4.5\text{ V}$	-	-	0.4	V
I_I	input leakage current	$V_I = \text{GND}$ or $V_{CC}; V_{CC} = 5.5\text{ V}$	-	-	± 1.0	μA
I_{CC}	supply current	$V_I = \text{GND}$ or $V_{CC}; I_O = 0\text{ }\mu\text{A}; V_{CC} = 5.5\text{ V}$	-	-	20.0	μA
ΔI_{CC}	additional supply current	$V_I = V_{CC} - 2.1\text{ V}; V_{CC} = 4.5\text{ V to }5.5\text{ V}; I_O = 0\text{ }\mu\text{A}$	-	-	410	μA

12. Dynamic characteristics

Table 9. Dynamic characteristics

Voltages are referenced to GND (ground = 0 V); for test circuit see [Figure 6](#).

Symbol	Parameter	Conditions	25 °C			-40 °C to +125 °C			Unit
			Min	Typ	Max	Min	Max (85 °C)	Max (125 °C)	
74HC2G14									
t _{pd}	propagation delay	nA to nY; see Figure 5 [1]							
		V _{CC} = 2.0 V; C _L = 50 pF	-	53	125	-	155	190	ns
		V _{CC} = 4.5 V; C _L = 50 pF	-	16	25	-	31	38	ns
		V _{CC} = 6.0 V; C _L = 50 pF	-	13	21	-	26	32	ns
t _t	transition time	nY; see Figure 5 [2]							
		V _{CC} = 2.0 V; C _L = 50 pF	-	20	75	-	95	110	ns
		V _{CC} = 4.5 V; C _L = 50 pF	-	7	15	-	19	22	ns
		V _{CC} = 6.0 V; C _L = 50 pF	-	5	13	-	16	19	ns
C _{PD}	power dissipation capacitance	V _I = GND to V _{CC} [3]	-	10	-	-	-	-	pF
74HCT2G14									
t _{pd}	propagation delay	nA to nY; see Figure 5 [1]							
		V _{CC} = 4.5 V; C _L = 50 pF	-	21	32	-	40	48	ns
t _t	transition time	nY; see Figure 5 [2]							
		V _{CC} = 4.5 V; C _L = 50 pF	-	6	15	-	19	22	ns
C _{PD}	power dissipation capacitance	V _I = GND to V _{CC} - 1.5 V [3]	-	10	-	-	-	-	pF

[1] t_{pd} is the same as t_{PLH} and t_{PHL}

[2] t_t is the same as t_{TLH} and t_{THL}

[3] C_{PD} is used to determine the dynamic power dissipation (P_D in μW).

$$P_D = C_{PD} \times V_{CC}^2 \times f_i \times N + \Sigma(C_L \times V_{CC}^2 \times f_o) \text{ where:}$$

f_i = input frequency in MHz;

f_o = output frequency in MHz;

C_L = output load capacitance in pF;

V_{CC} = supply voltage in V;

N = number of inputs switching;

Σ(C_L × V_{CC}² × f_o) = sum of the outputs.

13. Waveforms

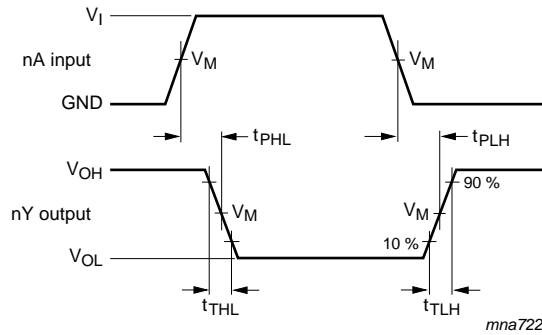

Measurement points are given in [Table 10](#).
 V_{OL} and V_{OH} are typical voltage output levels that occur with the output load.

Fig 5. The data input (nA) to output (nY) propagation delays and output transition times

Table 10. Measurement points

Type	Input			Output
	V_M	V_I	$t_r = t_f$	V_M
74HC2G14	$0.5V_{CC}$	GND to V_{CC}	6.0 ns	$0.5V_{CC}$
74HCT2G14	1.3 V	GND to 3.0 V	6.0 ns	1.3 V

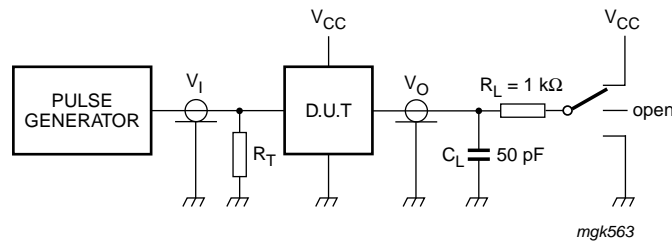

Test data is given in [Table 11](#).
 Definitions test circuit:
 R_L = Load resistance.
 C_L = Load capacitance including jig and probe capacitance.
 R_T = Termination resistance should be equal to output impedance Z_o of the pulse generator.

Fig 6. Load circuitry for switching times

Table 11. Test data

Type	Input		Test
	V_I	t_r, t_f	t_{PHL}, t_{PLH}
74HC2G14	GND to V_{CC}	6 ns	open
74HCT2G14	GND to 3.0 V	6 ns	open

14. Transfer characteristics

Table 12. Transfer characteristics

Voltages are referenced to GND (ground = 0 V); for test circuit see [Figure 6](#).

Symbol	Parameter	Conditions	25 °C			–40 °C to +125 °C			Unit
			Min	Typ	Max	Min	Max (85 °C)	Max (125 °C)	
74HC2G14									
V _{T+}	positive-going threshold voltage	see Figure 7 , Figure 8							
		V _{CC} = 2.0 V	1.00	1.18	1.50	1.00	1.50	1.50	V
		V _{CC} = 4.5 V	2.30	2.60	3.15	2.30	3.15	3.15	V
		V _{CC} = 6.0 V	3.00	3.46	4.20	3.00	4.20	4.20	V
V _{T–}	negative-going threshold voltage	see Figure 7 , Figure 8							
		V _{CC} = 2.0 V	0.30	0.60	0.90	0.30	0.90	0.90	V
		V _{CC} = 4.5 V	1.13	1.47	2.00	1.13	2.00	2.00	V
		V _{CC} = 6.0 V	1.50	2.06	2.60	1.50	2.60	2.60	V
V _H	hysteresis voltage	(V _{T+} – V _{T–}); see Figure 7 , Figure 8 and Figure 9							
		V _{CC} = 2.0 V	0.30	0.60	1.00	0.30	1.00	1.00	V
		V _{CC} = 4.5 V	0.60	1.13	1.40	0.60	1.40	1.40	V
		V _{CC} = 6.0 V	0.80	1.40	1.70	0.80	1.70	1.70	V
74HCT2G14									
V _{T+}	positive-going threshold voltage	see Figure 7 and Figure 8							
		V _{CC} = 4.5 V	1.20	1.58	1.90	1.20	1.90	1.90	V
		V _{CC} = 5.5 V	1.40	1.78	2.10	1.40	2.10	2.10	V
V _{T–}	negative-going threshold voltage	see Figure 7 and Figure 8							
		V _{CC} = 4.5 V	0.50	0.87	1.20	0.50	1.20	1.20	V
		V _{CC} = 5.5 V	0.60	1.11	1.40	0.60	1.40	1.40	V
V _H	hysteresis voltage	(V _{T+} – V _{T–}); see Figure 7 , Figure 8 and Figure 10							
		V _{CC} = 4.5 V	0.40	0.71	-	0.40	-	-	V
		V _{CC} = 5.5 V	0.40	0.67	-	0.40	-	-	V

15. Waveforms transfer characteristics

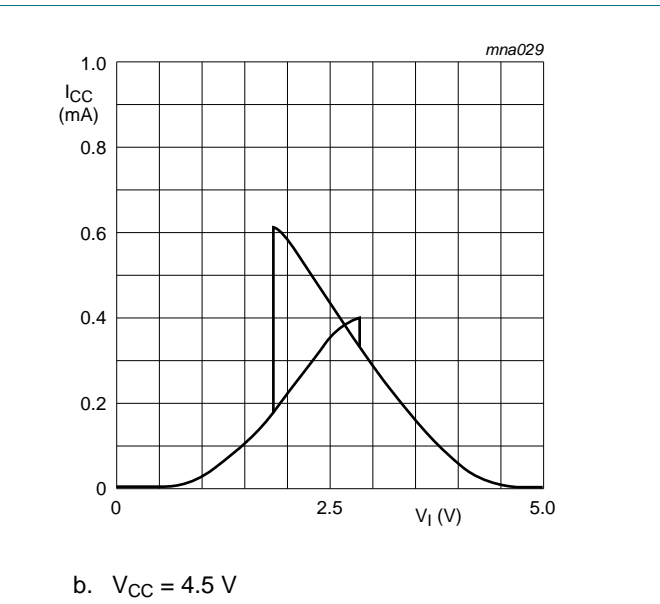
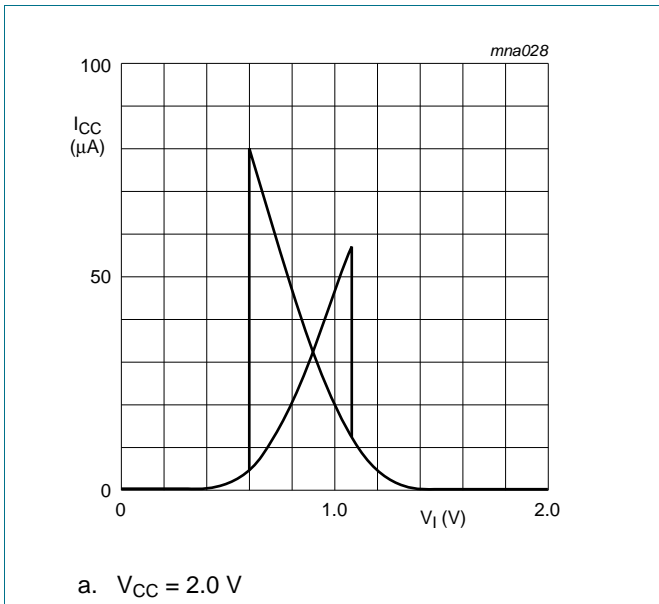
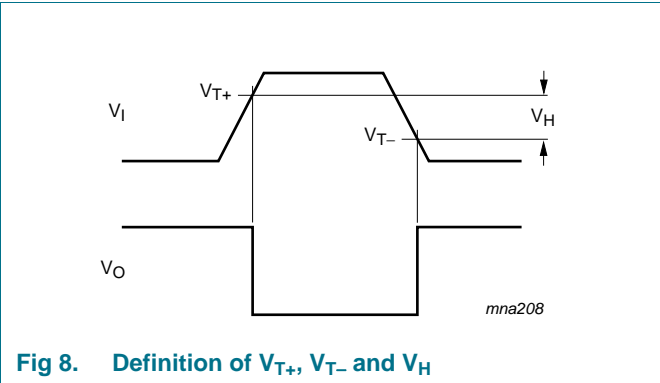
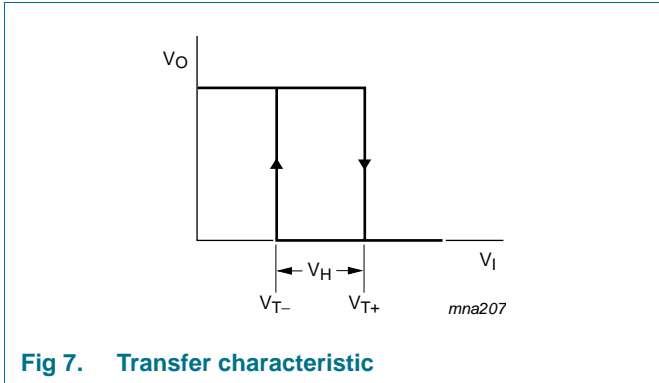

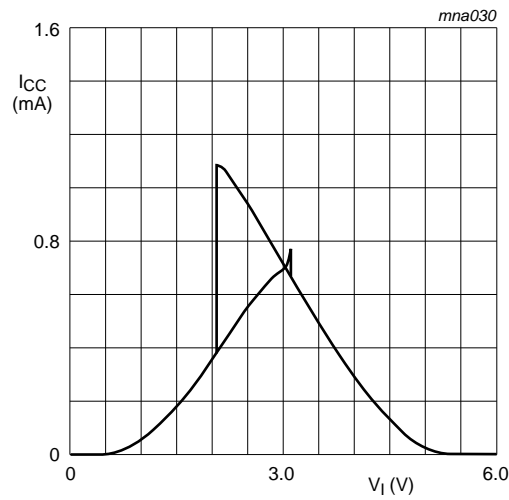

c. $V_{CC} = 6.0$ V

Fig 9. Typical 74HC2G14 transfer characteristics

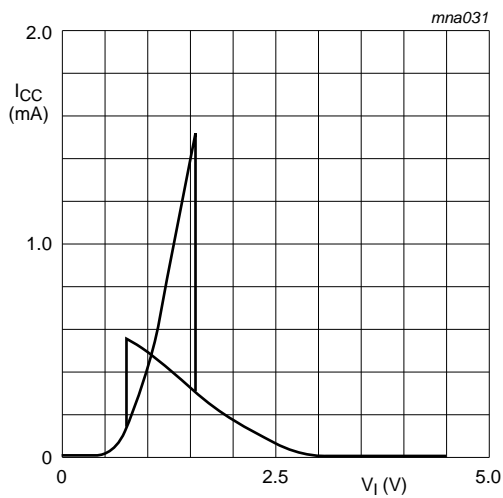

a. $V_{CC} = 4.5$ V.

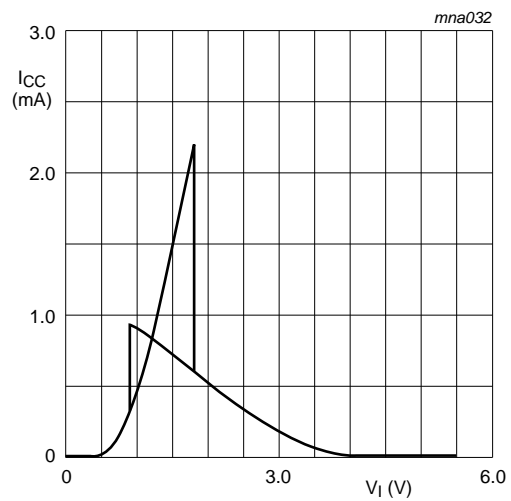

b. $V_{CC} = 5.5$ V.

Fig 10. Typical 74HCT2G14 transfer characteristics

16. Application information

The slow input rise and fall times cause additional power dissipation, this can be calculated using the following formula:

$$P_{\text{add}} = f_i \times (t_r \times \Delta I_{\text{CC(AV)}} + t_f \times \Delta I_{\text{CC(AV)}}) \times V_{\text{CC}} \text{ where:}$$

P_{add} = additional power dissipation (μW);

f_i = input frequency (MHz);

t_r = input rise time (ns); 10 % to 90 %;

t_f = input fall time (ns); 90 % to 10 %;

$\Delta I_{\text{CC(AV)}}$ = average additional supply current (μA).

$\Delta I_{\text{CC(AV)}}$ differs with positive or negative input transitions, as shown in [Figure 11](#) and [Figure 12](#).

An example of a relaxation circuit using the 74HC2G14/74HCT2G14 is shown in [Figure 13](#).

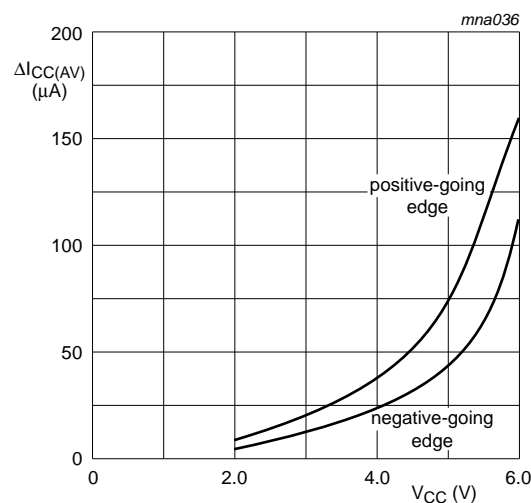

- (1) Positive-going edge.
- (2) Negative-going edge.

Fig 11. $\Delta I_{\text{CC(AV)}}$ as a function of V_{CC} for 74HC2G14; linear change of V_i between $0.1V_{\text{CC}}$ to $0.9V_{\text{CC}}$

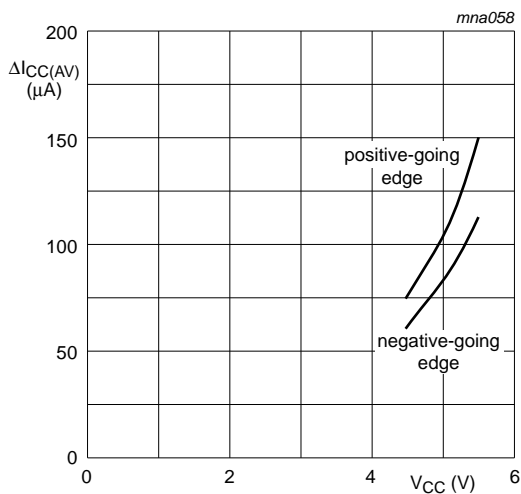

- (1) Positive-going edge.
- (2) Negative-going edge.

Fig 12. $\Delta I_{CC(AV)}$ as a function of V_{CC} for 74HCT2G14; linear change of V_I between $0.1V_{CC}$ to $0.9V_{CC}$

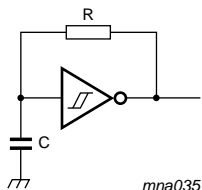

For 74HC2G14: $f = \frac{1}{T} \approx \frac{1}{0.8 \times RC}$

For 74HCT2G14: $f = \frac{1}{T} \approx \frac{1}{0.67 \times RC}$

For K-factor, see [Figure 14](#)

Fig 13. Relaxation oscillator

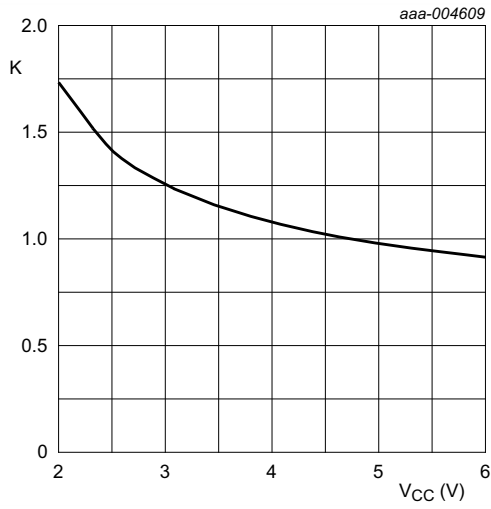

K-factor for 74HC2G14

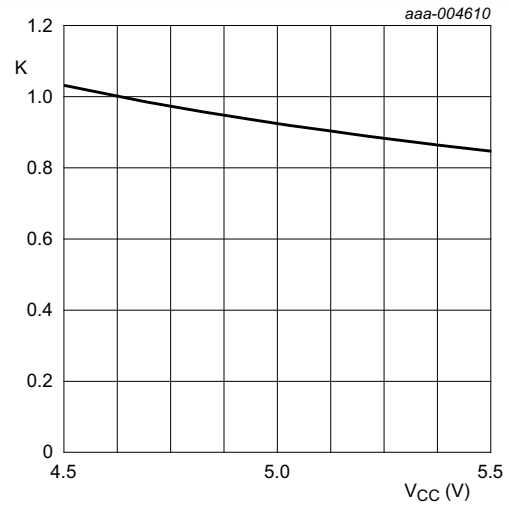

K-factor for 74HCT2G14

Fig 14. Typical K-factor for relaxation oscillator

17. Package outline

Plastic surface-mounted package; 6 leads

SOT363

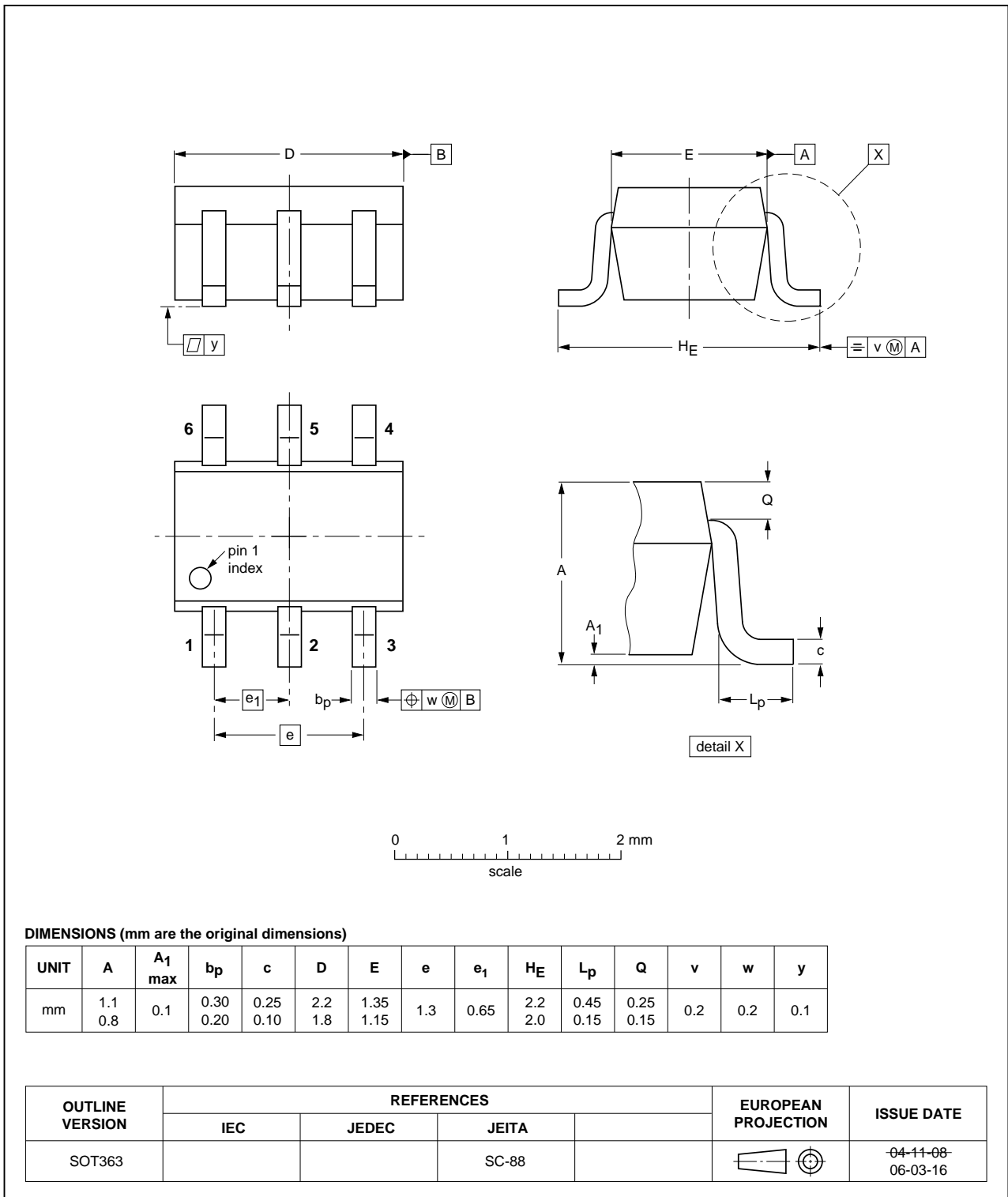

Fig 15. Package outline SOT363 (SC-88)

Plastic surface-mounted package (TSOP6); 6 leads

SOT457

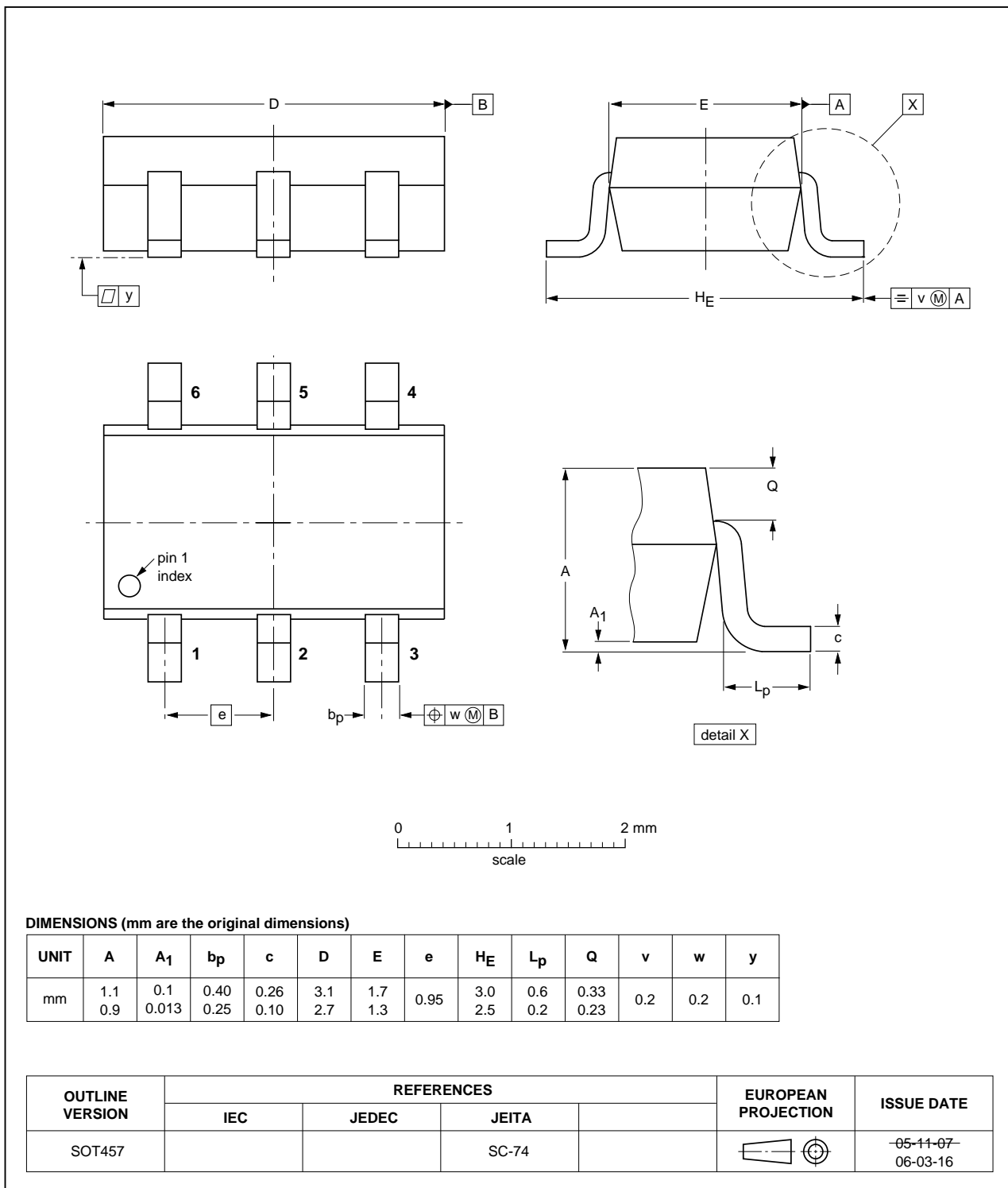

Fig 16. Package outline SOT457 (SC-74)

18. Abbreviations

Table 13. Abbreviations

Acronym	Description
CMOS	Complementary Metal Oxide Semiconductor
ESD	ElectroStatic Discharge
HBM	Human Body Model
MM	Machine Model
DUT	Device Under Test

19. Revision history

Table 14. Revision history

Document ID	Release date	Data sheet status	Change notice	Supersedes
74HC_HCT2G14 v.2	20140314	Product data sheet	-	74HC_HCT2G14 v.1
Modifications:	• Figure 14 added (typical K-factor for relaxation oscillator).			
74HC_HCT2G14 v.1	20061011	Product data sheet	-	-

20. Legal information

20.1 Data sheet status

Document status ^{[1][2]}	Product status ^[3]	Definition
Objective [short] data sheet	Development	This document contains data from the objective specification for product development.
Preliminary [short] data sheet	Qualification	This document contains data from the preliminary specification.
Product [short] data sheet	Production	This document contains the product specification.

[1] Please consult the most recently issued document before initiating or completing a design.

[2] The term 'short data sheet' is explained in section "Definitions".

[3] The product status of device(s) described in this document may have changed since this document was published and may differ in case of multiple devices. The latest product status information is available on the Internet at URL <http://www.nexperia.com>.

20.2 Definitions

Draft — The document is a draft version only. The content is still under internal review and subject to formal approval, which may result in modifications or additions. Nexperia does not give any representations or warranties as to the accuracy or completeness of information included herein and shall have no liability for the consequences of use of such information.

Short data sheet — A short data sheet is an extract from a full data sheet with the same product type number(s) and title. A short data sheet is intended for quick reference only and should not be relied upon to contain detailed and full information. For detailed and full information see the relevant full data sheet, which is available on request via the local Nexperia sales office. In case of any inconsistency or conflict with the short data sheet, the full data sheet shall prevail.

Product specification — The information and data provided in a Product data sheet shall define the specification of the product as agreed between Nexperia and its customer, unless Nexperia and customer have explicitly agreed otherwise in writing. In no event however, shall an agreement be valid in which the Nexperia product is deemed to offer functions and qualities beyond those described in the Product data sheet.

20.3 Disclaimers

Limited warranty and liability — Information in this document is believed to be accurate and reliable. However, Nexperia does not give any representations or warranties, expressed or implied, as to the accuracy or completeness of such information and shall have no liability for the consequences of use of such information. Nexperia takes no responsibility for the content in this document if provided by an information source outside of Nexperia.

In no event shall Nexperia be liable for any indirect, incidental, punitive, special or consequential damages (including - without limitation - lost profits, lost savings, business interruption, costs related to the removal or replacement of any products or rework charges) whether or not such damages are based on tort (including negligence), warranty, breach of contract or any other legal theory.

Notwithstanding any damages that customer might incur for any reason whatsoever, Nexperia's aggregate and cumulative liability towards customer for the products described herein shall be limited in accordance with the *Terms and conditions of commercial sale* of Nexperia.

Right to make changes — Nexperia reserves the right to make changes to information published in this document, including without limitation specifications and product descriptions, at any time and without notice. This document supersedes and replaces all information supplied prior to the publication hereof.

Suitability for use — Nexperia products are not designed, authorized or warranted to be suitable for use in life support, life-critical or safety-critical systems or equipment, nor in applications where failure or malfunction of a Nexperia product can reasonably be expected to result in personal injury, death or severe property or environmental damage. Nexperia and its suppliers accept no liability for inclusion and/or use of Nexperia products in such equipment or applications and therefore such inclusion and/or use is at the customer's own risk.

Applications — Applications that are described herein for any of these products are for illustrative purposes only. Nexperia makes no representation or warranty that such applications will be suitable for the specified use without further testing or modification.

Customers are responsible for the design and operation of their applications and products using Nexperia products, and Nexperia accepts no liability for any assistance with applications or customer product design. It is customer's sole responsibility to determine whether the Nexperia product is suitable and fit for the customer's applications and products planned, as well as for the planned application and use of customer's third party customer(s). Customers should provide appropriate design and operating safeguards to minimize the risks associated with their applications and products.

Nexperia does not accept any liability related to any default, damage, costs or problem which is based on any weakness or default in the customer's applications or products, or the application or use by customer's third party customer(s). Customer is responsible for doing all necessary testing for the customer's applications and products using Nexperia products in order to avoid a default of the applications and the products or of the application or use by customer's third party customer(s). Nexperia does not accept any liability in this respect.

Limiting values — Stress above one or more limiting values (as defined in the Absolute Maximum Ratings System of IEC 60134) will cause permanent damage to the device. Limiting values are stress ratings only and (proper) operation of the device at these or any other conditions above those given in the Recommended operating conditions section (if present) or the Characteristics sections of this document is not warranted. Constant or repeated exposure to limiting values will permanently and irreversibly affect the quality and reliability of the device.

Terms and conditions of commercial sale — Nexperia products are sold subject to the general terms and conditions of commercial sale, as published at <http://www.nexperia.com/profile/terms>, unless otherwise agreed in a valid written individual agreement. In case an individual agreement is concluded only the terms and conditions of the respective agreement shall apply. Nexperia hereby expressly objects to applying the customer's general terms and conditions with regard to the purchase of Nexperia products by customer.

No offer to sell or license — Nothing in this document may be interpreted or construed as an offer to sell products that is open for acceptance or the grant, conveyance or implication of any license under any copyrights, patents or other industrial or intellectual property rights.

Export control — This document as well as the item(s) described herein may be subject to export control regulations. Export might require a prior authorization from competent authorities.

Non-automotive qualified products — Unless this data sheet expressly states that this specific Nexperia product is automotive qualified, the product is not suitable for automotive use. It is neither qualified nor tested in accordance with automotive testing or application requirements. Nexperia accepts no liability for inclusion and/or use of non-automotive qualified products in automotive equipment or applications.

In the event that customer uses the product for design-in and use in automotive applications to automotive specifications and standards, customer (a) shall use the product without Nexperia's warranty of the product for such automotive applications, use and specifications, and (b) whenever customer uses the product for automotive applications beyond

Nexperia's specifications such use shall be solely at customer's own risk, and (c) customer fully indemnifies Nexperia for any liability, damages or failed product claims resulting from customer design and use of the product for automotive applications beyond Nexperia's standard warranty and Nexperia's product specifications.

Translations — A non-English (translated) version of a document is for reference only. The English version shall prevail in case of any discrepancy between the translated and English versions.

20.4 Trademarks

Notice: All referenced brands, product names, service names and trademarks are the property of their respective owners.

21. Contact information

For more information, please visit: <http://www.nexperia.com>



For sales office addresses, please send an email to: salesaddresses@nexperia.com

22. Contents

1	General description	1
2	Features and benefits	1
3	Applications	1
4	Ordering information	2
5	Marking	2
6	Functional diagram	2
7	Pinning information	3
7.1	Pinning	3
7.2	Pin description	3
8	Functional description	3
9	Limiting values	4
10	Recommended operating conditions	4
11	Static characteristics	5
12	Dynamic characteristics	8
13	Waveforms	9
14	Transfer characteristics	10
15	Waveforms transfer characteristics	11
16	Application information	13
17	Package outline	16
18	Abbreviations	18
19	Revision history	18
20	Legal information	19
20.1	Data sheet status	19
20.2	Definitions	19
20.3	Disclaimers	19
20.4	Trademarks	20
21	Contact information	20
22	Contents	21

Looking for pricing, stock, or lifecycle information?

Click below to explore more details on WIN SOURCE:

-  [View 74HCT2G14GV,125 on WIN SOURCE](#)
-  [Nexperia USA Inc. Information](#)

Optimize Your Supply Chain with WIN SOURCE Solutions

-  Global Sourcing Solution
-  Obsolete Management
-  Cost Control Management
-  Shortage Management
-  Alternative Solution
-  Excess Inventory Management